

2-Phase Synchronous Step-Down DC/DC Controller with Diffamp

FEATURES

- PolyPhase® Controller Reduces Input and Output Capacitance and Power Supply Induced Noise
- Wide V_{IN} Range: 4.5V to 38V Operation
- $\pm 0.75\%$, 0.6V Reference Voltage Accuracy
- High Efficiency: Up to 95%
- Programmable Burst Mode® Operation or Stage Shedding™ for Highest Light Load Efficiency
- Active Voltage Positioning (AVP)
- R_{SENSE} or DCR Current Sensing
- Programmable DCR Temperature Compensation
- Phase-Lockable Fixed Frequency: 250kHz to 770kHz
- True Remote Sense Differential Amplifier
- Dual N-Channel MOSFET Synchronous Drive
- V_{OUT} Range: 0.6V to 5V without Differential Amplifier
- V_{OUT} Range: 0.6V to 3.3V with Differential Amplifier
- Adjustable Soft-Start or V_{OUT} Tracking
- Stackable for Up to 12-Phase Operation
- 32-Pin (5mm × 5mm) QFN and 38-Pin TSSOP Packages

APPLICATIONS

- Telecom and Datacom Systems
- Industrial and Medical Instruments
- DC Power Distribution Systems
- Computer Systems

DESCRIPTION

The LTC3856 is a single output, dual channel PolyPhase synchronous step-down DC/DC controller that drives all N-channel power MOSFET stages. This device includes a high speed differential amplifier for remote output voltage sense. Power loss and supply noise are minimized by operating the two controller output stages out-of-phase and up to 12-phase operation can be achieved.

The LTC3856 monitors the output current by sensing the voltage drop across the output inductor (DCR) or by using a sense resistor. DCR temperature compensation maintains an accurate current sense threshold over a broad temperature range. A constant-frequency, current mode architecture allows a phase-lockable frequency of up to 770kHz.

A wide 4.5V to 38V input supply range encompasses most intermediate bus voltages and battery chemistries. Burst Mode operation, continuous or Stage Shedding modes are supported. A TK/SS pin shared by both channels ramps the output voltage during start-up.

LT, LTC, LTM, Linear Technology, the Linear logo, PolyPhase, Burst Mode and OPTI-LOOP are registered trademarks and Stage Shedding is a trademark of Linear Technology Corporation. All other trademarks are the property of their respective owners. Protected by U.S. Patents, including 5481178, 5705919, 5929620, 6100678, 6144194, 6177787, 6304066, 6498466, 6580258, 6611131, 6674274.

TYPICAL APPLICATION

High Efficiency 1.5V/50A Step-Down Converter

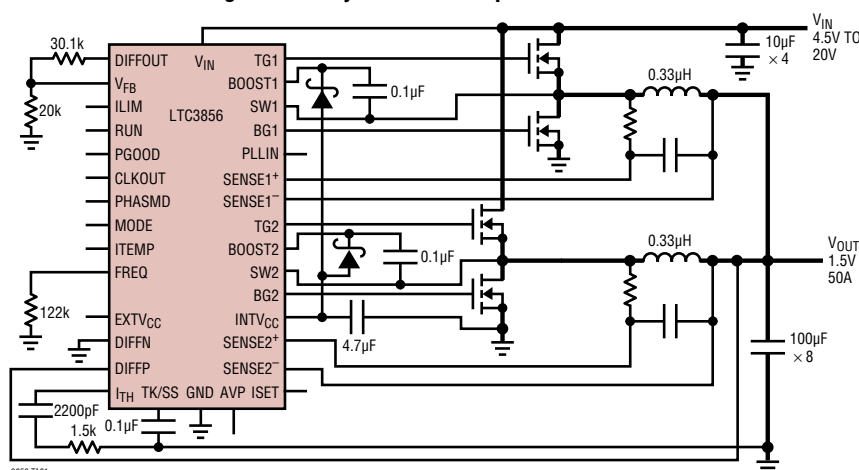

Efficiency and Power Loss vs Output Current

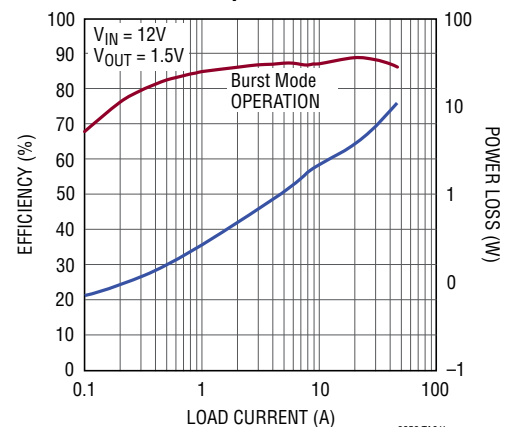

ABSOLUTE MAXIMUM RATINGS (Note 1)

Input Supply Voltage (V_{IN}) 40V to -0.3V
 Topside Driver Voltages ($BOOSTn$) 46V to -0.3V
 Switch Voltage (SWn) 40V to -5V
 $INTV_{CC}$, RUN, PGOOD, $EXTV_{CC}$,
 ($BOOSTn - SWn$) 6V to -0.3V
 $SENSEn$ Voltages 5.5V to -0.3V
 MODE, PLLIN, ILIM, TK/SS, AVP,
 FREQ, ISET Voltages $INTV_{CC}$ to -0.3V
 DIFFP, DIFFN, DIFFOUT, PHASMD,
 ITEMP Voltages $INTV_{CC}$ to -0.3V

I_{TH} , V_{FB} Voltages $INTV_{CC}$ to -0.3V
 $INTV_{CC}$ Peak Output Current 100mA
 Operating Junction Temperature Range
 (Notes 2, 3) -40°C to 125°C
 Storage Temperature Range -65°C to 125°C
 Reflow Peak Body Temperature (UH Package) 260°C
 Lead Temperature (Soldering, 10 sec.)
 FE Package 300°C

PIN CONFIGURATION

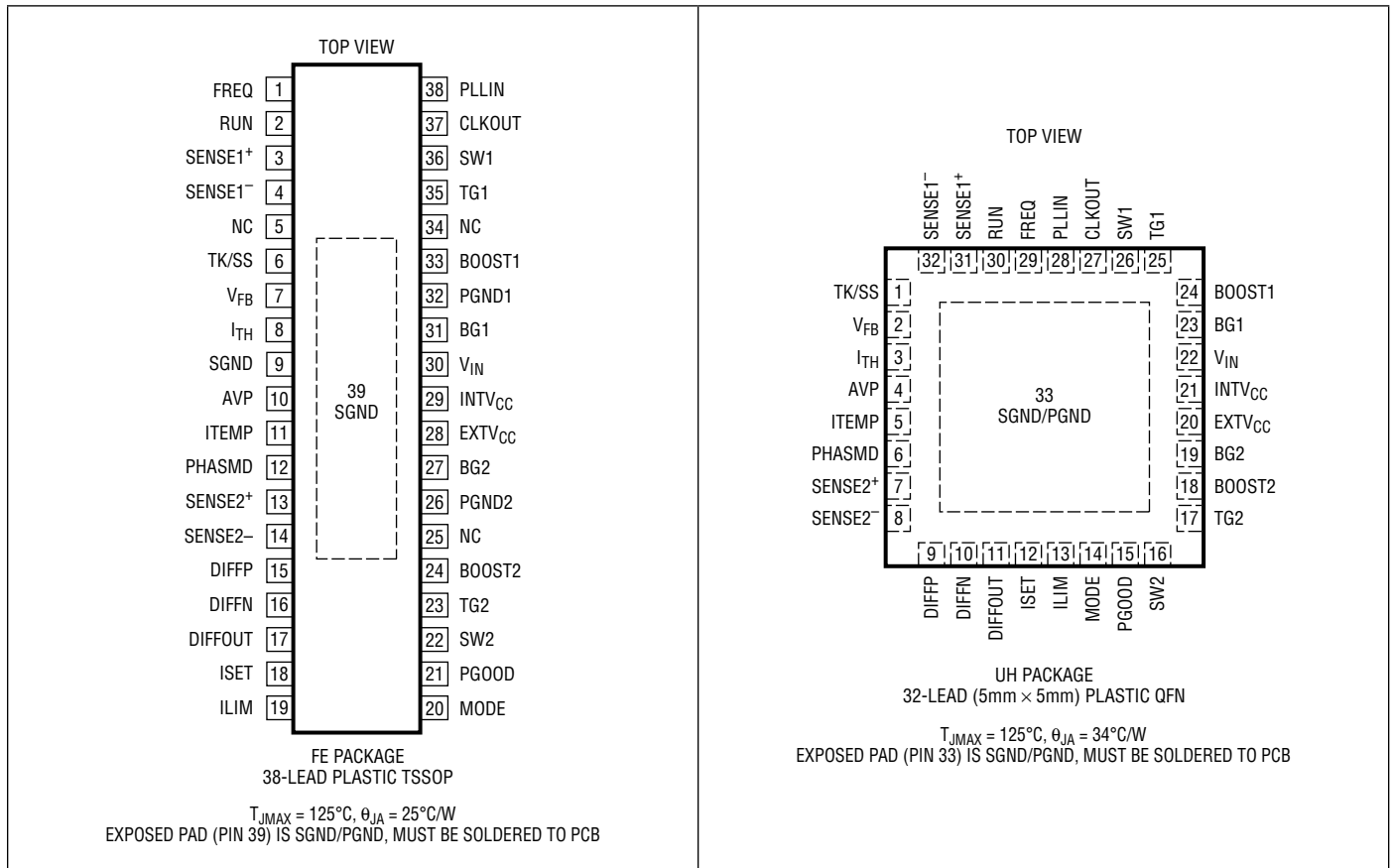

ORDER INFORMATION

LEAD FREE FINISH	TAPE AND REEL	PART MARKING*	PACKAGE DESCRIPTION	TEMPERATURE RANGE
LTC3856EFE#PBF	LTC3856EFE#TRPBF	LTC3856FE	38-Lead Plastic TSSOP	-40°C to 125°C
LTC3856IFE#PBF	LTC3856IFE#TRPBF	LTC3856FE	38-Lead Plastic TSSOP	-40°C to 125°C
LTC3856EUH#PBF	LTC3856EUH#TRPBF	3856	32-Lead (5mm × 5mm) Plastic QFN	-40°C to 125°C
LTC3856IUH#PBF	LTC3856IUH#TRPBF	3856	32-Lead (5mm × 5mm) Plastic QFN	-40°C to 125°C

Consult LTC Marketing for parts specified with wider operating temperature ranges. *The temperature grade is identified by a label on the shipping container. Consult LTC Marketing for information on non-standard lead based finish parts.

For more information on lead free part marking, go to: <http://www.linear.com/leadfree/>

For more information on tape and reel specifications, go to: <http://www.linear.com/tapeandree/>

ELECTRICAL CHARACTERISTICS

The ● denotes the specifications which apply over the full operating junction temperature range, otherwise specifications are at $T_A = 25^\circ\text{C}$ (Note 2). $V_{IN} = 15\text{V}$, $V_{RUN} = 5\text{V}$, unless otherwise noted.

SYMBOL	PARAMETER	CONDITIONS	MIN	TYP	MAX	UNITS	
Main Control Loops							
V_{IN}	Input Voltage		4.5		38	V	
V_{OUT}	Output Voltage		0.6		5.0	V	
V_{FB}	Regulated Feedback Voltage	I_{TH} Voltage = 1.2V, E-Grade (Note 4)	● 0.5955	0.600	0.6045	V	
		I_{TH} Voltage = 1.2V, I-Grade (Note 4)	● 0.593	0.600	0.607	V	
I_{FB}	Feedback Current	(Note 4)		-15	-50	nA	
$V_{REFLNREG}$	Reference Voltage Line Regulation	$V_{IN} = 4.5\text{V}$ to 38V (Note 4)		0.002	0.02	%/V	
$V_{LOADREG}$	Output Voltage Load Regulation	(Note 4) Measured in Servo Loop, ΔI_{TH} Voltage = 1.2V to 0.7V	●	0.01	0.1	%	
		Measured in Servo Loop, ΔI_{TH} Voltage = 1.2V to 1.6V	●	-0.01	-0.1	%	
g_m	Transconductance Amplifier g_m	$I_{TH} = 1.2\text{V}$, Sink/Source 5 μA (Note 4)		2.0		mmho	
I_Q	Input DC Supply Current	(Note 5)					
	Normal Mode	$V_{IN} = 15\text{V}$		4.0		mA	
	Shutdown	$V_{RUN} = 0\text{V}$		40	70	μA	
DF_{MAX}	Maximum Duty Factor	In Dropout; $f_{OSC} = 500\text{kHz}$		93	94	%	
UVLO	Undervoltage Lockout	V_{INTVCC} Ramping Down	●	3.0	3.2	3.4	V
UVLO Hyst	UVLO Hysteresis			0.6		V	
V_{OVL}	Feedback Overvoltage Lockout	Measured at V_{FB}	●	0.64	0.66	0.68	V
I_{SENSE+}	SENSE+ Pins Bias Current	Each Channel, $V_{SENSE1,2} = 3.3\text{V}$	●	±1	±2	μA	
I_{TEMP}	DCR Tempco Compensation Current	$V_{TEMP} = 0.3\text{V}$	●	9	10	11	μA
$I_{TK/SS}$	Soft-Start Charge Current	$V_{TK/SS} = 0\text{V}$	●	1.0	1.25	1.5	μA
V_{RUN}	RUN Pin On Threshold	V_{RUN} Rising	●	1.1	1.22	1.35	V
V_{RUNHYS}	RUN Pin On Hysteresis			80		mV	
$V_{SENSE(MAX)}$	Maximum Current Sense Threshold (E-Grade)	$V_{FB} = 0.5\text{V}$, $V_{SENSE1,2} = 3.3\text{V}$	●	25	30	35	mV
		$I_{LIM} = 0\text{V}$	●	45	50	55	mV
		$I_{LIM} = \text{Float}$	●	68	75	82	mV
		$I_{LIM} = \text{INTVCC}$					
$V_{SENSE(MAX)}$	Maximum Current Sense Threshold (I-Grade)	$V_{FB} = 0.5\text{V}$, $V_{SENSE1,2} = 3.3\text{V}$	●	23	30	37	mV
		$I_{LIM} = 0\text{V}$	●	43	50	57	mV
		$I_{LIM} = \text{Float}$	●	66	75	84	mV
		$I_{LIM} = \text{INTVCC}$					

ELECTRICAL CHARACTERISTICS

The ● denotes the specifications which apply over the full operating junction temperature range, otherwise specifications are at $T_A = 25^\circ\text{C}$ (Note 2). $V_{IN} = 15\text{V}$, $V_{RUN} = 5\text{V}$, unless otherwise noted.

SYMBOL	PARAMETER	CONDITIONS	MIN	TYP	MAX	UNITS
TG1,2 t_r TG1,2 t_f	TG Transition Time Rise Time Fall Time	(Note 6) $C_{LOAD} = 3300\text{pF}$ $C_{LOAD} = 3300\text{pF}$		25 25		ns ns
BG1,2 t_r BG1,2 t_f	BG Transition Time Rise Time Fall Time	(Note 6) $C_{LOAD} = 3300\text{pF}$ $C_{LOAD} = 3300\text{pF}$		25 25		ns ns
TG/BG t_{1D}	Top Gate Off to Bottom Gate On Delay Synchronous Switch-On Delay Time	$C_{LOAD} = 3300\text{pF}$ Each Driver		30		ns
BG/TG t_{2D}	Bottom Gate Off to Top Gate On Delay Top Switch-On Delay Time	$C_{LOAD} = 3300\text{pF}$ Each Driver		30		ns
$t_{ON(MIN)}$	Minimum On-Time	(Note 7)		90		ns
INTV_{CC} Linear Regulator						
V_{INTVCC}	Internal V_{CC} Voltage	$6\text{V} < V_{IN} \leq 38\text{V}$	4.8	5.0	5.2	V
$V_{LDO INT}$	INTV _{CC} Load Regulation	$I_{CC} = 0\text{mA}$ to 20mA		0.5	2.0	%
V_{EXTVCC}	EXTV _{CC} Switchover Voltage	EXTV _{CC} Ramping Positive ●	4.5	4.7		V
$V_{LDO EXT}$	EXTV _{CC} Voltage Drop	$I_{CC} = 20\text{mA}$, $V_{EXTVCC} = 5\text{V}$		50	100	mV
V_{LDOHYS}	EXTV _{CC} Hysteresis			200		mV
Oscillator and Phase-Locked Loop						
f_{NOM}	Nominal Frequency	$V_{FREQ} = 1.2\text{V}$	450	500	550	kHz
f_{LOW}	Lowest Frequency	$V_{FREQ} = 0\text{V}$	210	250	290	kHz
f_{HIGH}	Highest Frequency	$V_{FREQ} \geq 2.4\text{V}$	700	770	850	kHz
R_{MODE}	MODE Input Resistance			250		k Ω
I_{FREQ}	Frequency Setting Output Current		9	10	11	μA
CLKOUT	Phase (Relative to Controller 1)	PHASMD = GND; Non Stage Shedding Mode PHASMD = FLOAT; Non Stage Shedding Mode PHASMD = INTV _{CC} ; Non Stage Shedding Mode Stage Shedding Mode		60 90 120 180		Deg Deg Deg Deg
CLKHIGH	Clock High Output Voltage		4	5		V
CLKLOW	Clock Low Output Voltage			0	0.2	V
PGOOD Output						
V_{PGL}	PGOOD Voltage Low	$I_{PGOOD} = 2\text{mA}$		0.1	0.2	V
I_{PGOOD}	PGOOD Leakage Current	$V_{PGOOD} = 5\text{V}$			± 2	μA
V_{PG}	PGOOD Trip Level, Either Controller	V_{FB} with Respect to Set Output Voltage V_{FB} Ramping Negative V_{FB} Ramping Positive		-10 10		% %

ELECTRICAL CHARACTERISTICS

The ● denotes the specifications which apply over the full operating junction temperature range, otherwise specifications are at $T_A = 25^\circ\text{C}$ (Note 2). $V_{IN} = 15\text{V}$, $V_{RUN} = 5\text{V}$, unless otherwise noted.

SYMBOL	PARAMETER	CONDITIONS	MIN	TYP	MAX	UNITS
Differential Amplifier						
A_{DA}	Gain	E-Grade	● 0.998	1	1.002	V/V
		I-Grade	● 0.997	1	1.003	V/V
R_{IN}	Input Resistance	Measured at DIFFP Input		80		k Ω
V_{OS}	Input Offset Voltage	$V_{DIFFP} = V_{DIFFOUT} = 1.5\text{V}$, $I_{DIFFOUT} = 100\mu\text{A}$			2	mV
PSRR	Power Supply Rejection Ratio	$4.5\text{V} < V_{IN} < 38\text{V}$		100		dB
I_{CL}	Maximum Output Current		2	3		mA
$V_{OUT(MAX)}$	Maximum Output Voltage	$I_{DIFFOUT} = 300\mu\text{A}$	$V_{INTVCC} - 1.4$	$V_{INTVCC} - 1.1$		V
On-Chip Driver						
TG R_{UP}	TG Pull-Up $R_{DS(ON)}$	TG High		2.6		Ω
TG R_{DOWN}	TG Pull-Down $R_{DS(ON)}$	TG Low		1.5		Ω
BG R_{UP}	BG Pull-Up $R_{DS(ON)}$	BG High		2.4		Ω
BG R_{DOWN}	BG Pull-Down $R_{DS(ON)}$	BG Low		1.1		Ω
GBW	Gain-Bandwidth Product	(Note 8)		3		MHz
SR	Slew Rate	(Note 8)		2		V/ μs
Stage Shedding Mode						
I_{ISET}	Programmable Stage Shedding Mode Current		6.5	7.5	8.5	μA
AVP (Active Voltage Positioning)						
V_{AVP}	Maximum V_{OUT} with AVP			2.5		V
I_{SINK}	Sink Current of AVP Pin	SENSE ⁺ = 1.2V		250		μA
I_{SOURCE}	Source Current of AVP Pin	SENSE ⁺ = 1.2V		2		mA
$V_{AVP-V_O(MAX)}$	Maximum Voltage Drop V_{AVP} to V_O	SENSE ⁺ = 1.2V		120		mV

Note 1: Stresses beyond those listed under Absolute Maximum Ratings may cause permanent damage to the device. Exposure to any Absolute Maximum Rating condition for extended periods may affect device reliability and lifetime.

Note 2: The LTC3856 is tested under pulse load conditions such that $T_J \approx T_A$. The LTC3856E is guaranteed to meet performance specifications from 0°C to 85°C operating junction temperature. Specifications over the -40°C to 125°C operating junction temperature range are assured by design, characterization and correlation with statistical process controls. The LTC3856I is guaranteed to meet performance specifications over the full -40°C to 125°C operating junction temperature range.

Note 3: T_J is calculated from the ambient temperature, T_A , and power dissipation, P_D , according to the following formula:

$$\text{LTC3856UH: } T_J = T_A + (P_D \cdot 34^\circ\text{C/W})$$

$$\text{LTC3856FE: } T_J = T_A + (P_D \cdot 25^\circ\text{C/W})$$

Note 4: The LTC3856 is tested in a feedback loop that servos V_{ITH} to a specified voltage and measures the resultant V_{FB} .

Note 5: Dynamic supply current is higher due to the gate charge being delivered at the switching frequency. See the Applications Information section.

Note 6: Rise and fall times are measured using 10% and 90% levels. Delay times are measured using 50% levels.

Note 7: The minimum on-time condition corresponds to the on inductor peak-to-peak ripple current $\geq 40\%$ of I_{MAX} (see Minimum On-Time Considerations in the Applications Information section).

Note 8: Guaranteed by design.

TYPICAL PERFORMANCE CHARACTERISTICS

**Load Step:
Burst Mode Operation**

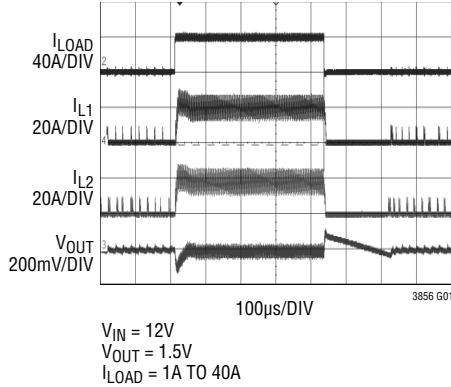

**Load Step:
Forced Continuous Mode**

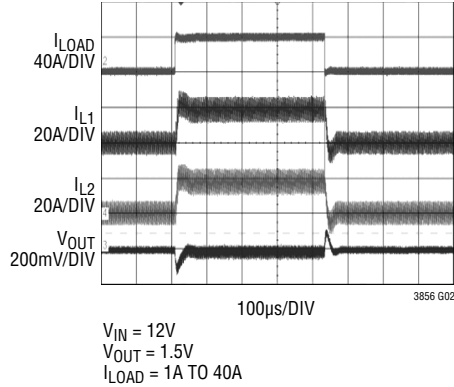

**Efficiency vs Output Current
and Mode**

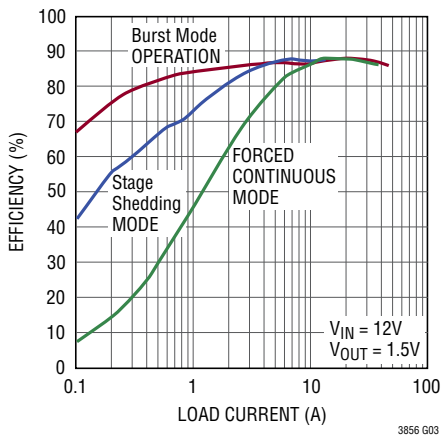

Inductor Current at Light Load

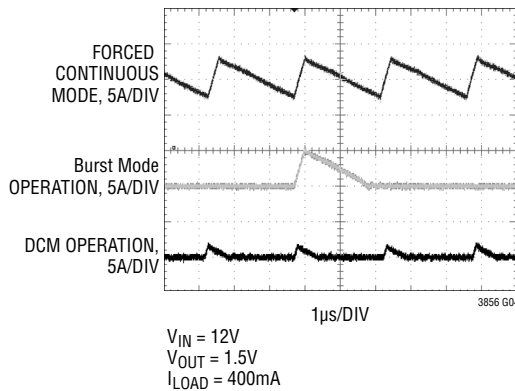

**Stage Shedding Transition,
1-Phase to 2-Phase**

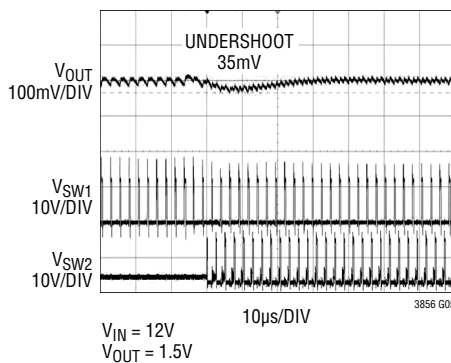

**Stage Shedding Transition,
2-Phase to 1-Phase**

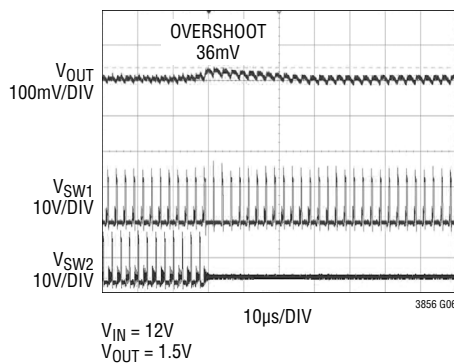

TYPICAL PERFORMANCE CHARACTERISTICS

Load Step without AVP

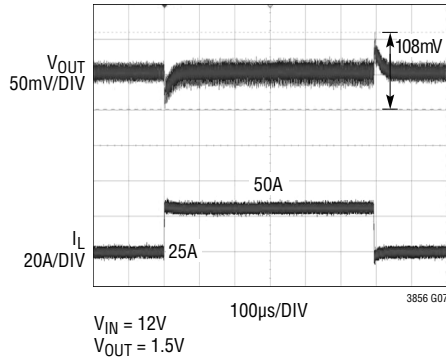

Load Step with AVP

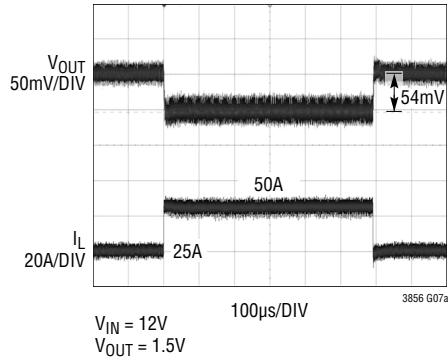

Quiescent Current vs Input Voltage without EXT_{VCC}

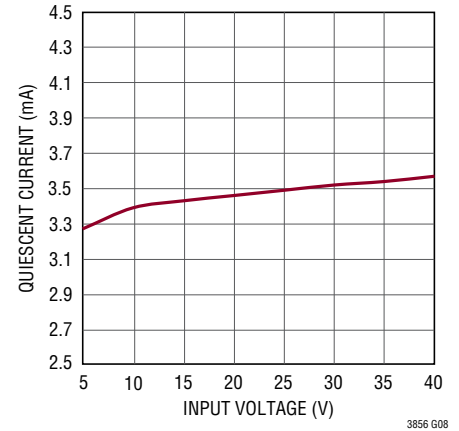

INT_{VCC} Line Regulation

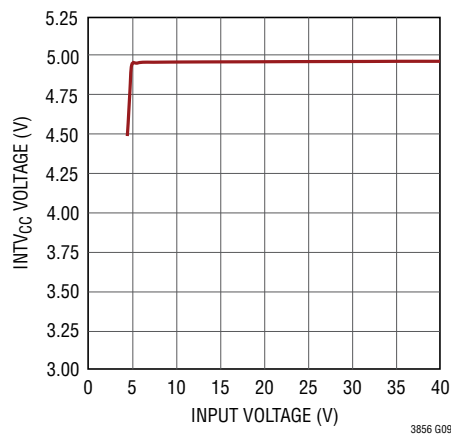

Current Sense Threshold vs I_{TH} Voltage

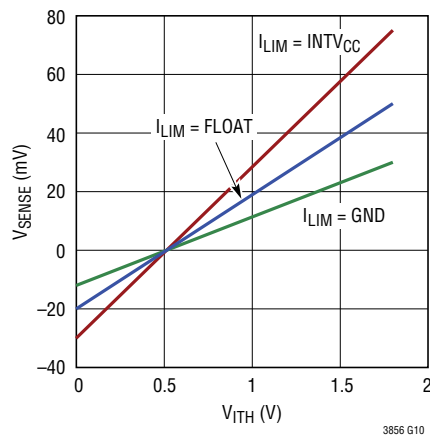

Maximum Current Sense Threshold vs Common Mode Voltage

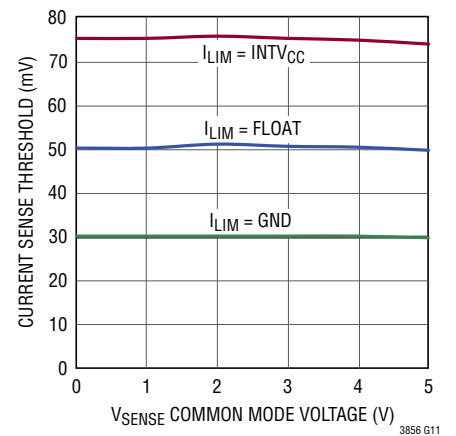

Maximum Current Sense Voltage vs Duty Cycle

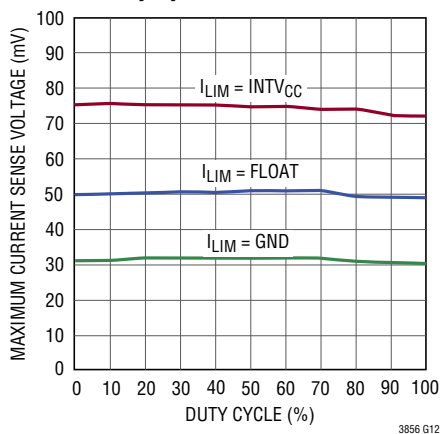

Maximum Current Sense Voltage vs Feedback Voltage (Current Foldback)

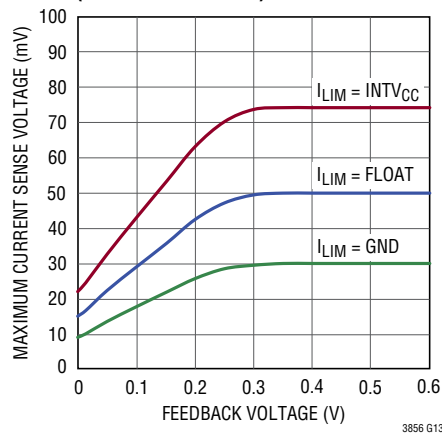

TK/SS Pull-Up Current vs Temperature

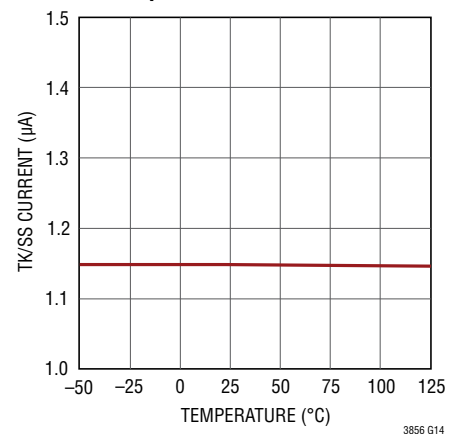

TYPICAL PERFORMANCE CHARACTERISTICS

Shutdown (RUN) Threshold vs Temperature

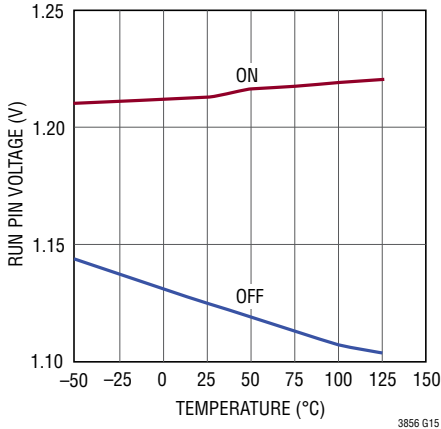

Regulated Feedback Voltage vs Temperature

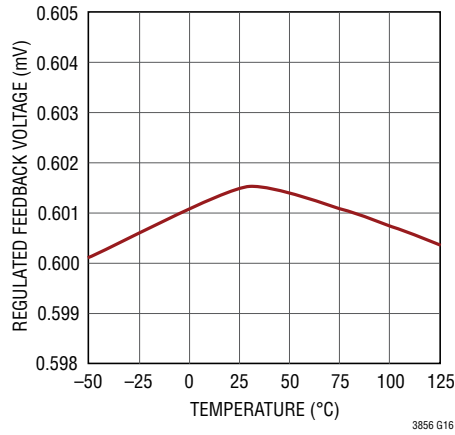

Oscillator Frequency vs Temperature

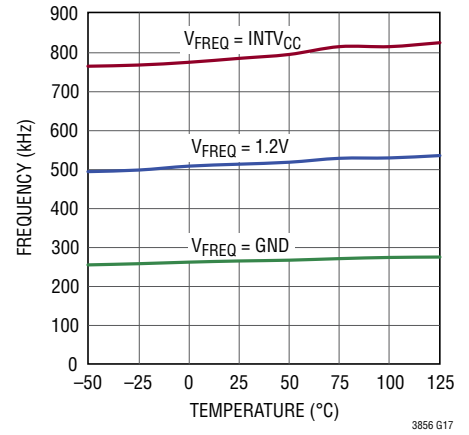

Undervoltage Lockout Threshold (INTV_{CC}) vs Temperature

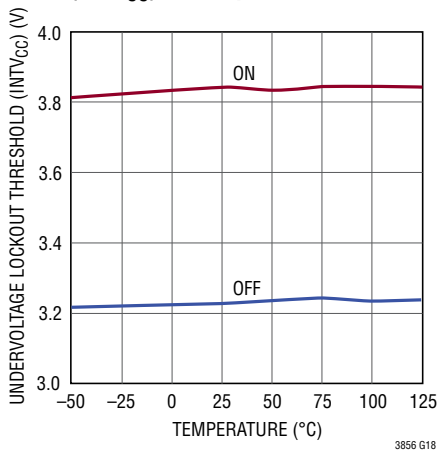

Oscillator Frequency vs Input Voltage

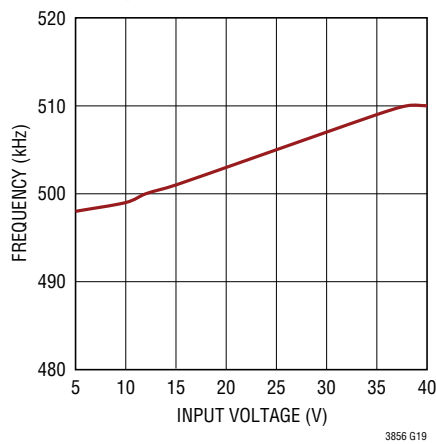

Shutdown Current vs Input Voltage

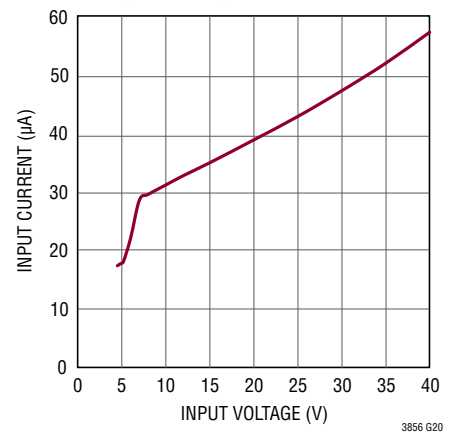

Shutdown Current vs Temperature

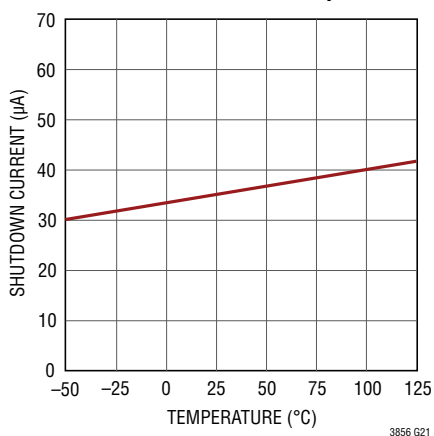

Quiescent Current vs Temperature without EXT_VCC

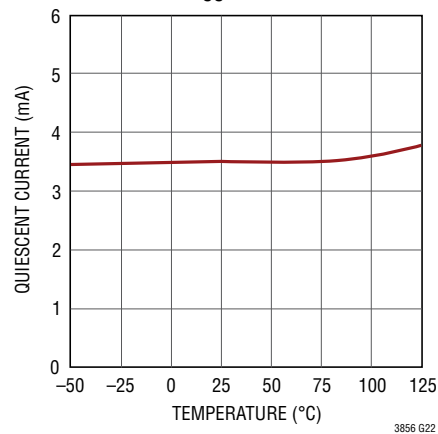

PIN FUNCTIONS (TSSOP/QFN)

FREQ (Pin 1/Pin 29): Frequency Setting Pin. A resistor to ground sets the operating frequency of the controller. This pin can also be driven with a DC voltage to vary the frequency of the internal oscillator.

RUN (Pin 2/Pin 30): Run Control Input. A voltage above 1.22V on this pin turns on the IC. There is a 1 μ A pull-up current for this pin. Once the RUN pin rises above 1.22V, an additional 4.5 μ A pull-up current is added to the pin.

SENSE1⁺, SENSE2⁺ (Pins 3, 13/Pins 31, 7): Current Sense Comparator Inputs. The (+) inputs to the current comparators are normally connected to DCR sensing networks or current sensing resistors.

SENSE1⁻, SENSE2⁻ (Pins 4, 14/Pins 32, 8): Current Sense Comparator Inputs. The (-) inputs to the current comparators are connected to the outputs.

NC (Pins 5, 25, 34) TSSOP Package: No Connections.

TK/SS (Pin 6/Pin 1): Output Voltage Tracking and Soft-Start Input. When one particular IC is configured to be the master of two ICs, a capacitor to ground at this pin sets the ramp rate for the master IC's output voltage. When the IC is configured to be the slave of two ICs, the V_{FB} voltage of the master IC is reproduced by a resistor divider and applied to this pin. An internal soft-start current of 1.25 μ A is charging this pin.

V_{FB} (Pin 7/Pin 2): Error Amplifier Feedback Input. This pin receives the remotely sensed feedback voltage from an external resistive divider.

I_{TH} (Pin 8/Pin 3): Current Control Threshold and Error Amplifier Compensation Point. Each associated channels' current comparator tripping threshold increases with I_{TH} control voltage.

SGND (Pin 9/Pin 33): Signal Ground and Power Ground. All small-signal components and compensation components should connect to this ground, which in turn connects to PGND at one point.

AVP (Pin 10/Pin 4): Active Voltage Positioning Load Slope Programming Pin. A resistor between this pin and the DIFFP pin sets the load slope. The AVP function can only be used with the remote sensing differential amplifier.

Float or connect a 1k resistor to DIFFP pin when AVP function is not used.

ITEMP (Pin 11/Pin 5): Input to the Temperature Sensing Circuit. Connect this pin to an external NTC (negative temperature coefficient) resistor placed near the heat source on the PCB board (e.g., inductors) changes the controller's current limit with temperature.

PHASMD (Pin 12/Pin 6): Connect this pin to SGND, INTV_{CC}, or float this pin to select the phase of CLKOUT to be 60°, 120° and 90°, respectively.

DIFFP (Pin 15/Pin 9): Positive Input of Remote Sensing Differential Amplifier. Must connect this pin directly to the remote load voltage or local V_{OUT} even when AVP or diffamp is not used.

DIFFN (Pin 16/Pin 10): Negative Input of Remote Sensing Differential Amplifier. Connect this pin to the negative terminal of output load capacitors.

DIFFOUT (Pin 17/Pin 11): Output of Remote Sensing Differential Amplifier. Connect this pin to V_{FB} through a resistive divider.

ISSET (Pin 18/Pin 12): Stage Shedding Mode Comparator and Burst Mode Comparator Programming Pin. A resistor to ground programs the threshold of the Stage Shedding mode comparator or Burst Mode comparator threshold and current limit.

I_{LIM} (Pin 19/Pin 13): Current Comparator Sense Voltage Range Input. This pin is to be programmed to SGND, FLOAT or INTV_{CC} to set the maximum current sense threshold to one of three different levels for both comparators.

MODE (Pin 20/Pin 14): Forced Continuous Mode, Burst Mode Operation or Stage Shedding Mode Selection Pin. Connect this pin to SGND to force IC in continuous mode of operation. Connect to INTV_{CC} to enable Stage Shedding mode operation. Leaving the pin floating enables Burst Mode operation.

PGOOD (Pin 21/Pin 15): Power Good Indicator Output. Open-drain logic out that is pulled to ground when the output exceeds the $\pm 10\%$ regulation window, after the internal 20 μ s power-bad mask timer expires.

PIN FUNCTIONS (TSSOP/QFN)

EXTV_{CC} (Pin 28/Pin 20): External Power Input to an Internal Switch Connected to INTV_{CC}. This switch closes and supplies the IC power, bypassing the internal low dropout regulator, whenever EXTV_{CC} is higher than 4.7V. Do not exceed 6V on this pin and ensure $V_{IN} > V_{EXTVCC}$ at all times.

INTV_{CC} (Pin 29/Pin 21): Internal 5V Regulator Output. The control circuits are powered from this voltage. Decouple this pin to PGND with a minimum of 4.7 μ F low ESR tantalum or ceramic capacitor.

V_{IN} (Pin 30/Pin 22): Main Input Supply. Decouple this pin to PGND with a capacitor (0.1 μ F to 1 μ F).

BG1, BG2 (Pins 31, 27/Pins 23, 19): Bottom Gate Driver Outputs. These pins drive the gates of the bottom N-channel MOSFETs between INTV_{CC} and PGND.

PGND1, PGND2 (Pins 32, 26) TSSOP Package: Power Ground Pin. Connect this pin closely to the sources of the bottom N-channel MOSFETs, the (–) terminal of CV_{CC} and the (–) terminal of C_{IN}.

BOOST1, BOOST2 (Pins 33, 24/Pins 24, 18): Boosted Floating Driver Supplies. The (+) terminal of the bootstrap capacitors connect to these pins. These pins swing from a diode voltage drop below INTV_{CC} up to $V_{IN} + INTV_{CC}$.

SGND/PGND (Exposed Pad Pin 33) QFN Package: Signal Ground and Power Ground. Connect this pin closely to

the sources of the bottom N-channel MOSFETs, the (–) terminal of CV_{CC} and the (–) terminal of C_{IN}. All small-signal components and compensation components should also connect to this ground.

TG1, TG2 (Pins 35, 23/Pins 25, 17): Top Gate Driver Outputs. These are the outputs of floating drivers with a voltage swing equal to INTV_{CC} superimposed on the switch nodes voltages.

SW1, SW2 (Pins 36, 22/Pins 26, 16): Switch Node Connections to Inductors. Voltage swing at these pins is from a Schottky diode (external) voltage drop below ground to V_{IN}.

CLKOUT (Pin 37/Pin 27): Clock output with phase changeable by PHASMD to enable usage of multiple LTC3856 ICs in multiphase systems.

PLLIN (Pin 38/Pin 28): External Synchronization Pin. A clock on the pin synchronizes the internal oscillator with the clock on this pin.

SGND (Exposed Pad Pin 39) TSSOP Package: The exposed pad must be soldered to PCB ground for electrical connection and rated thermal performance.

FUNCTIONAL DIAGRAM

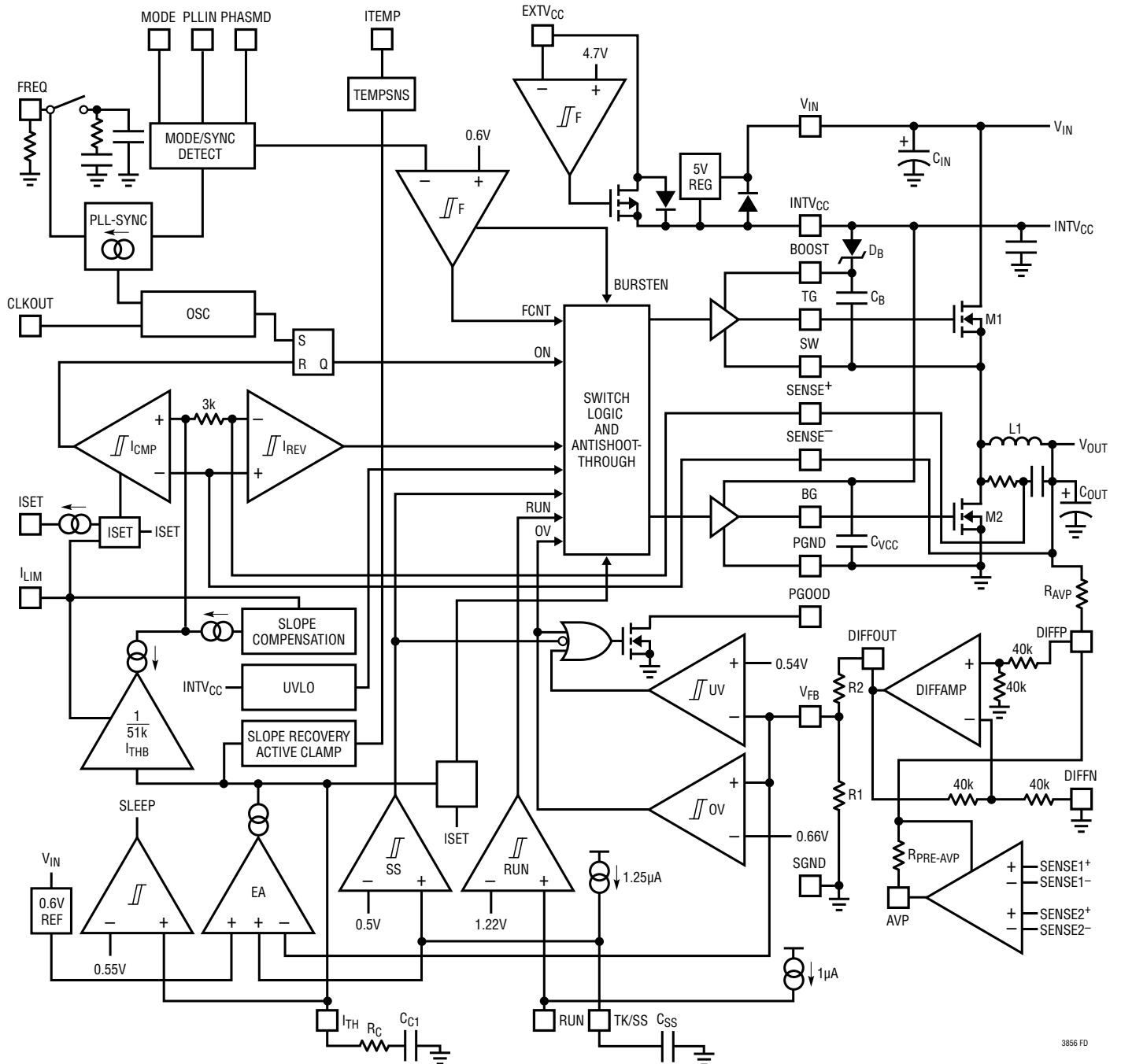

3856 FD

OPERATION (Refer to Functional Diagram)

Main Control Loop

The LTC3856 uses a constant-frequency, current mode step-down architecture. During normal operation, each top MOSFET is turned on each cycle when the oscillator sets the RS latch, and turned off when the main current comparator, I_{CMP} , resets each RS latch. The peak inductor current at which I_{CMP} resets the RS latch is controlled by the voltage on the I_{TH} pin, which is the output of the error amplifier, EA. The V_{FB} pin receives a portion of output voltage feedback signal via the DIFFOUT pin (if DIFFAMP is used) through the external resistive divider and is compared to the internal reference voltage. When the load current increases, it causes a slight decrease in the V_{FB} pin voltage relative to the 0.6V reference, which in turn causes the I_{TH} voltage to increase until each inductor's average current matches half of the new load current (assuming the two current sensing resistors are equal). In Burst Mode operation, after each top MOSFET has turned off, the bottom MOSFET is turned on until either the inductor current starts to reverse, as indicated by the reverse current comparator, I_{REV} , or the beginning of the next cycle.

The main control loop is shut down by pulling the RUN pin low. Releasing RUN allows an internal $1\mu\text{A}$ current source to pull up the RUN pin. When the RUN pin reaches 1.22V, the main control loop is enabled and the IC is powered up. When the RUN pin is low, all functions are kept in a controlled state.

INTV_{CC}/EXTV_{CC} Power

Power for the top and bottom MOSFET drivers and most other internal circuitry is derived from the INTV_{CC} pin. When the EXTV_{CC} pin is left open or tied to a voltage less than 4.7V, an internal 5V linear regulator supplies INTV_{CC} power from V_{IN} . If EXTV_{CC} is taken above 4.7V, the 5V regulator is turned off and an internal switch is turned on connecting EXTV_{CC}. Using the EXTV_{CC} pin allows the INTV_{CC} power to be derived from a high efficiency external source such as a switching regulator output. Each top MOSFET driver is biased from the floating bootstrap capacitor, C_B ,

which normally recharges during each off cycle through an external diode when the top MOSFET turns off. If the input voltage, V_{IN} , decreases to a voltage close to V_{OUT} , the loop may enter dropout and attempt to turn on the top MOSFET continuously. The dropout detector detects this and forces the top MOSFET off for about one-twelfth of the clock period plus 100ns every third cycle to allow C_B to recharge. However, it is recommended that a load be present or the IC operates at low frequency during the dropout transition to ensure C_B is recharged.

Shutdown and Start-Up (RUN and TK/SS Pins)

The LTC3856 can be shut down using the RUN pin. Pulling the RUN pin below 1.22V shuts down the main control loop for the controller and most internal circuits, including the INTV_{CC} regulator. Releasing the RUN pin allows an internal $1\mu\text{A}$ current to pull up the pin and enable the controller. Alternatively, the RUN pin may be externally pulled up or driven directly by logic. Be careful not to exceed the absolute maximum rating of 6V on this pin. The start-up of the controller's output voltage, V_{OUT} , is controlled by the voltage on the TK/SS pin. When the voltage on the TK/SS pin is less than the 0.6V internal reference, the LTC3856 regulates the V_{FB} voltage to the TK/SS pin voltage instead of the 0.6V reference. This allows the TK/SS pin to be used to program a soft-start by connecting an external capacitor from the TK/SS pin to SGND. An internal $1.25\mu\text{A}$ pull-up current charges this capacitor, creating a voltage ramp on the TK/SS pin. As the TK/SS voltage rises linearly from 0V to 0.6V (and beyond), the output voltage, V_{OUT} , rises smoothly from zero to its final value. Alternatively, the TK/SS pin can be used to cause the start-up of V_{OUT} to track that of another supply. Typically, this requires connecting to the TK/SS pin an external resistor divider from the other supply to ground (see the Applications Information section). When the RUN pin is pulled low to disable the controller, or when INTV_{CC} drops below its undervoltage lockout threshold of 3.2V, the TK/SS pin is pulled low by an internal MOSFET. When in undervoltage lockout, all phases of the controller are disabled and the external MOSFETs are held off.

OPERATION (Refer to Functional Diagram)

Light Load Current Operation (Burst Mode Operation, Stage Shedding or Continuous Conduction)

The LTC3856 can be enabled to enter high efficiency Burst Mode operation, Stage Shedding mode or forced continuous conduction mode. To select forced continuous operation, tie the MODE pin to a DC voltage below 0.6V (e.g., SGND). To select Stage Shedding mode of operation, tie the MODE pin to INTV_{CC}. To select Burst Mode operation, float the MODE pin.

When the controller is enabled for Burst Mode operation, the peak current in the inductor is set to approximately one-sixth of the maximum sense voltage even though the voltage on the I_{TH} pin indicates a lower value. The peak current can be programmed by the ISET pin. If the average inductor current is higher than the load current, the error amplifier, EA, will decrease the voltage on the I_{TH} pin. When the I_{TH} voltage drops, the internal sleep signal goes high (enabling sleep mode) and the external MOSFETs are turned off. In sleep mode, the load current is supplied by the output capacitor. As the output voltage decreases, the EA's output begins to rise. When the output voltage drops enough, the sleep signal goes low, and the controller resumes normal operation by turning on the top external MOSFET on the next cycle of the internal oscillator. When a controller is enabled for Burst Mode operation, the inductor current is not allowed to reverse. The reverse current comparator, I_{REV}, turns off the bottom external MOSFET just before the inductor current reaches zero, preventing it from reversing and going negative. Thus, the controller operates in discontinuous operation. In forced continuous operation, the inductor current is allowed to reverse at light loads or under large transient conditions. The peak inductor current is determined by the voltage on the I_{TH} pin, just as in normal operation. In this mode, the efficiency at light loads is lower than in Burst Mode operation. However, continuous mode has the advantages of lower output ripple and less interference with audio circuitry.

When the MODE pin is connected to INTV_{CC}, the LTC3856 operates in Stage Shedding mode at light loads. The controller will turn off channel 2 and increase the current gain of the first channel to ensure a smooth transition. The

threshold where the controller goes into Stage Shedding mode is where the I_{TH} voltage drops below 0.5V, but it can be programmed by the ISET pin. The inductor current is not allowed to reverse in this mode (discontinuous operation). At very light loads, the current comparator may remain tripped for several cycles and force the external top MOSFET to stay off for the same number of cycles (i.e., skipping pulses). This mode exhibits low output ripple as well as low audio noise and reduced RF interference as compared to Burst Mode operation. It provides a higher low current efficiency than forced continuous mode, but not nearly as high as Burst Mode operation.

Multichip Operations (PHASMD and CLKOUT Pins)

The LTC3856's two channels are 180° out-of-phase, providing multiphase operation. This configuration can provide enough power for most of the high current applications. However, for even higher power applications, the LTC3856 can be configured for PolyPhase and multichip operation. The LTC3856 features PHASMD and CLKOUT pins which enable multiple LTC3856s to operate out-of-phase, as shown in Table 1. The CLKOUT signal is out-of-phase with respect to phase 1 of the controller depending on the PHASMD pin setting. In Stage Shedding mode, however, the CLKOUT signal is 180° out-of-phase with respect to phase 1 of the controller.

Table 1.

PHASMD	GND	FLOAT	INTV _{CC}
Phase 1	0°	0°	0°
Phase 2	180°	180°	240°
CLKOUT	60°	90°	120°

Frequency Selection and Phase-Locked Loop (FREQ and PLLIN Pins)

The selection of switching frequency is a trade-off between efficiency and component size. Low frequency operation increases efficiency by reducing MOSFET switching losses, but requires larger inductance and/or capacitance to maintain low output ripple voltage.

If the PLLIN pin is not being driven by an external clock source, the FREQ pin can be used to program the control-

OPERATION (Refer to Functional Diagram)

ler's operating frequency from 250kHz to 770kHz. There is a precision 10 μ A current flowing out of the FREQ pin enabling the user to program the controller's switching frequency with a single resistor to SGND. A curve is provided later in the Applications Information section showing the relationship between the voltage on the FREQ pin and switching frequency.

A phase-locked loop (PLL) is available on the LTC3856 to synchronize the internal oscillator to an external clock source that is connected to the PLLIN pin. The PLL loop filter network is integrated inside the LTC3856. The phase-locked loop is capable of locking any frequency within the range of 250kHz to 770kHz. The frequency setting resistor should always be present to set the controller's initial switching frequency before locking to the external clock.

Sensing the Output Voltage with a Differential Amplifier

The LTC3856 includes a low offset, unity-gain, high bandwidth differential amplifier for applications that require true remote sensing. Sensing the load across the load capacitors directly greatly benefits regulation in high current, low voltage applications, where board interconnection losses can be a significant portion of the total error budget.

The LTC3856 differential amplifier has a typical output slew rate of 2V/ μ s. The amplifier is configured for unity gain, meaning that the difference between DIFFP and DIFFN is translated to DIFFOUT, relative to SGND.

Care should be taken to route the DIFFP and DIFFN PCB traces parallel to each other all the way to the terminals of the output capacitor or remote sensing points on the board. In addition, avoid routing these sensitive traces near any high speed switching nodes in the circuit. Ideally, the DIFFP and DIFFN traces should be shielded by a low impedance ground plane to maintain signal integrity.

The maximum output voltage when using the differential amplifier is $INTV_{CC} - 1.4V$ (typically 3.6V). The differential amplifier should not be used above this voltage.

Power Good (PGOOD Pin)

The PGOOD pin is connected to an open drain of an internal N-channel MOSFET. The MOSFET turns on and pulls the PGOOD pin low when either V_{FB} pin voltage is not within $\pm 10\%$ of the 0.6V reference voltage. The PGOOD pin is also pulled low when the RUN pin is below 1.22V or when the LTC3856 is in the soft-start or tracking phase. When the V_{FB} pin voltage is within the $\pm 10\%$ regulation window, the MOSFET is turned off and the pin is allowed to be pulled up by an external resistor to a source of up to 6V. The PGOOD pin will flag power good immediately when V_{FB} is within the regulation window. However, there is an internal 20 μ s power-bad mask when V_{FB} goes out of the regulation window.

Output Overvoltage Protection

An overvoltage comparator, OV, guards against transient overshoots ($>10\%$) as well as other more serious conditions that may overvoltage the output. In such cases, the top MOSFET is turned off and the bottom MOSFET is turned on until the overvoltage condition is cleared.

Undervoltage Lockout

The LTC3856 has two functions that help protect the controller in case of undervoltage conditions. A precision UVLO comparator constantly monitors the $INTV_{CC}$ voltage to ensure that an adequate gate-drive voltage is present. It locks out the switching action when $INTV_{CC}$ is below 3.2V. To prevent oscillation when there is a disturbance on the $INTV_{CC}$, the UVLO comparator has 600mV of precision hysteresis.

Another way to detect an undervoltage condition is to monitor the V_{IN} supply. Because the RUN pin has a precision turn-on reference of 1.22V, one can use a resistor divider to V_{IN} to turn on the IC when V_{IN} is high enough. An extra 4.5 μ A of current flows out of the RUN pin once the RUN pin voltage passes 1.22V. The RUN comparator itself has about 80mV of hysteresis. One can program additional hysteresis for the RUN comparator by adjusting the values of the resistive divider. For accurate V_{IN} undervoltage detection, V_{IN} needs to be higher than 4.5V.

APPLICATIONS INFORMATION

The Typical Application on the first page of this data sheet is a basic LTC3856 application circuit. LTC3856 can be configured to use either DCR (inductor resistance) sensing or low value resistor sensing. The choice between the two current sensing schemes is largely a design trade-off between cost, power consumption and accuracy. DCR sensing is becoming popular because it saves expensive current sensing resistors and is more power efficient, especially in high current applications. However, current sensing resistors provide the most accurate current limits for the controller. Other external component selection is driven by the load requirement, and begins with the selection of R_{SENSE} (if R_{SENSE} is used) and inductor value. Next, the power MOSFETs are selected. Finally, input and output capacitors are selected.

Current Limit Programming

The I_{LIM} pin is a tri-level logic input which sets the maximum current limit of the controller. When I_{LIM} is either grounded, floated or tied to $INTV_{CC}$, the typical value for the maximum current sense threshold will be 30mV, 50mV or 75mV, respectively.

Which setting should be used? For the best current limit accuracy, use the 75mV setting. The 30mV setting will allow for the use of very low DCR inductors or sense resistors, but at the expense of current limit accuracy. The 50mV setting is a good balance between the two.

SENSE+ and SENSE- Pins

The SENSE+ and SENSE- pins are the inputs to the current comparators. The common mode input voltage range of the current comparators is 0V to 5V. All SENSE+ pins are high impedance inputs with small currents of less than $1\mu A$. The positive high impedance input to the current comparators allows accurate DCR sensing. All SENSE- pins and DIFFP should be connected directly to V_{OUT} when DCR sensing is used. Care must be taken not to float these pins during normal operation. Filter components mutual to the sense lines should be placed close to the LTC3856, and the sense lines should run close together to a Kelvin connection underneath the current sense element (shown in Figure 1). Sensing current elsewhere can effectively add parasitic inductance and capacitance to the current sense element, degrading the information at the sense terminals and making the programmed current limit unpredictable. If DCR sensing is used (Figure 2b), sense resistor R1 should be placed close to the switching node, to prevent noise from coupling into sensitive small-signal nodes. The capacitor C1 should be placed close to the IC pins.

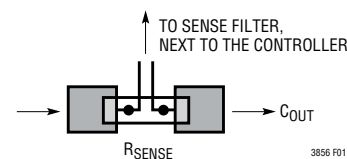
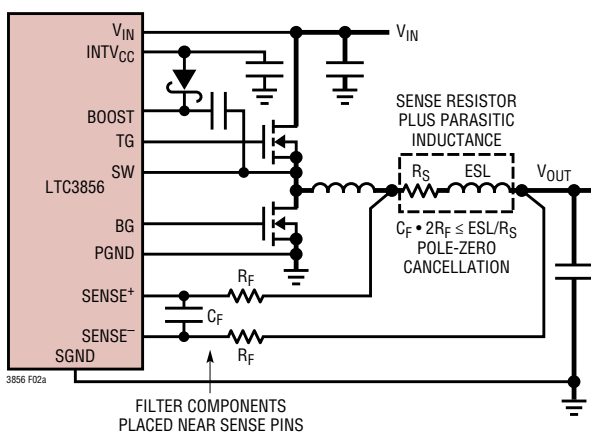
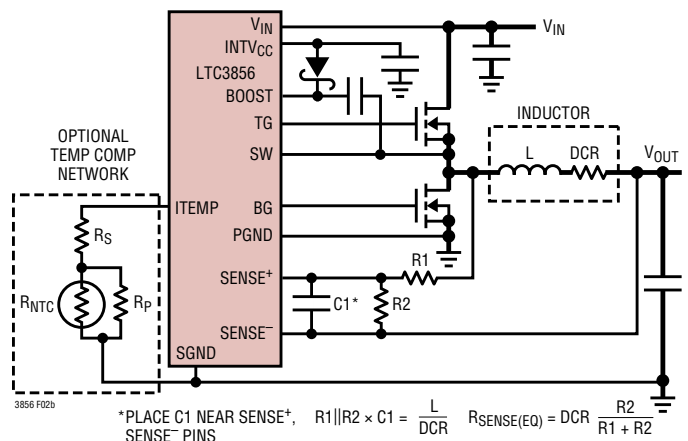

Figure 1. Sense Lines Placement with Sense Resistor



(2a) Using a Resistor to Sense Current



(2b) Using the Inductor DCR to Sense Current

Figure 2. Two Different Methods of Sensing Current

3856fa

APPLICATIONS INFORMATION

Low Value Resistors Current Sensing

A typical sensing circuit using a discrete resistor is shown in Figure 2a. R_{SENSE} is chosen based on the required output current. The current comparator has a maximum threshold, $V_{SENSE(MAX)}$, determined by the I_{LIM} setting. The input common mode range of the current comparator is 0V to 5V. The current comparator threshold sets the peak of the inductor current, yielding a maximum average output current, I_{MAX} , equal to the peak value less half the peak-to-peak ripple current, ΔI_L . To calculate the sense resistor value, use the equation:

$$R_{SENSE} = \frac{V_{SENSE(MAX)}}{I_{(MAX)} + \frac{\Delta I_L}{2}}$$

Because of possible PCB noise in the current sensing loop, the AC current sensing ripple of $\Delta V_{SENSE} = \Delta I_L \cdot R_{SENSE}$ also needs to be checked in the design to get a good signal-to-noise ratio. In general, for a reasonably good PCB layout, a 10mV ΔV_{SENSE} voltage is recommended as a conservative number to start with, either for R_{SENSE} or DCR sensing applications. For previous generation current mode controllers, the maximum sense voltage was high enough (e.g., 75mV for the LTC1628/LTC3728 family) that the voltage drop across the parasitic inductance of the sense resistor represented a relatively small error. For today's highest current density solutions, however, the value of the sense resistor can be less than 1m Ω and the peak sense voltage can be as low as 20mV. In addition, inductor ripple currents greater than 50%

with operation up to 1MHz are becoming more common. Under these conditions the voltage drop across the sense resistor's parasitic inductance is no longer negligible. A typical sensing circuit using a discrete resistor is shown in Figure 2a. In previous generations of controllers, a small RC filter placed near the IC was commonly used to reduce the effects of capacitive and inductive noise coupled in the sense traces on the PCB. A typical filter consists of two series 10 Ω resistors connected to a parallel 1000pF capacitor, resulting in a time constant of 20ns. This same RC filter, with minor modifications, can be used to extract the resistive component of the current sense signal in the presence of parasitic inductance. For example, Figure 3 illustrates the voltage waveform across a 2m Ω sense resistor with a 2010 footprint for the 1.2V/15A converter operating at 100% load. The waveform is the superposition of a purely resistive component and a purely inductive component. It was measured using two scope probes and waveform math to obtain a differential measurement. Based on additional measurements of the inductor ripple current and the on-time and off-time of the top switch, the value of the parasitic inductance was determined to be 0.5nH using the equation:

$$ESL = \frac{V_{ESL(STEP)} t_{ON} \cdot t_{OFF}}{\Delta I_L t_{ON} + t_{OFF}} \quad (1)$$

If the RC time constant is chosen to be close to the parasitic inductance divided by the sense resistor (L/R), the resulting waveform looks resistive again, as shown in Figure 4. For applications using low maximum sense voltages, check the sense resistor manufacturer's data

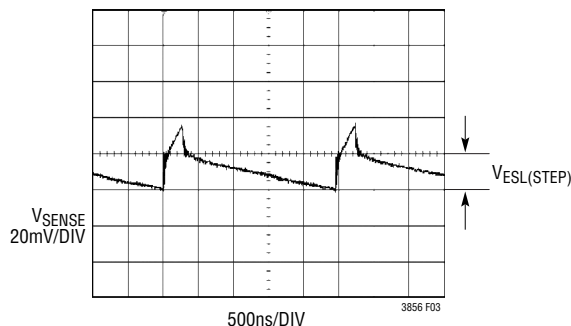

Figure 3. Voltage Waveform Measured Directly Across the Sense Resistor

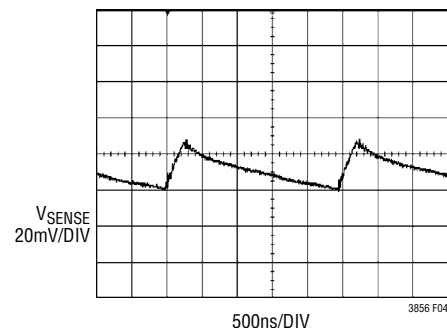

Figure 4. Voltage Waveform Measured After the Sense Resistor Filter. $C_F = 1000\text{pF}$, $R_F = 100\Omega$

APPLICATIONS INFORMATION

sheet for information about parasitic inductance. In the absence of data, measure the voltage drop directly across the sense resistor to extract the magnitude of the ESL step and use Equation 1 to determine the ESL. However, do not overfilter. Keep the RC time constant, less than or equal to the inductor time constant to maintain a high enough ripple voltage of ΔV_{SENSE} . The equation generally applies to high density/high current applications where $I_{\text{MAX}} > 10\text{A}$ and low values of inductors are used. For applications where $I_{\text{MAX}} < 10\text{A}$, set R_F to 10Ω and C_F to 1000pF . This will provide a good starting point. The filter components need to be placed close to the IC. The positive and negative sense traces need to be routed as a differential pair and Kelvin connected to the sense resistor.

Inductor DCR Sensing

For applications requiring the highest possible efficiency at high load currents, the LTC3856 is capable of sensing the voltage drop across the inductor DCR, as shown in Figure 2b. The DCR of the inductor represents the small amount of DC winding resistance of the copper, which can be less than $1\text{m}\Omega$ for today's low value, high current inductors. In a high current application requiring such an inductor, conduction loss through a sense resistor would cost several points of efficiency compared to DCR sensing. If the external $R1 \parallel R2 \cdot C1$ time constant is chosen to be exactly equal to the L/DCR time constant, the voltage drop across the external capacitor is equal to the drop across the inductor DCR multiplied by $R2/(R1 + R2)$. $R2$ scales the voltage across the sense terminals for applications where the DCR is greater than the target sense resistor value. To properly dimension the external filter components, the DCR of the inductor must be known. It can be measured using a good RLC meter, but the DCR tolerance is not always the same and varies with temperature; consult the manufacturers' data sheets for detailed information.

Using the inductor ripple current value from the Inductor Value Calculation and Output Ripple Current section, the target sense resistor value is:

$$R_{\text{SENSE(EQUIV)}} = \frac{V_{\text{SENSE(MAX)}}}{I_{\text{(MAX)}} + \frac{\Delta I_L}{2}}$$

To ensure that the application will deliver full load current over the full operating temperature range, choose the minimum value for the maximum current sense threshold ($V_{\text{SENSE(MAX)}}$) in the Electrical Characteristics table (25mV , 45mV or 68mV , depending on the state of the I_{LIM} pin). Next, determine the DCR of the inductor. Where provided, use the manufacturer's maximum value, usually given at 20°C . Increase this value to account for the temperature coefficient of resistance, which is approximately $0.4\%/^\circ\text{C}$. A conservative value for $T_{\text{L(MAX)}}$ is 100°C . To scale the maximum inductor DCR to the desired sense resistor value, use the divider ratio:

$$R_D = \frac{R_{\text{SENSE(EQUIV)}}}{\text{DCR}_{\text{MAX}} \text{ at } T_{\text{L(MAX)}}}$$

$C1$ is usually selected to be in the range of $0.047\mu\text{F}$ to $0.47\mu\text{F}$. This forces $R1 \parallel R2$ to around 2k , reducing error that might have been caused by the SENSE^+ pins' $\pm 1\mu\text{A}$ current. $T_{\text{L(MAX)}}$ is the maximum inductor temperature. The equivalent resistance $R1 \parallel R2$ is scaled to the room temperature inductance and maximum DCR:

$$R1 \parallel R2 = \frac{L}{(\text{DCR at } 20^\circ\text{C}) \cdot C1}$$

The sense resistor values are:

$$R1 = \frac{R1 \parallel R2}{R_D}; \quad R2 = \frac{R1 \cdot R_D}{1 - R_D}$$

APPLICATIONS INFORMATION

The LTC3856 also features a DCR temperature compensation circuit by using a NTC temperature sensor. See the Inductor DCR Sensing Temperature Compensation and the ITEMP Pin section for details.

The maximum power loss in R1 is related to duty cycle, and will occur in continuous mode at the maximum input voltage:

$$P_{\text{LOSS R1}} = \frac{(V_{\text{IN(MAX)}} - V_{\text{OUT}}) \cdot V_{\text{OUT}}}{R1}$$

Ensure that R1 has a power rating higher than this value. If high efficiency is necessary at light loads, consider this power loss when deciding whether to use DCR sensing or sense resistors. Light load power loss can be modestly higher with a DCR network than with a sense resistor, due to the extra switching losses incurred through R1. However, DCR sensing eliminates a sense resistor, reduces conduction losses and provides higher efficiency at heavy loads. Peak efficiency is about the same with either method. To maintain a good signal-to-noise ratio for the current sense signal, use a minimum ΔV_{SENSE} of 10mV for duty cycles less than 40%. For a DCR sensing application, the actual ripple voltage will be determined by the equation:

$$\Delta V_{\text{SENSE}} = \frac{V_{\text{IN}} - V_{\text{OUT}}}{R1 \cdot C1} \cdot \frac{V_{\text{OUT}}}{V_{\text{IN}} \cdot f_{\text{OSC}}}$$

Inductor DCR Sensing Temperature Compensation and the ITEMP Pin

Inductor DCR current sensing provides a lossless method of sensing the instantaneous current. Therefore, it can provide higher efficiency for applications of high output currents. However, the DCR of the inductor, which is the small amount of DC winding resistance of the copper, typically has a positive temperature coefficient. As the temperature of the inductor rises, its DCR value increases. The current limit of the controller is therefore reduced.

The LTC3856 offers a method to counter this inaccuracy by allowing the user to place an NTC temperature sensing resistor near the inductor to actively correct this error. The ITEMP pin, when left floating, is at a voltage around 5V and

DCR temperature compensation is disabled. The ITEMP pin has a constant 10 μ A precision current flowing out of the pin. By connecting an NTC resistor from the ITEMP pin to SGND, the maximum current sense threshold can be varied over temperature according to the following equation:

$$V_{\text{SENSEMAX(ADJ)}} = V_{\text{SENSE(MAX)}} \cdot \frac{1.8 - V_{\text{ITEMP}}}{1.3}$$

where:

$V_{\text{SENSEMAX(ADJ)}}$ is the maximum adjusted current sense threshold at temperature.

$V_{\text{SENSE(MAX)}}$ is the maximum current sense threshold specified in the Electrical Characteristics table. It is typically 75mV, 50mV or 30mV, depending on the setting I_{LIM} pins.

V_{ITEMP} is the voltage of the ITEMP pin.

The valid voltage range for DCR temperature compensation on the ITEMP pin is between 0.5V to 0.2V, with 0.5V or above being no DCR temperature correction and 0.2V the maximum correction. However, if the duty cycle of the controller is less than 25%, the ITEMP range is extended from 0.5V to 0V.

The NTC resistor has a negative temperature coefficient, meaning its value decreases as temperature rises. The V_{ITEMP} voltage, therefore, decreases as temperature increases and in turn, the $V_{\text{SENSEMAX(ADJ)}}$ will increase to compensate the DCR temperature coefficient. The NTC resistor, however, is nonlinear and the user can linearize its value by building a resistor network with regular resistors. Consult the NTC manufacture data sheets for detailed information.

Another use for the ITEMP pins, in addition to NTC compensated DCR sensing, is adjusting $V_{\text{SENSE(MAX)}}$ to values between the nominal values of 30mV, 50mV and 75mV for a more precise current limit. This is done by applying a voltage less than 0.5V to the ITEMP pin. $V_{\text{SENSE(MAX)}}$ will be varied per the previous equation and the same duty cycle limitations will apply. The current limit can be adjusted using this method either with a sense resistor or DCR sensing.

APPLICATIONS INFORMATION

NTC Compensated DCR Sensing

For DCR sensing applications where a more accurate current limit is required, a network consisting of an NTC thermistor placed from the ITEMP pin to ground will provide correction of the current limit over temperature. Figure 2b shows this network. Resistors R_S and R_P will linearize the impedance the ITEMP pin sees. To implement NTC compensated DCR sensing, design the DCR sense filter network per the same procedure mentioned in the previous selection, except calculate the divider components using the room temperature value of the DCR. For a typical application:

1. Set the ITEMP pin resistance to 50k at 25°C. With 10µA flowing out of the ITEMP pin, the voltage on the ITEMP pin will be 0.5V at room temperature. Current limit correction will occur for inductor temperatures greater than 25°C.
2. Calculate the ITEMP pin resistance and the maximum inductor temperature, which is typically 100°C. Use the following equations:

$$R_{\text{ITEMP}100\text{C}} = \frac{V_{\text{ITEMP}100\text{C}}}{10\mu\text{A}}$$

$$V_{\text{ITEMP}100\text{C}} = 0.5\text{V} - 1.3 \cdot \frac{I_{\text{MAX}} \cdot \text{DCR}_{\text{MAX}} \cdot \frac{R_2}{R_1+R_2} \cdot (100^\circ\text{C} - 25^\circ\text{C}) \cdot \frac{0.4}{100}}{V_{\text{SENSE}(\text{MAX})}}$$

Calculate the values for R_P and R_S . A simple method is to graph the following R_S versus R_P equations with R_S on the y-axis and R_P on the x-axis.

$$R_S = R_{\text{ITEMP}25\text{C}} - R_{\text{NTC}25\text{C}} \parallel R_P$$

$$R_S = R_{\text{ITEMP}100\text{C}} - R_{\text{NTC}100\text{C}} \parallel R_P$$

Next, find the value of R_P that satisfies both equations, which will be the point where the curves intersect. Once R_P is known, solve for R_S .

The resistance of the NTC thermistor can be obtained from the vendor's data sheet either in the form of graphs, tabulated data or formulas. The approximate value for the NTC thermistor for a given temperature can be calculated from the following equation:

$$R = R_0 \cdot \exp \left[B \cdot \left(\frac{1}{T+273} - \frac{1}{T_0+273} \right) \right]$$

Where

R = resistance at temperature T , in degrees C
 R_0 = resistance at temperature T_0 , typically 25°C
 B = B-constant of the thermistor.

Figure 5 shows a typical resistance curve for a 100k thermistor and the ITEMP pin network over temperature.

Starting values for the NTC compensation network are:

- NTC $R_0 = 100\text{k}$
- $R_S = 20\text{k}$
- $R_P = 50\text{k}$

But, the final values should be calculated using the previous equations and checked at 25°C and 100°C.

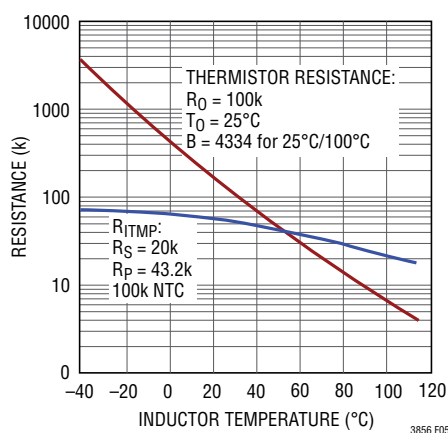

Figure 5. Resistance vs Temperature for the ITEMP Pin Network and the 100k NTC

APPLICATIONS INFORMATION

After determining the components for the temperature compensation network, check the results by plotting I_{MAX} versus inductor temperature using the following equations:

$$I_{MAX} = \frac{V_{SENSEMAX(ADJ)} - \frac{\Delta V_{SENSE}}{2}}{DCR_{MAX} \text{ AT } 25^{\circ}\text{C} \cdot \left[1 + (T_{L(MAX)} - 25^{\circ}\text{C}) \cdot \frac{0.4}{100} \right]}$$

where

$$V_{SENSEMAX(ADJ)} = V_{SENSE(MAX)} \cdot \frac{1.8\text{V} - V_{ITMP}}{1.3} - A$$

$$V_{ITMP} = 10\mu\text{A} \cdot (R_S + R_P || R_{NTC})$$

Use typical values for $V_{SENSE(MAX)}$. Subtracting constant A will provide a minimum value for $V_{SENSE(MAX)}$. These values are summarized in Table 2.

Table 2. Values for $V_{SENSE(MAX)}$

I_{LIM}	GND	FLOAT	INTV _{CC}
$V_{SENSE(MAX)}$ Typ	30mV	50mV	75mV
A	5mV	5mV	7mV

The resulting current limit should be greater than or equal to I_{MAX} for inductor temperatures between 25°C and 100°C.

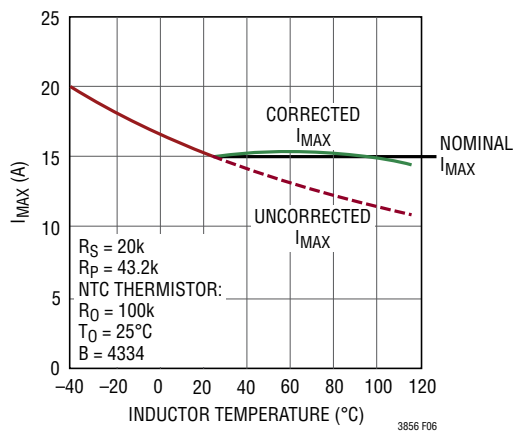

Figure 6. Worst Case I_{MAX} vs Inductor Temperature Curve with and without NTC Temperature Compensation

Typical values for the NTC compensation network are:

- NTC $R_0 = 100\text{k}$, B-constant = 3000 to 4000
- $R_S \approx 20\text{k}$
- $R_P \approx 50\text{k}$

Another approach for generating the I_{MAX} versus inductor temperature curve plot is to first use the aforementioned values as a starting point and then adjusting the R_S and R_P values as necessary. Figure 6 shows a typical curve of I_{MAX} versus inductor temperature.

The same thermistor network can be used to correct for temperatures less than 25°C. But, ensure that V_{ITMP} is greater than 0.2V for duty cycles of 25% or more, otherwise temperature correction may not occur at elevated ambients. For the most accurate temperature detection, place the thermistor next to the inductors, as shown in Figure 7. Take care to keep the I_{TEMP} pins away from the switch nodes.

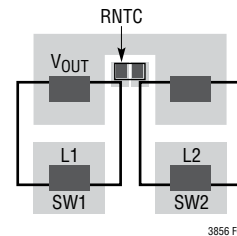

Figure 7. Thermistor Location. Place Thermistor Next to Inductor(s) for Accurate Sensing of the Inductor Temperature, But Keep the I_{TEMP} Pin Away from the Switch Nodes and Gate Drive Traces.

Slope Compensation and Inductor Peak Current

Slope compensation provides stability in constant-frequency, current mode architectures by preventing subharmonic oscillation at high duty cycles. It is accomplished internally by adding a compensating ramp to the inductor current signal at duty cycles in excess of 40%. Normally, this results in a reduction of maximum inductor peak current for duty cycles greater than 40%. However, the LTC3856 uses a scheme that counteracts this compensating ramp, which allows the maximum inductor peak current to remain unaffected throughout all duty cycles.

APPLICATIONS INFORMATION

Inductor Value Calculation and Output Ripple Current

The operating frequency and inductor selection are inter-related in that higher operating frequencies allow the use of smaller inductor and capacitor values. A higher frequency generally results in lower efficiency because of MOSFET gate charge and transition losses. In addition to this basic trade-off, the effect of inductor value on ripple current and low current operation must also be considered. The PolyPhase approach reduces both input and output ripple currents while optimizing individual output stages to run at a lower fundamental frequency, enhancing efficiency.

The inductor value has a direct effect on ripple current. The inductor ripple current, ΔI_L , per individual section N , decreases with higher inductance or frequency and increases with higher V_{IN} or V_{OUT} :

$$\Delta I_L = \frac{V_{OUT}}{f_{OSC} \cdot L} \left(1 - \frac{V_{OUT}}{V_{IN}} \right)$$

where f_{OSC} is the individual output stage operating frequency.

In a PolyPhase converter, the net ripple current seen by the output capacitor is much smaller than the individual inductor ripple currents due to the ripple cancellation. The details on how to calculate the net output ripple current can be found in Application Note 77.

Figure 8 shows the net ripple current seen by the output capacitors for the different phase configurations. The

output ripple current is plotted for a fixed output voltage as the duty factor is varied between 10% and 90% on the x-axis. The output ripple current is normalized against the inductor ripple current at zero duty factor. The graph can be used in place of tedious calculations. The zero output ripple current is obtained when:

$$\frac{V_{OUT}}{V_{IN}} = \frac{k}{N} \text{ where } k = 1, 2, \dots, N-1$$

Power MOSFET and Schottky Diode (Optional) Selection

At least two external power MOSFETs must be selected for each power stage: One N-channel MOSFET for the top (main) switch and one or more N-channel MOSFET(s) for the bottom (synchronous) switch. The number, type and on-resistance of all MOSFETs selected take into account the voltage step-down ratio as well as the actual position (main or synchronous) in which the MOSFET will be used. A much smaller and much lower input capacitance MOSFET should be used for the top MOSFET in applications that have an output voltage that is less than one-third of the input voltage. In applications where $V_{IN} \gg V_{OUT}$, the top MOSFETs' on-resistance is normally less important for overall efficiency than its input capacitance at operating frequencies above 300kHz. MOSFET manufacturers have designed special purpose devices that provide reasonably low on-resistance with significantly reduced input capacitance for the main switch application in switching regulators.

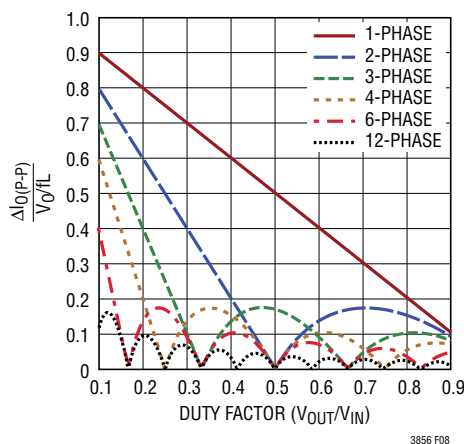

Figure 8. Normalized Peak Output Current vs Duty Factor [$I_{RMS} = 0.3(I_{OP-P})$]

3856fa

APPLICATIONS INFORMATION

The peak-to-peak MOSFET gate drive levels are set by the voltage, V_{CC} , requiring the use of logic-level threshold MOSFETs in most applications. Pay close attention to the BV_{DSS} specification for the MOSFETs as well; many of the logic-level MOSFETs are limited to 30V or less. Selection criteria for the power MOSFETs include the on-resistance, $R_{DS(ON)}$, input capacitance, input voltage and maximum output current. MOSFET input capacitance is a combination of several components but can be taken from the typical gate charge curve included on most data sheets (Figure 9). The curve is generated by forcing a constant input current into the gate of a common source, current source loaded stage, then plotting the gate voltage versus time.

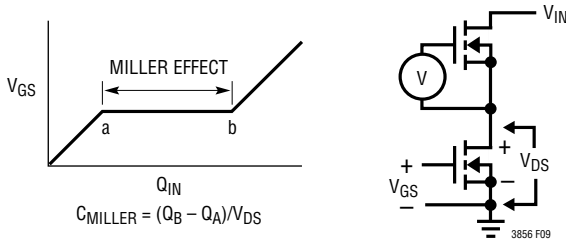

Figure 9. Gate Charge Characteristic

The initial slope is the effect of the gate-to-source and the gate-to-drain capacitance. The flat portion of the curve is the result of the Miller multiplication effect of the drain-to-gate capacitance as the drain drops the voltage across the current source load. The upper sloping line is due to the drain-to-gate accumulation capacitance and the gate-to-source capacitance. The Miller charge (the increase in coulombs on the horizontal axis from a to b while the curve is flat) is specified for a given V_{DS} drain voltage, but can be adjusted for different V_{DS} voltages by multiplying the ratio of the application V_{DS} to the curve specified V_{DS} values. A way to estimate the C_{MILLER} term is to take the change in gate charge from points a and b on a manufacturer's data sheet and divide by the stated V_{DS} voltage specified. C_{MILLER} is the most important selection criteria for determining the transition loss term in the top MOSFET but is not directly specified on MOSFET data sheets. C_{RSS} and C_{OS} are specified sometimes but

definitions of these parameters are not included. When the controller is operating in continuous mode, the duty cycles for the top and bottom MOSFETs are given by:

$$\text{Main Switch Duty Cycle} = \frac{V_{OUT}}{V_{IN}}$$

$$\text{Synchronous Switch Duty Cycle} = \left(\frac{V_{IN} - V_{OUT}}{V_{IN}} \right)$$

The power dissipation for the main and synchronous MOSFETs at maximum output current are given by:

$$P_{MAIN} = \frac{V_{OUT}}{V_{IN}} \left(\frac{I_{MAX}}{N} \right)^2 (1 + \delta) R_{DS(ON)} +$$

$$(V_{IN})^2 \left(\frac{I_{MAX}}{2N} \right) (R_{DR}) (C_{MILLER}) \cdot$$

$$\left[\frac{1}{V_{CC} - V_{TH(IL)}} + \frac{1}{V_{TH(IL)}} \right] \cdot f$$

$$P_{SYNC} = \frac{V_{IN} - V_{OUT}}{V_{IN}} \left(\frac{I_{MAX}}{N} \right)^2 (1 + \delta) R_{DS(ON)}$$

where N is the number of output stages, δ is the temperature dependency of $R_{DS(ON)}$, R_{DR} is the effective top driver resistance (approximately 2Ω at $V_{GS} = V_{MILLER}$), V_{IN} is the drain potential and the change in drain potential in the particular application. $V_{TH(IL)}$ is the data sheet specified typical gate threshold voltage specified in the power MOSFET data sheet at the specified drain current. C_{MILLER} is the calculated capacitance using the gate charge curve from the MOSFET data sheet and the technique just described.

Both MOSFETs have I^2R losses while the topside N-channel equation includes an additional term for transition losses, which peak at the highest input voltage. For $V_{IN} < 20V$, the high current efficiency generally improves with larger MOSFETs, while for $V_{IN} > 20V$, the transition losses rapidly increase to the point that the use of a higher $R_{DS(ON)}$ device with lower C_{MILLER} actually provides higher efficiency. The synchronous MOSFET losses are greatest at high input voltage when the top switch duty factor is low, or during a short-circuit when the synchronous switch is on close to 100% of the period.

APPLICATIONS INFORMATION

The term $(1 + \delta)$ is generally given for a MOSFET in the form of a normalized $R_{DS(ON)}$ vs temperature curve, but $\delta = 0.005/^\circ\text{C}$ can be used as an approximation for low voltage MOSFETs.

The optional Schottky diodes conduct during the dead time between the conduction of the two large power MOSFETs. This prevents the body diode of the bottom MOSFET from turning on, storing charge during the dead time and requiring a reverse-recovery period which could cost as much as several percent in efficiency. A 2A to 8A Schottky is generally a good compromise for both regions of operation due to the relatively small average current. Larger diodes result in additional transition loss due to their larger junction capacitance. A Schottky diode in parallel with the bottom FET may also provide a modest improvement in Burst Mode efficiency.

C_{IN} and C_{OUT} Selection

In continuous mode, the source current of each top N-channel MOSFET is a square wave of duty cycle V_{OUT}/V_{IN} . A low ESR input capacitor sized for the maximum RMS current must be used. The details of a close form equation can be found in Application Note 77. Figure 10 shows the input capacitor ripple current for different phase configurations with the output voltage fixed and input voltage varied. The input ripple current is normalized against the DC output current. The graph can be used in place of tedious calculations. The minimum input ripple current can be achieved when the product of phase number and

output voltage, $N(V_{OUT})$, is approximately equal to the input voltage, V_{IN} , or:

$$\frac{V_{OUT}}{V_{IN}} = \frac{k}{N} \text{ where } k=1, 2, \dots, N-1$$

So, the phase number can be chosen to minimize the input capacitor size for the given input and output voltages. In the graph of Figure 10, the local maximum input RMS capacitor currents are reached when:

$$\frac{V_{OUT}}{V_{IN}} = \frac{2k-1}{N} \text{ where } k=1, 2, \dots, N$$

These worst-case conditions are commonly used for design because even significant deviations do not offer much relief. Note that capacitor manufacturer's ripple current ratings are often based on only 2000 hours of life. This makes it advisable to further derate the capacitor or to choose a capacitor rated at a higher temperature than required. Several capacitors may also be paralleled to meet size or height requirements in the design. Always consult the capacitor manufacturer if there is any question.

The Figure 10 graph shows that the peak RMS input current is reduced linearly, inversely proportional to the number N of stages used. It is important to note that the efficiency loss is proportional to the input RMS current squared and therefore a 3-stage implementation results in 90% less power loss when compared to a single-phase design. Battery/input protection fuse resistance (if used), PC board trace and connector resistance losses are also

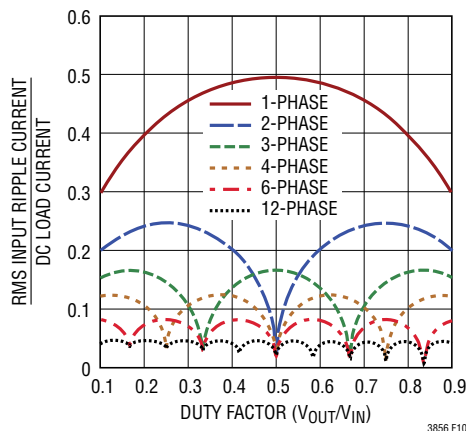

Figure 10. Normalized Input RMS Ripple Current vs Duty Factor for One to Six Output Stages

3856fa

APPLICATIONS INFORMATION

reduced by the reduction of the input ripple current in a PolyPhase system. The required amount of input capacitance is further reduced by the factor N, due to the effective increase in the frequency of the current pulses. Ceramic capacitors are becoming very popular for small designs but several cautions should be observed. X7R, X5R and Y5V are examples of a few of the ceramic materials used as the dielectric layer, and these different dielectrics have very different effect on the capacitance value due to the voltage and temperature conditions applied. Physically, if the capacitance value changes due to applied voltage change, there is a concomitant piezo effect which results in radiating sound! A load that draws varying current at an audible rate may cause an attendant varying input voltage on a ceramic capacitor, resulting in an audible signal. A secondary issue relates to the energy flowing back into a ceramic capacitor whose capacitance value is being reduced by the increasing charge. The voltage can increase at a considerably higher rate than the constant current being supplied because the capacitance value is decreasing as the voltage is increasing! Nevertheless, ceramic capacitors, when properly selected and used, can provide the lowest overall loss due to their extremely low ESR.

The selection of C_{OUT} is driven by the required effective series resistance (ESR). Typically once the ESR requirement is satisfied the capacitance is adequate for filtering. The steady-state output ripple (ΔV_{OUT}) is determined by:

$$\Delta V_{OUT} \approx \Delta I_L \left(ESR + \frac{1}{8NfC_{OUT}} \right)$$

where f = operating frequency of each stage, N = the number of output stages, C_{OUT} = output capacitance and ΔI_L = ripple current in each inductor. The output ripple is highest at maximum input voltage since ΔI_L increases with input voltage. The output ripple will be less than 50mV at maximum V_{IN} with $\Delta I_L = 0.4I_{OUT(MAX)}$ assuming:

$$C_{OUT} \text{ required ESR} < N \cdot R_{SENSE}$$

and

$$C_{OUT} > \frac{1}{(8Nf)(R_{SENSE})}$$

The emergence of very low ESR capacitors in small, surface mount packages makes very small physical implementa-

tions possible. The ability to externally compensate the switching regulator loop using the I_{TH} pin allows a much wider selection of output capacitor types. The impedance characteristic of each capacitor type is significantly different than an ideal capacitor and therefore requires accurate modeling or bench evaluation during design. Manufacturers such as Nichicon, Nippon Chemi-Con and Sanyo should be considered for high performance through-hole capacitors. The OS-CON semiconductor dielectric capacitors available from Sanyo and the Panasonic SP surface mount types have a good (ESR)(size) product.

Once the ESR requirement for C_{OUT} has been met, the RMS current rating generally far exceeds the $I_{RIPPLE(P-P)}$ requirement. Ceramic capacitors from AVX, Taiyo Yuden and Murata offer high capacitance value and very low ESR, especially applicable for low output voltage applications.

In surface mount applications, multiple capacitors may have to be paralleled to meet the ESR or RMS current handling requirements of the application. Aluminum electrolytic and dry tantalum capacitors are both available in surface mount configurations. New special polymer surface mount capacitors offer very low ESR also but have much lower capacitive density per unit volume. In the case of tantalum, it is critical that the capacitors are surge tested for use in switching power supplies. Several excellent choices are the AVX TPS, AVX TPSV, the KEMET T510 series of surface mount tantalums or the Panasonic SP series of surface mount special polymer capacitors available in case heights ranging from 2mm to 4mm. Other capacitor types include Sanyo POSCAP, Sanyo OS-CON, Nichicon PL series and Sprague 595D series. Consult the manufacturers for other specific recommendations.

Differential Amplifier

The LTC3856 has a true remote voltage sense capability. The sensing connections should be returned from the load, back to the differential amplifier's inputs through a common, tightly coupled pair of PC traces. The differential amplifier rejects common mode signals capacitively or inductively radiated into the feedback PC traces as well as ground loop disturbances. The differential amplifier output signal is divided by a pair of resistors and is compared with the internal, precision 0.6V voltage reference by the

3856fa

APPLICATIONS INFORMATION

error amplifier. The amplifier has an output swing range of 0V to 3.6V. The output uses an NPN emitter follower with 80k feedback resistance.

Active Voltage Positioning (AVP)

In an application, the AVP scheme modifies the regulated output voltage depending on its current loading. AVP can improve overall transient response and save power consumption.

The LTC3856 senses inductor current information by monitoring voltage drops across the sense resistors R_{SENSE} or the DCR sensing network of the two channels. The voltage drops are added together and applied as $V_{PRE-AVP}$ between the AVP and DIFFP pins, which are connected through resistor $R_{PRE-AVP}$. Then $V_{PRE-AVP}$ is scaled through R_{AVP} and added to output voltage as the compensation for the load voltage drop.

Let:

$$\Delta V = V_{SENSE1^+} - V_{SENSE1^-}$$

$$\Delta V = V_{SENSE2^+} - V_{SENSE2^-}$$

then:

$$\Delta V_{DIFFP, VOUT} = 2 \cdot \Delta V \left(\frac{R_{AVP}}{R_{PRE-AVP}} \right)$$

The final load slope is defined by the inductor current sense resistors and the two external resistors previously mentioned.

In summary, the load slope is:

$$\left(R_{SENSE} \cdot \frac{R_{AVP}}{R_{PRE-AVP}} \right) V/A$$

The recommended value for R_{AVP} is 90Ω to 100Ω. The maximum output voltage at AVP is 2.5V. Therefore, for outputs higher than 2.5V, the AVP function is not supported. The DIFFP pin, however, should always be connected to the

output even when AVP or diffamp functions are not used. When AVP function is not desired, float the AVP pin or connect a resistor between the AVP pin and DIFFP pin. $R_{PRE-AVP}$ on the order of 1kΩ is recommended.

Programmable Stage Shedding Mode

When the MODE pin is tied to $INTV_{CC}$, the LTC3856 enters Stage Shedding mode. This means that the second channel will stop switching when I_{TH} is below a certain programmed threshold. This threshold voltage on I_{TH} is programmed according to the following formula:

$$V_{SHED} = 0.5 + \left(\frac{5}{3} \right) \cdot (0.5 - V_{ISET})$$

The valid range of V_{ISET} is between 0V to 0.5V, where V_{ISET} is the voltage on the ISET pin. There is a precision 7.5μA flowing out of the ISET pin. Connecting a resistor to SGND sets the V_{ISET} voltage. When left floating, V_{ISET} voltage will be at $INTV_{CC}$. The Stage Shedding mode threshold voltage in this case will be 0.5V. There is a 50mV hysteresis for the Stage Shedding mode threshold comparator.

Programmable Burst Mode Operation

When the MODE pin is floating, the LTC3856 enters Burst Mode operation. This means that both channels will stop switching when I_{TH} is below a certain threshold.

The Burst Mode clamp, which sets the current limit when bursting, can be programmed through V_{ISET} according to the following formula:

$$V_{CLAMP} = 0.7 + 0.62 (0.5 - V_{ISET})$$

The valid range of V_{ISET} is between 0.3V to 0.5V and V_{ISET} is the voltage on the ISET pin. There is a precision 7.5μA flowing out of ISET. Connecting a resistor to SGND sets the V_{ISET} voltage. When left floating, V_{ISET} will be at $INTV_{CC}$. The Burst Mode clamp voltage in this case will be 0.7V. There is a 50mV hysteresis for the Burst Mode comparator.

APPLICATIONS INFORMATION

Soft-Start and Tracking

The LTC3856 has the ability to either soft-start by itself with a capacitor or track the output of another external supply. When the controller is configured to soft-start by itself, a capacitor should be connected to its TK/SS pin. The controller is in the shutdown state if its RUN pin voltage is below 1.22V and its TK/SS pin is actively pulled to ground in this shutdown state.

Once the RUN pin voltage is above 1.22V, the controller powers up. A soft-start current of 1.25 μ A then starts to charge the TK/SS soft-start capacitor. Note that soft-start or tracking is achieved not by limiting the maximum output current of the controller but by controlling the output ramp voltage according to the ramp rate on the TK/SS pin. Current foldback is disabled during this phase to ensure smooth soft-start or tracking. The soft-start or tracking range is defined to be the voltage range from 0V to 0.6V on the TK/SS pin. The total soft-start time can be calculated as:

$$t_{\text{SOFTSTART}} = 0.6 \cdot \frac{C_{\text{SS}}}{1.25\mu\text{A}}$$

Regardless of the mode selected by the MODE pin, the controller always starts in discontinuous mode up to TK/SS = 0.5V. Between TK/SS = 0.5V and 0.54V, it will operate in forced continuous mode and revert to the selected mode once TK/SS > 0.54V. The output ripple is minimized during the 40mV forced continuous mode window ensuring a clean PGOOD signal.

When the channel is configured to track another supply, the feedback voltage of the other supply is duplicated by a resistor divider and applied to the TK/SS pin. Therefore, the voltage ramp rate on this pin is determined by the ramp rate of the other supply's voltage. Note that the small soft-start capacitor charging current is always flowing, producing a small offset error. To minimize this error, select the tracking resistive divider value to be small enough to make this error negligible. In order to track down another channel or supply after the soft-start phase expires, the LTC3856 is forced into continuous mode of operation as soon as V_{FB} is below the undervoltage threshold of 0.54V regardless of the setting on the MODE pin. However, the LTC3856 should always be set in forced continuous mode

tracking down when there is no load. After TK/SS drops below 0.1V, the controller operates in discontinuous mode.

The LTC3856 allows the user to program how its output ramps up and down by means of the TK/SS pins. Through these pins, the output can be set up to either coincidentally or ratiometrically track another supply's output, as shown in Figure 11. In the following discussions, V_{OUT1} refers to the LTC3856's output as a master and V_{OUT2} refers to another supply output as a slave. To implement the coincident tracking in Figure 11a, connect an additional resistive divider to V_{OUT1} and connect its mid-point to the TK/SS pin of the slave controller. The ratio of this divider should be the same as that of the slave controller's feedback divider shown in Figure 12a. In this tracking mode, V_{OUT1} must be set higher than V_{OUT2} . To implement the ratiometric tracking in Figure 11b, the ratio of the V_{OUT2} divider should be exactly the same as the master controller's feedback divider shown in Figure 12b. By selecting different resistors, the LTC3856 can achieve different modes of tracking including the two in Figure 11.

So, which mode should be programmed? While either mode in Figure 11 satisfies most practical applications, some trade-offs exist. The ratiometric mode saves a pair of resistors, but the coincident mode offers better output regulation. Under ratiometric tracking, when the master controller's output experiences dynamic excursion (under load transient, for example), the slave controller output will be affected as well. For better output regulation, use the coincident tracking mode instead of ratiometric.

INTV_{CC} (LDO) and EXTV_{CC}

The LTC3856 features a true PMOS LDO that supplies power to INTV_{CC} from the V_{IN} supply. INTV_{CC} powers the gate drivers and much of the LTC3856's internal circuitry. The LDO regulates the voltage at the INTV_{CC} pin to 5V when V_{IN} is greater than 5.5V. EXTV_{CC} connects to INTV_{CC} through a P-channel MOSFET and can supply the needed power when its voltage is higher than 4.7V. Each of these can supply a peak current of 100mA and must be bypassed to ground with a minimum of 4.7 μ F ceramic capacitor or other low ESR capacitor. No matter what type of bulk capacitor is used, an additional 0.1 μ F ceramic capacitor placed directly adjacent to the INTV_{CC} and PGND pins is

APPLICATIONS INFORMATION

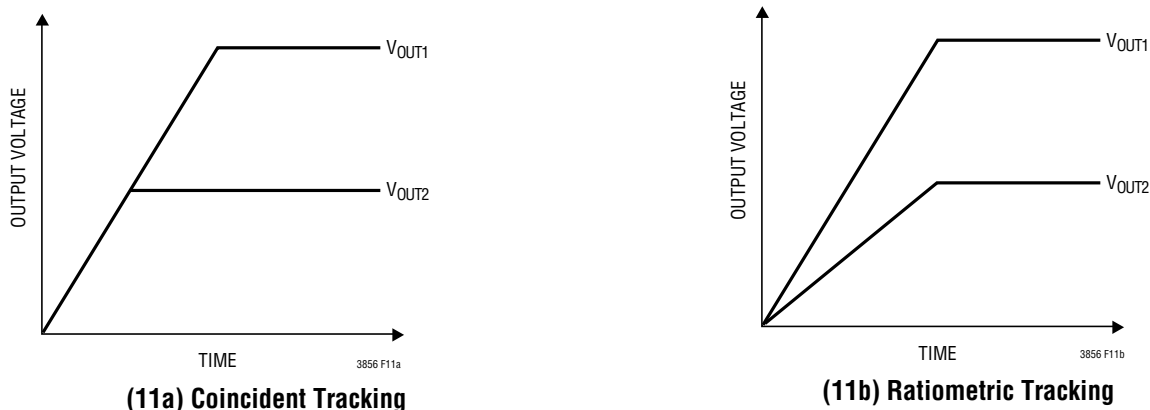

Figure 11. Two Different Modes of Output Voltage Tracking

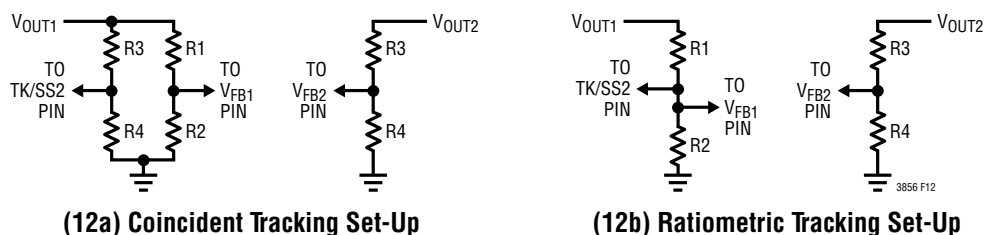

Figure 12. Set-Up and Coincident and Ratiometric Tracking

highly recommended. Good bypassing is needed to supply the high transient currents required by the MOSFET gate drivers and to prevent interaction between the channels.

High input voltage applications in which large MOSFETs are being driven at high frequencies may cause the maximum junction temperature rating for the LTC3856 to be exceeded. The $INTV_{CC}$ current, which is dominated by the gate charge current, may be supplied by either the 5V LDO or $EXTV_{CC}$. When the voltage on the $EXTV_{CC}$ pin is less than 4.7V, the LDO is enabled. Power dissipation for the IC in this case is highest and is equal to $V_{IN} \cdot I_{INTVCC}$. The gate charge current is dependent on operating frequency as discussed in the Efficiency Considerations section. The junction temperature can be estimated by using the equations given in Note 3 of the Electrical Characteristics

table. For example, the LTC3856 $INTV_{CC}$ current is limited to less than 42mA from a 38V supply in the UH package and not using the $EXTV_{CC}$ supply:

$$T_J = 70^\circ\text{C} + (42\text{mA})(38\text{V})(34^\circ\text{C/W}) = 125^\circ\text{C}$$

To prevent the maximum junction temperature from being exceeded, the input supply current must be checked while operating in continuous conduction mode (MODE = SGND) at maximum V_{IN} . When the voltage applied to $EXTV_{CC}$ rises above 4.7V, the $INTV_{CC}$ LDO is turned off and the $EXTV_{CC}$ is connected to the $INTV_{CC}$. The $EXTV_{CC}$ remains on as long as the voltage applied to $EXTV_{CC}$ remains above 4.5V. Using the $EXTV_{CC}$ allows the MOSFET driver and control power to be derived from one of switching regulator outputs during normal operation and from the $INTV_{CC}$ when the output is out of regulation (e.g., start-up,

APPLICATIONS INFORMATION

short circuit). If more current is required through the $EXTV_{CC}$ than is specified, an external Schottky diode can be added between the $EXTV_{CC}$ and $INTV_{CC}$ pins. Do not apply more than 6V to the $EXTV_{CC}$ pin and make sure that $EXTV_{CC} < V_{IN}$.

Significant efficiency and thermal gains can be realized by powering $INTV_{CC}$ from the output, since the V_{IN} current resulting from the driver and control currents will be scaled by a factor of (duty cycle)/(switcher efficiency). Tying the $EXTV_{CC}$ pin to a 5V supply reduces the junction temperature in the previous example from 125°C to:

$$T_J = 70^\circ\text{C} + (42\text{mA})(5\text{V})(34^\circ\text{C/W}) = 77^\circ\text{C}$$

However, for low voltage outputs, additional circuitry is required to derive $INTV_{CC}$ power from the output.

The following list summarizes the four possible connections for $EXTV_{CC}$:

1. $EXTV_{CC}$ left open (or grounded). This will cause $INTV_{CC}$ to be powered from the internal 5V LDO resulting in an efficiency penalty of up to 10% at high input voltages.
2. $EXTV_{CC}$ connected directly to V_{OUT} . This is the normal connection for a 5V regulator and provides the highest efficiency.
3. $EXTV_{CC}$ connected to an external supply. If a 5V external supply is available, it may be used to power $EXTV_{CC}$ providing it is compatible with the MOSFET gate drive requirements.
4. $EXTV_{CC}$ connected to an output-derived boost network. For 3.3V and other low voltage regulators, efficiency gains can still be realized by connecting $EXTV_{CC}$ to an output-derived voltage that has been boosted to greater than 4.7V.

For applications where the main input power is 5V, tie the V_{IN} and $INTV_{CC}$ pins together and tie the combined pins to the 5V input with a 1Ω or 2.2Ω resistor (as shown in Figure 13) to minimize the voltage drop caused by the gate charge current. This will override the $INTV_{CC}$ linear regulator and will prevent $INTV_{CC}$ from dropping too low due to the dropout voltage. Make sure the $INTV_{CC}$ voltage is at or exceeds the $R_{DS(ON)}$ test voltage for the MOSFET, which is typically 4.5V for logic-level devices.

Topside MOSFET Driver Supply (C_B , D_B)

External bootstrap capacitors, C_B , connected to the BOOST pins supply the gate drive voltages for the topside MOSFETs. Capacitor C_B in the Functional Diagram is charged through external diode D_B from $INTV_{CC}$ when the SW pin is low. When one of the topside MOSFETs is to be turned on, the driver places the C_B voltage across the gate source of the desired MOSFET. This enhances the MOSFET and turns on the topside switch. The switch node voltage, SW, rises to V_{IN} and the BOOST pin follows. With the topside MOSFET on, the boost voltage is above the input supply:

$$V_{BOOST} = V_{IN} + V_{INTV_{CC}}$$

The value of the boost capacitor, C_B , needs to be 100 times that of the total input capacitance of the topside MOSFET(s). The reverse breakdown of the external Schottky diode must be greater than $V_{IN(MAX)}$. When adjusting the gate drive level, the final arbiter is the total input current for the regulator. If a change is made and the input current decreases, then the efficiency has improved. If there is no change in input current, then there is no change in efficiency.

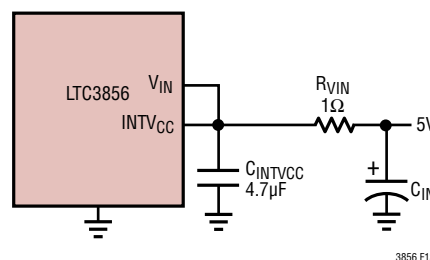

Figure 13. Set-Up for a 5V Input

3856fa

APPLICATIONS INFORMATION

Setting Output Voltage

If the DIFFAMP is not used, the LTC3856 output voltage is set by an external feedback resistive divider carefully placed across the output, as shown in Figure 14. The regulated output voltage is determined by:

$$V_{OUT} = 0.6V \cdot \left(1 + \frac{R_B}{R_A}\right)$$

To improve the frequency response, a feedforward capacitor, C_{FF} , may be used. Great care should be taken to route the V_{FB} line away from noise sources, such as the inductor or the SW line.

If the diffamp is used, then V_{FB} should be connected to the output of the diffamp, DIFFOUT, as shown in the Typical Application on the first page.

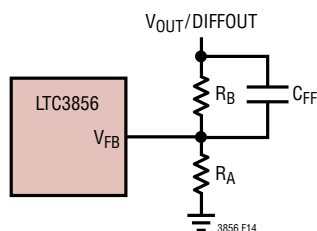

Figure 14. Setting Output Voltage without the DIFFAMP

Fault Conditions: Current Limit and Current Foldback

The LTC3856 includes current foldback to help limit load current when the output is shorted to ground. If the output falls below 50% of its nominal output level, then the maximum sense voltage is progressively lowered from its maximum programmed value to one-third of the maximum value. Foldback current limiting is disabled during the soft-start or tracking up. Under short-circuit conditions with very low duty cycles, the LTC3856 will begin cycle skipping in order to limit the short-circuit current. In this situation the bottom MOSFET will be dissipating most of the power but less than in normal operation. The short circuit ripple current is determined by the minimum on-time $t_{ON(MIN)}$ of the LTC3856 ($\approx 90ns$), the input voltage and inductor value:

$$\Delta I_{L(SC)} = t_{ON(MIN)} \cdot \frac{V_{IN}}{L}$$

The resulting short-circuit current is:

$$I_{SC} = \left(\frac{1/3 V_{SENSE(MAX)}}{R_{SENSE}} - \frac{1}{2} \Delta I_{L(SC)} \right) \cdot 2$$

APPLICATIONS INFORMATION

Phase-Locked Loop and Frequency Synchronization

The LTC3856 has a phase-locked loop (PLL) comprised of an internal voltage-controlled oscillator (V_{CO}) and a phase detector. This allows the turn-on of the top MOSFET of controller 1 to be locked to the rising edge of an external clock signal applied to the PLLIN pin. The turn-on of the second phase's top MOSFETs is thus 180° out-of-phase with the external clock, and so on. The phase detector is an edge-sensitive digital type that provides zero degrees phase shift between the external and internal oscillators. This type of phase detector does not exhibit a false lock to harmonics of the external clock.

The output of the phase detector is a pair of complementary current sources that charge or discharge the internal filter network. There is a precision $10\mu\text{A}$ of current flowing out of the FREQ pin. This allows the user to use a single resistor to SGND to set the switching frequency when no external clock

is applied to the PLLIN pin. The internal switch between the FREQ pin and the integrated PLL filter network is on, allowing the filter network to be pre-charged at the same voltage as of the FREQ pin. The relationship between the voltage on the FREQ pin and operating frequency is shown in Figure 15 and specified in the Electrical Characteristics table. If an external clock is detected on the PLLIN pin, the internal switch mentioned above turns off and isolates the influence of the FREQ pin. Note that the LTC3856 can only be synchronized to an external clock whose frequency is within range of the LTC3856's internal V_{CO} . This is guaranteed to be between 250kHz and 770kHz. A simplified block diagram is shown in Figure 16.

If the external clock frequency is greater than the internal oscillator's frequency, f_{OSC} , then current is sourced continuously from the phase detector output, pulling up the filter network. When the external clock frequency is

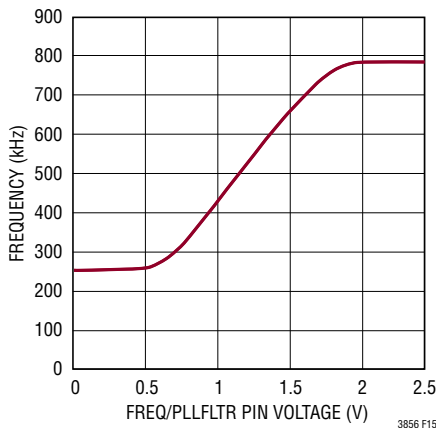

Figure 15. Relationship Between Oscillator Frequency and Voltage at the FREQ Pin

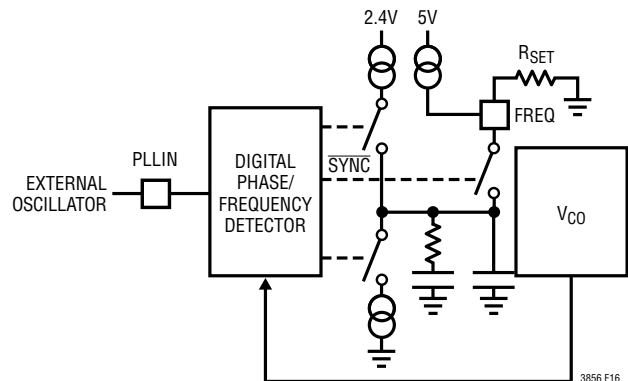

Figure 16. Phase-Locked Loop Block Diagram

APPLICATIONS INFORMATION

less than f_{OSC} , current is sunk continuously, pulling down the filter network. If the external and internal frequencies are the same but exhibit a phase difference, the current sources turn on for an amount of time corresponding to the phase difference. The voltage on the filter network is adjusted until the phase and frequency of the internal and external oscillators are identical. At the stable operating point, the phase detector output is high impedance and the filter capacitor C_{LP} holds the voltage.

Typically, the external clock (on the PLLIN pin) input high threshold is 1.6V, while the input low threshold is 1V.

Minimum On-Time Considerations

Minimum on-time, $t_{ON(MIN)}$, is the smallest time duration that the LTC3856 is capable of turning on the top MOSFET. It is determined by internal timing delays and the gate charge required to turn on the top MOSFET. Low duty cycle applications may approach this minimum on-time limit and care should be taken to ensure that:

$$t_{ON(MIN)} < \frac{V_{OUT}}{V_{IN}(f)}$$

If the duty cycle falls below what can be accommodated by the minimum on-time, the controller will begin to skip cycles. The output voltage will continue to be regulated, but the ripple voltage and current will increase. The minimum on-time for the LTC3856 is approximately 90ns, with reasonably good PCB layout, minimum 30% inductor current ripple and at least 10mV ripple on the current sense signal. The minimum on-time can be affected by PCB switching noise in the voltage and current loop. As the peak sense voltage decreases the minimum on-time gradually increases to 130ns. This is of particular concern in forced continuous applications with low ripple current at light loads. If the duty cycle drops below the minimum on-time limit in this situation, a significant amount of cycle skipping can occur with correspondingly larger current and voltage ripple.

Efficiency Considerations

The percent efficiency of a switching regulator is equal to the output power divided by the input power times 100%. It is often useful to analyze individual losses to determine what is limiting the efficiency and which change would produce the most improvement. Percent efficiency can be expressed as:

$$\% \text{Efficiency} = 100\% - (L1 + L2 + L3 + \dots)$$

where L1, L2, etc. are the individual losses as a percentage of input power.

Although all dissipative elements in the circuit produce losses, four main sources usually account for most of the losses in LTC3856 circuits: 1) IC V_{IN} current, 2) INTV_{CC} regulator current, 3) I²R losses, 4) topside MOSFET transition losses.

1. The V_{IN} current is the DC supply current given in the Electrical Characteristics table, which excludes MOSFET driver and control currents. V_{IN} current typically results in a small (<0.1%) loss.
2. INTV_{CC} current is the sum of the MOSFET driver and control currents. The MOSFET driver current results from switching the gate capacitance of the power MOSFETs. Each time a MOSFET gate is switched from low to high to low again, a packet of charge dQ moves from INTV_{CC} to ground. The resulting dQ/dt is a current out of INTV_{CC} that is typically much larger than the control circuit current. In continuous mode, $I_{GATECHG} = f(Q_T + Q_B)$, where Q_T and Q_B are the gate charges of the topside and bottom side MOSFETs. Supplying INTV_{CC} power through EXT_{CC} from an output-derived source will scale the V_{IN} current required for the driver and control circuits by a factor of (duty cycle)/(efficiency). For example, in a 20V to 5V application, 10mA of INTV_{CC} current results in approximately 2.5mA of V_{IN} current. This reduces the mid-current loss from 10% or more (if the driver was powered directly from V_{IN}) to only a few percent.
3. I²R losses are predicted from the DC resistances of the fuse (if used), MOSFET, inductor and current sense resistor. In continuous mode, the average output current flows through L and R_{SENSE}, but is chopped between

APPLICATIONS INFORMATION

the topside MOSFET and the synchronous MOSFET. If the two MOSFETs have approximately the same $R_{DS(ON)}$, then the resistance of one MOSFET can simply be summed with the resistances of L and R_{SENSE} to obtain I^2R losses. For example, if each $R_{DS(ON)} = 10m\Omega$, $R_L = 10m\Omega$, $R_{SENSE} = 5m\Omega$, then the total resistance is $25m\Omega$. This results in losses ranging from 2% to 8% as the output current increases from 3A to 15A for a 5V output, or a 3% to 12% loss for a 3.3V output.

Efficiency varies as the inverse square of V_{OUT} for the same external components and output power level. The combined effects of increasingly lower output voltages and higher currents required by high performance digital systems is not doubling but quadrupling the importance of loss terms in the switching regulator system!

- Transition losses apply only to the topside MOSFET(s), and become significant only when operating at high input voltages (typically 15V or greater). Transition losses can be estimated from:

$$\text{Transition Loss} = (1.7) V_{IN}^2 \cdot I_{O(MAX)} \cdot C_{RSS} \cdot f$$

Other hidden losses such as copper trace and internal battery resistances can account for an additional 5% to 10% efficiency degradation in portable systems. It is very important to include these *system* level losses during the design phase. The internal battery and fuse resistance losses can be minimized by ensuring that C_{IN} has adequate charge storage and very low ESR at the switching frequency. A 25W supply will typically require a minimum of 20 μ F to 40 μ F of capacitance having a maximum of 20m Ω to 50m Ω of ESR. Other losses including Schottky conduction losses during dead time and inductor core losses generally account for less than 2% total additional loss.

Checking Transient Response

The regulator loop response can be checked by looking at the load current transient response. Switching regulators take several cycles to respond to a step in DC (resistive) load current. When a load step occurs, V_{OUT} shifts by an amount equal to $\Delta I_{LOAD} (ESR)$, where ESR is the effective series resistance of C_{OUT} . ΔI_{LOAD} also begins to charge or discharge C_{OUT} generating the feedback error signal that

forces the regulator to adapt to the current change and return V_{OUT} to its steady-state value. During this recovery time V_{OUT} can be monitored for excessive overshoot or ringing, which would indicate a stability problem. The availability of the I_{TH} pin not only allows optimization of control loop behavior but also provides a DC-coupled and AC-filtered closed-loop response test point. The DC step, rise time and settling at this test point truly reflects the closed-loop response. Assuming a predominantly second order system, phase margin and/or damping factor can be estimated using the percentage of overshoot seen at this pin. The bandwidth can also be estimated by examining the rise time at the pin.

The I_{TH} external components shown in the Typical Application circuit will provide an adequate starting point for most applications. The I_{TH} series R_C - C_C filter sets the dominant pole-zero loop compensation. The values can be modified slightly (from 0.5 to 2 times their suggested values) to optimize transient response once the final PC layout is done and the particular output capacitor type and value have been determined. The output capacitors need to be selected because the various types and values determine the loop gain and phase. An output current pulse of 20% to 80% of full-load current having a rise time of 1 μ s to 10 μ s will produce output voltage and I_{TH} pin waveforms that will give a sense of the overall loop stability without breaking the feedback loop. Placing a power MOSFET directly across the output capacitor and driving the gate with an appropriate signal generator is a practical way to produce a realistic load step condition. The initial output voltage step resulting from the step change in output current may not be within the bandwidth of the feedback loop, so this signal cannot be used to determine phase margin. This is why it is better to look at the I_{TH} pin signal which is in the feedback loop and is the filtered and compensated control loop response. The gain of the loop will be increased by increasing R_C and the bandwidth of the loop will be increased by decreasing C_C . If R_C is increased by the same factor that C_C is decreased, the zero frequency will be kept the same, thereby keeping the phase shift the same in the most critical frequency range of the feedback loop. The output voltage settling behavior is related to the stability of the closed-loop system and will demonstrate the actual overall supply performance.

APPLICATIONS INFORMATION

A second, more severe transient is caused by switching in loads with large ($>1\mu\text{F}$) supply bypass capacitors. The discharged bypass capacitors are effectively put in parallel with C_{OUT} , causing a rapid drop in V_{OUT} . No regulator can alter its delivery of current quickly enough to prevent this sudden step change in output voltage if the load switch resistance is low and it is driven quickly. If the ratio of C_{LOAD} to C_{OUT} is greater than 1:50, the switch rise time should be controlled so that the load rise time is limited to approximately $25 \cdot C_{\text{LOAD}}$. Thus a $10\mu\text{F}$ capacitor would require a $250\mu\text{s}$ rise time, limiting the charging current to about 200mA .

Design Example (Using Two Phases)

As a design example, assume:

$$V_{\text{IN}} = 5\text{V (nominal)}$$

$$V_{\text{IN}} = 5.5\text{V (max)},$$

$$V_{\text{OUT}} = 1.8\text{V},$$

$$I_{\text{MAX}} = 20\text{A}$$

$$T_{\text{A}} = 70^{\circ}\text{C}$$

$$f = 300\text{kHz}$$

The inductance value is chosen first based on a 30% ripple current assumption. The highest value of ripple current occurs at the maximum input voltage. Use a 71.5k resistor from FREQ to ground to set the switching frequency at about 300kHz . The minimum inductance for 30% ripple current is:

$$\begin{aligned} L &\geq \frac{V_{\text{OUT}}}{f(\Delta I)} \left(1 - \frac{V_{\text{OUT}}}{V_{\text{IN}}} \right) \\ &\geq \frac{1.8\text{V}}{(300\text{kHz})(30\%)(10\text{A})} \left(1 - \frac{1.8\text{V}}{5.5\text{V}} \right) \\ &\geq 1.35\mu\text{H} \end{aligned}$$

A $2\mu\text{H}$ inductor will produce 20% ripple current. The peak inductor current will be the maximum DC value plus one half the ripple current, or 11A . The minimum on-time occurs at maximum V_{IN} :

$$t_{\text{ON(MIN)}} = \frac{V_{\text{OUT}}}{V_{\text{IN}}f} = \frac{1.8\text{V}}{(5.5\text{V})(300\text{kHz})} = 1.1\mu\text{s}$$

With the ILIM pin tied to ground, the R_{SENSE} resistors value can be calculated by using the minimum current sense voltage specification with some accommodation for tolerances:

$$R_{\text{SENSE}} = \frac{25\text{mV}}{11\text{A}} \approx 0.002\Omega$$

Choosing 1% resistors: $R_1 = 10\text{k}$ and $R_2 = 20\text{k}$ yields an output voltage of 1.80V .

The power dissipation on the topside MOSFET can be easily estimated. Using a Siliconix Si4420DY for example; $R_{\text{DS(ON)}} = 0.013\Omega$, $C_{\text{RSS}} = 300\text{pF}$. At maximum input voltage with T_{J} (estimated) = 110°C at an elevated ambient temperature:

$$\begin{aligned} P_{\text{MAIN}} &= \frac{1.8\text{V}}{5.5\text{V}} (10)^2 [1 + (0.005)(110^{\circ}\text{C} - 25^{\circ}\text{C})] \\ &\quad \cdot 0.013\Omega + (5.5\text{V})^2 \left(\frac{10\text{A}}{2} \right) (2\Omega) (300\text{pF}) \\ &\quad \left(\frac{1}{5\text{V} - 2.6\text{V}} + \frac{1}{2.6\text{V}} \right) \cdot (300\text{kHz}) \\ &= 0.606 + 0.022 = 0.628\text{W} \end{aligned}$$

The worst-case power dissipated by the synchronous MOSFET under normal operating conditions at elevated ambient temperature and estimated 50°C junction temperature rise is:

$$\begin{aligned} P_{\text{SYNC}} &= \frac{5.5\text{V} - 1.8\text{V}}{5.5\text{V}} (10\text{A})^2 (1.25) (0.013\Omega) \\ &= 1.09\text{W} \end{aligned}$$

APPLICATIONS INFORMATION

A short-circuit to ground will result in a folded back current of:

$$I_{SC} = \frac{25\text{mV}}{0.002\Omega} - \frac{1}{2} \left[\frac{90\text{ns}(5.5\text{V})}{2\mu\text{H}} \right] = 4.04\text{A}$$

The worst-case power dissipated by the synchronous MOSFET under short-circuit conditions at elevated ambient temperature and estimated 50°C junction temperature rise is:

$$P_{\text{SYNC}} = \frac{5.5\text{V} - 1.8\text{V}}{5.5\text{V}} (4.04\text{A})^2 (1.25)(0.013\Omega) \\ = 0.18\text{W}$$

which is much less than normal, full-load conditions. Incidentally, since the load no longer dissipates power in the shorted condition, total system power dissipation is decreased by over 99%.

The duty cycles when the peak RMS input current occurs is at $D = 0.25$ and $D = 0.75$ according to Figure 10. Calculate the worst-case required RMS input current rating at the input voltage, which is 5.5V, that provides a duty cycle nearest to the peak.

From Figure 10, C_{IN} will require an RMS current rating of:

$$C_{IN} \text{ required } I_{\text{RMS}} = (20\text{A})(0.23) \\ = 4.6\text{A}_{\text{RMS}}$$

The output capacitor ripple current is calculated by using the inductor ripple already calculated for each inductor and multiplying by the factor obtained from Figure 8 along with the calculated duty factor. The output ripple in continuous mode will be highest at the maximum input voltage. From Figure 8, the maximum output current ripple is:

$$\Delta I_{\text{COUT}} = \frac{V_{\text{OUT}}}{fL} (0.34) \\ \Delta I_{\text{COUTMAX}} = \frac{1.8(0.34)}{(300\text{kHz})(2\mu\text{H})} = 1\text{A}$$

Note that the PolyPhase technique will have its maximum benefit for input and output ripple currents when the number

of phases times the output voltage is approximately equal to or greater than the input voltage.

PC Board Layout Checklist

When laying out the printed circuit board, the following checklist should be used to ensure proper operation of the IC. These items are also illustrated graphically in the layout diagram of Figure 17. Check the following in the PC layout:

1. Are the signal and power ground paths Kelvin connected? Keep the SGND at one end of a printed circuit path thus preventing MOSFET currents from traveling under the IC. The INTV_{CC} decoupling capacitor should be placed immediately adjacent to the IC between the INTV_{CC} pin and PGND plane. A 1 μF ceramic capacitor of the X7R or X5R type is small enough to fit very close to the IC to minimize the ill effects of the large current pulses drawn to drive the bottom MOSFETs. An additional 5 μF to 10 μF of ceramic, tantalum or other very low ESR capacitance is recommended in order to keep the internal IC supply quiet. The power ground returns to the sources of the bottom N-channel MOSFETs, anodes of the Schottky diodes and (–) plates of C_{IN} , which should have as short lead lengths as possible.
2. Does the IC DIFFP pin connect to the (+) plates of C_{OUT} ? A 30pF to 300pF feedforward capacitor between the DIFFP and V_{FB} pins should be placed as close as possible to the IC.
3. Are the SENSE[–] and SENSE⁺ printed circuit traces for each channel routed together with minimum PC trace spacing? The filter capacitors between SENSE⁺ and SENSE[–] for each channel should be as close as possible to the pins of the IC. Connect the SENSE[–] and SENSE⁺ pins to the pads of the sense resistor as illustrated in Figure 1.
4. Do the (+) plates of C_{PWR} connect to the drains of the topline MOSFETs as closely as possible? This capacitor provides the pulsed current to the MOSFETs.
5. Keep the switching nodes, SWn, BOOSTn and TGN away from sensitive small-signal nodes (SENSE⁺, SENSE[–], DIFFP, DIFFN, V_{FB} , ITEMP). Ideally the SWn, BOOSTn and TGN printed circuit traces should be routed away

APPLICATIONS INFORMATION

and separated from the IC and especially the “quiet” side of the IC. Separate the high dv/dt traces from sensitive small-signal nodes with ground traces or ground planes.

- Use a low impedance source such as a logic gate to drive the PLLIN pin and keep the lead as short as possible.
- The 47pF to 330pF ceramic capacitor between the I_{TH} pin and signal ground should be placed as close as possible to the IC. Figure 17 illustrates all branch currents in a 2-phase switching regulator. It becomes very clear after studying the current waveforms why it is critical to keep the high switching current paths to a small physical size. High electric and magnetic fields will radiate from

these loops just as radio stations transmit signals. The output capacitor ground should return to the negative terminal of the input capacitor and not share a common ground path with any switched current paths. The left half of the circuit gives rise to the *noise* generated by a switching regulator. The ground terminations of the synchronous MOSFETs and Schottky diodes should return to the bottom plate(s) of the input capacitor(s) with a short isolated PC trace since very high switched currents are present. External OPTI-LOOP[®] compensation allows overcompensation for PC layouts which are not optimized, but this is not the recommended design procedure.

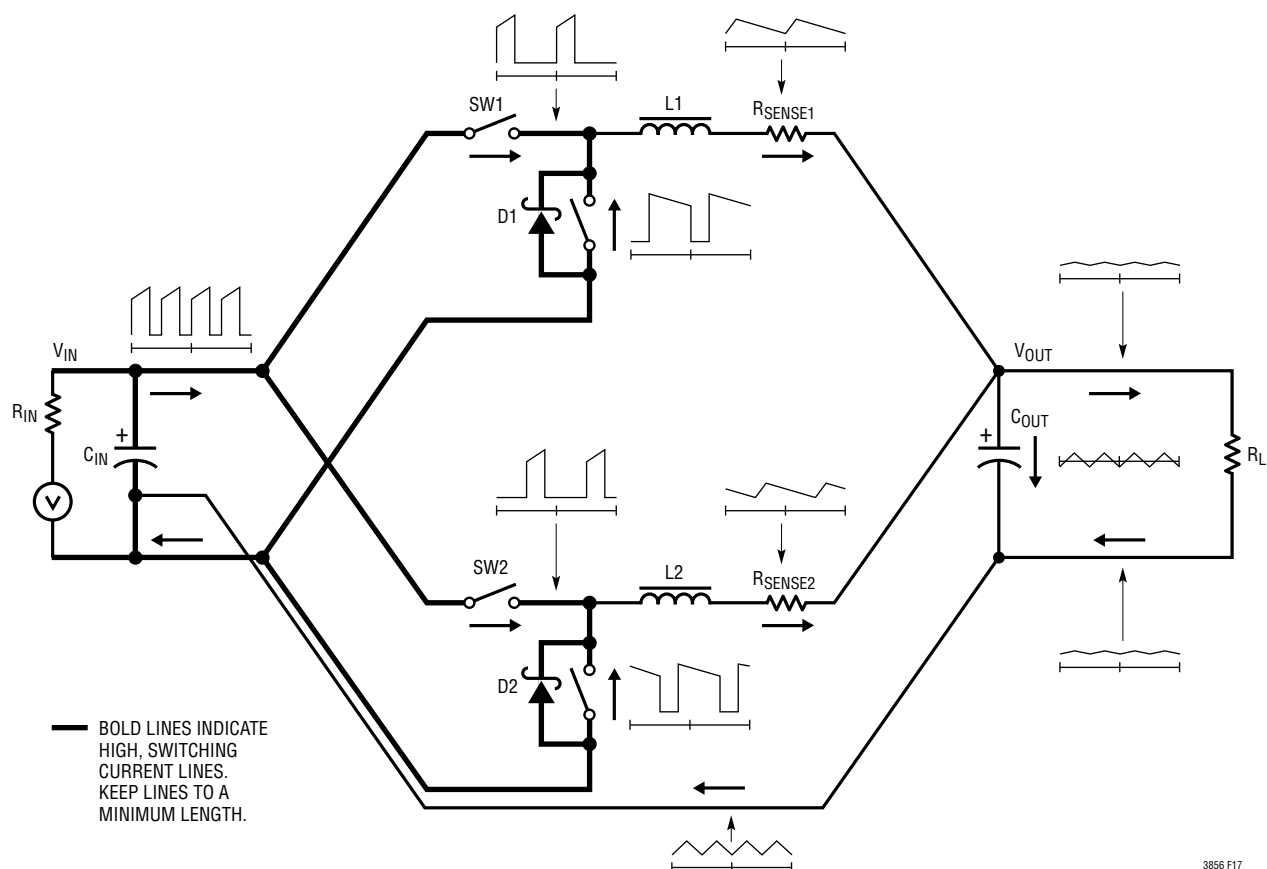
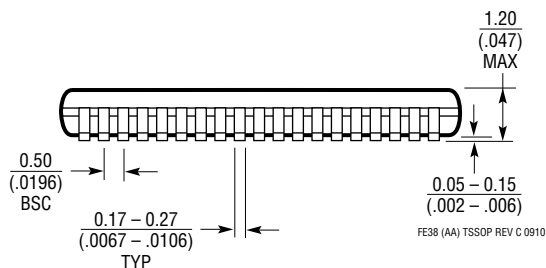
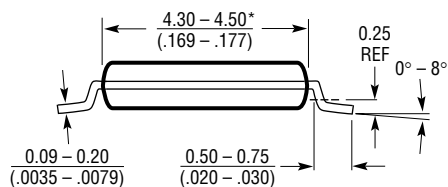
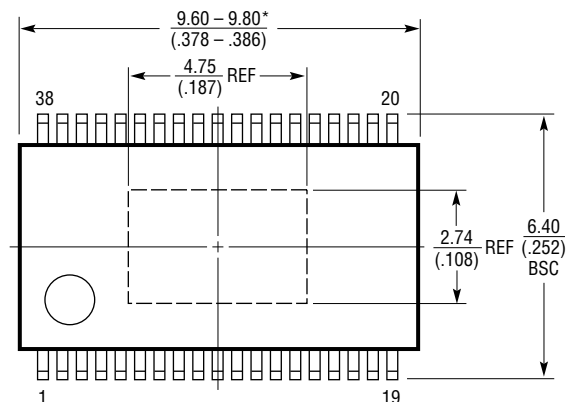
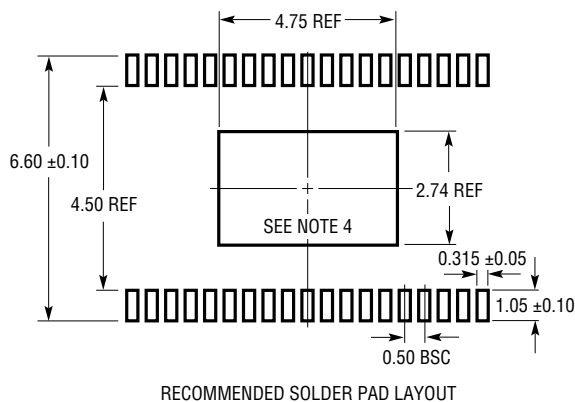

Figure 17. Instantaneous Current Path Flow in a Multiple Phase Switching Regulation

PACKAGE DESCRIPTION

Please refer to <http://www.linear.com/designtools/packaging/> for the most recent package drawings.

FE Package
38-Lead Plastic TSSOP (4.4mm)
 (Reference LTC DWG # 05-08-1772 Rev C)
Exposed Pad Variation AA



- NOTE:
1. CONTROLLING DIMENSION: MILLIMETERS
 2. DIMENSIONS ARE IN $\frac{\text{MILLIMETERS}}{\text{(INCHES)}}$
 3. DRAWING NOT TO SCALE
 4. RECOMMENDED MINIMUM PCB METAL SIZE FOR EXPOSED PAD ATTACHMENT
- *DIMENSIONS DO NOT INCLUDE MOLD FLASH. MOLD FLASH SHALL NOT EXCEED 0.150mm (.006") PER SIDE

PACKAGE DESCRIPTION

Please refer to <http://www.linear.com/designtools/packaging/> for the most recent package drawings.

UH Package
32-Lead Plastic QFN (5mm × 5mm)
 (Reference LTC DWG # 05-08-1693 Rev D)

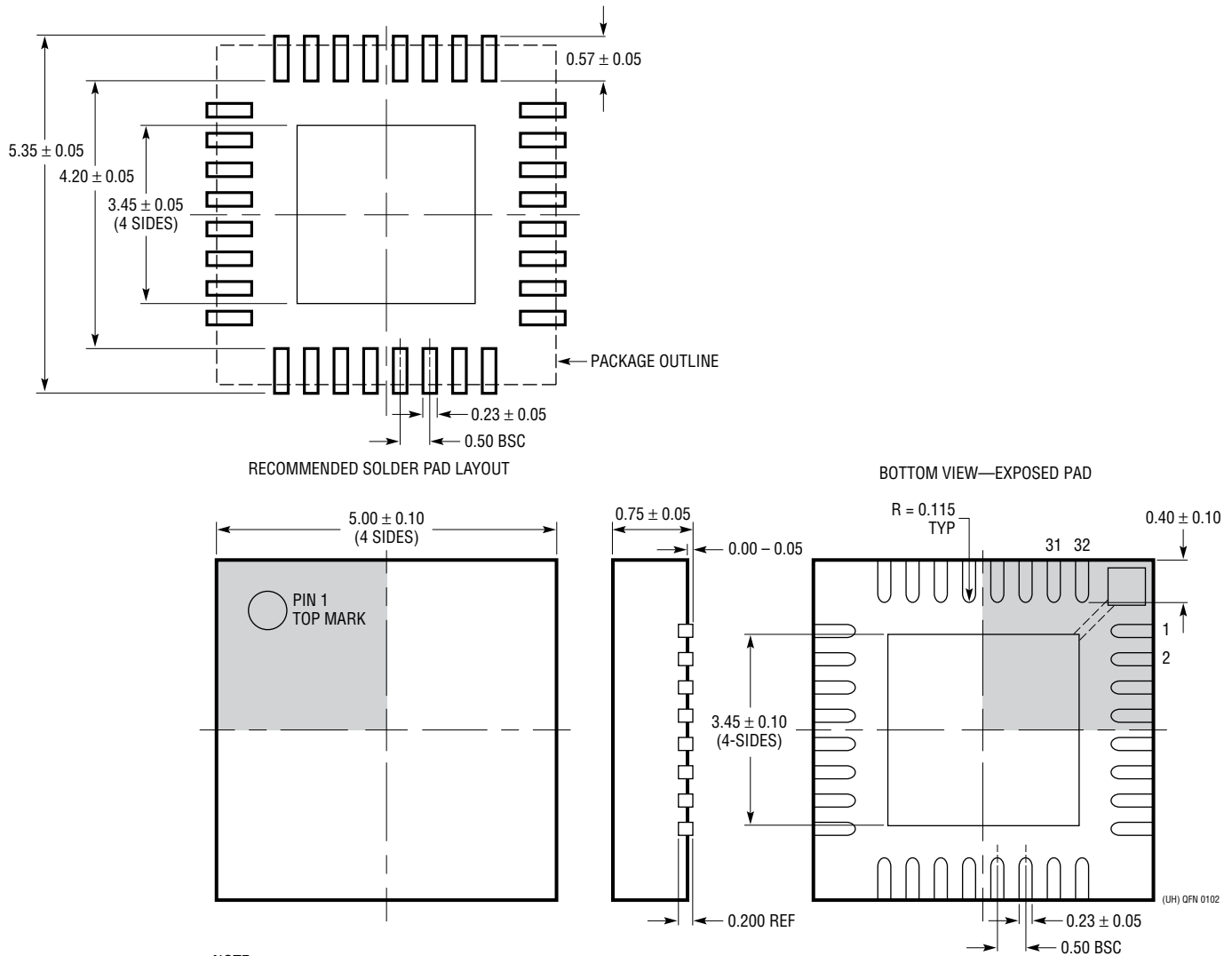

- NOTE:
1. DRAWING PROPOSED TO INCLUDE JEDEC PACKAGE OUTLINE M0-220 VARIATION WHHD-(X) (TO BE APPROVED)
 2. DRAWING NOT TO SCALE
 3. ALL DIMENSIONS ARE IN MILLIMETERS
 4. DIMENSIONS OF EXPOSED PAD ON BOTTOM OF PACKAGE DO NOT INCLUDE MOLD FLASH. MOLD FLASH, IF PRESENT, SHALL NOT EXCEED 0.20mm ON ANY SIDE
 5. EXPOSED PAD SHALL BE SOLDER PLATED

REVISION HISTORY

REV	DATE	DESCRIPTION	PAGE NUMBER
A	06/15	Clarified AVP, DIFFP and SGND pin functions	9, 10
		Changed ΔV_{OUT} equation	24
		Clarified AVP Applications Information	25
		Changed schematic	37

TYPICAL APPLICATION

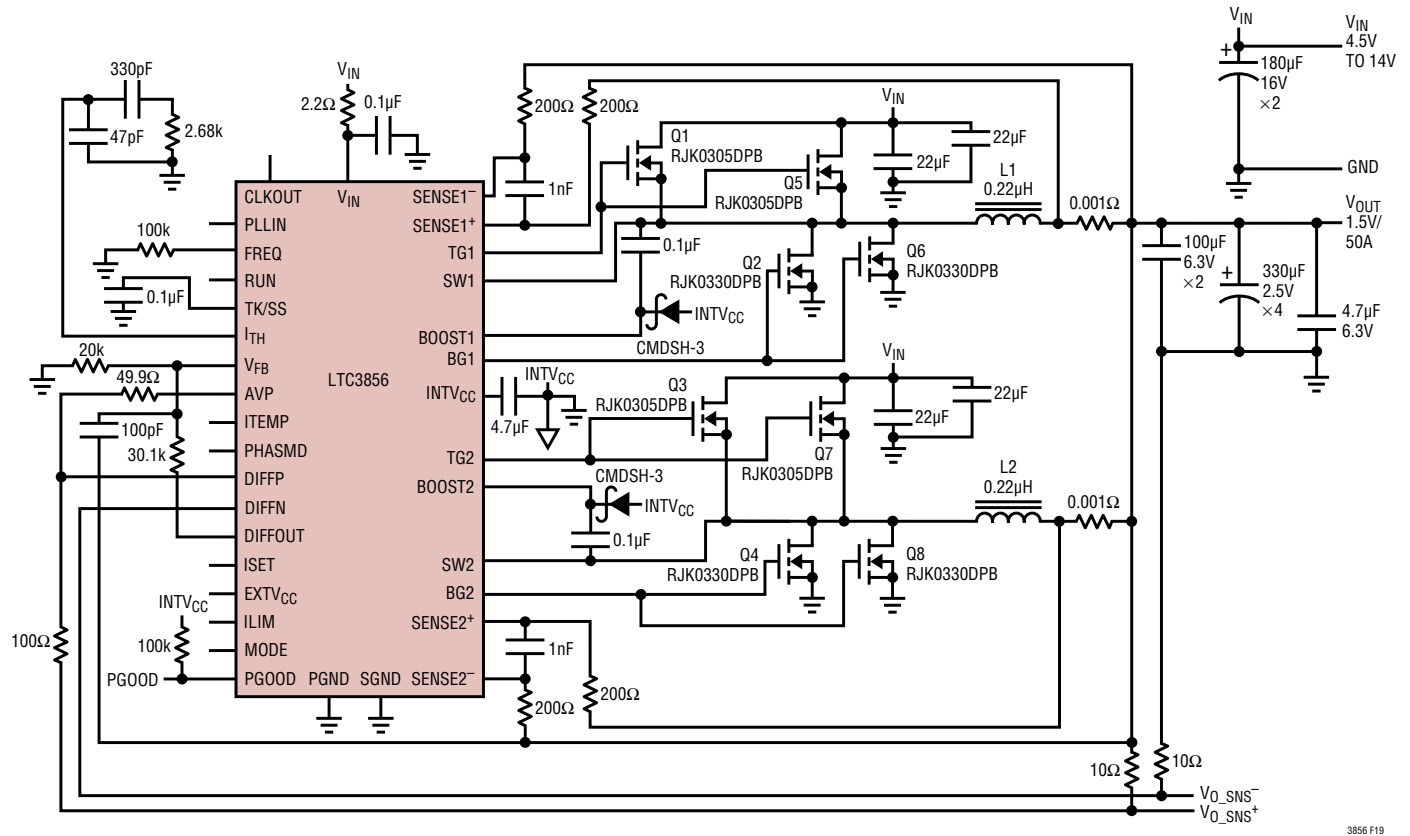

Figure 19. 1.5V/50A Converter with AVP

RELATED PARTS

PART NUMBER	DESCRIPTION	COMMENTS
LTC3839	Single Output, 2-Phase, Synchronous Step-Down DC/DC Controller with Diff Amp and Controlled On-Time	$4.5V \leq V_{IN} \leq 38V$, $0.8V \leq V_{OUT} \leq 5.5V$ PLL, Up to 2MHz Switching Frequency
LTC3829	3-Phase, Single Output, Synchronous Step-Down Controller with Diff Amp and DCR Temperature Compensation	Phase-Lockable Fixed 250kHz to 770kHz Frequency, $4.5V \leq V_{IN} \leq 38V$, $0.8V \leq V_{OUT} \leq 5V$
LTC3861	Dual, Multiphase, Synchronous Step-Down DC/DC Controller with Diff Amp and Three-State Output Drive	Operates with Power Blocks, DrMOS Devices or External MOSFETs $3V \leq V_{IN} \leq 24V$, $t_{ON(MIN)} = 20ns$
LTC3855	Dual, Multiphase, Synchronous Step-Down DC/DC Controller with Diff Amp and DCR Temperature Compensation	Phase-Lockable Fixed Frequency 250kHz to 770kHz, $4.5V \leq V_{IN} \leq 38V$, $0.8V \leq V_{OUT} \leq 12V$
LTC3853	Triple Output, Multiphase, Synchronous Step-Down DC/DC Controller, R_{SENSE} or DCR Current Sensing and Tracking	Phase-Lockable Fixed 250kHz to 750kHz Frequency, $4V \leq V_{IN} \leq 24V$, V_{OUT3} , Up to 13.5V
LTC3869/LTC3869-2	Dual Output, 2-Phase, Synchronous Step-Down DC/DC Controller with Accurate Current Share	$4V \leq V_{IN} \leq 38V$, V_{OUT3} Up to 12.5V PLL Fixed 250kHz to 750kHz Frequency
LTC3887	Dual Output, PolyPhase Step-Down DC/DC Controller with Digital Power System Management	V_{IN} Up to 24V, $0.5V \leq V_{OUT} \leq 5.5V$, Analog Control Loop, I ² C/PMBus Interface with EEPROM and 16-Bit ADC

X-ON Electronics

Largest Supplier of Electrical and Electronic Components

Click to view similar products for [Switching Voltage Regulators](#) category:

Click to view products by [Analog Devices](#) manufacturer:

Other Similar products are found below :

[FAN53610AUC33X](#) [FAN53611AUC123X](#) [FAN48610BUC33X](#) [FAN48610BUC45X](#) [FAN48617UC50X](#) [R3](#) [430464BB](#) [KE177614](#)
[FAN53611AUC12X](#) [MAX809TTR](#) [NCV891234MW50R2G](#) [NCP81103MNTXG](#) [NCP81203PMNTXG](#) [NCP81208MNTXG](#)
[NCP81109GMNTXG](#) [SCY1751FCCT1G](#) [NCP81109JMNTXG](#) [AP3409ADNTR-G1](#) [NCP81241MNTXG](#) [LTM8064IY](#) [LT8315EFE#TRPBF](#)
[LTM4664EY#PBF](#) [LTM4668AIY#PBF](#) [NCV1077CSTBT3G](#) [XCL207A123CR-G](#) [MPM54304GMN-0002](#) [MPM54304GMN-0004](#)
[MPM54304GMN-0003](#) [AP62300Z6-7](#) [MP8757GL-P](#) [MIC23356YFT-TR](#) [LD8116CGL](#) [HG2269M/TR](#) [OB2269](#) [XD3526](#) [U6215A](#) [U6215B](#)
[U6620S](#) [LTC3412IFE](#) [LT1425IS](#) [MAX25203BATJA/VY+](#) [MAX77874CEWM+](#) [XC9236D08CER-G](#) [MP3416GJ-P](#) [MP5461GC-Z](#)
[MPQ4415AGQB-Z](#) [MPQ4590GS-Z](#) [MAX38640BENT18+T](#) [MAX77511AEWB+](#) [MAX20406AFOD/VY+](#)