

Linear Li-Ion Battery Charger with Thermal Regulation in ThinSOT

FEATURES

- Programmable Charge Current up to 800mA
- No External MOSFET, Sense Resistor or Blocking Diode Required
- Constant-Current/Constant-Voltage Operation with Thermal Regulation Maximizes Charge Rate Without Risk of Overheating*
- Charges Single Cell Li-Ion Batteries Directly from USB Port
- Preset 4.2V Charge Voltage with $\pm 1\%$ Accuracy
- Current Monitor Pin for Charge Termination
- 25 μ A Supply Current in Shutdown Mode
- Low Battery Charge Conditioning (Trickle Charging)
- Soft-Start Limits Inrush Current
- Available in a Low Profile (1mm) SOT-23 Package

APPLICATIONS

- Wireless PDAs
- Cellular Phones
- Portable Electronics

LT, LTC and LT are registered trademarks of Linear Technology Corporation.
ThinSOT is a trademark of Linear Technology Corporation.
*U.S. Patent No. 6522118

DESCRIPTION

The LTC[®]4057 is a constant-current/constant-voltage linear charger for single-cell lithium-ion batteries. Its ThinSOT[™] package and low external component count make the LTC4057 especially well suited for portable applications. Furthermore, the LTC4057 is specifically designed to work within USB power specifications.

No external sense resistor is needed and no blocking diode is required due to the internal MOSFET architecture. Thermal feedback prevents overheating by regulating the charge current to limit the die temperature during high power operation or high ambient temperature conditions. The charge voltage is preset at 4.2V and the charge current can be programmed externally with a single resistor.

When the input supply (wall adapter or USB supply) is removed, the LTC4057 automatically enters a low current state, dropping the battery drain current to less than 2 μ A. With power applied, the LTC4057 can be put into shutdown mode, reducing the supply current to 25 μ A.

For the standalone version (on-board charge termination) of the LTC4057, refer to the LTC4054.

TYPICAL APPLICATION

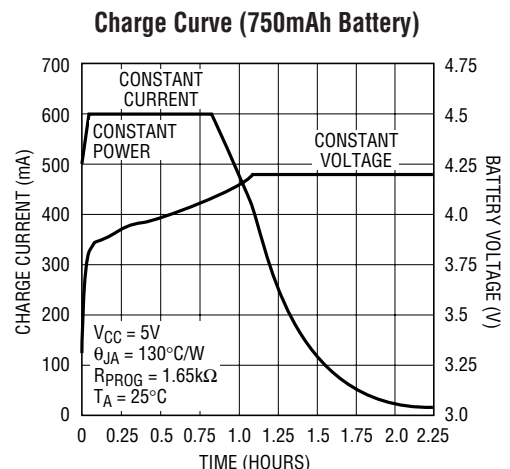
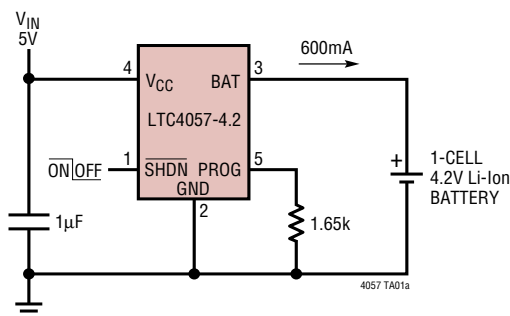

ABSOLUTE MAXIMUM RATINGS

(Note 1)

Input Supply Voltage (V_{CC})	-0.3V to 10V
PROG	-0.3V to $V_{CC} + 0.3V$
BAT	-0.3V to 7V
SHDN	-0.3V to 10V
BAT Short Circuit Duration	Continuous
BAT Pin Current	800mA
PROG Pin Current	800 μ A
Junction Temperature	125°C
Operating Ambient Temperature Range	
(Note 2)	-40°C to 85°C
Storage Temperature Range	-65°C to 125°C
Lead Temperature (Soldering, 10 sec)	300°C

PACKAGE/ORDER INFORMATION

<p>TOP VIEW</p> <p>SHDN 1 5 PROG</p> <p>GND 2 4 VCC</p> <p>BAT 3</p> <p>S5 PACKAGE 5-LEAD PLASTIC SOT-23</p> <p>$T_{JMAX} = 125^{\circ}C$, ($\theta_{JA} = 100^{\circ}C/W$ TO $150^{\circ}C/W$ DEPENDENT ON PC BOARD LAYOUT) (NOTE 3)</p>	ORDER PART NUMBER
	LTC4057ES5-4.2
	S5 PART MARKING
	LTAEW

Consult LTC Marketing for parts specified with wider operating temperature ranges.

ELECTRICAL CHARACTERISTICS

The ● denotes the specifications which apply over the full operating temperature range, otherwise specifications are at $T_A = 25^{\circ}C$. $V_{CC} = 5V$

SYMBOL	PARAMETER	CONDITIONS	MIN	TYP	MAX	UNITS	
V_{CC}	Input Supply Voltage		● 4.25		6.5	V	
I_{CC}	Input Supply Current	$I_{BAT} = 0mA$, $R_{PROG} = 2k$ Shutdown Mode (SHDN = 0V, $V_{CC} < V_{BAT}$, or $V_{CC} < V_{UV}$)	●	200	600	μ A	
V_{FLOAT}	Regulated Output (Float) Voltage	$I_{BAT} = 40mA$, $0^{\circ}C < T_A < 85^{\circ}C$		4.158	4.2	4.242	V
I_{BAT}	BAT Pin Charge Current	$R_{PROG} = 10k$; Current Mode $R_{PROG} = 2k$; Current Mode Shutdown Mode (SHDN = 0V) Sleep Mode ($V_{CC} = 0V$)	●	93	100	107	mA
			●	465	500	535	mA
					± 1	± 2	μ A
					± 1	± 2	μ A
I_{TRIKL}	Trickle Charge Current	$V_{BAT} < 2.9V$; $R_{PROG} = 2k$ ($I_{CHG} = 500mA$)	●	20	50	70	mA
V_{TRIKL}	Trickle Charge Threshold Voltage	$R_{PROG} = 10k$; V_{BAT} Rising Hysteresis		2.8	2.9	3.0	V
				60	80	110	mV
V_{UV}	V_{CC} Undervoltage Lockout Voltage	From Low to High Hysteresis	●	3.7	3.8	3.9	V
			●	150	200	300	mV
V_{ASD}	$V_{CC} - V_{BAT}$ Lockout Threshold Voltage	V_{CC} from Low to High V_{CC} from High to Low		70	100	150	mV
				5	30	70	mV
V_{PROG}	PROG Pin Voltage	$R_{PROG} = 10k$; Current Mode	●	0.93	1.0	1.07	V
$V_{SHDN-IL}$	SHDN Pin Input Low Voltage			0.4	0.65		V
$V_{SHDN-IH}$	SHDN Pin Input High Voltage				0.65	1.0	V
I_{SHDN}	SHDN Pin Input Current	$V_{SHDN} = 5V$	●		5	15	μ A
T_{LIM}	Junction Temperature in Constant-Temperature Mode				120		$^{\circ}C$
R_{ON}	Power FET "ON" Resistance (Between V_{CC} and BAT)				600		m Ω
t_{SS}	Soft-Start Time	$I_{BAT} = 0$ to $I_{BAT} = 1000V/R_{PROG}$			100		μ s

ELECTRICAL CHARACTERISTICS

Note 1: Absolute Maximum Ratings are those values beyond which the life of a device may be impaired.

Note 2: The LTC4057 is guaranteed to meet performance specifications from 0°C to 70°C. Specifications over the -40°C to 85°C operating temperature

range are assured by design, characterization and correlation with statistical process controls.

Note 3: See Thermal Considerations.

TYPICAL PERFORMANCE CHARACTERISTICS

PROG Pin Voltage vs Supply Voltage (Constant Current Mode)

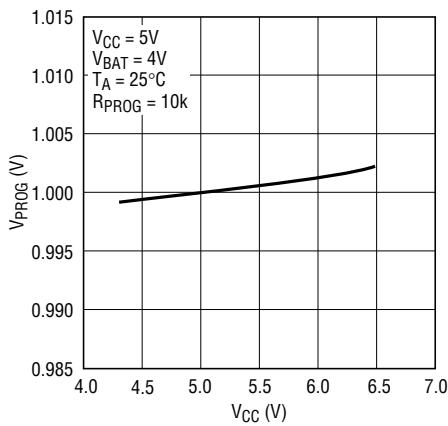

4057 G01

PROG Pin Voltage vs Temperature (Constant Current Mode)

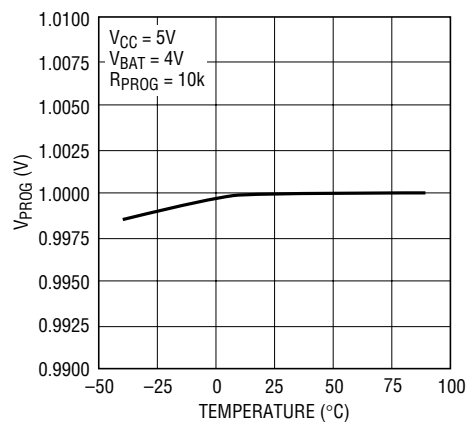

4057 G02

Charge Current vs PROG Pin Voltage

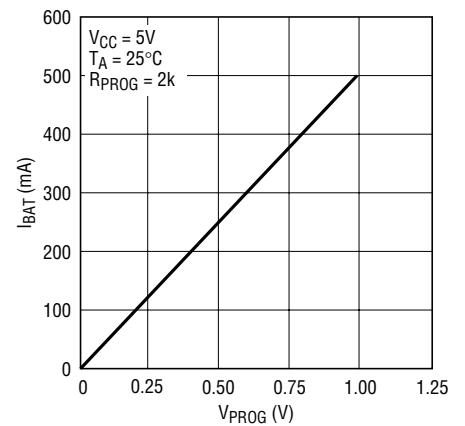

4057 G03

Regulated Output (Float) Voltage vs Charge Current

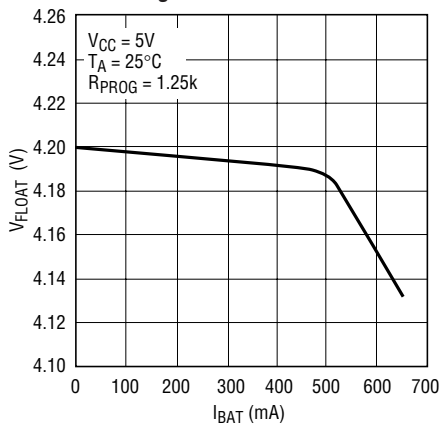

4057 G04

Regulated Output (Float) Voltage vs Temperature

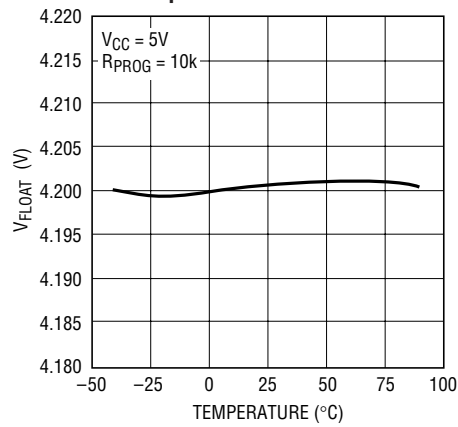

4057 G05

Regulated Output (Float) Voltage vs Supply Voltage

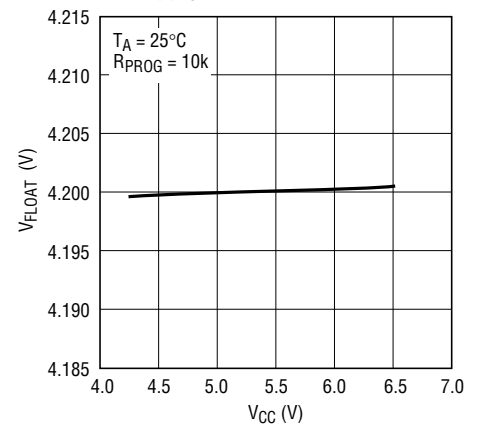

4057 G06

TYPICAL PERFORMANCE CHARACTERISTICS

SHDN Threshold Voltage vs Temperature and Supply Voltage

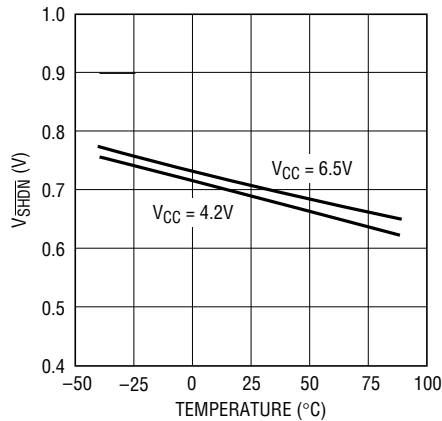

4057 G07

Trickle Charge Current vs Temperature

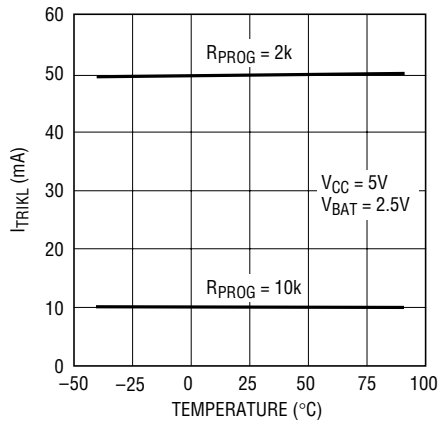

4057 G08

Trickle Charge Current vs Supply Voltage

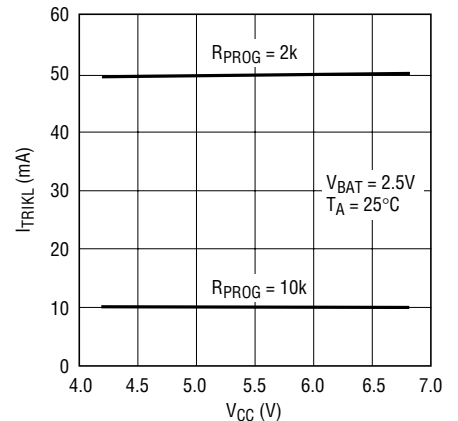

4057 G09

Trickle Charge Threshold vs Temperature

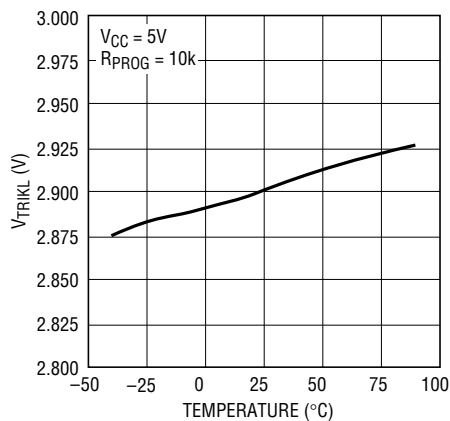

4057 G10

Charge Current vs Battery Voltage

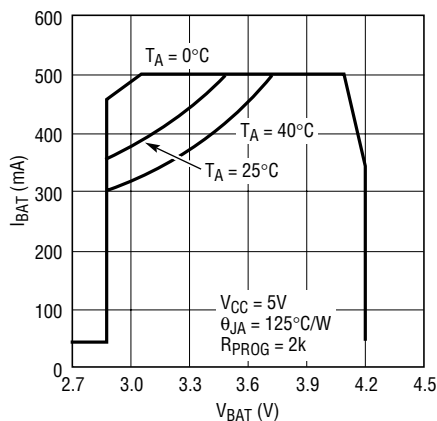

4057 G11

Charge Current vs Supply Voltage

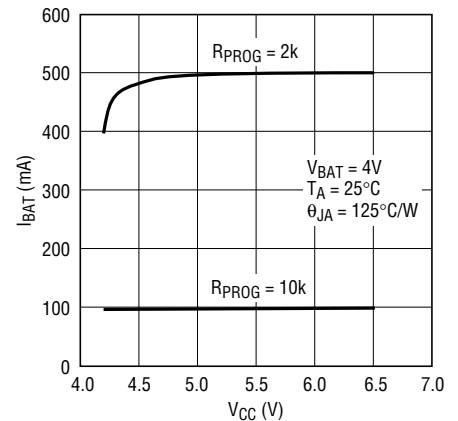

4057 G12

Charge Current vs Ambient Temperature

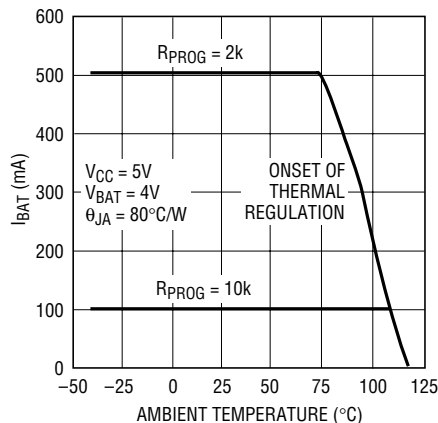

4057 G13

Power FET "ON" Resistance vs Temperature

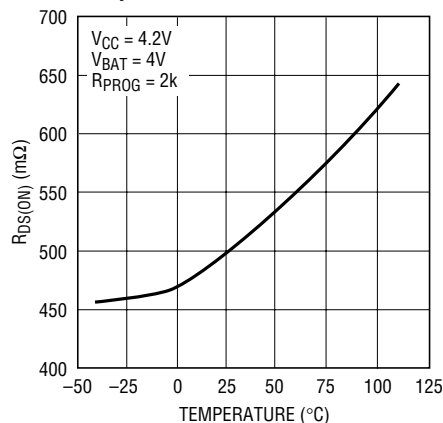

4057 G14

OPERATION

The LTC4057 is a single-cell lithium-ion battery charger using a constant-current/constant-voltage algorithm. It can deliver up to 800mA of charge current (using a good thermal PC board layout) with a final float voltage accuracy of $\pm 1\%$. The LTC4057 includes an internal P-channel power MOSFET and thermal regulation circuitry. No blocking diode or external current sense resistor is required and the LTC4057 is capable of operating from a USB power source.

Normal Charge

Charging begins when $\overline{\text{SHDN}}$ is high, the voltage at the V_{CC} pin rises above the UVLO threshold level and a program resistor is connected from the PROG pin to ground. If the BAT pin voltage is below 2.9V, the charger enters trickle-charge mode. In this mode, the LTC4057 supplies approximately 1/10 the programmed charge current to bring the battery voltage up to a safe level for full current charging.

When the BAT pin voltage rises above 2.9V, the charger enters constant-current mode, where the programmed charge current is supplied to the battery. When the BAT pin approaches the final float voltage (4.2V), the LTC4057 enters constant-voltage mode, and the charge current begins to decrease.

Programming Charge Current

The charge current is programmed using a single resistor from the PROG pin to ground. The charge current is 1000 times the current out of the PROG pin. The program resistor and the charge current are calculated using the following equations:

$$R_{\text{PROG}} = \frac{1000V}{I_{\text{CHG}}}, I_{\text{CHG}} = \frac{1000V}{R_{\text{PROG}}}$$

The charge current out of the BAT pin can be determined at any time by monitoring the PROG pin voltage and using the following equation:

$$I_{\text{BAT}} = \frac{V_{\text{PROG}}}{R_{\text{PROG}}} \cdot 1000$$

Thermal Limiting

An internal thermal feedback loop reduces the programmed charge current if the die temperature attempts to rise above a preset value of approximately 120°C. This feature protects the LTC4057 from excessive temperature and allows the user to push the limits of the power handling capability of a given circuit board without risk of damaging the LTC4057. The charge current can be set according to typical (not worst-case) ambient temperature with the assurance that the charger will automatically reduce the current in worst-case conditions. ThinSOT power considerations are discussed further in the Applications Information section.

Undervoltage Lockout (UVLO)

An internal undervoltage lockout circuit monitors the input voltage and keeps the charger in shutdown mode until V_{CC} rises above the undervoltage lockout threshold. The UVLO circuit has a built-in hysteresis of 200mV. Furthermore, to protect against reverse current in the power MOSFET, the UVLO circuit keeps the charger in shutdown mode if V_{CC} falls to within 30mV of the battery voltage. If the UVLO comparator is tripped, the charger will not come out of shutdown mode until V_{CC} rises 100mV above the battery voltage.

Shutdown Mode

The LTC4057 can also be put into shutdown mode at any time by applying logic “low” to the SHDN pin ($V_{\overline{\text{SHDN}}} < 0.4V$). This reduces the battery drain current to less than 2 μA and the input supply current to less than 50 μA . Charging will resume when applying a logic “high” to the $\overline{\text{SHDN}}$ pin ($V_{\overline{\text{SHDN}}} > 1V$).

APPLICATIONS INFORMATION

Stability Considerations

The constant-voltage mode feedback loop is stable without an output capacitor provided a battery is connected to the charge output. When an output capacitor is used, especially high value low ESR ceramic types, it is recommended that a 1Ω resistor be placed in series with the capacitor to stabilize the voltage loop. The loop stability is determined by the bypass capacitor as well as the effective series resistance of the battery.

When the battery is disconnected and the LTC4057 is still powered, the voltage regulation loop should be compensated by placing a capacitor greater than $1\mu\text{F}$ from the BAT pin to ground with a 1Ω to 2Ω resistor in series with this capacitor. Alternatively, powering down the LTC4057 or placing it into shutdown mode when the battery is disconnected avoids this problem.

In constant-current mode, the PROG pin is in the feedback loop, not the battery. The constant-current mode stability is affected by the impedance at the PROG pin. With no additional capacitance on the PROG pin, the charger is stable with program resistor values as high as 20k . However, additional capacitance on this node reduces the maximum allowed program resistor value. The pole frequency at the PROG pin should be kept above 100kHz . Therefore, if the PROG pin is loaded with a capacitance, C_{PROG} , the following equation can be used to calculate the maximum resistance value for R_{PROG} :

$$R_{\text{PROG}} \leq \frac{1}{2\pi \cdot 10^5 \cdot C_{\text{PROG}}}$$

Average, rather than instantaneous, battery current may be of interest to the user. For example, if a switching power supply operating in low-current mode is connected in parallel with the battery, the average current being pulled out of the BAT pin is typically of more interest than the instantaneous current pulses. In such a case, a simple RC filter can be used on the PROG pin to measure the average battery current as shown in Figure 1. A 10k resistor has been added between the PROG pin and the filter capacitor to ensure stability.

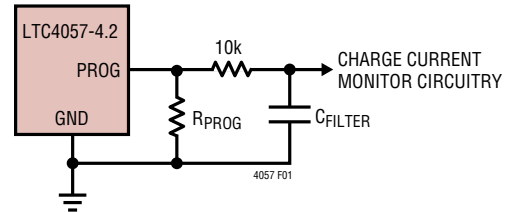

Figure 1. Isolating Capacitive Load on PROG Pin and Filtering

Power Dissipation

The conditions that cause the LTC4057 to reduce charge current through thermal feedback can be approximated by considering the power dissipated in the IC. Nearly all of this power dissipation is generated by the internal MOSFET. This is calculated to be approximately:

$$P_D = (V_{\text{CC}} - V_{\text{BAT}}) \cdot I_{\text{BAT}}$$

where P_D is the power dissipated, V_{CC} is the input supply voltage, V_{BAT} is the battery voltage, and I_{BAT} is the charge current. The approximate ambient temperature at which the thermal feedback begins to protect the IC is:

$$T_A = 120^\circ\text{C} - P_D \theta_{\text{JA}}$$

$$T_A = 120^\circ\text{C} - (V_{\text{CC}} - V_{\text{BAT}}) \cdot I_{\text{BAT}} \cdot \theta_{\text{JA}}$$

Example: An LTC4057 operating from a 4.5V USB supply is programmed to supply 600mA full-scale current to a discharged Li-Ion battery with a voltage of 3.7V . Assuming θ_{JA} is $150^\circ\text{C}/\text{W}$ (see Board Layout Considerations), the ambient temperature at which the LTC4057 will begin to reduce the charge current is approximately:

$$T_A = 120^\circ\text{C} - (4.5\text{V} - 3.7\text{V}) \cdot (600\text{mA}) \cdot 150^\circ\text{C}/\text{W}$$

$$T_A = 120^\circ\text{C} - 0.48\text{W} \cdot 150^\circ\text{C}/\text{W} = 120^\circ\text{C} - 72^\circ\text{C}$$

$$T_A = 48^\circ\text{C}$$

The LTC4057 can be used above 48°C ambient, but the charge current will be reduced from 600mA . The approximate current at a given ambient temperature can be approximated by:

$$I_{\text{BAT}} = \frac{120^\circ\text{C} - T_A}{(V_{\text{CC}} - V_{\text{BAT}}) \cdot \theta_{\text{JA}}}$$

APPLICATIONS INFORMATION

Using the previous example with an ambient temperature of 60°C, the charge current will be reduced to approximately:

$$I_{BAT} = \frac{120^{\circ}\text{C} - 60^{\circ}\text{C}}{(4.5\text{V} - 3.7\text{V}) \cdot 150^{\circ}\text{C} / \text{W}} = \frac{60^{\circ}\text{C}}{120^{\circ}\text{C} / \text{A}}$$

$$I_{BAT} = 500\text{mA}$$

Moreover, when thermal feedback reduces the charge current, the voltage at the PROG pin is also reduced proportionally as discussed in the Operation section.

It is important to remember that LTC4057 applications do not need to be designed for worst-case thermal conditions since the IC will automatically reduce power dissipation when the junction temperature reaches approximately 120°C.

Thermal Considerations

Because of the small size of the ThinSOT package, it is very important to use a good thermal PC board layout to maximize the available charge current. The thermal path for the heat generated by the IC is from the die to the copper lead frame, through the package leads, (especially the ground lead) to the PC board copper. The PC board copper is the heat sink. The footprint copper pads should be as wide as possible and expand out to larger copper areas to spread and dissipate the heat to the surrounding ambient. Feedthrough vias to inner or backside copper layers are also useful in improving the overall thermal performance of the charger. Other heat sources on the board, not related to the charger, must also be considered when designing a PC board layout because they will affect overall temperature rise and the maximum charge current.

Table 1 lists thermal resistance for several different board sizes and copper areas. All measurements were taken in still air on 3/32" FR-4 board with one ounce copper.

Table 1. Measured Thermal Resistance

COPPER AREA		BOARD AREA	THERMAL RESISTANCE
TOPSIDE*	BACKSIDE		JUNCTION-TO-AMBIENT
2500mm ²	2500mm ²	2500mm ²	125°C/W
1000mm ²	2500mm ²	2500mm ²	125°C/W
225mm ²	2500mm ²	2500mm ²	130°C/W
100mm ²	2500mm ²	2500mm ²	135°C/W
50mm ²	2500mm ²	2500mm ²	150°C/W

*Device is mounted on topside.

Increasing Thermal Regulation Current

Reducing the voltage drop across the internal MOSFET can significantly decrease the power dissipation in the IC. This has the effect of increasing the current delivered to the battery during thermal regulation. One method is by dissipating some of the power through an external component, such as a resistor or diode.

Example: An LTC4057-4.2 operating from a 5V wall adapter is programmed to supply 800mA full-scale current to a discharged Li-Ion battery with a voltage of 3.75V. Assuming θ_{JA} is 125°C/W, the approximate charge current at an ambient temperature of 25°C is:

$$I_{BAT} = \frac{120^{\circ}\text{C} - 25^{\circ}\text{C}}{(5\text{V} - 3.75\text{V}) \cdot 125^{\circ}\text{C} / \text{W}} = 608\text{mA}$$

By dropping voltage across a resistor in series with a 5V wall adapter (shown in Figure 2), the on-chip power dissipation can be decreased, thus increasing the thermally regulated charge current.

$$I_{BAT} = \frac{120^{\circ}\text{C} - 25^{\circ}\text{C}}{(V_S - I_{BAT}R_{CC} - V_{BAT}) \cdot \theta_{JA}}$$

APPLICATIONS INFORMATION

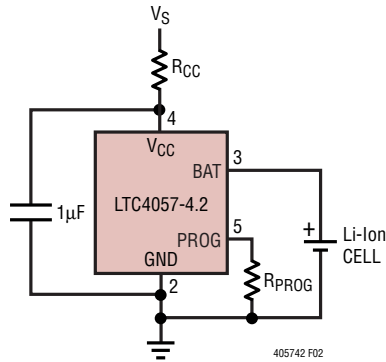

Figure 2. A Circuit to Maximize Thermal Mode Charge Current

Solving for I_{BAT} using the quadratic formula¹.

$$I_{BAT} = \frac{(V_S - V_{BAT}) - \sqrt{(V_S - V_{BAT})^2 - \frac{4R_{CC}(120^\circ\text{C} - T_A)}{\theta_{JA}}}}{2R_{CC}}$$

Using $R_{CC} = 0.25\Omega$, $V_S = 5\text{V}$, $V_{BAT} = 3.75\text{V}$, $T_A = 25^\circ\text{C}$ and $\theta_{JA} = 125^\circ\text{C/W}$, we can calculate the thermally regulated charge current to be:

$$I_{BAT} = 708.4\text{mA}$$

While this application delivers more energy to the battery and reduces charge time in thermal mode, it may actually lengthen charge time in voltage mode if V_{CC} becomes low enough to put the LTC4057 into dropout. Figure 3 shows how this circuit can result in dropout as R_{CC} becomes large.

This technique works best when R_{CC} values are minimized to keep component size small and avoid dropout. Remember to choose a resistor with adequate power handling capability.

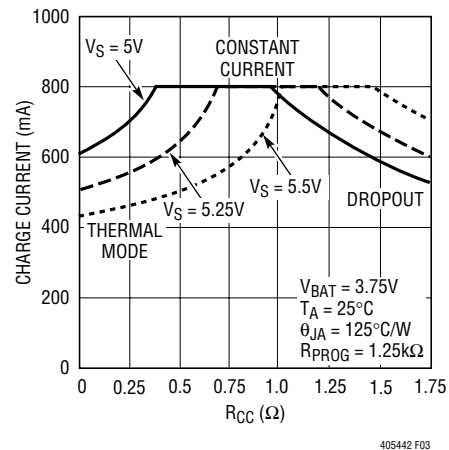

Figure 3. Charge Current vs R_{CC}

Note 1: Large values of R_{CC} will result in no solution for I_{BAT} . This indicates that the LTC4057 will not generate enough heat to require thermal regulation.

APPLICATIONS INFORMATION

V_{CC} Bypass Capacitor

Many types of capacitors can be used for input bypassing; however, caution must be exercised when using multi-layer ceramic capacitors. Because of the self resonant and high Q characteristics of some types of ceramic capacitors, high voltage transients can be generated under some start-up conditions, such as connecting the charger input to a live power source. Adding a 1.5Ω resistor in series with an X5R ceramic capacitor will minimize start-up voltage transients. For more information, refer to Application Note 88.

Charge Current Soft-Start

The LTC4057 includes a soft-start circuit to minimize the inrush current at the start of a charge cycle. When charging begins, the charge current ramps from zero to the full-scale current over a period of approximately 100μs. This has the effect of minimizing the transient current load on the power supply during startup.

PACKAGE DESCRIPTION

S5 Package
5-Lead Plastic TSOT-23
 (Reference LTC DWG # 05-08-1635)

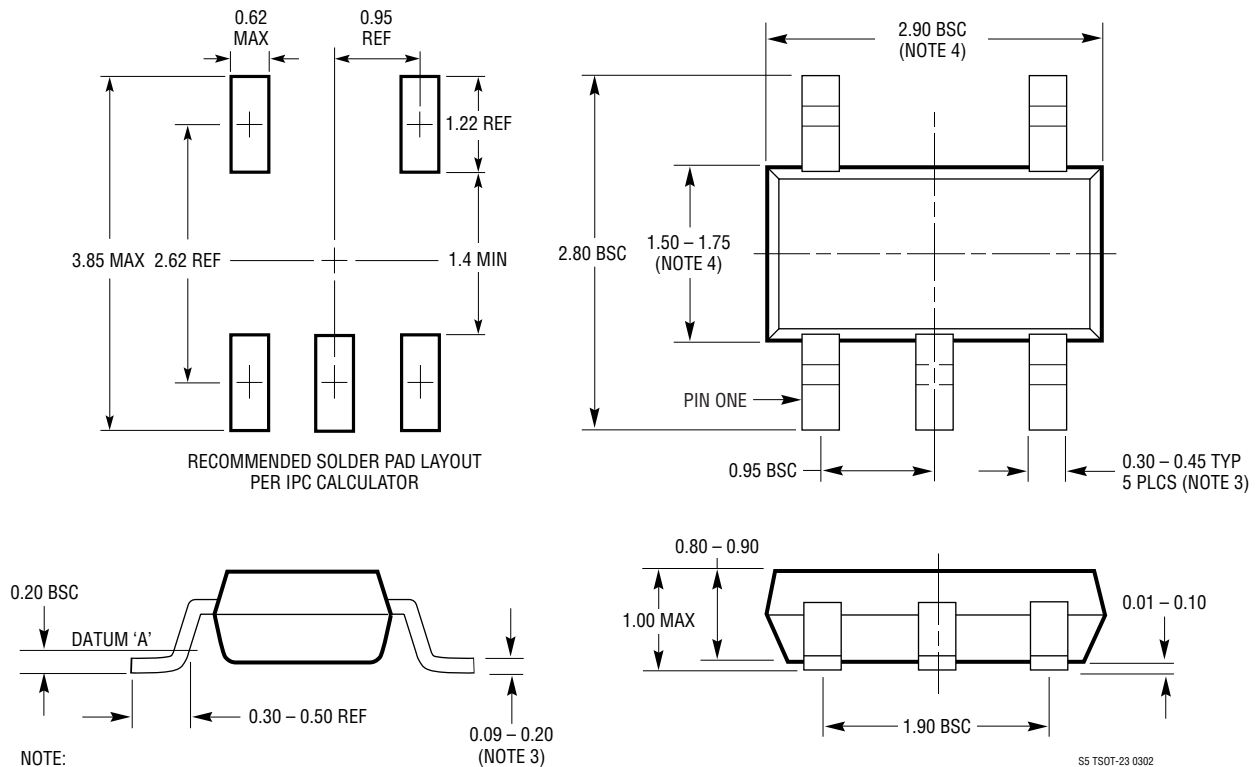

NOTE:

1. DIMENSIONS ARE IN MILLIMETERS
2. DRAWING NOT TO SCALE
3. DIMENSIONS ARE INCLUSIVE OF PLATING
4. DIMENSIONS ARE EXCLUSIVE OF MOLD FLASH AND METAL BURR
5. MOLD FLASH SHALL NOT EXCEED 0.254mm
6. JEDEC PACKAGE REFERENCE IS MO-193

TYPICAL APPLICATIONS

800mA Li-Ion Charger with External Power Dissipation

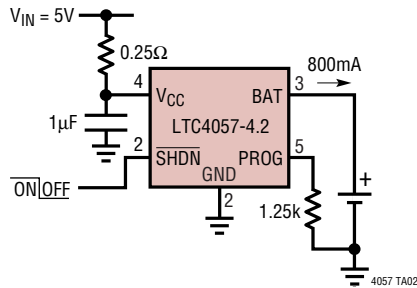

Basic Li-Ion Battery Charger with Reverse Polarity Input Protection

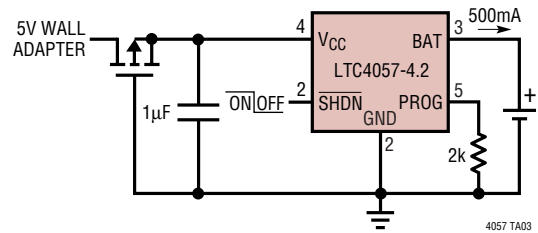

RELATED PARTS

PART NUMBER	DESCRIPTION	COMMENTS
LT1571	200kHz/500kHz Switching Battery Charger	Up to 1.5A Charge Current; Preset and Adjustable Battery Voltages
LTC1729	Lithium-Ion Battery Charger Termination Controllers	Time or Charge Current Termination, Preconditioning 8-Lead MSOP
LTC1730	Lithium-Ion Battery Pulse Charger	No Blocking Diode Required, Current Limit for Maximum Safety
LTC1731	Lithium-Ion Linear Battery Charger Controller	Simple Charger uses External FET, Features Preset Voltages, C/10 Charger Detection and Programmable Timer
LTC1732	Lithium-Ion Linear Battery Charger Controller	Simple Charger uses External FET, Features Preset Voltages, C/10 Charger Detection and Programmable Timer, Input Power Good Indication
LTC1733	Monolithic Lithium-Ion Linear Battery Charger	Standalone Charger with Programmable Timer, Up to 1.5A Charge Current
LTC1734	Lithium-Ion Linear Battery Charger in ThinSOT	Simple ThinSOT Charger, No Blocking Diode, No Sense Resistor Needed
LTC1734L	Lithium-Ion Linear Battery Charger in ThinSOT	Low Charge Current Version of LTC1734
LTC1998	Lithium-Ion Low Battery Detector	1% Accurate 2.5μA Quiescent Current, SOT-23
LTC4050	Lithium-Ion Linear Battery Charger Controller	Simple Charger uses External FET, Features Preset Voltages, C/10 Charger Detection and Programmable Timer, Input Power Good Indication, Thermistor Interface
LTC4052	Monolithic Lithium-Ion Battery Pulse Charger	No Blocking Diode or External Power FET Required
LTC4053	USB Compatible Monolithic Li-Ion Battery Charger	Standalone Charger with Programmable Timer, Up to 1.25A Charge Current
LTC4054	Standalone Linear Li-Ion Battery Charger with Integrated Pass Transistor in ThinSOT	Thermal Regulation Prevents Overheating, C/10 Termination, C/10 Indicator
LTC4410	USB Power Manager	For Simultaneous Operation of USB Peripheral and Battery Charging from USB Port, Keeps Current Drawn from USB Port Constant, Keeps Battery Fresh, Use with the LTC4053, LTC1733, or LTC4054

X-ON Electronics

Largest Supplier of Electrical and Electronic Components

Click to view similar products for [Battery Management](#) category:

Click to view products by [Analog Devices](#) manufacturer:

Other Similar products are found below :

[MP26121DQ-LF-P](#) [NCP1855FCCT1G](#) [FAN54063UCX](#) [LC05132C01NMTTTG](#) [SN2040DSQR](#) [ME4075AM5G](#) [AP5054HTCER](#) [TC2120-NB](#) [XPD977B](#) [XPD977B18](#) [4056H](#) [DW01](#) [DW06](#) [CM1002-UD](#) [CM1002-W](#) [CM1002-X](#) [CM1002-Y](#) [CM1006-B](#) [CM1006-Q](#) [CM1006-WB](#) [CM1006-LCD](#) [CM1006-LBD](#) [CM1006-WF](#) [CM1006-LF](#) [CM1006-WG](#) [CM1006-WH](#) [CM1006-LG](#) [CM1003-S02BD](#) [CM1003-S09EA](#) [CM1003-S10ED](#) [CM1003-S11ED](#) [CM1003-S12BC](#) [CM1003-S13CC](#) [CM1003-S24BC](#) [CM1003-S26BC](#) [CM1003-WAD](#) [CM1003-BBD](#) [CM1003-BFD](#) [CM1003-BND](#) [CM1003-BLD](#) [CM1003-DAD](#) [CM1003-BMD](#) [CM1003-BPD](#) [CM1003-BKD](#) [CM1003-BAE](#) [CM1003-BHE](#) [CM1102B-FF](#) [CM1102B-FD](#) [CM1102B-GD](#) [CM1112-DAE](#)