

FEATURES

- 400MHz to 4GHz Operating Frequency
- High IIP3: 28.7dBm at 700MHz, 25.7dBm at 1.95GHz
- High IIP2: 70dBm at 700MHz, 60dBm at 1.95GHz
- User Adjustable IIP2 Up to 80dBm
- User Adjustable DC Offset Null
- High Input P1dB: 16dBm at 1950MHz
- I/Q Bandwidth of 530MHz or Higher
- Image Rejection: 43dB at 1950MHz
- Noise Figure: 13.5dB at 700MHz
12.7dB at 1.95GHz
- Conversion Gain: 2.0dB at 700MHz
2.4dB at 1.95GHz
- Single-Ended RF with On-Chip Transformer
- Shutdown Mode
- Operating Temperature Range (T_C): -40°C to 105°C
- 24-Lead 4mm \times 4mm QFN Package

APPLICATIONS

- LTE/W-CDMA/TD-SCDMA Base Station Receivers
- Wideband DPD Receivers
- Point-To-Point Broadband Radios
- High Linearity Direct Conversion I/Q Receivers
- Image Rejection Receivers

DESCRIPTION

The **LTC[®]5585** is a direct conversion quadrature demodulator optimized for high linearity receiver applications in the 400MHz to 4GHz frequency range. It is suitable for communications receivers where an RF signal is directly converted into I and Q baseband signals with bandwidth of 530MHz or higher. The LTC5585 incorporates balanced I and Q mixers, LO buffer amplifiers and a precision, high frequency quadrature phase shifter. The integrated on-chip broadband transformer provides a single-ended interface at the RF input with simple off-chip L-C matching. In addition, the LTC5585 provides four analog control voltage interface pins for IIP2 and DC offset correction, greatly simplifying system calibration.

The high linearity of the LTC5585 provides excellent spur-free dynamic range for the receiver. This direct conversion demodulator can eliminate the need for intermediate frequency (IF) signal processing, as well as the corresponding requirements for image filtering and IF filtering. These I/Q outputs can interface directly to channel-select filters (LPFs) or to baseband amplifiers.

LT, LT, LTC, LTM, Linear Technology and the Linear logo are registered trademarks of Linear Technology Corporation. All other trademarks are the property of their respective owners.

TYPICAL APPLICATION

Direct Conversion Receiver with IIP2 and DC Offset Calibration

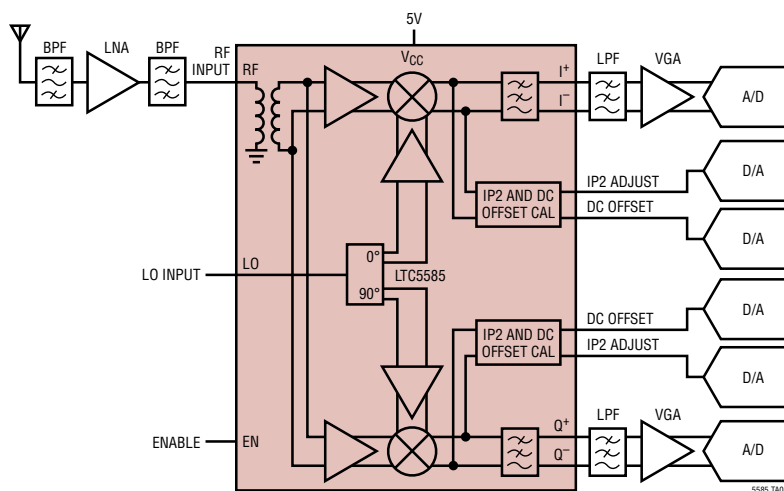

IIP2 vs IP2I, IP2Q Trim Voltage

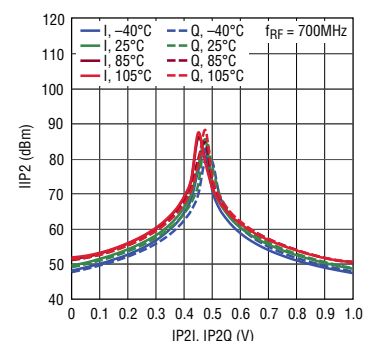

ABSOLUTE MAXIMUM RATINGS

(Note 1)

V_{CC} Supply Voltage	-0.3V to 5.5V
V_{CAP} Voltage	$V_{CC} \pm 0.05V$
I^- , I^+ , Q^+ , Q^- , CMI, CMQ Voltage	2.5V to $V_{CC} + 0.3V$
Voltage on Any Other Pin	-0.3V to $V_{CC} + 0.3V$
LO^+ , LO^- , RF Input Power	20dBm
RF Input DC Voltage	$\pm 0.1V$
Maximum Junction Temperature (T_{JMAX})	150°C
Operating Temperature Range (T_C)	-40°C to 105°C
Storage Temperature Range	-65°C to 150°C

PIN CONFIGURATION

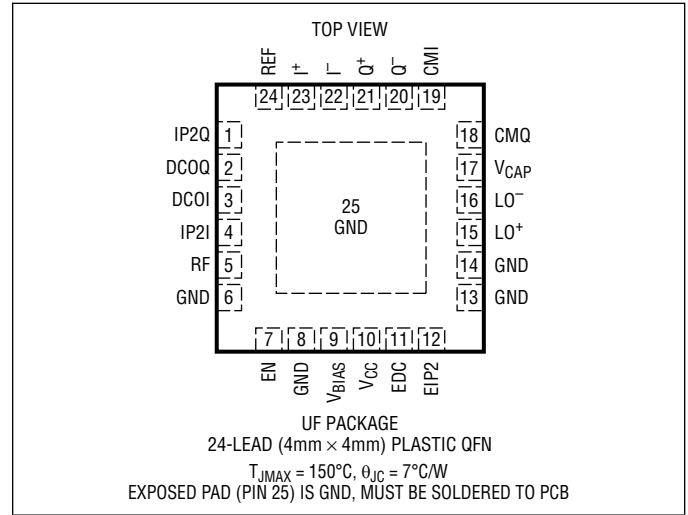

ORDER INFORMATION

LEAD FREE FINISH	TAPE AND REEL	PART MARKING	PACKAGE DESCRIPTION	TEMPERATURE RANGE
LTC5585IUF#PBF	LTC5585IUF#TRPBF	5585	24-Lead (4mm x 4mm) Plastic QFN	-40°C to 105°C

Consult LTC Marketing for parts specified with wider operating temperature ranges.

Consult LTC Marketing for information on non-standard lead based finish parts.

For more information on lead free part marking, go to: <http://www.linear.com/leadfree/>

For more information on tape and reel specifications, go to: <http://www.linear.com/tapeandreeel/>

ELECTRICAL CHARACTERISTICS

$T_C = 25^\circ C$, $V_{CC} = 5V$, $EN = 5V$, $EDC = EIP2 = 0V$, $REF = IP2I = IP2Q = DCOI = DCOQ = 0.5V$, $P_{RF} = -5dBm$ (-5dBm/tone for 2-tone IIP2 and IIP3 tests), $P_{LO} = 6dBm$, unless otherwise noted. (Notes 2, 3, 5, 6, 9)

SYMBOL	PARAMETER	CONDITIONS	MIN	TYP	MAX	UNITS
$f_{RF(RANGE)}$	RF Input Frequency Range	(Note 12)		0.4 to 4.0		GHz
$f_{LO(RANGE)}$	LO Input Frequency Range	(Note 12)		0.4 to 4.0		GHz
$P_{LO(RANGE)}$	LO Input Power Range	(Note 12)		0 to 10		dBm
$f_{RF1} = 700MHz$, $f_{RF2} = 701MHz$, $f_{LO} = 690MHz$, $L6 = 2.7pF$, $C19 = 1.0pF$, $L5 = 12nH$, $C14 = 5.6pF$						
$f_{RF(MATCH)}$	RF Input Frequency Range	Return Loss > 10dB		680 to 870		MHz
$f_{LO(MATCH)}$	LO Input Frequency Range	Return Loss > 10dB		690 to 820		MHz
G_V	Voltage Conversion Gain	Loaded with 100Ω Pull-Up (Note 8)		2.0		dB
NF	Noise Figure	Double-Side Band (Note 4)		13.5		dB
NFBLOCKING	Noise Figure Under Blocking Conditions	Double-Side Band, $P_{RF} = 0dBm$ (Note 7)		15.5		dB
IIP3	Input 3rd Order Intercept			28.7		dBm
IIP2	Input 2nd Order Intercept	Unadjusted, $EIP2 = 0V$		70		dBm
IIP2 _{OPT}	Optimized Input 2nd Order Intercept	$EIP2 = 5V$, $IP2I$, $IP2Q$ Adjusted for Minimum IM2		80		dBm
P1dB	Input 1dB Compression			16		dBm

ELECTRICAL CHARACTERISTICS $T_C = 25^\circ\text{C}$, $V_{CC} = 5\text{V}$, $E_N = 5\text{V}$, $EDC = EIP2 = 0\text{V}$, $REF = IP2I = IP2Q = DC0I = DC0Q = 0.5\text{V}$, $P_{RF} = -5\text{dBm}$ ($-5\text{dBm}/\text{tone}$ for 2-tone IIP2 and IIP3 tests), $P_{LO} = 6\text{dBm}$, unless otherwise noted. (Notes 2, 3, 5, 6, 9)

SYMBOL	PARAMETER	CONDITIONS	MIN	TYP	MAX	UNITS
DC_{OFFSET}	DC Offset at I/Q Outputs	Unadjusted, $EDC = 0\text{V}$ (Note 13)		4		mV
ΔG	I/Q Gain Mismatch			0.05		dB
$\Delta\phi$	I/Q Phase Mismatch			0.3		Deg
IRR	Image Rejection Ratio	(Note 10)		48		dB
LO-RF	LO to RF Leakage			-64		dBm
RF-LO	RF to LO Isolation			60		dB

 $f_{RF1} = 1950\text{MHz}$, $f_{RF2} = 1951\text{MHz}$, $f_{LO} = 1940\text{MHz}$, $L6 = 1.2\text{pF}$, $C19 = 5.1\text{nH}$, $L5 = 1.0\text{pF}$, $C13 = 5.1\text{nH}$

$f_{RF(\text{MATCH})}$	RF Input Frequency Range	Return Loss > 10dB		1.6 to 2.1		GHz
$f_{LO(\text{MATCH})}$	LO Input Frequency Range	Return Loss > 10dB		1.85 to 2.05		GHz
G_V	Voltage Conversion Gain	Loaded with 100 Ω Pull-Up (Note 8)		2.4		dB
NF	Noise Figure	Double-Side Band (Note 4)		12.7		dB
IIP3	Input 3rd Order Intercept			25.7		dBm
IIP2	Input 2nd Order Intercept	Unadjusted, $EIP2 = 0\text{V}$		60		dBm
IIP2 _{OPT}	Optimized Input 2nd Order Intercept	$EIP2 = 5\text{V}$, $IP2I$, $IP2Q$ Adjusted for Minimum IM2		80		dBm
P1dB	Input 1dB Compression			16		dBm
DC_{OFFSET}	DC Offset at I/Q Outputs	Unadjusted, $EDC = 0\text{V}$ (Note 13)		7		mV
ΔG	I/Q Gain Mismatch			0.05		dB
$\Delta\phi$	I/Q Phase Mismatch			0.7		Deg
IRR	Image Rejection Ratio	(Note 10)		43		dB
LO-RF	LO to RF Leakage			-49		dBm
RF-LO	RF to LO Isolation			58		dB

 $f_{RF1} = 2150\text{MHz}$, $f_{RF2} = 2151\text{MHz}$, $f_{LO} = 2140\text{MHz}$, $C17 = 1.5\text{pF}$, $L6 = 4.7\text{nH}$, $C19 = 0.5\text{pF}$, $L5 = 5.1\text{nH}$, $C14 = 0.7\text{pF}$

$f_{RF(\text{MATCH})}$	RF Input Frequency Range	Return Loss > 10dB		2.03 to 2.36		GHz
$f_{LO(\text{MATCH})}$	LO Input Frequency Range	Return Loss > 10dB		2.05 to 2.18		GHz
G_V	Voltage Conversion Gain	Loaded with 100 Ω Pull-Up (Note 8)		2.3		dB
NF	Noise Figure	Double-Side Band (Note 4)		13.0		dB
NF _{BLOCKING}	Noise Figure Under Blocking Conditions	Double-Side Band, $P_{RF} = 0\text{dBm}$ (Note 7)		14.6		dB
IIP3	Input 3rd Order Intercept			25.9		dBm
IIP2	Input 2nd Order Intercept	Unadjusted, $EIP2 = 0\text{V}$		56		dBm
IIP2 _{OPT}	Optimized Input 2nd Order Intercept	$EIP2 = 5\text{V}$, $IP2I$, $IP2Q$ Adjusted for Minimum IM2		80		dBm
P1dB	Input 1dB Compression			15		dBm
DC_{OFFSET}	DC Offset at I/Q Outputs	Unadjusted, $EDC = 0\text{V}$ (Note 13)		6		mV
ΔG	I/Q Gain Mismatch			0.05		dB
$\Delta\phi$	I/Q Phase Mismatch			1.0		Deg
IRR	Image Rejection Ratio	(Note 10)		40		dB
LO-RF	LO to RF Leakage			-50		dBm
RF-LO	RF to LO Isolation			60		dB

 $f_{RF1} = 2600\text{MHz}$, $f_{RF2} = 2601\text{MHz}$, $f_{LO} = 2590\text{MHz}$, $C17 = 0.5\text{pF}$, $L6 = 2.7\text{nH}$, $L5 = 1.2\text{nH}$, $C14 = 1\text{pF}$

$f_{RF(\text{MATCH})}$	RF Input Frequency Range	Return Loss > 10dB		2.35 to 3.1		GHz
$f_{LO(\text{MATCH})}$	LO Input Frequency Range	Return Loss > 10dB		2.47 to 2.65		GHz
G_V	Voltage Conversion Gain	Loaded with 100 Ω Pull-Up (Note 8)		2.3		dB

ELECTRICAL CHARACTERISTICS

$T_C = 25^\circ\text{C}$, $V_{CC} = 5\text{V}$, $EN = 5\text{V}$, $EDC = EIP2 = 0\text{V}$, $REF = IP2I = IP2Q = DCOI = DCOQ = 0.5\text{V}$, $P_{RF} = -5\text{dBm}$ ($-5\text{dBm}/\text{tone}$ for 2-tone IIP2 and IIP3 tests), $P_{LO} = 6\text{dBm}$, unless otherwise noted. (Notes 2, 3, 5, 6, 9)

SYMBOL	PARAMETER	CONDITIONS	MIN	TYP	MAX	UNITS
NF	Noise Figure	Double-Side Band (Note 4)		13.6		dB
NF _{BLOCKING}	Noise Figure Under Blocking Conditions	Double-Side Band, $P_{RF} = 0\text{dBm}$ (Note 7)		15.2		dB
IIP3	Input 3rd Order Intercept			27.5		dBm
IIP2	Input 2nd Order Intercept	Unadjusted, $EIP2 = 0\text{V}$		60		dBm
IIP2 _{OPT}	Minimum Input 2nd Order Intercept	$EIP2 = 5\text{V}$, $IP2I$, $IP2Q$ Adjusted for Minimum $IM2$		80		dBm
P1dB	Input 1dB Compression			15.5		dBm
DC _{OFFSET}	DC Offset at I/Q Outputs	Unadjusted, $EDC = 0\text{V}$ (Note 13)		8		mV
ΔG	I/Q Gain Mismatch			0.05		dB
$\Delta\phi$	I/Q Phase Mismatch			1.0		Deg
IRR	Image Rejection Ratio	(Note 10)		40		dB
LO-RF	LO to RF Leakage			-46		dBm
RF-LO	RF to LO Isolation			55		dB

$f_{RF1} = 3500\text{MHz}$, $f_{RF2} = 3501\text{MHz}$, $f_{LO} = 3490\text{MHz}$, $C17 = 0.6\text{pF}$, $L6 = 1.0\text{nH}$, $C13 = 0.7\text{pF}$, $L5 = \text{Short}$, $C14 = \text{Open}$, Single-Ended LO (See Figure 14)

$f_{RF}(\text{MATCH})$	RF Input Frequency Range	Return Loss > 10dB		2.88 to 3.97		GHz
$f_{LO}(\text{MATCH})$	LO Input Frequency Range	Return Loss > 10dB		2.97 to 3.96		GHz
G_V	Voltage Conversion Gain	Loaded with 100Ω Pull-Up (Note 8)		0.3		dB
NF	Noise Figure	Double-Side Band (Note 4)		17.1		dB
IIP3	Input 3rd Order Intercept			28.1		dBm
IIP2	Input 2nd Order Intercept	Unadjusted, $EIP2 = 0\text{V}$		52.5		dBm
IIP2 _{OPT}	Minimum Input 2nd Order Intercept	$EIP2 = 5\text{V}$, $IP2I$, $IP2Q$ Adjusted for Minimum $IM2$		65.9		dBm
P1dB	Input 1dB Compression			17.1		dBm
DC _{OFFSET}	DC Offset at I/Q Outputs	Unadjusted, $EDC = 0\text{V}$ (Note 13)		16.5		mV
ΔG	I/Q Gain Mismatch			0.04		dB
$\Delta\phi$	I/Q Phase Mismatch			1.8		Deg
IRR	Image Rejection Ratio	(Note 10)		36		dB
LO-RF	LO to RF Leakage			-34.7		dBm
RF-LO	RF to LO Isolation			44.5		dB

Power Supply and Other Parameters

V_{CC}	Supply Voltage		4.75	5.0	5.25	V
I_{CC}	Supply Current	$EDC = EIP2 = 5\text{V}$	180	200	220	mA
$I_{CC}(\text{LOW})$	Supply Current	$EDC = EIP2 = 0\text{V}$	170	190	210	mA
$I_{CC}(\text{OFF})$	Shutdown Current	$EN < 0.3\text{V}$		11	900	μA
t_{ON}	Turn-On Time	EN Transition from Logic Low to High (Note 14)		0.2		μs
t_{OFF}	Turn-Off Time	EN Transition from Logic High to Low (Note 15)		0.8		μs
V_{EH}	EN , EDC , $EIP2$ Input High Voltage (On)		2.0			V
V_{EL}	EN , EDC , $EIP2$ Input Low Voltage (Off)				0.3	V
I_{ENH}	EN Pin Input Current	$EN = 5.0\text{V}$		52		μA
I_{EDCH}	EDC Pin Input Current	$EDC = 5.0\text{V}$		33		μA

ELECTRICAL CHARACTERISTICS

SYMBOL	PARAMETER	CONDITIONS	MIN	TYP	MAX	UNITS
I_{EIP2H}	EIP2 Pin Input Current	EIP2 = 5.0V		50		μ A
V_{REF}	REF Pin Voltage	With REF Pin Unloaded		0.5		V
$V_{REF(RANGE)}$	REF Pin Voltage Range	When Driven with External Source		0.4 to 0.7		V
Z_{REF}	REF Input Impedance	(Note 11)		2 1		k Ω pF
	DCOI, DCOQ, IP2I, IP2Q Pin Voltage	Unloaded		0.5		V
	DCOI, DCOQ, IP2I, IP2Q Voltage Range	When Driven with External Source		0 to 2V _{REF}		V
	DCOI, DCOQ, IP2I, IP2Q Impedance	(Note 11)		8 1		k Ω pF
	DCOI, DCOQ, IP2I, IP2Q Settling Time	For Step Input, Output with 90% of Final Value		20		ns
	DC Offset Adjustment Range	DCOI, DCOQ Swept from 0V to 1V, EDC = 5V		\pm 20		mV
	DC Offset Drift Over Temperature	Unadjusted, EDC = 0V		20		μ V/ $^{\circ}$ C
V_{CM}	I ⁺ , I ⁻ , Q ⁺ , Q ⁻ Common Mode Voltage			V _{CC} - 1.5		V
Z_{OUT}	I ⁺ , I ⁻ , Q ⁺ , Q ⁻ Output Impedance	Single Ended		100 6		Ω pF
BW_{BB}	I ⁺ , I ⁻ , Q ⁺ , Q ⁻ Output Bandwidth	100 Ω External Pull-Up, -3dB Corner Frequency		530		MHz

Note 1: Stresses beyond those listed under Absolute Maximum Ratings may cause permanent damage to the device. Exposure to any Absolute Maximum Rating condition for extended periods may affect device reliability and lifetime.

Note 2: Tests are performed with the test circuit of Figure 1.

Note 3: The LTC5585 is guaranteed to be functional over the -40 $^{\circ}$ C to 105 $^{\circ}$ C case temperature operating range.

Note 4: DSB noise figure is measured at the baseband frequency of 15MHz with a small-signal noise source without any filtering on the RF input and no other RF signal applied.

Note 5: Performance at the RF frequencies listed is measured with external RF and LO impedance matching, as shown in the table of Figure 1.

Note 6: The complementary outputs (I⁺, I⁻ and Q⁺, Q⁻) are combined using a 180 $^{\circ}$ phase-shift combiner.

Note 7: Noise figure under blocking conditions (NF_{BLOCKING}) is measured at an output frequency of 60MHz with RF input signal at $f_{LO} + 1$ MHz. Both RF and LO input signals are appropriately filtered, as well as the baseband output. NF_{BLOCKING} measured at 840MHz, 2140MHz and 2500MHz only.

Note 8: Voltage conversion gain is calculated from the average measured power conversion gain of the I and Q outputs using the test circuit shown in Figure 1. Power conversion gain is measured with a 100 Ω differential load impedance on the I and Q outputs.

Note 9: Baseband outputs have a 100 Ω external pull-up resistor to V_{CC} as shown in the test circuit shown in Figure 1.

Note 10: Image rejection is calculated from the measured gain error and phase error using the method listed in the appendix.

Note 11: The DCOI, DCOQ, IP2I, IP2Q pins have an 8k internal resistor to ground. The REF pin has a 2k internal resistor to ground. If unconnected, these pins will float up to 500mV through internal current sources. A low output resistance voltage source is recommended for driving these pins.

Note 12: This is the recommended operating range, operation outside the listed range is possible with degraded performance to some parameters.

Note 13: DC offset measured differentially between I⁺ and I⁻ and between Q⁺ and Q⁻. The reported value is the mean of the absolute values of the characterization data distribution.

Note 14: Baseband amplitude is within 10% of final value.

Note 15: Baseband amplitude is at least 30dB down from its on state.

DC PERFORMANCE CHARACTERISTICS EN = 5V, EDC = 0V and EIP2 = 0V. Test circuit shown in Figure 1

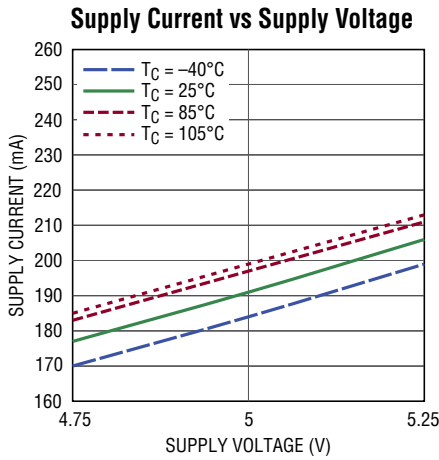

5585 G01

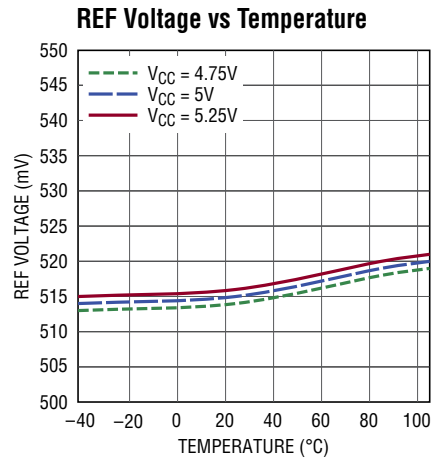

5585 G02

TYPICAL PERFORMANCE CHARACTERISTICS 700MHz application. $V_{CC} = 5\text{V}$, EN = 5V, EDC = 0V, EIP2 = 0V, REF = 0.5V, $T_C = 25^\circ\text{C}$, $P_{LO} = 6\text{dBm}$, $f_{LO} = 690\text{MHz}$, $f_{RF1} = 700\text{MHz}$, $f_{RF2} = 701\text{MHz}$, $f_{BB} = 10\text{MHz}$, $P_{RF1} = P_{RF2} = -5\text{dBm}$, DC Blocks and Mini-Circuits PSCJ-2-1 180° combiner at baseband outputs de-embedded from measurement unless otherwise noted. Test circuit with RF and LO ports impedance matched as in Figure 1.

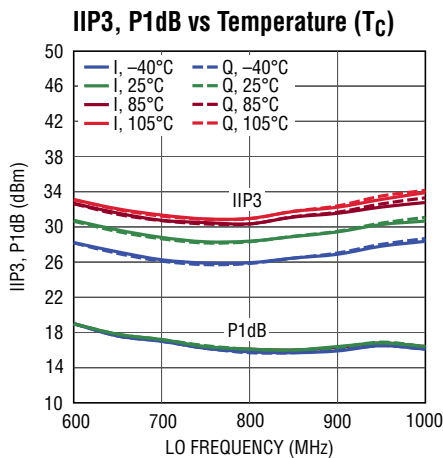

5585 G03

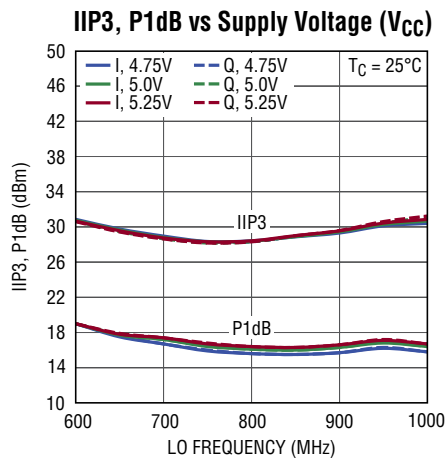

5585 G04

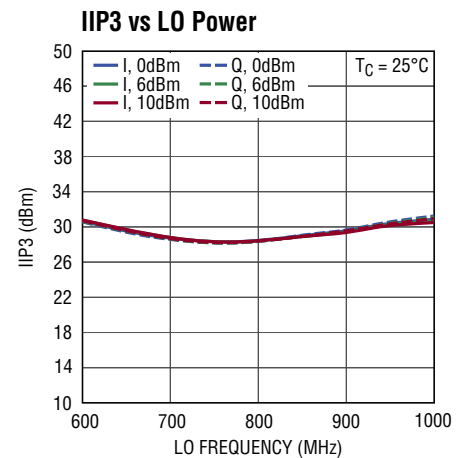

5585 G05

TYPICAL PERFORMANCE CHARACTERISTICS 700MHz application. $V_{CC} = 5V$, $EN = 5V$, $EDC = 0V$, $EIP2 = 0V$, $REF = 0.5V$, $T_C = 25^\circ C$, $P_{LO} = 6dBm$, $f_{LO} = 690MHz$, $f_{RF1} = 700MHz$, $f_{RF2} = 701MHz$, $f_{BB} = 10MHz$, $P_{RF1} = P_{RF2} = -5dBm$, DC Blocks and Mini-Circuits PSCJ-2-1 180° combiner at baseband outputs de-embedded from measurement unless otherwise noted. Test circuit with RF and LO ports impedance matched as in Figure 1.

2-Tone IIP3 vs RF Power

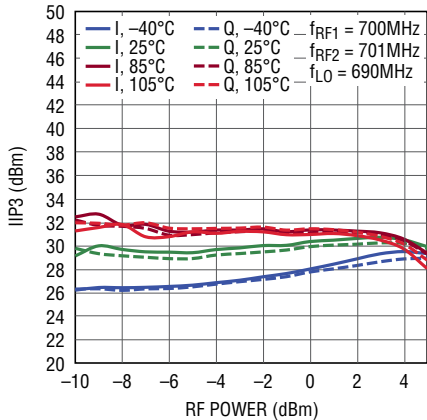

5585 G06

Uncalibrated IIP2 vs Temperature (T_C)

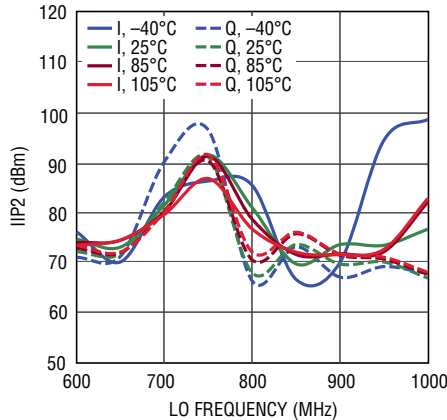

5585 G07

Uncalibrated IIP2 vs LO Power

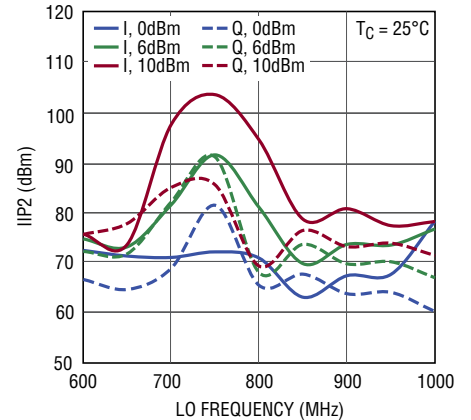

5585 G08

IIP2 vs IP2I, IP2Q Trim Voltage

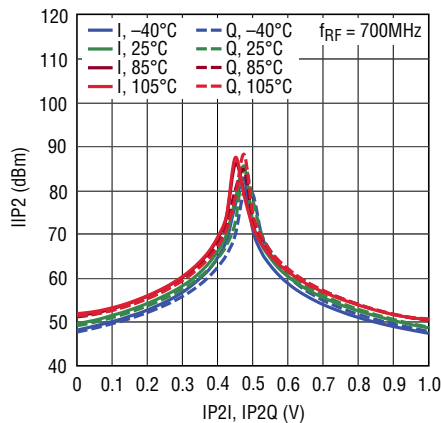

5585 G09

IIP2 vs RF Tone Spacing

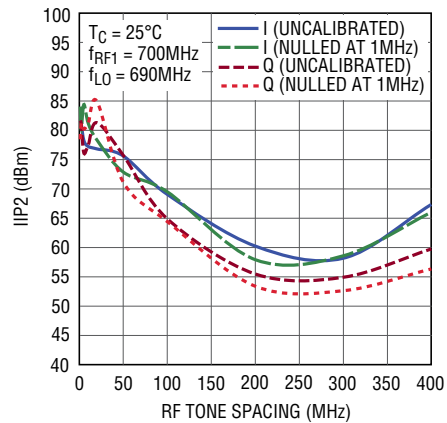

5585 G10

2x2 Half-IF IIP2 vs RF to LO Tone Spacing

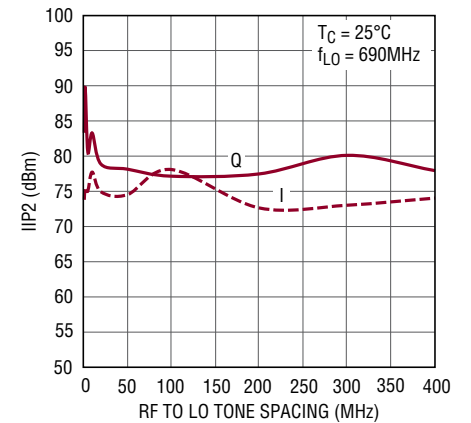

5585 G11

Noise Figure and Conversion Gain vs Temperature (T_C)

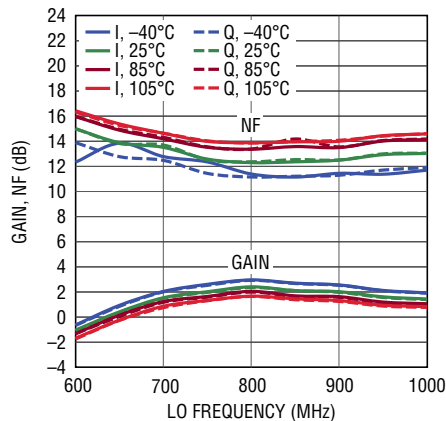

5585 G12

Noise Figure and Conversion Gain vs LO Power

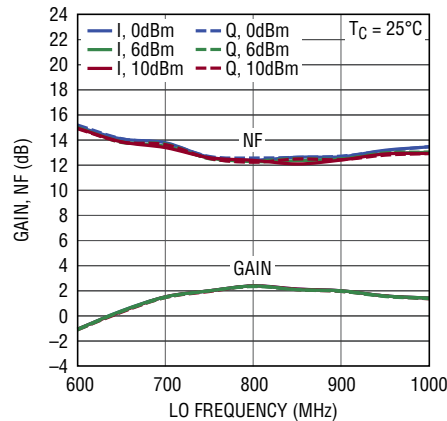

5585 G13

Noise Figure vs RF Power and IP2I, IP2Q Trim Voltage

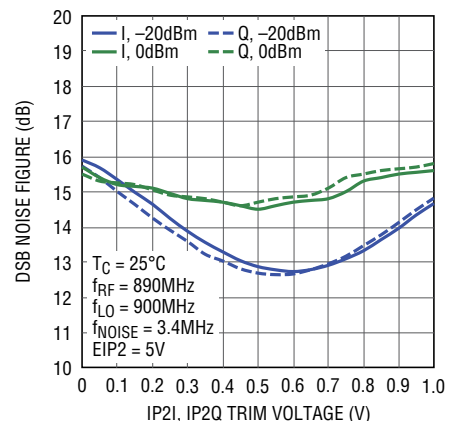

5585 G14

5585fb

TYPICAL PERFORMANCE CHARACTERISTICS

700MHz application. $V_{CC} = 5V$, $EN = 5V$, $EDC = 0V$, $EIP2 = 0V$, $REF = 0.5V$, $T_C = 25^\circ C$, $P_{LO} = 6dBm$, $f_{LO} = 690MHz$, $f_{RF1} = 700MHz$, $f_{RF2} = 701MHz$, $f_{BB} = 10MHz$, $P_{RF1} = P_{RF2} = -5dBm$, DC Blocks and Mini-Circuits PSCJ-2-1 180° combiner at baseband outputs de-embedded from measurement unless otherwise noted. Test circuit with RF and LO ports impedance matched as in Figure 1.

Noise Figure vs RF Input Power with $f_{NOISE} = 60MHz$

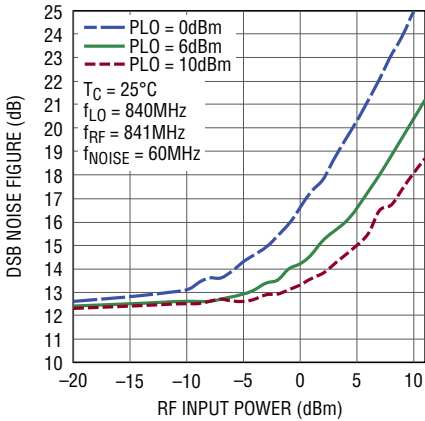

5585 G15

Noise Figure vs RF Input Power with $f_{NOISE} = 3.4MHz$

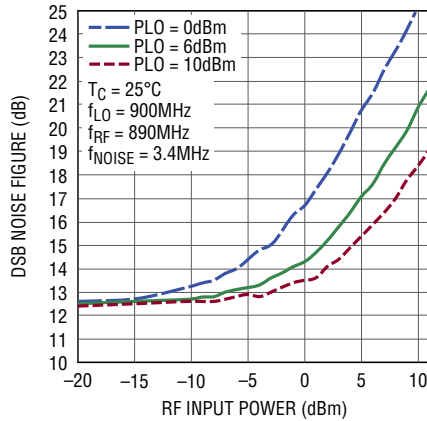

5585 G16

DC Offset vs DCOI, DCOQ Control Voltage

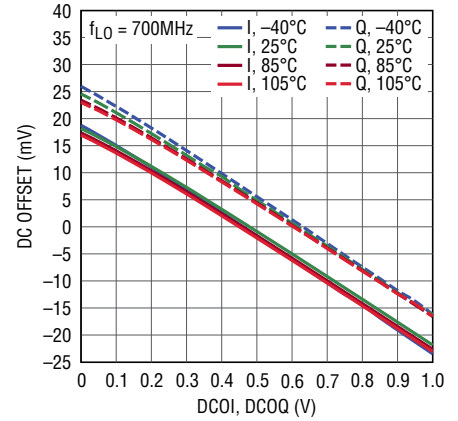

5585 G17

DC Offset vs LO Power

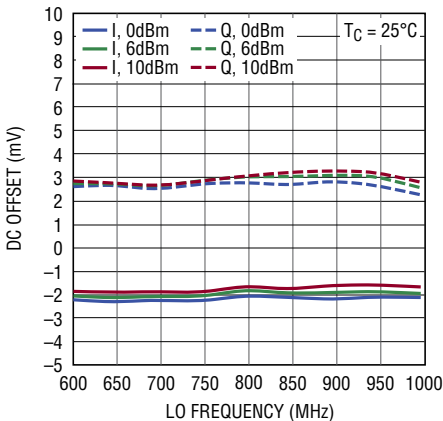

5585 G18

LO to RF Leakage and RF to LO Isolation

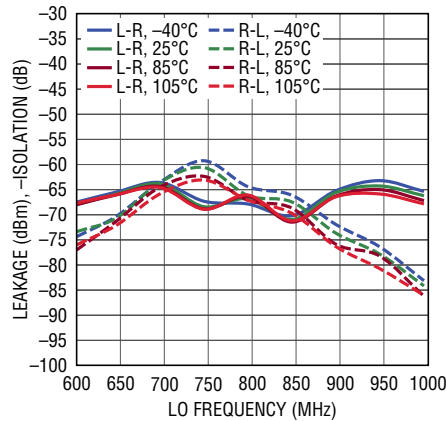

5585 G19

Image Rejection vs Temperature (Note 10)

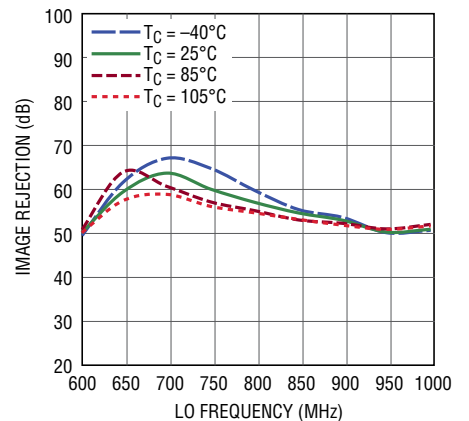

5585 G20

TYPICAL PERFORMANCE CHARACTERISTICS 1950MHz application. $V_{CC} = 5V$, $EN = 5V$, $EDC = 0V$, $REF = 0.5V$, $EIP2 = 0V$, $T_C = 25^\circ C$, $P_{LO} = 6dBm$, $f_{LO} = 1940MHz$, $f_{RF1} = 1950MHz$, $f_{RF2} = 1951MHz$, $f_{BB} = 10MHz$, $P_{RF1} = P_{RF2} = -5dBm$, DC Blocks and Mini-Circuits PSCJ-2-1 180° combiner at baseband outputs de-embedded from measurement unless otherwise noted. Test circuit with RF and LO ports impedance matched as in Figure 1.

IIP3, P1dB vs Temperature (T_C)

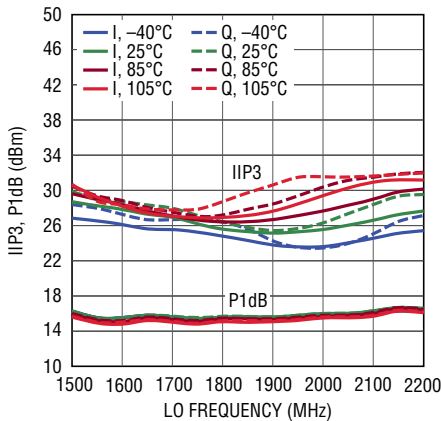

5585 G21

IIP3, P1dB vs Supply Voltage

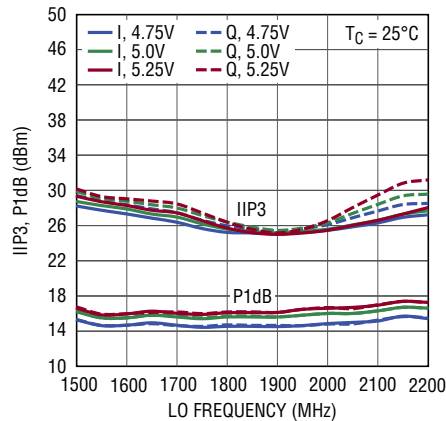

5585 G22

IIP3 vs LO Power

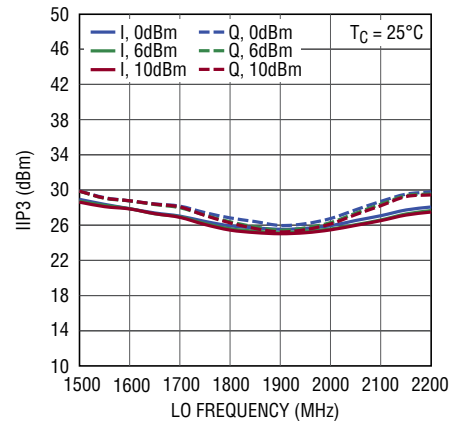

5585 G23

2-Tone IIP3 vs RF Power

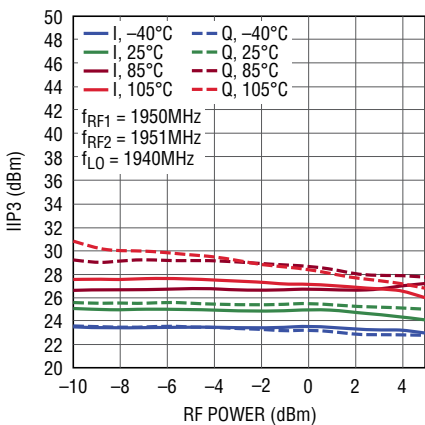

5585 G24

Uncalibrated IIP2 vs Temperature (T_C)

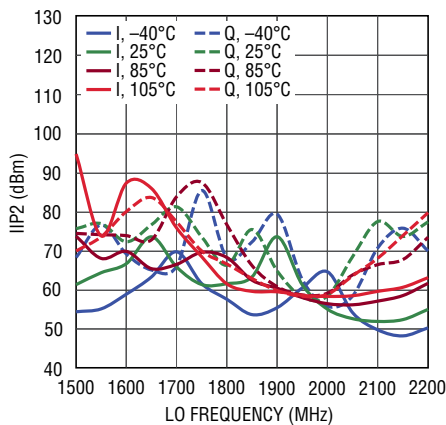

5585 G25

Uncalibrated IIP2 vs LO Power

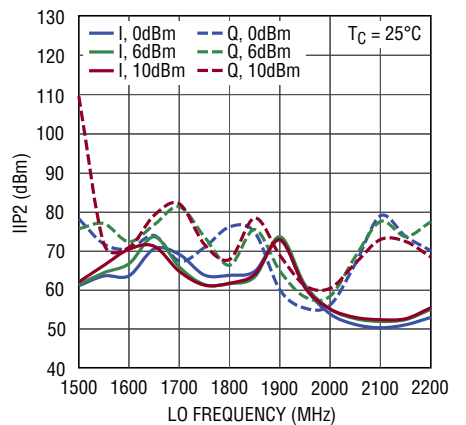

5585 G26

IIP2 vs IP2I, IP2Q Trim Voltage

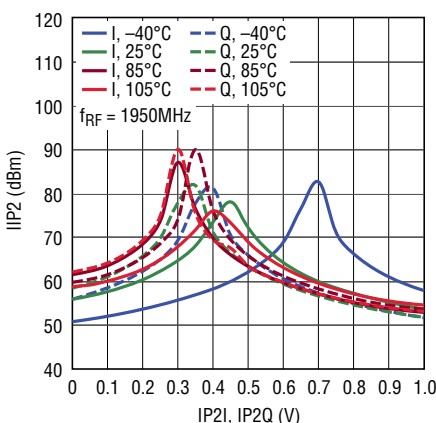

5585 G27

IIP2 vs RF Tone Spacing

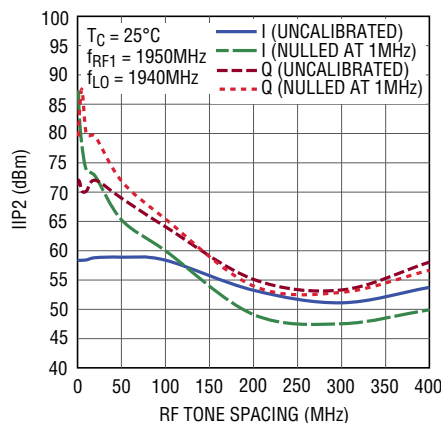

5585 G28

2x2 Half-IF IIP2 vs RF to LO Tone Spacing

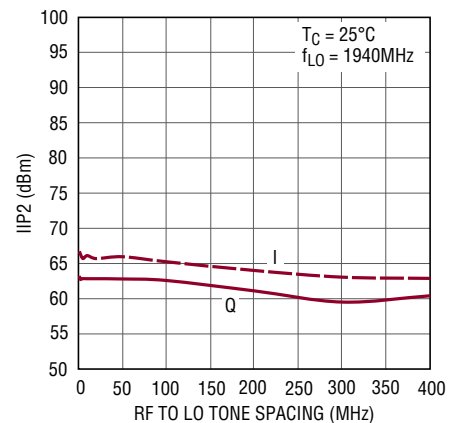

5585 G29

5585fb

TYPICAL PERFORMANCE CHARACTERISTICS 1950MHz application. $V_{CC} = 5V$, $EN = 5V$, $EDC = 0V$, $REF = 0.5V$, $EIP2 = 0V$, $T_C = 25^\circ C$, $P_{LO} = 6dBm$, $f_{LO} = 1940MHz$, $f_{RF1} = 1950MHz$, $f_{RF2} = 1951MHz$, $f_{BB} = 10MHz$, $P_{RF1} = P_{RF2} = -5dBm$, DC Blocks and Mini-Circuits PSCJ-2-1 180° combiner at baseband outputs de-embedded from measurement unless otherwise noted. Test circuit with RF and LO ports impedance matched as in Figure 1.

Noise Figure and Conversion Gain vs Temperature (T_C)

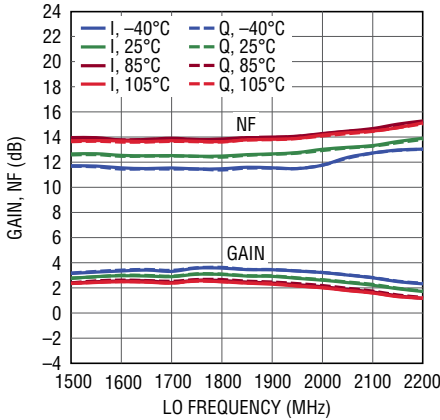

5585 G30

Noise Figure and Conversion Gain vs LO Power

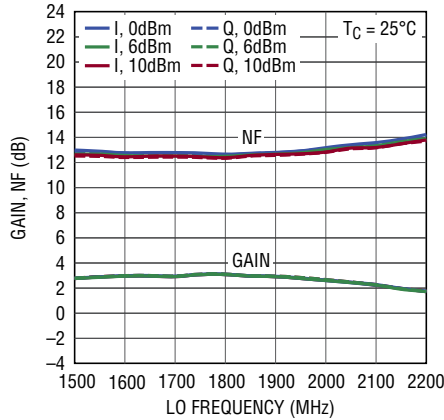

5585 G31

DC Offset vs DCOI, DCOQ Control Voltage

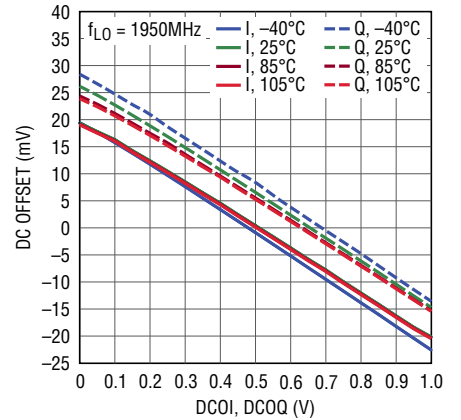

5585 G32

DC Offset vs LO Power

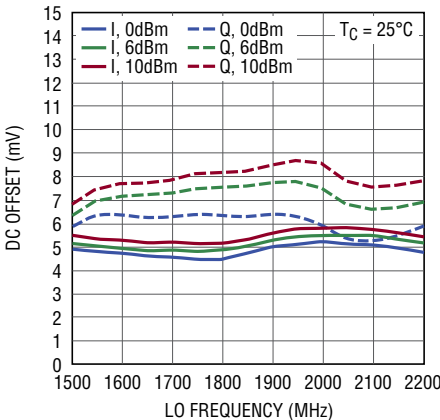

5585 G33

LO to RF Leakage and RF to LO Isolation

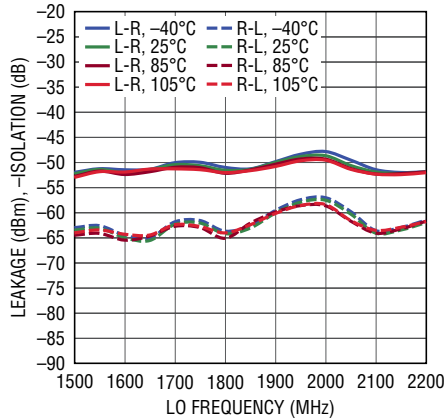

5585 G34

Image Rejection vs Temperature (Note 10)

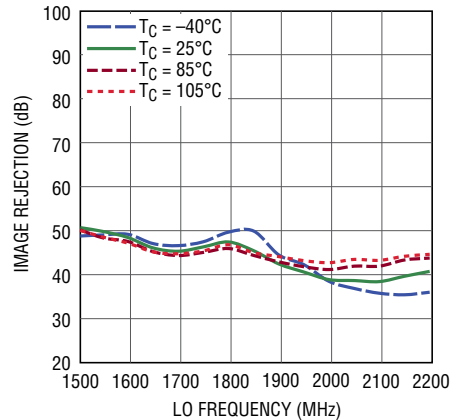

5585 G35

Conversion Gain Distribution

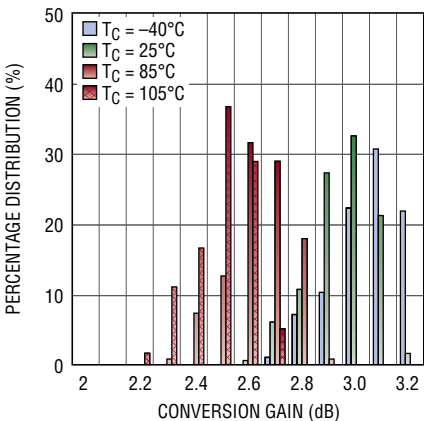

5585 G36

IIP3 Distribution, I Side

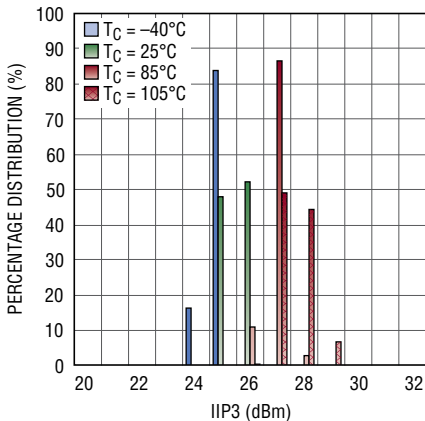

5585 G37

IIP3 Distribution, Q Side

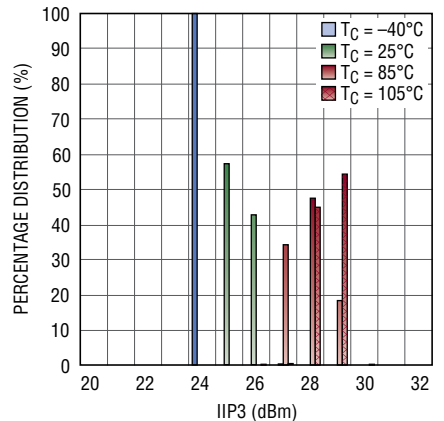

5585 G38

5585fb

TYPICAL PERFORMANCE CHARACTERISTICS 1950MHz application. $V_{CC} = 5V$, $EN = 5V$, $EDC = 0V$, $REF = 0.5V$, $EIP2 = 0V$, $T_C = 25^\circ C$, $P_{LO} = 6dBm$, $f_{LO} = 1940MHz$, $f_{RF1} = 1950MHz$, $f_{RF2} = 1951MHz$, $f_{BB} = 10MHz$, $P_{RF1} = P_{RF2} = -5dBm$, DC Blocks and Mini-Circuits PSCJ-2-1 180° combiner at baseband outputs de-embedded from measurement unless otherwise noted. Test circuit with RF and LO ports impedance matched as in Figure 1.

DSB Noise Figure Distribution, I Side

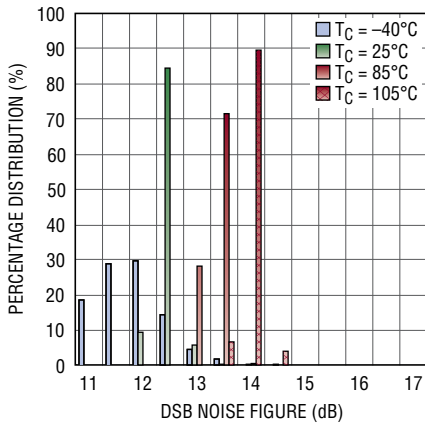

5585 G39

DSB Noise Figure Distribution, Q Side

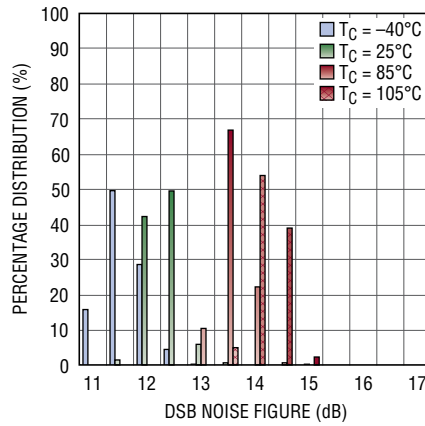

5585 G40

IIP2 Distribution, I Side

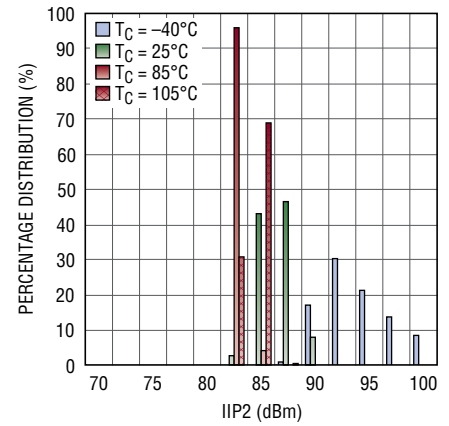

5585 G41

IIP2 Distribution, Q Side

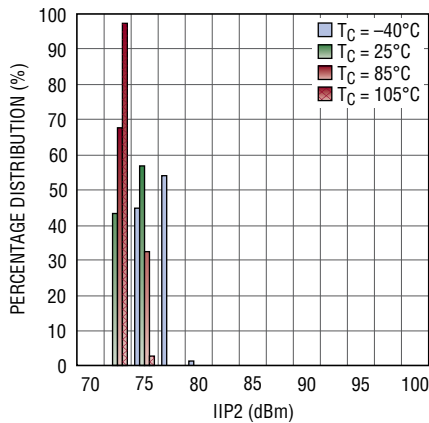

5585 G42

Gain Error Distribution

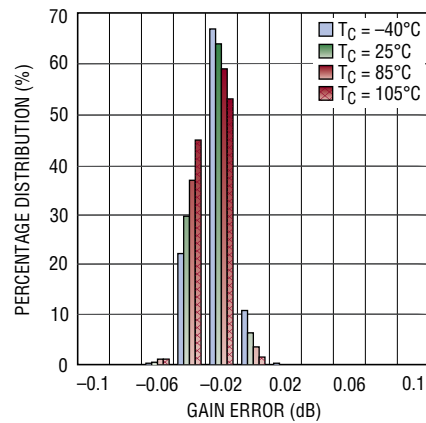

5585 G43

Phase Error Distribution

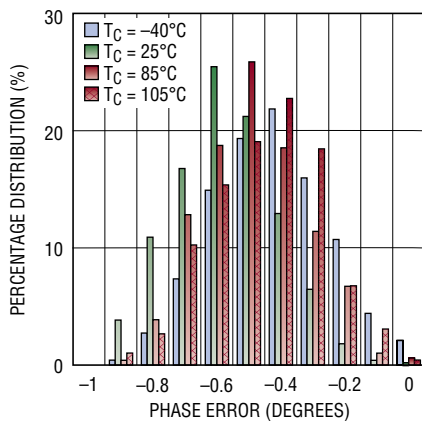

5585 G44

Image Rejection Distribution (Note 10)

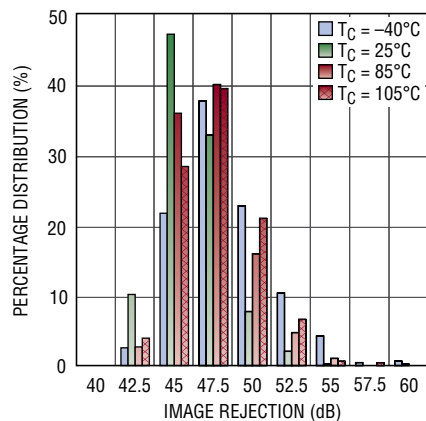

5585 G45

TYPICAL PERFORMANCE CHARACTERISTICS 2150MHz application. $V_{CC} = 5V$, $EN = 5V$, $EDC = 0V$, $EIP2 = 0V$, $REF = 0.5V$, $T_C = 25^\circ C$, $P_{LO} = 6dBm$, $f_{LO} = 2140MHz$, $f_{RF1} = 2150MHz$, $f_{RF2} = 2151MHz$, $f_{BB} = 10MHz$, $P_{RF1} = P_{RF2} = -5dBm$, DC Blocks and Mini-Circuits PSCJ-2-1 180° combiner at baseband outputs de-embedded from measurement unless otherwise noted. Test circuit with RF and LO ports impedance matched as in Figure 1.

IIP3, P1dB vs Temperature (T_C)

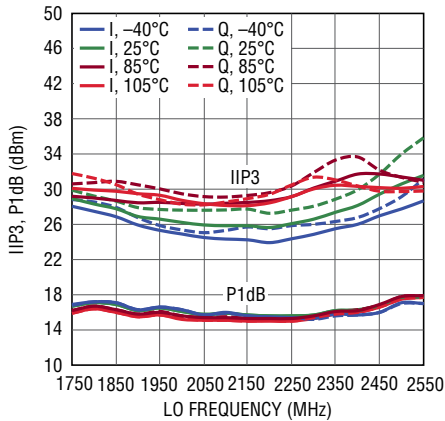

5585 G46

IIP3, P1dB vs Supply Voltage (V_{CC})

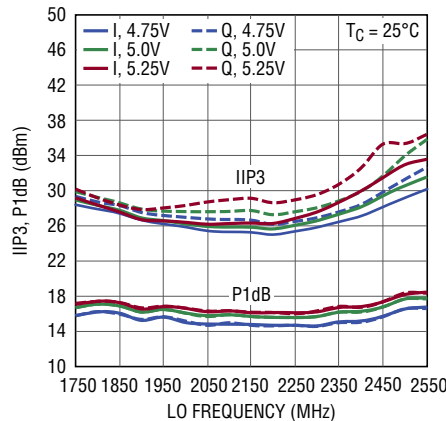

5585 G47

IIP3 vs LO Power

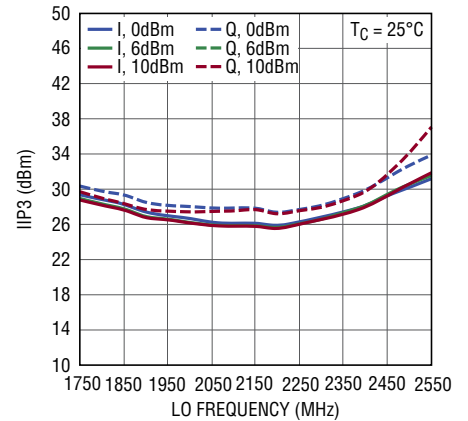

5585 G48

2-Tone IIP3 vs RF Power

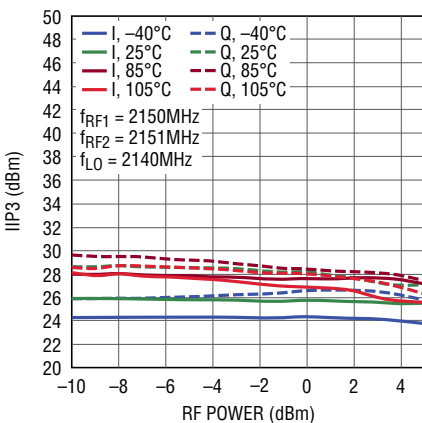

5585 G49

Uncalibrated IIP2 vs Temperature (T_C)

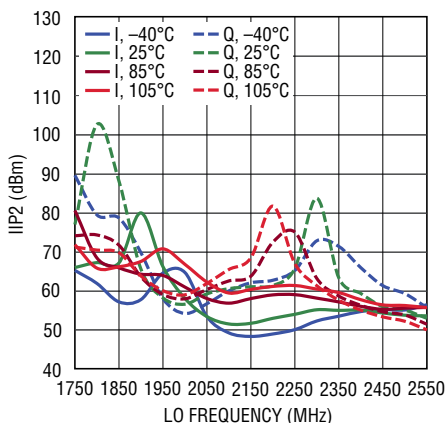

5585 G50

Uncalibrated IIP2 vs LO Power

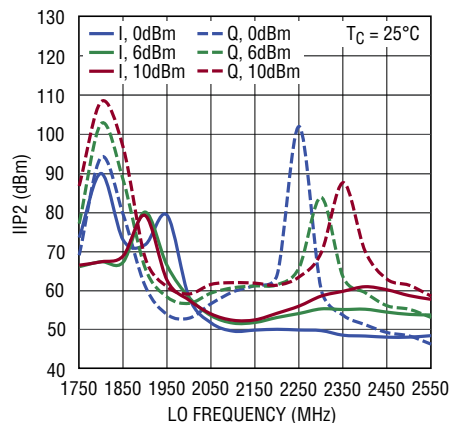

5585 G51

IIP2 vs IP2I, IP2Q Trim Voltage

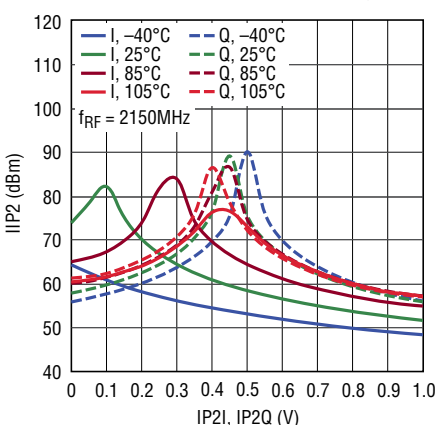

5585 G52

IIP2 vs RF Tone Spacing

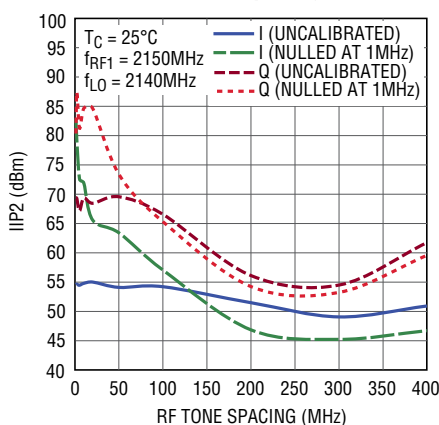

5585 G53

2x2 Half-IF IIP2 vs RF to LO Tone Spacing

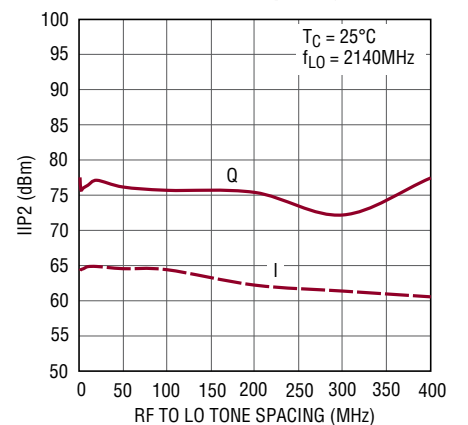

5585 G54

5585fb

TYPICAL PERFORMANCE CHARACTERISTICS 2150MHz application. $V_{CC} = 5V$, $EN = 5V$, $EDC = 0V$, $EIP2 = 0V$, $REF = 0.5V$, $T_C = 25^\circ C$, $P_{LO} = 6dBm$, $f_{LO} = 2140MHz$, $f_{RF1} = 2150MHz$, $f_{RF2} = 2151MHz$, $f_{BB} = 10MHz$, $P_{RF1} = P_{RF2} = -5dBm$, DC Blocks and Mini-Circuits PSCJ-2-1 180° combiner at baseband outputs de-embedded from measurement unless otherwise noted. Test circuit with RF and LO ports impedance matched as in Figure 1.

Noise Figure vs RF Input Power

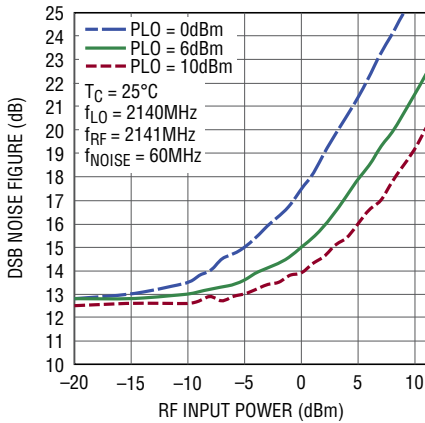

5585 G55

Noise Figure and Conversion Gain vs Temperature (T_C)

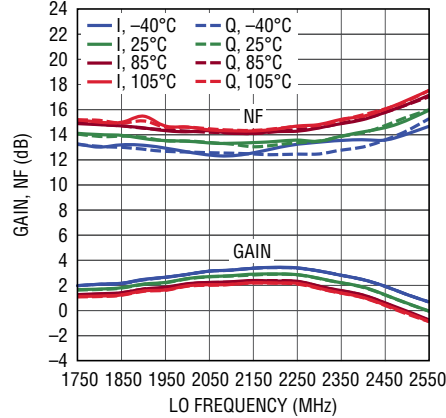

5585 G56

Noise Figure and Conversion Gain vs LO Power

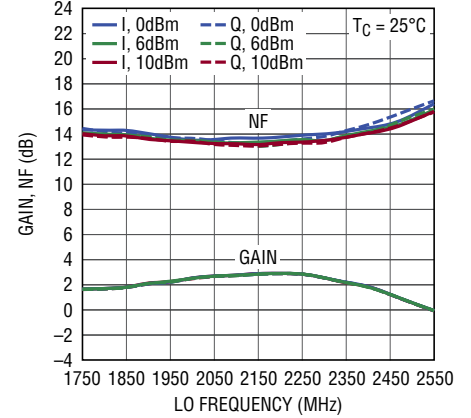

5585 G57

DC Offset vs DCOI, DCOQ Control Voltage

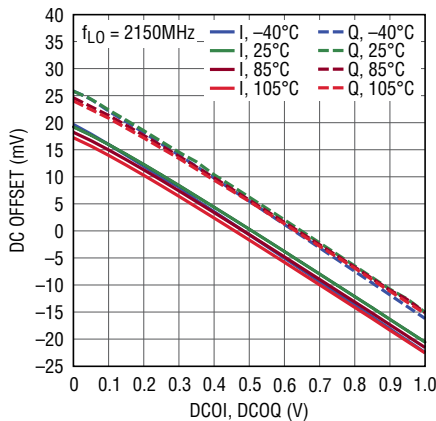

5585 G58

DC Offset vs LO Power

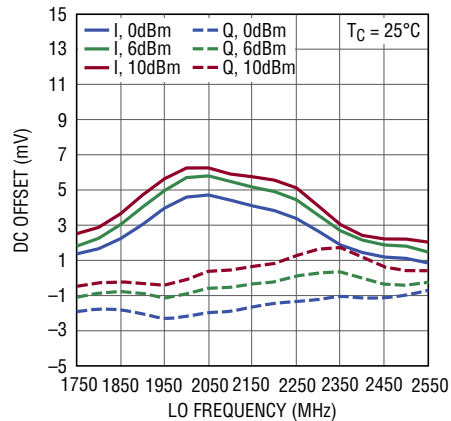

5585 G59

LO to RF Leakage and RF to LO Isolation

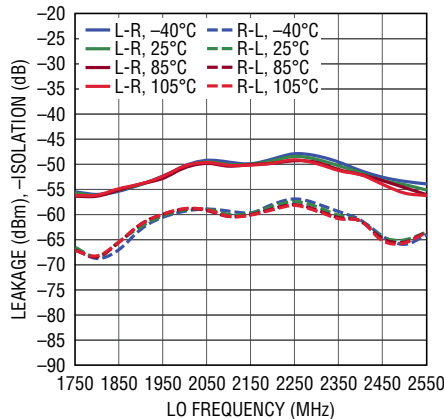

5585 G60

Image Rejection vs Temperature (Note 10)

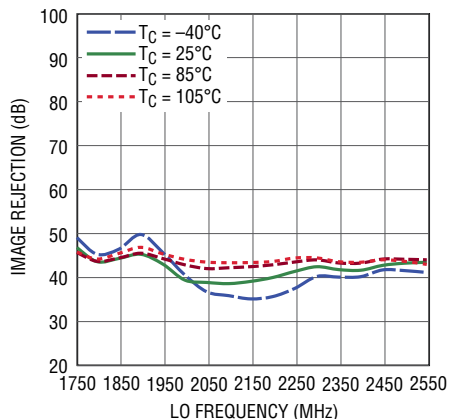

5585 G61

TYPICAL PERFORMANCE CHARACTERISTICS 2600MHz application. $V_{CC} = 5V$, $EN = 5V$, $EDC = 0V$, $EIP2 = 0V$, $REF = 0.5V$, $T_C = 25^\circ C$, $P_{LO} = 6dBm$, $f_{LO} = 2590MHz$, $f_{RF1} = 2600MHz$, $f_{RF2} = 2601MHz$, $f_{BB} = 10MHz$, $P_{RF1} = P_{RF2} = -5dBm$, DC Blocks and Mini-Circuits PSCJ-2-1 180° combiner at baseband outputs de-embedded from measurement unless otherwise noted. Test circuit with RF and LO ports impedance matched as in Figure 1.

IIP3, P1dB vs Temperature (T_C)

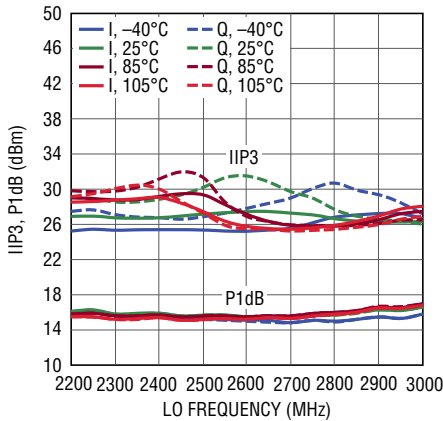

5585 G62

IIP3, P1dB vs Supply Voltage (V_{CC})

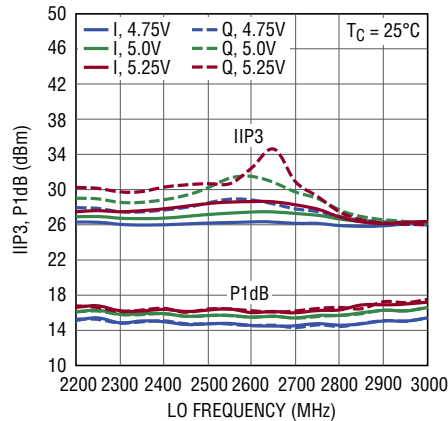

5585 G63

IIP3 vs LO Power

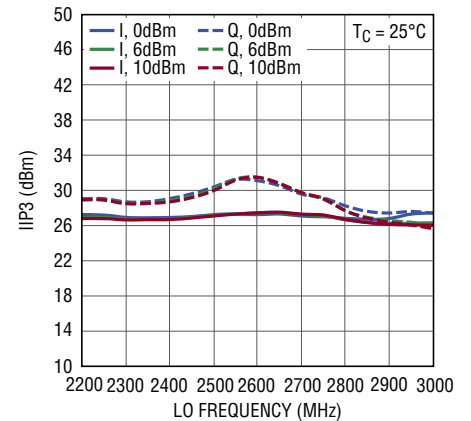

5585 G64

2-Tone IIP3 vs RF Power

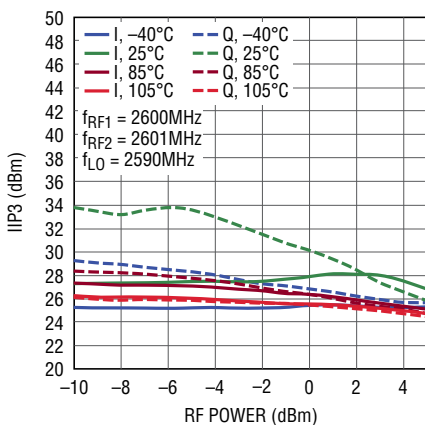

5585 G65

Uncalibrated IIP2 vs Temperature (T_C)

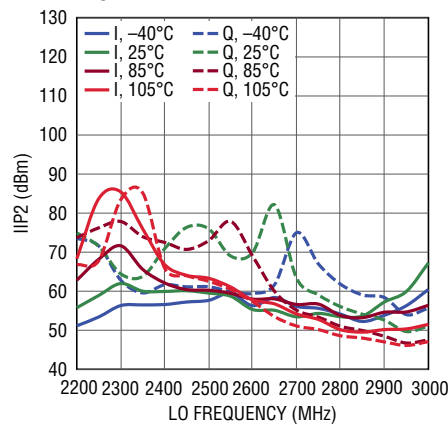

5585 G66

Uncalibrated IIP2 vs LO Power

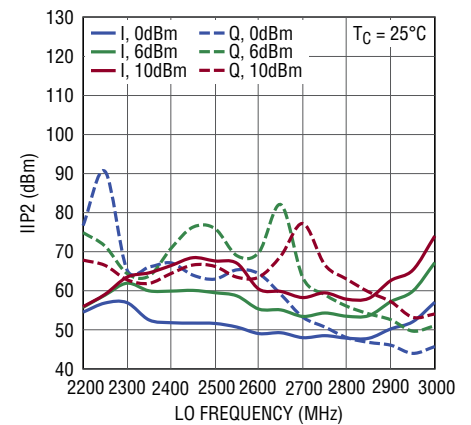

5585 G66

IIP2 vs IP2I, IP2Q Trim Voltage

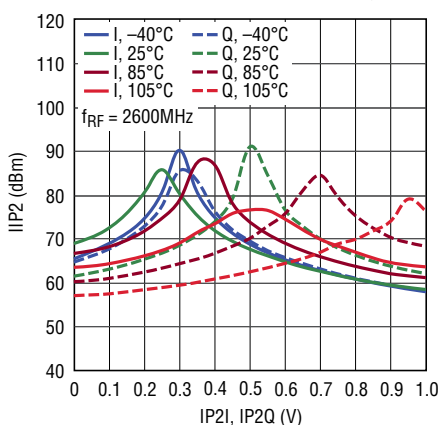

5585 G68

IIP2 vs RF Tone Spacing

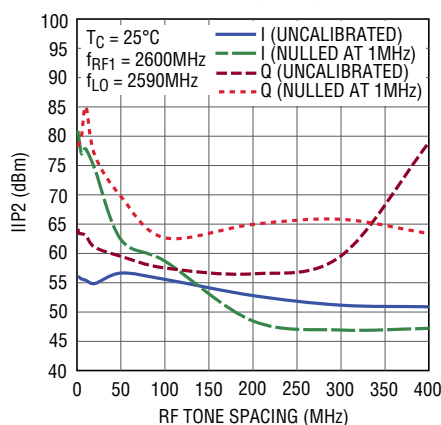

5585 G69

2x2 Half-IF IIP2 vs RF to LO Tone Spacing

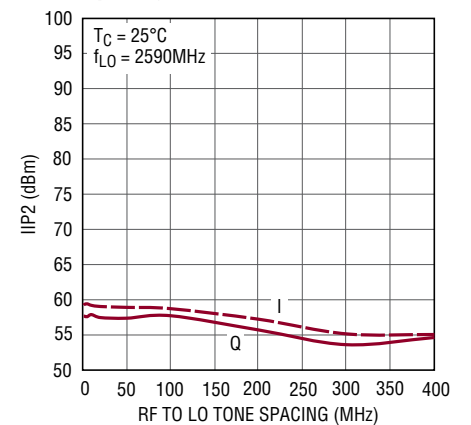

5585 G70

TYPICAL PERFORMANCE CHARACTERISTICS 2600MHz application. $V_{CC} = 5V$, $EN = 5V$, $EDC = 0V$, $EIP2 = 0V$, $REF = 0.5V$, $T_C = 25^\circ C$, $P_{LO} = 6dBm$, $f_{LO} = 2590MHz$, $f_{RF1} = 2600MHz$, $f_{RF2} = 2601MHz$, $f_{BB} = 10MHz$, $P_{RF1} = P_{RF2} = -5dBm$, DC Blocks and Mini-Circuits PSCJ-2-1 180° combiner at baseband outputs de-embedded from measurement unless otherwise noted. Test circuit with RF and LO ports impedance matched as in Figure 1.

Noise Figure and Conversion Gain vs Temperature (T_C)

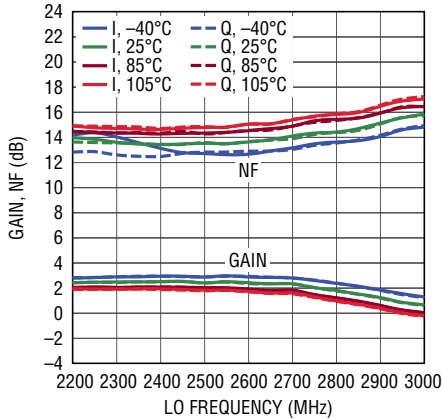

5585 G71

Noise Figure and Conversion Gain vs LO Power

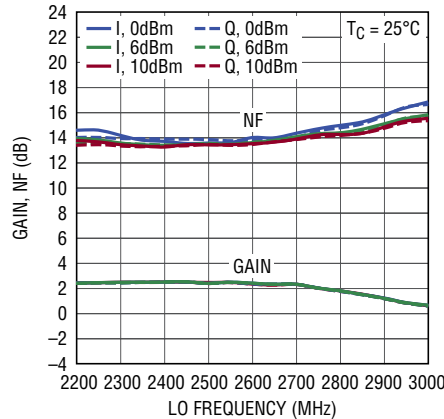

5585 G72

Noise Figure vs RF Power and IP2I, IP2Q Trim Voltage

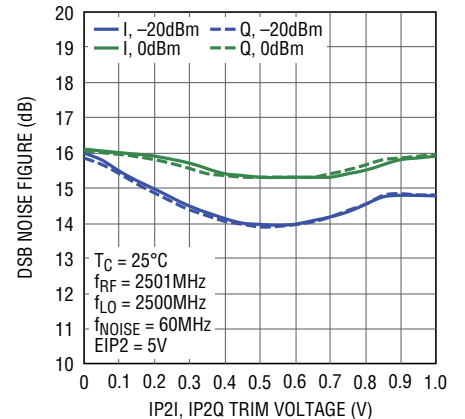

5585 G73

Noise Figure vs RF Input Power

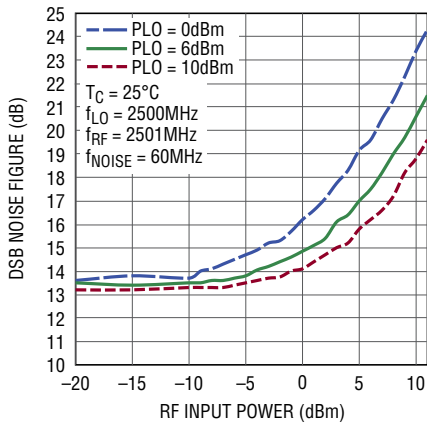

5585 G74

DC Offset vs DCOI, DCOQ Control Voltage

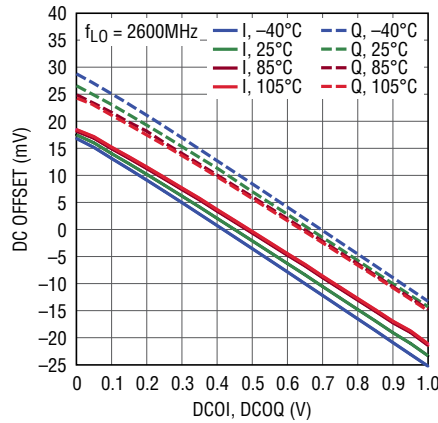

5585 G75

DC Offset vs LO Power

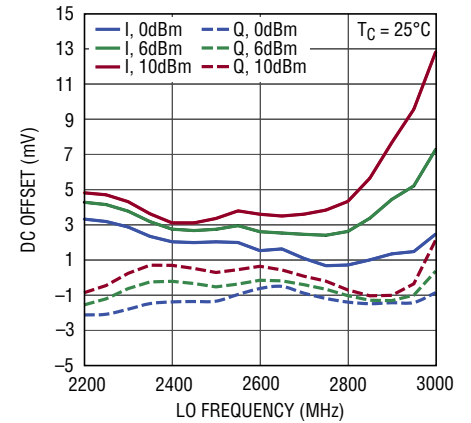

5585 G76

LO to RF Leakage and RF to LO Isolation

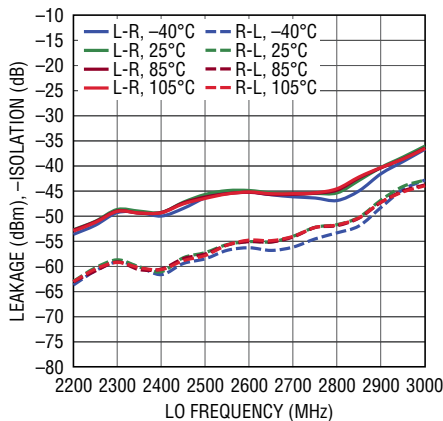

5585 G77

Image Rejection vs Temperature (Note 10)

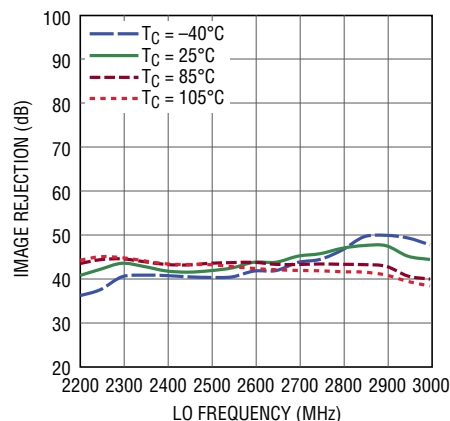

5585 G78

PIN FUNCTIONS

IP2Q, IP2I (Pin 1, Pin 4): IIP2 Adjustment Analog Control Voltage Input for Q and I Channel. A decoupling capacitor is recommended on this pin. A low output resistance voltage source is recommended for driving these pins. These pins should be left floating if unused.

DCOQ, DCOI (Pin 2, Pin 3): DC Offset Analog Control Voltage Input for Q and I Channel. A decoupling capacitor is recommended on this pin. A low output resistance voltage source is recommended for driving these pins. These pins should be left floating if unused.

RF (Pin 5): RF Input. External matching is used to obtain good return loss across the RF input frequency range. The RF pin is internally shorted to ground through internal transformer windings. The RF pin should be DC-blocked with a 1000pF coupling capacitor.

GND (Pins 6, 8, 13, 14, Exposed Pad Pin 25): Ground. These pins must be soldered to the RF ground plane on the circuit board. The backside exposed pad ground connection should have a low inductance connection and good thermal contact to the printed circuit board ground plane using many through-hole vias. See Figures 2 and 3.

EN (Pin 7): Enable Pin. When the voltage on the EN pin is a logic high, the chip is completely turned on; the chip is completely turned off for a logic low. An internal 200k pull-down resistor ensures the chip remains disabled if there is no connection to the pin (open-circuit condition).

V_{BIAS} (Pin 9): This pin can be pulled to ground through a resistor to lower the current consumption of the chip. See Applications Information.

V_{CC} (Pin 10): Positive Supply Pin. This pin should be bypassed with shunt 1000pF and 1μF capacitors.

EDC (Pin 11): DC Offset Adjustment Mode Enable Pin. When the voltage on the EDC pin is a logic high, the DC offset control circuitry is enabled. The circuitry is disabled for a logic low. An internal 200k pull-down resistor ensures the circuitry remains disabled if there is no connection to the pin (open-circuit condition).

EIP2 (Pin 12): IP2 Offset Adjustment Mode Enable Pin. When the voltage on the EIP2 pin is a logic high, the IP2 adjustment circuitry is enabled. The circuitry is disabled for a logic low. An internal 200k pull-down resistor ensures the circuitry remains disabled if there is no connection to the pin (open-circuit condition).

LO⁺, LO⁻ (Pin 15, Pin 16): LO Inputs. External matching is required to obtain good return loss across the LO input frequency range. Can be driven single ended or differentially with an external transformer. The LO pins should be DC-blocked with a 1000pF coupling capacitor.

V_{CAP}, CMQ, CMI (Pin 17, Pin 18, Pin 19): Common Mode Bypass Capacitor Pins. It is recommended that CMI and CMQ be connected to V_{CAP} through 0.1μF capacitors. Nothing else should be connected to V_{CAP} since it is connected to V_{CC} inside the chip.

I⁺, I⁻, Q⁺, Q⁻ (Pin 23, Pin 22, Pin 21, Pin 20): Differential Baseband Output Pins for the I Channel and Q Channel. The DC bias point is V_{CC} – 1.5V for each pin. These pins must have an external 100Ω or an inductor pull-up to V_{CC}.

REF (Pin 24): Voltage Reference Input for Analog Control Voltage Pins. A decoupling capacitor is recommended on this pin. A low output resistance voltage source is recommended for driving this pin. This pin should be left floating if unused.

BLOCK DIAGRAM

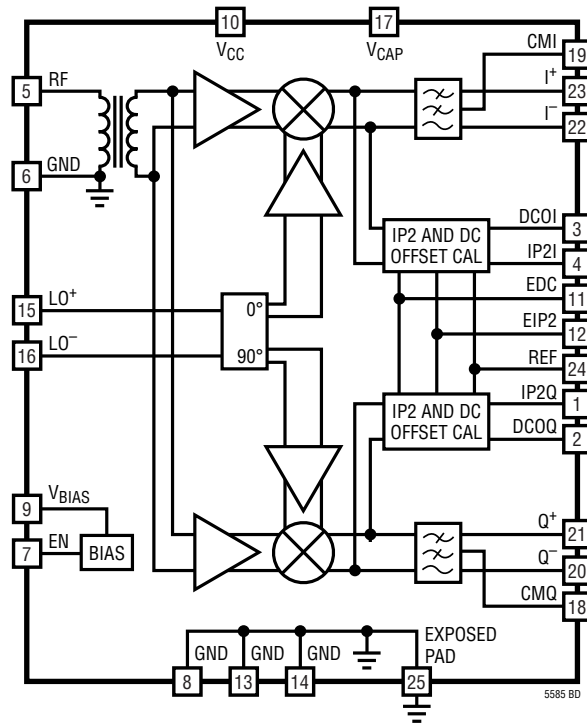

TEST CIRCUIT

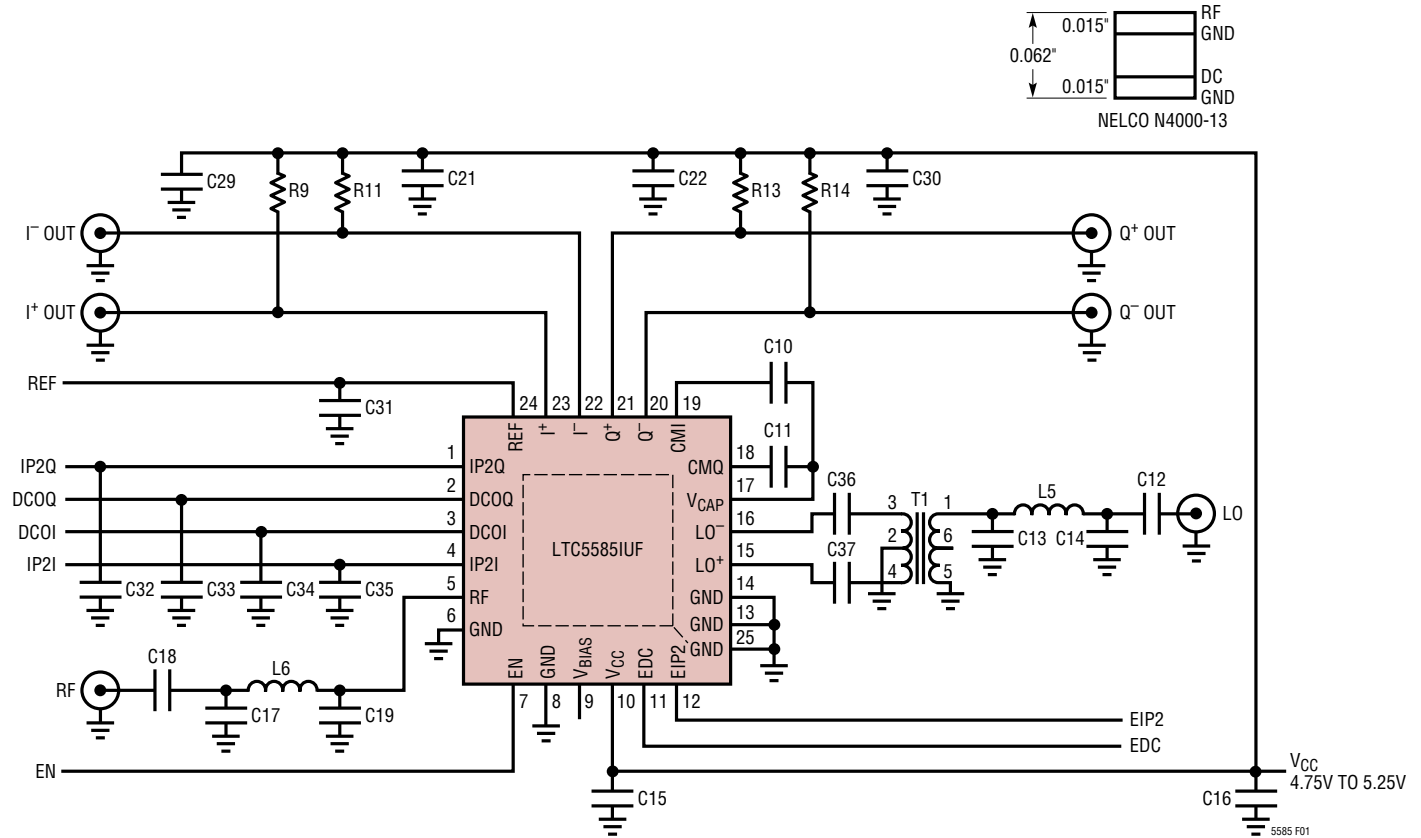

FREQUENCY RANGE	RF MATCH			LO MATCH		
	C17	L6	C19	C13	L5	C14
700MHz		2.7pF	1.0pF		12nH	5.6pF
1950MHz		1.2pF	5.1nH	5.1nH	1.0pF	
2150MHz	1.5pF	4.7nH	0.5pF		5.1nH	0.7pF
2600MHz	0.5pF	2.7nH			1.2nH	1pF

REF DES	VALUE	SIZE	VENDOR	REF DES	VALUE	SIZE	VENDOR
C10, C11, C31-C35	0.1μF	0402	Murata	L5, L6	See Table	0402	Murata
C12, C15, C18, C36, C37	1000pF	0402	Murata	R9, R11, R13, R14	100Ω	0402	Vishay
C13, C14, C17, C19	See Table	0402	Murata	T1	4:1	0805	Anaren BD0826J50200A00
C16, C21, C22, C29, C30	1μF	0402	Murata				

Figure 1. Test Circuit Schematic

TEST CIRCUIT

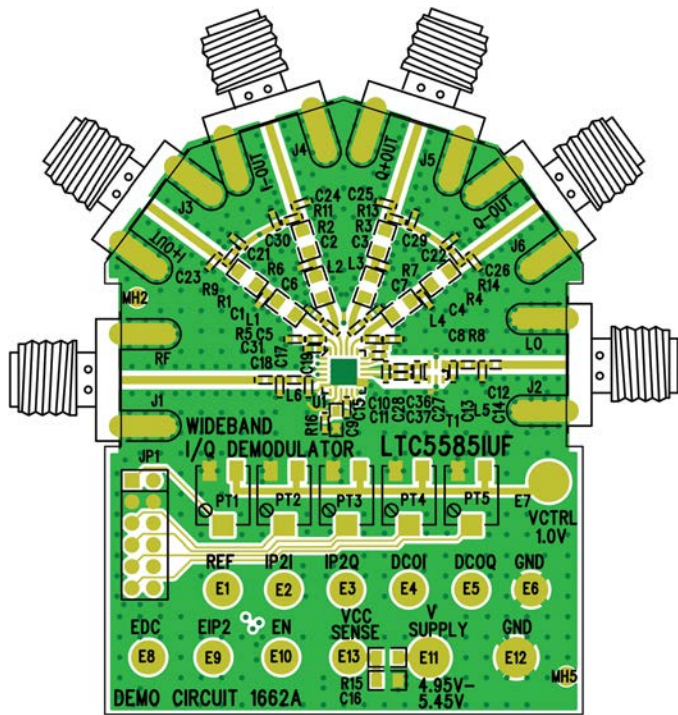

Figure 2. Component Side of Evaluation Board

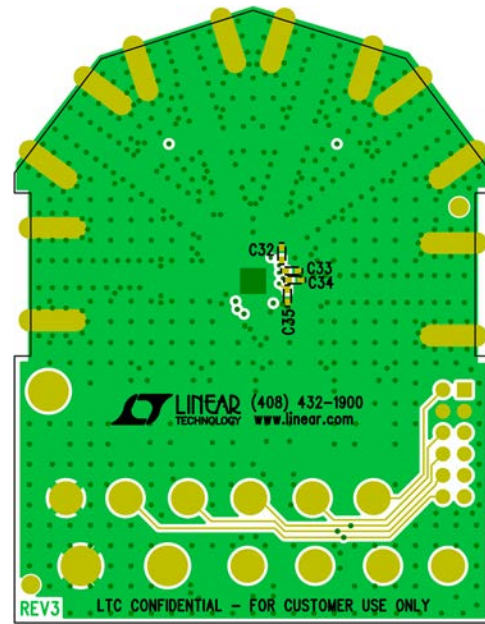

Figure 3. Bottom Side of Evaluation Board

APPLICATIONS INFORMATION

The LTC5585 is an IQ demodulator designed for high dynamic range receiver applications. It consists of RF transconductance amplifiers, I/Q mixers, quadrature LO amplifiers, IIP2 and DC offset correction circuitry, and bias circuitry.

Operation

As shown in the Block Diagram for the LTC5585, the RF signal is applied to the inputs of the RF transconductor V-to-I converters and is then demodulated into I/Q baseband signals using quadrature LO signals which are internally generated by a precision 90° phase shifter. The demodulated I/Q signals are lowpass filtered on-chip with a -3dB bandwidth of 530MHz. The differential outputs of the I-channel and Q-channel are well matched in amplitude and their phases are 90° apart.

RF Input Port

Figure 4 shows the demodulator's RF input which consists of an integrated transformer and high linearity transconductance amplifiers (V-I converters). The primary side of the transformer is connected to the RF input pin. The secondary side of the transformer is connected to the

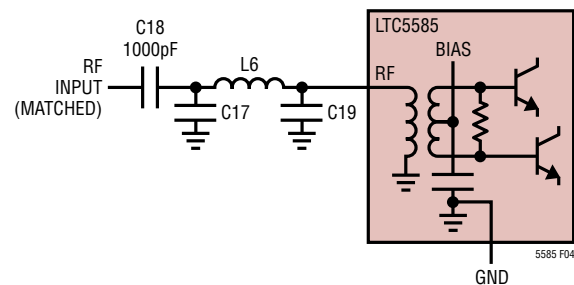

Figure 4: Simplified Schematic of the RF Pin Interface

APPLICATIONS INFORMATION

differential inputs of the transconductance amplifiers. External DC voltage should not be applied to the RF input pin. DC current flowing into the primary side of the transformer may cause damage to the integrated transformer. A series DC blocking capacitor should be used to couple the RF input pin to the RF signal source.

The RF input port can be externally matched over the operating frequency range with simple L-C matching. An input return loss better than 10dB can be obtained over a bandwidth of better than 16% with this method. Figure 5 shows the RF input return loss for various matching component values. Table 1 shows the impedance and input reflection coefficient for the RF input without using any external matching components. The input transmission line length is de-embedded from the measurement.

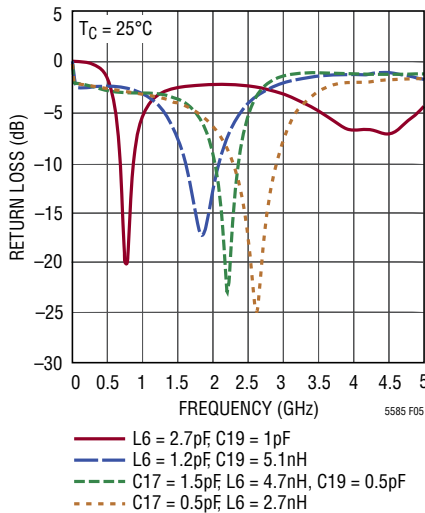

Figure 5. RF Input Return Loss

Larger bandwidths can be obtained by using multiple L-C sections. For example Figure 6 shows a 2-section L-C match having a bandwidth of about 38% where return loss is $>10\text{dB}$. Figure 7 shows the RF input return loss for the wide bandwidth match.

Broadband Performance

To get an idea of the broadband performance of the LTC5585, a 6dB pad can be put on the RF and LO ports, and the ports can be left unmatched. The measured RF performance for this configuration is shown in Figures 8, 9, 10 and 11 with the 6dB pad de-embedded. The RF

Table 1. RF Input Impedance

FREQUENCY (MHz)	INPUT IMPEDANCE (Ω)	S11	
		MAG	ANGLE ($^\circ$)
400	$6.98 + j25.09$	0.800	125.98
600	$10.43 + j39.74$	0.775	101.55
800	$16.76 + j56.73$	0.751	80.01
1000	$28.55 + j77.15$	0.727	61.05
1200	$51.47 + j101.03$	0.706	44.29
1400	$96.49 + j122.28$	0.686	29.33
1600	$171.91 + j112.37$	0.667	15.81
1800	$229.92 + j30.89$	0.648	3.45
2000	$202.21 - j58.84$	0.630	-8.00
2200	$145.32 - j91.23$	0.612	-18.71
2400	$104.82 - j91.69$	0.594	-28.49
2600	$78.33 - j83.38$	0.575	-38.22
2800	$61.86 - j73.64$	0.557	-47.49
3000	$51.27 - j64.65$	0.538	-56.32
3200	$43.83 - j56.56$	0.519	-65.15
3400	$38.86 - j49.72$	0.500	-73.40
3600	$35.17 - j43.6$	0.481	-81.68
3800	$32.46 - j38.21$	0.463	-89.79
4000	$30.48 - j33.41$	0.444	-97.76

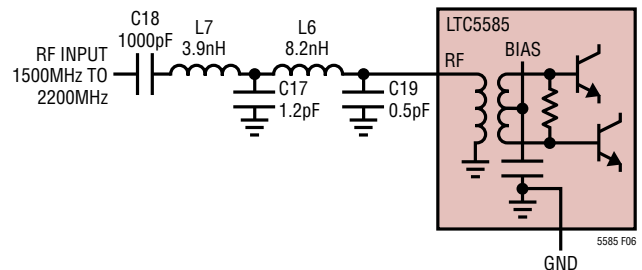

Figure 6. Wide Bandwidth RF Input Match

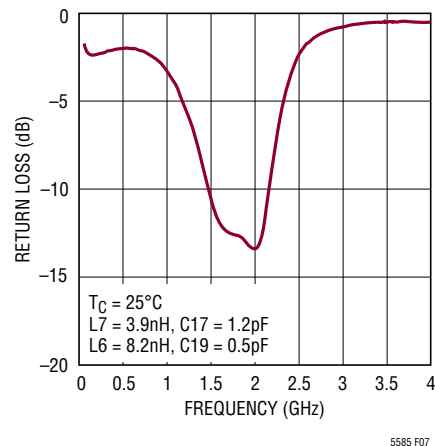
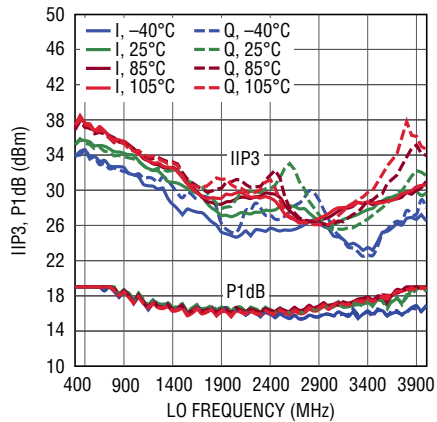

Figure 7. RF Input Return Loss for Wideband Match

APPLICATIONS INFORMATION



5585 F08

Figure 8. Broadband IIP3 and IP1dB

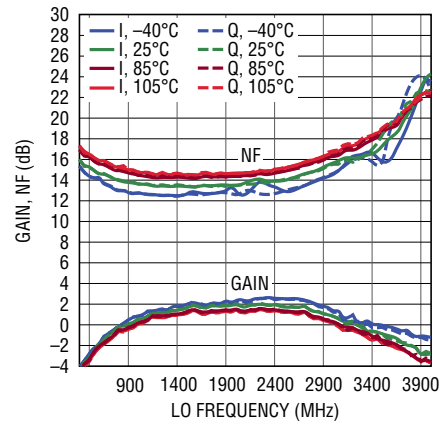

5585 F10

Figure 10. Broadband NF and Gain

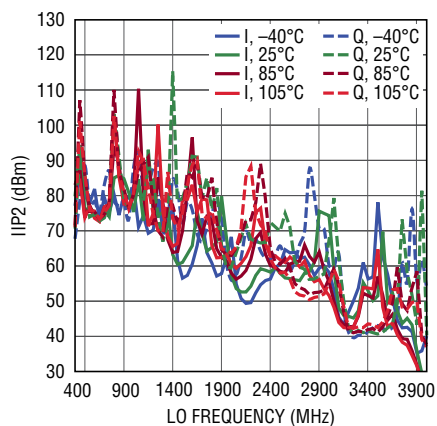

5585 F09

Figure 9. Broadband IIP2

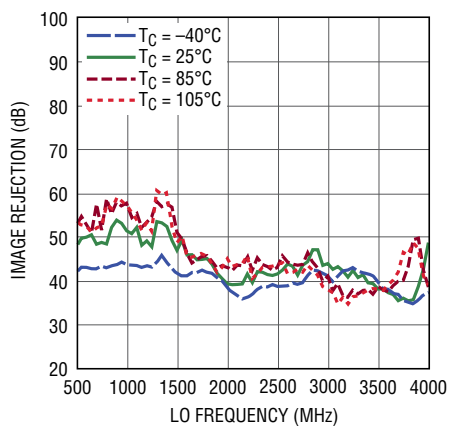

5585 F11

Figure 11. Broadband Image Rejection

tone spacing is 1MHz, and f_{LO} is 10MHz lower than f_{RF} . The conversion gain is lower than under the impedance matched condition, and correspondingly the P1dB, IIP3, and NF are higher. As shown, the part can be used at frequencies outside its specified operating range with reduced conversion gain and higher NF.

LO Input Port

The demodulator's LO input interface is shown in Figure 12. The input consists of a high precision quadrature phase shifter which generates 0° and 90° phase shifted LO signals for the LO buffer amplifiers to drive the I/Q mixers. DC blocking capacitors are required on the LO^+ and LO^- inputs.

The differential LO input impedance and S parameters with the input transmission lines and balun de-embedded are listed in Table 2.

Figure 13 shows LO input return loss using the ANAREN BD0826J50200A00 4:1 balun with various matching component values.

For optimum IIP2 and large-signal NF performance the LO inputs should be driven differentially with a 4:1 balun such as the ANAREN BD0826J50200A00 or BD2425J50200AHF. As shown in Figure 14, the LO input can also be driven single-ended from either the LO^+ or LO^- input. The unused port should be DC-blocked and terminated with a 50Ω load. Figure 15 compares the uncalibrated IIP2 performance of single ended versus differential LO drive.

5585fb

APPLICATIONS INFORMATION

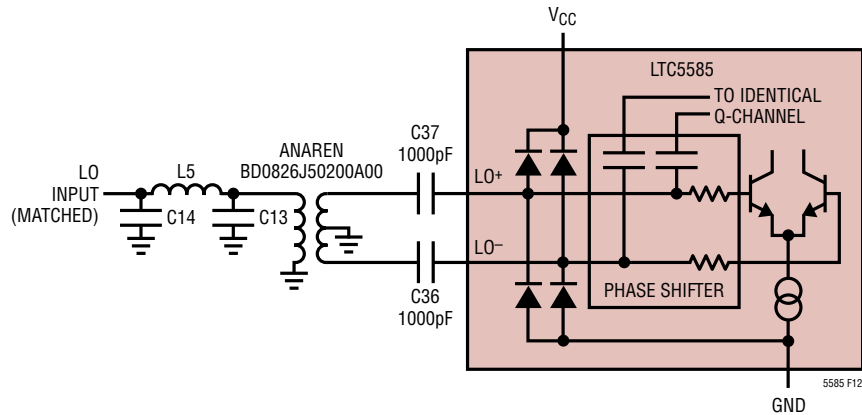

Figure 12. Simplified Schematic of LO Input Interface with External Matching Components

Table 2. LO Input Impedance (Differential)

FREQUENCY (MHz)	INPUT IMPEDANCE (Ω)	S11	
		MAG	ANGLE ($^\circ$)
400	118.18 – j120.02	0.668	-24.89
600	94.18 – j99.93	0.623	-31.42
800	78.00 – j85.06	0.583	-38.17
1000	67.21 – j73.16	0.544	-44.79
1200	59.71 – j63.49	0.507	-51.25
1400	54.22 – j55.46	0.471	-57.63
1600	50.06 – j48.59	0.437	-64.02
1800	46.80 – j42.69	0.405	-70.49
2000	44.10 – j37.42	0.374	-77.28
2200	41.86 – j32.61	0.345	-84.47
2400	39.98 – j28.16	0.317	-92.21
2600	38.39 – j23.98	0.291	-100.65
2800	37.05 – j20.01	0.267	-109.95
3000	35.92 – j16.21	0.246	-120.29
3200	34.99 – j12.53	0.228	-131.76
3400	34.22 – j8.95	0.214	-144.37
3600	33.61 – j5.45	0.206	-157.88
3800	33.15 – j2.0	0.204	-171.85
4000	32.82 + j1.4	0.208	174.35

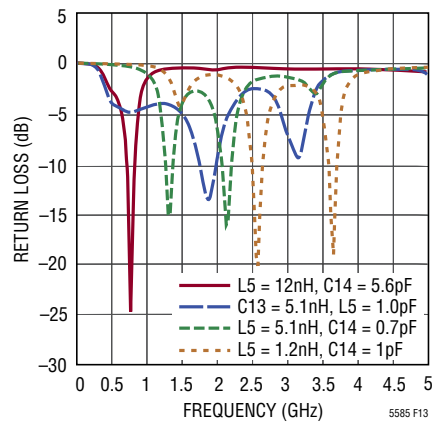

Figure 13. LO Input Return Loss

APPLICATIONS INFORMATION

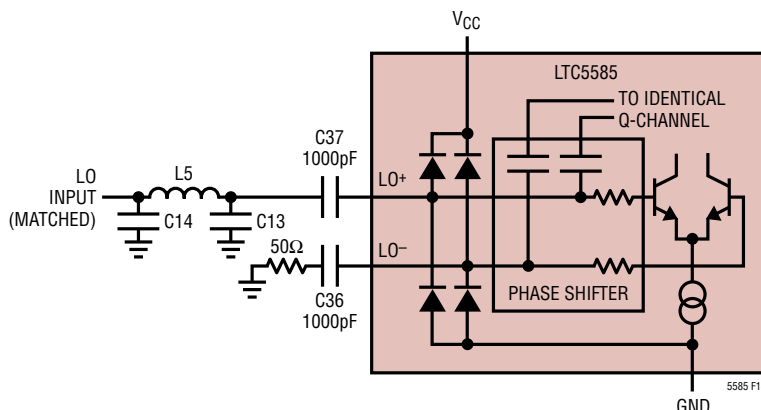

Figure 14. Recommended Single-Ended LO Input Configuration

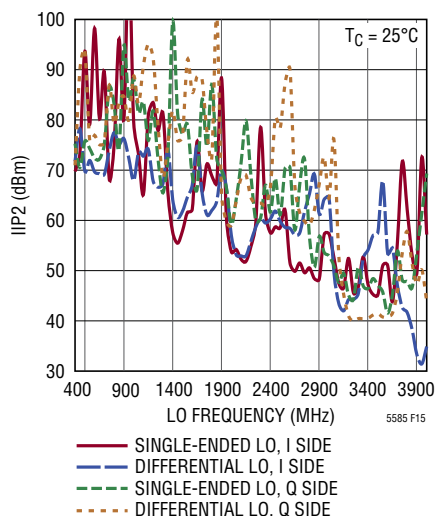

Figure 15. Broadband IIP2 with Differential and Single-Ended LO Drive

I-Channel and Q-Channel Outputs

The phase relationship between the I-channel output signal and the Q-channel output signal is fixed. When the LO input frequency is higher (or lower) than the RF input frequency, the Q-channel outputs (Q^+ , Q^-) lag (or lead) the I-channel outputs (I^+ , I^-) by 90° .

Each of the I-channel and Q-channel outputs is internally connected to V_{CC} through a 100Ω resistor. In order to maintain an output DC bias voltage of $V_{CC} - 1.5V$, external 100Ω pull-up resistors or equivalent $15mA$ DC

current sources are required. Each single-ended output has an impedance of 100Ω in parallel with a $6pF$ internal capacitor. With an external 100Ω pull-up resistor this forms a lowpass filter with a $-3dB$ corner frequency at $530MHz$. The outputs can be DC coupled or AC coupled to external loads. The voltage conversion gain is reduced by the external load by:

$$20\text{Log}_{10}\left(\frac{1}{2} + \frac{50\Omega}{R_{\text{PULL-UP}} \parallel R_{\text{LOAD(SE)}}}\right) \text{ dB}$$

when the output port is terminated by $R_{\text{LOAD(SE)}}$. For instance, the gain is reduced by $6dB$ when each output pin is connected to a 50Ω load (or 100Ω differentially). The output should be taken differentially (or by using differential-to-single-ended conversion) for best RF performance, including NF and IIP2. When no external filtering or matching components are used, the output response is determined by the loading capacitance and the total resistance loading the outputs. The $-3dB$ corner frequency, f_C , is given by the following equation:

$$f_C = [2\pi(R_{\text{LOAD(SE)}} \parallel 100\Omega \parallel R_{\text{PULL-UP}}) (6pF)]^{-1}$$

Figure 16 shows the actual measured output response with various load resistances.

Figure 17 shows a simplified model of the I, Q outputs with a 100Ω differential load and 100Ω pull-ups. The $-1dB$ bandwidth in this configuration is about $520MHz$, or about twice the $-1dB$ bandwidth with no load.

APPLICATIONS INFORMATION

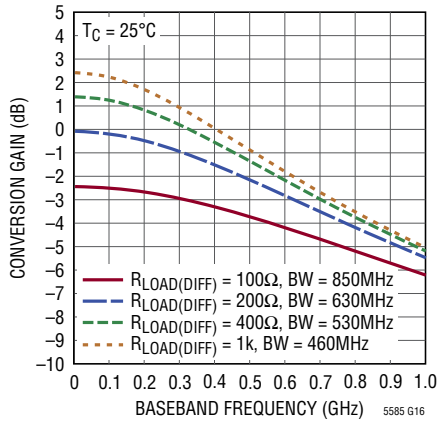

Figure 16. Conversion Gain Baseband Output Response with $R_{LOAD(DIFF)} = 100\Omega, 200\Omega, 400\Omega$ and $1k$ and $R_{PULL-UP} = 100\Omega$

Figure 18 shows a simplified model of the I, Q outputs with a L-C matching network for bandwidth extension. Capacitor C_S serves to filter common mode LO switching noise immediately at the demodulator outputs. Capacitor C_C in combination with inductor L_S is used to peak the output response to give greater bandwidth of 650MHz. In this case, capacitor C_C was chosen as a common mode capacitor instead of a differential mode capacitor to increase rejection of common mode LO switching noise.

When AC output coupling is used, the resulting highpass filter's $-3dB$ roll-off frequency, f_c , is defined by the R-C constant of the external AC coupling capacitance, C_{AC} , and the differential load resistance, $R_{LOAD(DIFF)}$:

$$f_c = [2\pi \cdot R_{LOAD(DIFF)} \cdot C_{AC}]^{-1}$$

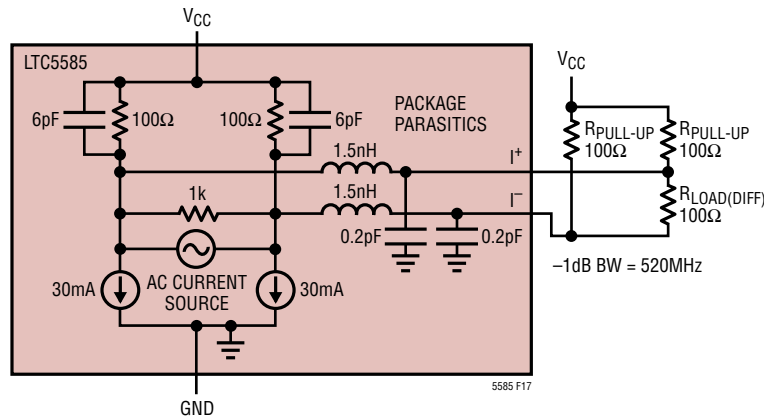

Figure 17. Simplified Model of the Baseband Output

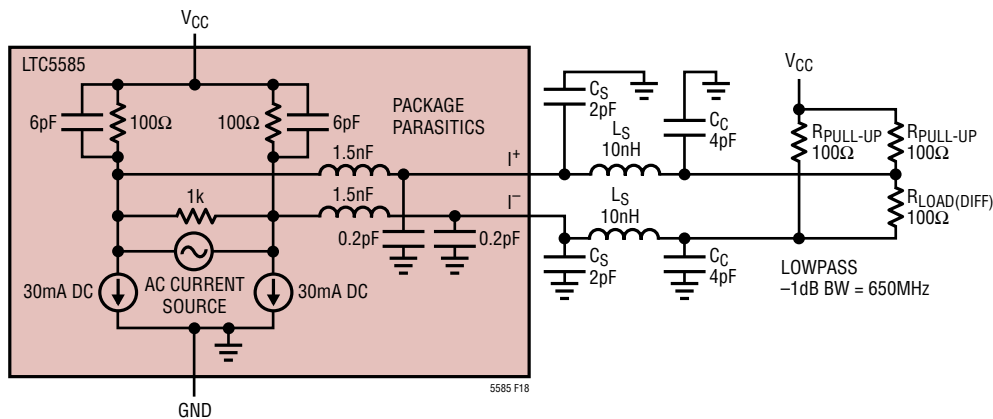

Figure 18. Simplified Model of the Baseband Output Showing Bandwidth Extension with External L, C Matching

APPLICATIONS INFORMATION

Care should be taken when the demodulator's outputs are DC coupled to the external load to make sure that the I/Q mixers are biased properly. If the current drain from the outputs exceeds about 6mA, there can be significant degradation of the linearity performance. Keeping the common mode output voltage of the demodulator above 3.15V, with a 5V supply, will ensure optimum performance. Each output can sink no more than 30mA when the outputs are connected to an external load with a DC voltage higher than $V_{CC} - 1.5V$.

In order to achieve the best IIP2 performance, it is important to minimize high frequency coupling among the baseband outputs, RF port, and LO port. Although it may increase layout complexity, routing the baseband output traces on the backside of the PCB can improve uncalibrated IIP2 performance. Figure 19 shows the alternate layout having the baseband outputs on the backside of the PCB.

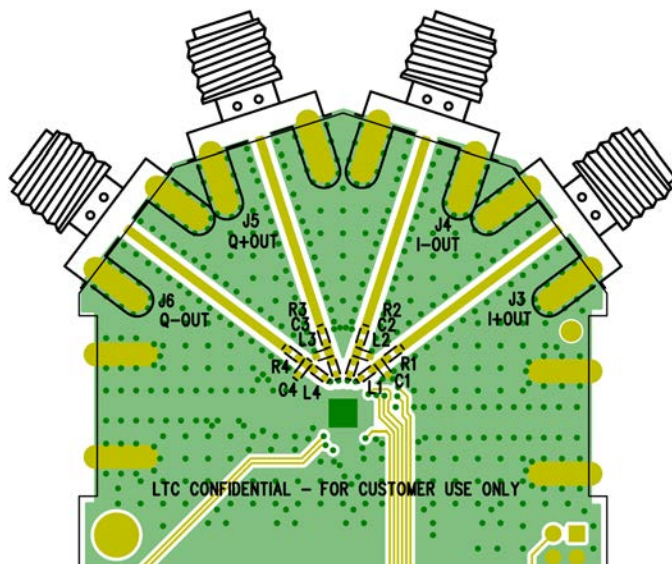

Figure 19. Alternate Layout of PCB with Baseband Outputs on the Backside

Analog Control Voltage Pins

Figure 20 shows the equivalent circuit for the DCOI, DCOQ, IP2I, and IP2Q pins. Internal temperature compensated 62.5 μ A current sources keep these pins biased at a nominal 500mV through 8k resistors. A low impedance voltage source with a source resistance of less than 200 Ω is recommended to drive these pins.

As shown in Figure 21, the REF pin is similar to the DCOI pin, but the bias current source is 250 μ A, and the internal resistance is 2k. If this pin is left disconnected, it will self-bias to 500mV. A low impedance voltage source with a source resistance of less than 200 Ω is recommended to drive this pin. The control voltage range of the DCOI, DCOQ, IP2I and IP2Q pins is set by the REF pin. This range is equal to 0V to twice the voltage on the REF pin, whether internally or externally applied.

It is recommended to decouple any AC noise present on the signal lines that connect to the analog control-voltage inputs. A shunt capacitor to ground placed close to these pins can provide adequate filtering. For instance, a value of 1000pF on the DCOI, DCOQ, IP2I and IP2Q pins will provide a corner frequency of around 6 to 7MHz. A similar corner frequency can be obtained on the REF pin with a value of 3900pF. Using larger capacitance values such as 0.1 μ F is recommended on these pins unless a faster control

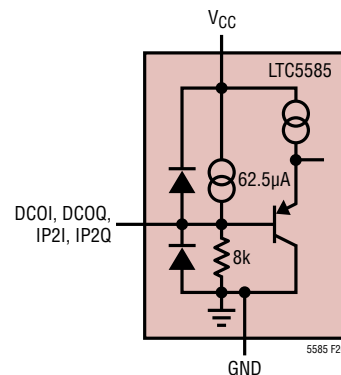

Figure 20. Simplified Schematic of the Interface for the DCOI, DCOQ, IP2I and IP2Q Pins

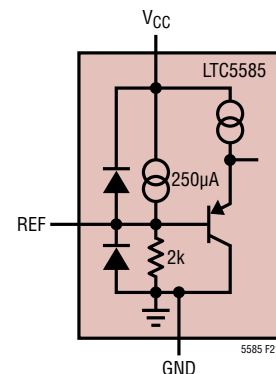

Figure 21. Simplified Schematic of the REF Pin Interface

5585fb

APPLICATIONS INFORMATION

response is needed. Figure 22 shows the input response -3dB bandwidth for the pins versus shunt capacitance when driven from a 50Ω source.

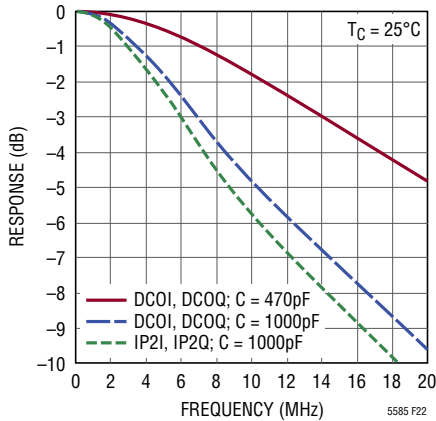

Figure 22. Input Response Bandwidth for the DCOI, DCOQ, IP2I and IP2Q Pins

DC Offset Adjustment Circuitry

Any sources of LO leakage to the RF input of a direct conversion receiver will contribute to the DC offsets of its baseband outputs. The LTC5585 features DC offset adjustment circuitry to reduce such effects. When the EDC pin is a logic high the circuitry is enabled and the resulting DC offset adjustment range is typically $\pm 20\text{mV}$. In a typical direct conversion receiver application, DC offset calibration will be done periodically at a time when no receive data is present and when the receiver DC levels have sufficiently settled.

DC Offset Adjustment Example

Figure 23 shows a typical direct conversion receive path having a DSP feedback path for DC offset adjustment. Any sources of LO leakage to the RF input of the LTC5585 demodulator will contribute to the DC offset of the receiver. This includes both static and dynamic DC offsets. If the coupling is static in nature due to fixed board-level leakage paths, the resulting DC offset does not typically need to be adjusted at a high repetition rate. Dynamic DC offsets due to transmitter transient leakage or antenna reflection can be much harder to correct for and will require a faster update rate from the DSP.

LO leakage into the RF port of the demodulator causes a DC offset at the baseband outputs which is then multiplied by the gain in the baseband path. The usable ADC voltage window will be reduced by the amplified DC offset, resulting in lower dynamic range. Using DSP, this DC offset value can be averaged and sampled at a given update rate and then a 1D minimization algorithm can be applied before a new DCOI or DCOQ control signal is generated to minimize the offset. The 1-D minimization algorithm can be implemented in many ways such as golden-section search, backtracking, or Newton's method.

IM2 Adjustment Circuitry

The LTC5585 also contains circuitry for the independent adjustment of IM2 levels on the I and Q channels. When the EIP2 pin is a logic high, this circuitry is enabled and the IP2I and IP2Q analog control voltage inputs are able

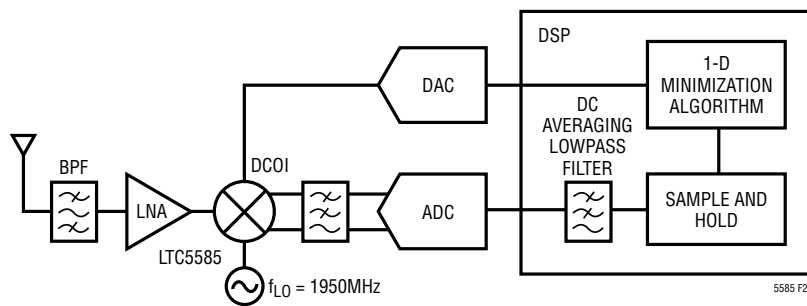

Figure 23. Block Diagram of a Receiver with a DSP Feedback Loop for DC Offset Adjustment

APPLICATIONS INFORMATION

to adjust the IM2 level. The IM2 level can be effectively minimized over a large range of the baseband bandwidth. The circuitry has an effective baseband frequency upper limit of about 200MHz. Any IM2 component that falls in this frequency range can be minimized. Beyond this frequency, the gain of the IM2 correction amplifier falls off appreciably and the circuit no longer improves IP2 performance. The lower baseband frequency limit of the IM2 adjustment circuitry is set by the common mode reference decoupling capacitor at the CMI and CMQ pins. Below this frequency the circuit can not minimize the IM2 component.

Figure 24 shows the CMI (and identical CMQ) pin interface. These pins have an internal 40pF decoupling capacitance to V_{CC} , to provide a reference for the IP2 adjustment circuitry. The lower 3dB frequency limit, f_C , of the circuitry is set by the following equation:

$$f_C = [2\pi \cdot 500(40\text{pF} + C_{CM(EXT)})]^{-1}$$

Without any external capacitor on the CMI or CMQ pin the lower limit is 8MHz. By adding a 0.1 μF capacitor, $C_{CM(EXT)}$, between the CMI and CMQ pins to V_{CAP} , the lower -3dB frequency corner can be reduced to 3kHz. Figure 25 shows IIP2 as a function of RF frequency spacing versus common mode decoupling capacitance values of 0.1 μF and 1500pF. There is effectively no limit on the size of this capacitor, other than the impact it has on enable time for the IM2 circuitry to be operational. When the chip is disabled, there is no current in the I or Q mixers, so the common mode

output voltage will be equal to V_{CC} (if no DC common mode current is being drawn by external baseband circuitry such as a baseband amplifier). When the chip is enabled, the off-chip common mode decoupling capacitor must charge up through a 500 Ω resistor. The time constant for this is essentially 500 Ω times the common mode decoupling capacitance value. For example, with a 0.01 μF capacitor this wait time is approximately 30 μs . Figure 26 shows the pulsed enable response of the common-mode output voltage with 0.01 μF on the CMI and CMQ pins.

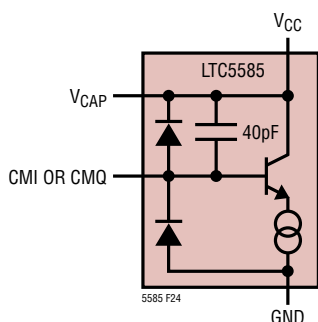

Figure 24. Equivalent Circuit of the CMI and CMQ Pin Interfaces

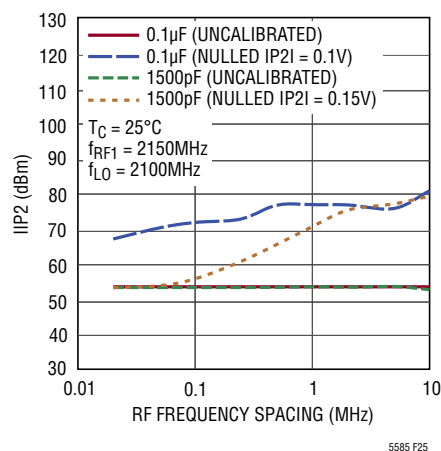

Figure 25. IIP2 vs Common Mode Decoupling Capacitance

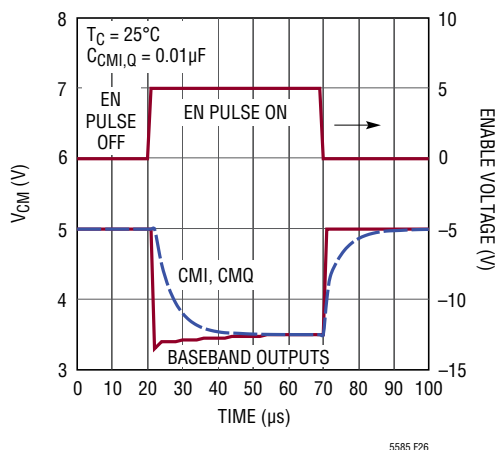

Figure 26. Common Mode Output Voltage with a Pulsed Enable

APPLICATIONS INFORMATION

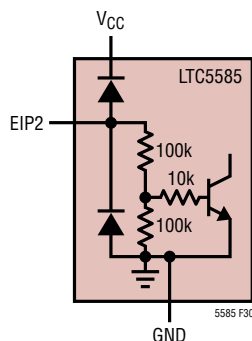

Figure 30. Simplified Schematic of the EIP2 Pin Interface

It is important that the voltage applied to the EN, EDC and EIP2 pins should never exceed V_{CC} by more than 0.3V. Otherwise, the supply current may be sourced through the upper ESD protection diode connected at the pin. Under no circumstances should voltage be applied to the enable pins before the supply voltage is applied to the V_{CC} pin. If this occurs, damage to the IC may result.

Reducing Power Consumption

Figure 31 shows the simplified schematic of the V_{BIAS} interface. The V_{BIAS} pin can be used to lower the mixer core bias current and total power consumption for the chip. For example, adding 294 Ω from the V_{BIAS} pin to GND will lower the DC current to 150mA, at the expense of reduced IIP3 performance. Figure 32 shows IIP3 and P1dB performance versus DC current and resistor value. An optional capacitor, C_{OPT} in Figure 31, has minimal effect on improving PSRR and IIP2.

1950MHz Receiver Application

Figure 33 shows a typical receiver application consisting of the chain of LNA, demodulator, lowpass filter, ADC driver, and ADC. Total DC power consumption is about 2.1W. Full-scale power at the RF input is -6dBm. The Chebychev lowpass filter with unequal terminations is designed using the method shown in the appendix. Filter component values are then adjusted for the best overall response

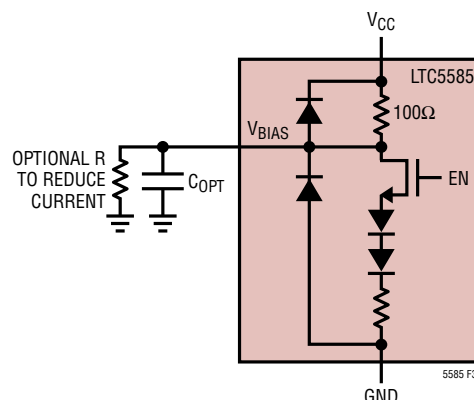

Figure 31. Simplified Schematic of the V_{BIAS} Pin Interface

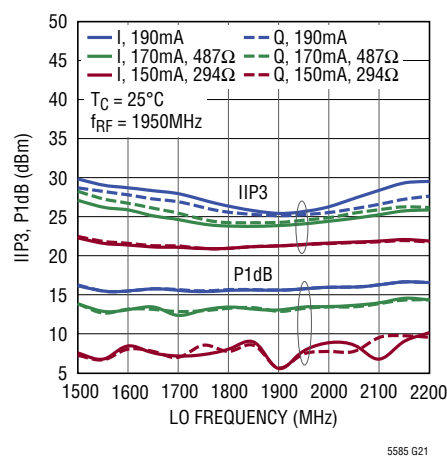

Figure 32. IIP3 and P1dB vs DC Current and V_{BIAS} Resistor Value

and available component values. A positive voltage gain slope with frequency is necessary to compensate for the roll-off contributed by the ADC Driver and Anti-Alias Filter. From the chain analysis shown in Figure 34, the IIP3-NF dynamic range figure of merit (FOM) is 4.3dB at the LNA input, 7.5dB at the demodulator input, and 14.85dB at the ADC driver amp input.

The measured 6th order lowpass baseband response is shown in Figure 35.

APPLICATIONS INFORMATION

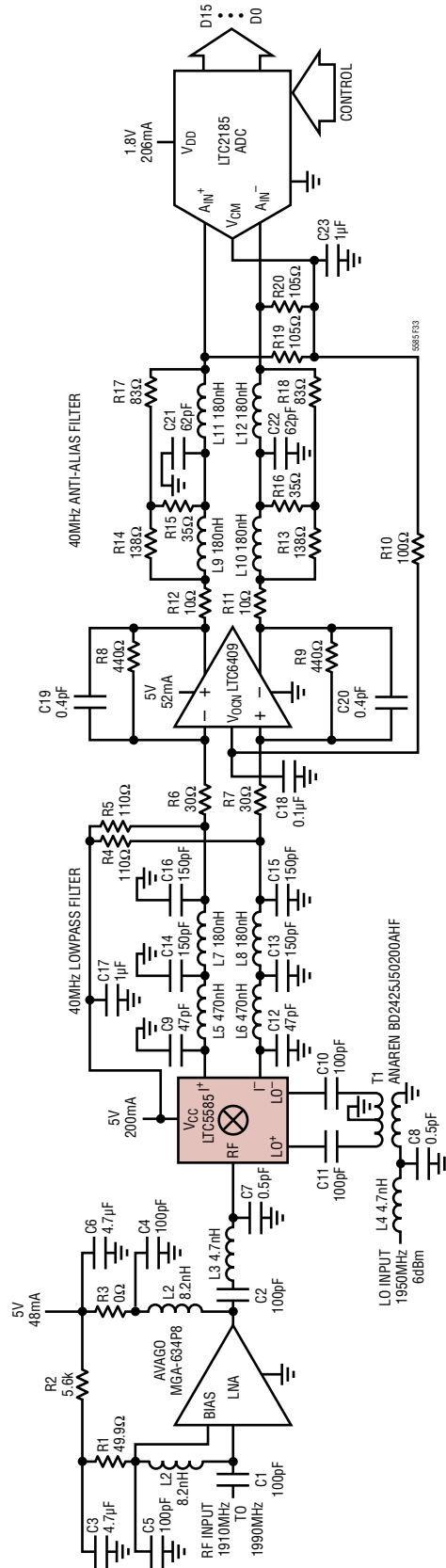

Figure 33. Simplified Schematic of 1950MHz Receiver, (Only I-Channel Is Shown)

APPLICATIONS INFORMATION

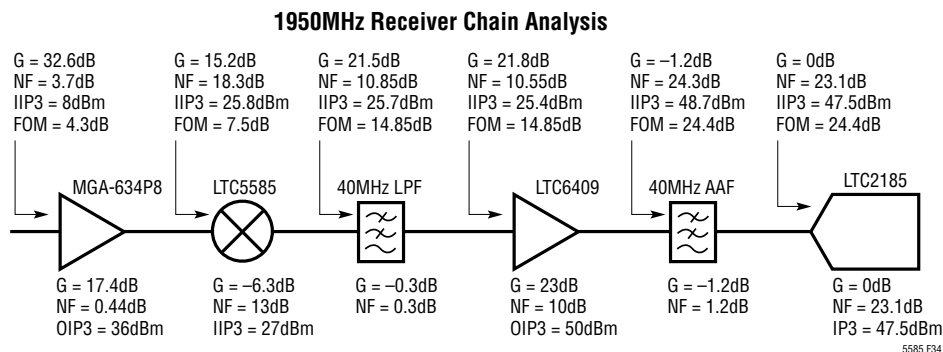

Figure 34. 1950MHz Receiver Chain Analysis

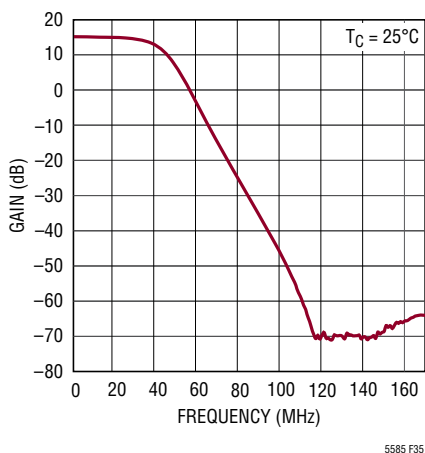

Figure 35. Baseband Gain Response without LNA

The receiver spurious free dynamic range (SFDR) in terms of FOM can be calculated using the following equations:

$$FOM = IIP3 - NF$$

$$SFDR = 2/3(FOM - P_0)$$

$$P_0 = -174dBm + 10\text{Log}_{10}(BW|_{Hz})$$

where P_0 is the input noise power and $-174dBm$ is the input thermal noise power in a 1Hz bandwidth. A measured 2-tone output spectrum at 1910MHz is shown in Figure 36. IIP3 is calculated from the 2-tone IM3 levels:

$$IIP3 = (-7.067 - (-76.63))/2 - 13$$

$$IIP3 = 21.78dBm$$

For this example, receiver noise floor is approximated by a measurement at 845MHz, where adequate filtering for RF and LO signals was possible. Using the test data from Figure 37, the receiver noise figure for the I-channel (Ch 1) is calculated using the $-6dBm$ input power, 1875Hz bin width, 40MHz bandwidth, and $-116.3dBFS$ measured in-band noise floor:

$$SNR_{IN} = P_{IN} - P_0$$

$$SNR_{IN} = -6 - (-174 + 76) = 92dB$$

$$SNR_{OUT} = -10 \text{Log}_{10}(\text{BinW}/BW) - \text{Floor}$$

$$SNR_{OUT} = -43.3 + 116.3 = 73dB$$

$$NF = SNR_{IN} - SNR_{OUT}$$

$$NF = 92 - 73 = 19dB$$

Finally, an approximate receiver spurious free dynamic range can be calculated using the measured data at 845MHz and 1910MHz:

$$SFDR = 2(IIP3 - NF - P_0)/3$$

$$SFDR = 2(21.78 - 19 - (-174 + 76))/3$$

$$SFDR = 67.2dB \text{ (I-channel)}$$

Measured IIP3 is 2.3dB higher for the Q-channel, so the resulting SFDR is:

$$SFDR = 68.7dB \text{ (Q-channel)}$$

APPLICATIONS INFORMATION

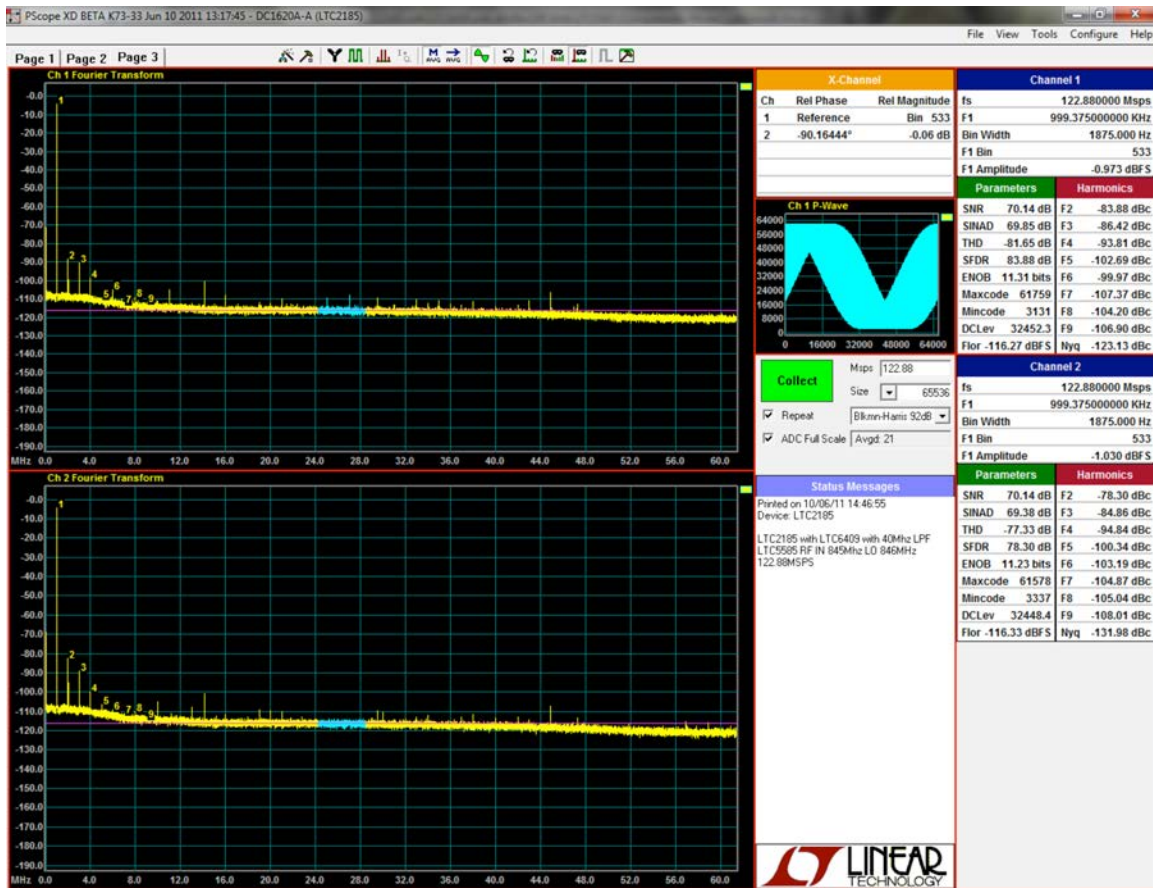

Figure 37. $f_{RF} = 845\text{MHz}$ Receiver Noise Floor Test, $f_{LO} = 846\text{MHz}$. Ch.1 Is the I-Channel and Ch.2 Is the Q-Channel. Tested without LNA

APPENDIX

Chebyshev Filter Synthesis with Unequal Terminations

To synthesize Chebyshev filters with unequal terminations, two equally terminated filters are synthesized at the two different impedance levels and the resulting networks are joined using the Impedance Bisection Theorem[1]. This method only works with symmetrical odd-order filters. The general lowpass prototype element values are generated by the method shown [2]:

$$\beta = \ln \left[\coth \frac{L_{Ar}|_{dB}}{17.37} \right]$$

$$\gamma = \sinh \left(\frac{\beta}{2n} \right)$$

$$a_k = \sin \frac{\pi(2k-1)}{2n}, k = 1, 2, \dots, n$$

$$b_k = \gamma^2 + \sin^2 \frac{\pi k}{n}, k = 1, 2, \dots, n$$

where $L_{Ar}|_{dB}$ is the passband ripple in dB, and n is the filter order.

The prototype element values will be:

$$g_1 = \frac{2a_1}{\gamma}$$

$$g_k = \frac{4a_k a_{k-1}}{b_{k-1} g_{k-1}}, k = 1, 2, \dots, n$$

$$g_{n+1} = 1 \text{ for } n \text{ odd}$$

$$g_{n+1} = \coth^2 \left(\frac{\beta}{4} \right) \text{ for } n \text{ even}$$

Assuming the first element is a capacitor, we can scale the filter capacitor prototype values up to our desired cutoff frequency f_C :

$$C_k = \frac{g_k}{2\pi \cdot f_C \cdot R_{IN}}, k = 1, 3, \dots, n$$

The filter inductor values can be scaled with:

$$L_k = \frac{g_k \cdot R_{IN}}{2\pi \cdot f_C}, k = 2, 4, \dots, n$$

where R_{IN} is the input impedance and the terminating impedance R_{OUT} is equal to R_{IN} for the n odd case but is scaled by the g_{n+1} prototype value for the n even case.

The Impedance Bisection Theorem can be applied to symmetrical networks by dividing the element values along the networks' plane of symmetry, and then adding the two networks together. The filter response is preserved.

For example, if $L_{Ar}|_{dB} = 0.2\text{dB}$, $f_C = 40\text{MHz}$, $R_{IN} = 100\Omega$, $R_{OUT} = 20\Omega$ and $n = 5$, the prototype element values and resulting scaled filter values are listed:

Filter 1: $R_{IN} = R_{OUT} = 100\Omega$

$$g_1 = 1.339 \rightarrow C1 = 53.3\text{pF}$$

$$g_2 = 1.337 \rightarrow L1 = 531.98\text{nH}$$

$$g_3 = 2.166 \rightarrow C2 = 86.19\text{pF}$$

$$g_4 = 1.337 \rightarrow L2 = 531.98\text{nH}$$

$$g_5 = 1.339 \rightarrow C3 = 53.3\text{pF}$$

Filter 2: $R_{IN} = R_{OUT} = 20\Omega$

$$g_1 = 1.339 \rightarrow C1 = 266.48\text{pF}$$

$$g_2 = 1.337 \rightarrow L1 = 106.4\text{nH}$$

$$g_3 = 2.166 \rightarrow C2 = 430.93\text{pF}$$

$$g_4 = 1.337 \rightarrow L2 = 106.4\text{nH}$$

$$g_5 = 1.339 \rightarrow C3 = 266.48\text{pF}$$

The Impedance Bisection Theorem can be applied at the plane of symmetry about $C2$ such that a new value of $C2$ can be computed with half the values of the two filters.

$$C2 \rightarrow \frac{86.19\text{pF}}{2} + \frac{430.93\text{pF}}{2} = 258.56\text{pF}$$

The final unequally-terminated filter design values are shown in Figure 38.

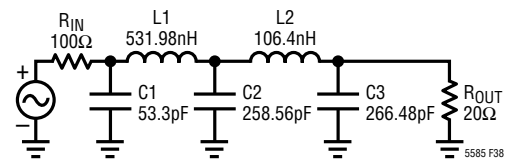

Figure 38. Final Design Schematic

[1] A.C. Bartlett, "An Extension of a Property of Artificial Lines," Phil. Mag., vol.4, p.902, November 1927.

[2] G. Matthaei, L. Young, and E.M.T. Jones, Microwave Filters, Impedance-Matching Networks, and Coupling Structures, p.99, 1964.

APPENDIX

Image Rejection Calculation

Image rejection can be calculated from the measured gain and phase error responses of the demodulator. Consider the signal diagram of Figure 39:

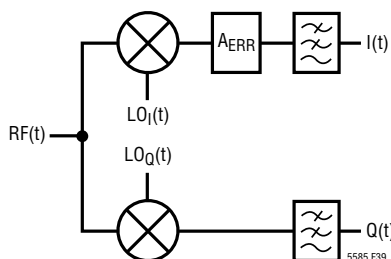

Figure 39. Signal Diagram for a Demodulator

where:

$$RF(t) = \sin(\omega_{LO} + \omega_{BB})t + \sin(\omega_{LO} - \omega_{IM})t$$

$$LO_I(t) = \cos(\omega_{LO}t + \phi_{ERR})$$

$$LO_Q(t) = \sin(\omega_{LO}t)$$

$\omega_{LO} + \omega_{BB}$ is the desired sideband frequency and $\omega_{LO} - \omega_{IM}$ is the image frequency. The total phase error of the I and Q channels is lumped into the I-channel LO source as ϕ_{ERR} . The total gain error is represented by A_{ERR} , and is lumped into a gain multiplier in the I-channel.

After lowpass filtering the I and Q signals can be written as:

$$I(t) = \frac{A_{ERR}}{2} [\sin(\omega_{BB}t - \phi_{ERR}) - \sin(\omega_{IM}t + \phi_{ERR})]$$

$$Q(t) = \frac{1}{2} [\cos(\omega_{BB}t) + \cos(\omega_{IM}t)]$$

Shifting the Q channel by -90° can be accomplished by replacing sine with cosine such that the shifted Q-channel signal is:

$$Q_{-90}(t) = \frac{1}{2} [\sin(\omega_{BB}t) + \sin(\omega_{IM}t)]$$

We combine $I(t) + Q_{-90}(t)$ and choose terms containing ω_{BB} as the desired signal:

$$\text{desired} = \frac{1}{2} \sin(\omega_{BB}t) + \frac{A_{ERR}}{2} \sin(\omega_{BB}t - \phi_{ERR})$$

Similarly, we choose terms containing ω_{IM} as the image signal:

$$\text{image} = \frac{1}{2} \sin(\omega_{IM}t) - \frac{A_{ERR}}{2} \sin(\omega_{IM}t + \phi_{ERR})$$

The image rejection ratio (IRR) can then be written as:

$$IRR_{dB} = 10 \log \frac{|\text{desired}|^2}{|\text{image}|^2}$$

Written in terms of A_{ERR} and ϕ_{ERR} as:

$$IRR_{dB} = 10 \log \frac{|1 + A_{ERR}^2 + 2A_{ERR} \cos(\phi_{ERR})|}{|1 + A_{ERR}^2 - 2A_{ERR} \cos(\phi_{ERR})|}$$

Figure 40 shows image rejection as a function of amplitude and phase errors for a demodulator.

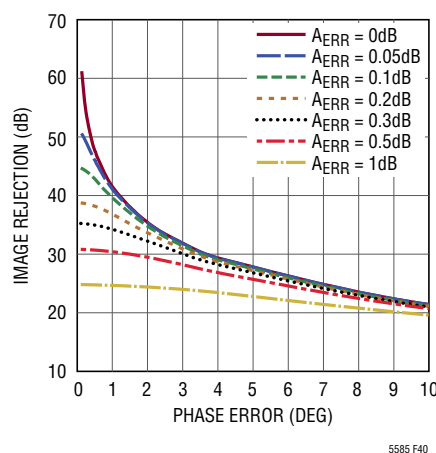
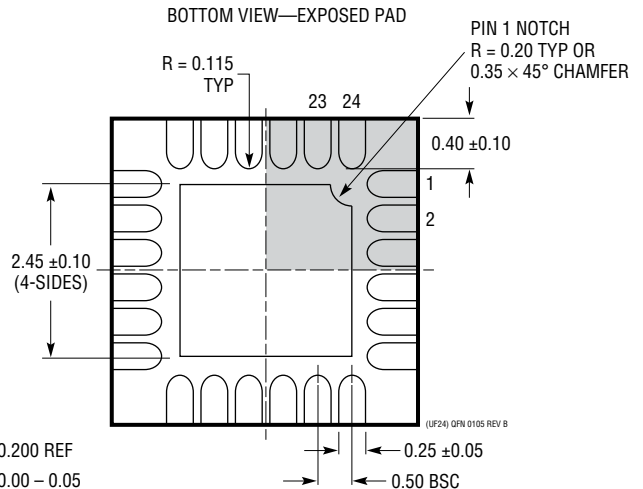
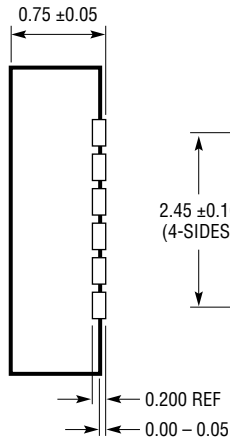
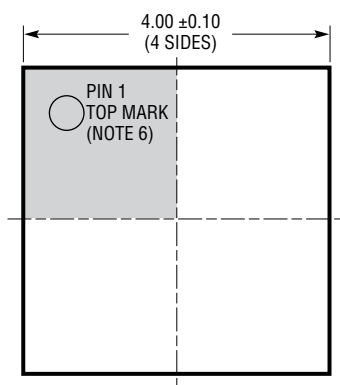
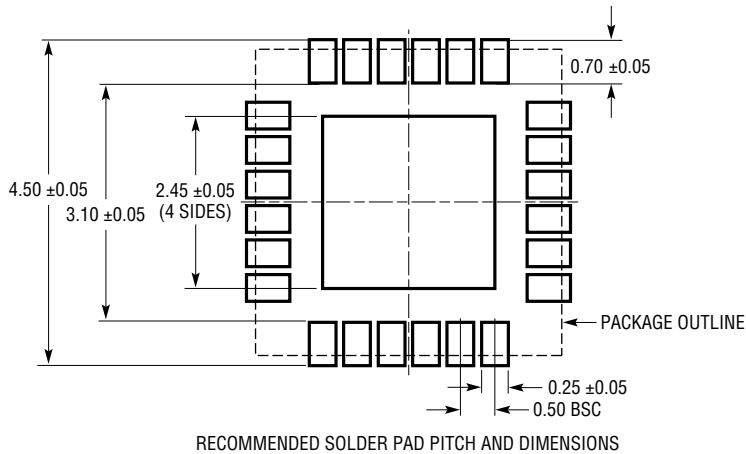

Figure 40. Image Rejection as a Function of Gain and Phase Errors

PACKAGE DESCRIPTION

Please refer to <http://www.linear.com/designtools/packaging/> for the most recent package drawings.

UF Package
24-Lead Plastic QFN (4mm × 4mm)
 (Reference LTC DWG # 05-08-1697 Rev B)



- NOTE:
1. DRAWING PROPOSED TO BE MADE A JEDEC PACKAGE OUTLINE MO-220 VARIATION (WGGD-X)—TO BE APPROVED
 2. DRAWING NOT TO SCALE
 3. ALL DIMENSIONS ARE IN MILLIMETERS
 4. DIMENSIONS OF EXPOSED PAD ON BOTTOM OF PACKAGE DO NOT INCLUDE MOLD FLASH. MOLD FLASH, IF PRESENT, SHALL NOT EXCEED 0.15mm ON ANY SIDE, IF PRESENT
 5. EXPOSED PAD SHALL BE SOLDER PLATED
 6. SHADED AREA IS ONLY A REFERENCE FOR PIN 1 LOCATION ON THE TOP AND BOTTOM OF PACKAGE

REVISION HISTORY

REV	DATE	DESCRIPTION	PAGE NUMBER
A	8/12	Changes to 1950MHz L6, C19 and L5 Matching Component Values	3
		Correction to Plot 5585 G4 Vertical Axis Label	6
		Changes to Plot G20	8
		Changes to Plots G30 and G35	10
		Corrections to Plot G44 Horizontal Axis Label	11
		Changes to Plot G61	13
		Changes to Plot G78	15
		Changes to Figure 1, RF and LO MATCH Table 1950MHz L6, C19 and L5 Component Values	18
		Changes to Figure 5, 1.9GHz L6 and C19 Component Values	20
		Change to Figure 13, 1.9GHz L5 Component Value	22
		Added Reduced Power Consumption Paragraph Title	29
		Correction to Figure 32 Title	29
		Correction to text 1875Hz	31
B	11/14	Changes to Features and Description	1
		Change to 700MHz IRR	3
		Insert 3500MHz Data and Supply Current Condition	4
		Correction to Plot G19 Vertical Axis Label	8
		Correction to Plot G34 Vertical Axis Label	10
		Correction to Plot G45 Horizontal Axis Label	11
		Correction to Plot G60 Vertical Axis Label	13
		Correction to Plot G77 Vertical Axis Label	15
		Change to Figure 1 RF MATCH 2150MHz Table Values	18
		Change to Figure 13 C13 and L5 Component Values	22
		Change to text "lag (or lead)"	23
		Omission of 6mA Current Arrows	24
		Change in Figure 22 C Value	26
		Change in Figure 33 ADC Output D15	30
Change in Typical Application ADC Output D15	38		

TYPICAL APPLICATION

Simplified Schematic of 1950MHz Receiver, (Only I-Channel Is Shown)

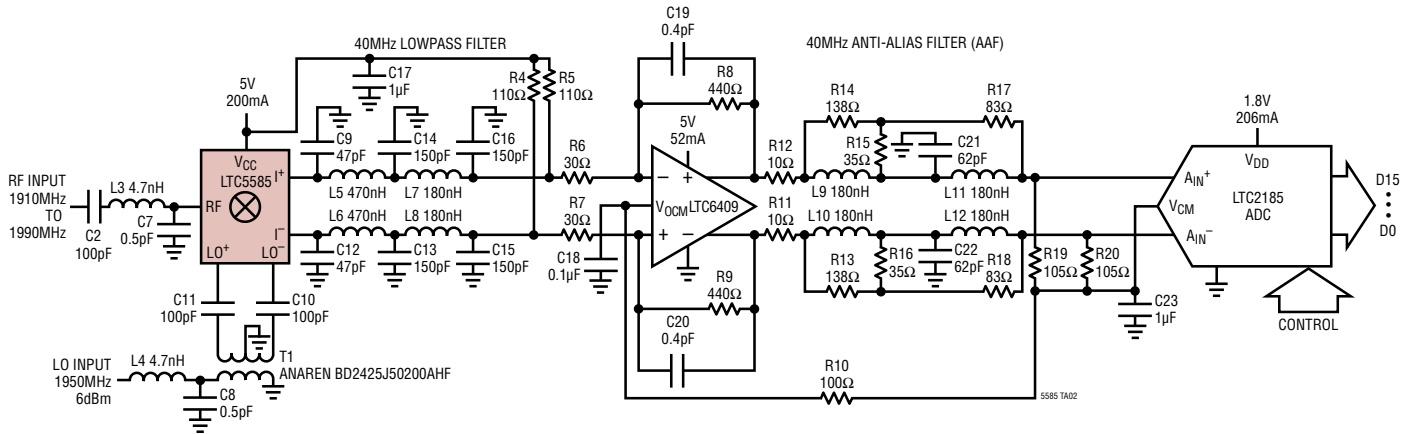

RELATED PARTS

PART NUMBER	DESCRIPTION	COMMENTS
Infrastructure		
LTC5569	300MHz to 4GHz Dual Active Downconverting Mixer	2dB Gain, 26.7dBm IIP3 and 11.7dB NF at 1950MHz, 3.3V/180mA Supply
LT5527	400MHz to 3.7GHz, 5V Downconverting Mixer	2.3dB Gain, 23.5dBm IIP3 and 12.5dB NF at 1900MHz, 5V/78mA Supply
LT5557	400MHz to 3.8GHz, 3.3V Downconverting Mixer	2.9dB Gain, 24.7dBm IIP3 and 11.7dB NF at 1950MHz, 3.3V/82mA Supply
LTC6409	10GHz GBW Differential Amplifier	DC-Coupled, 48dBm OIP3 at 140MHz, 1.1nV/√Hz Input Noise Density
LTC6412	31dB Linear Analog VGA	35dBm OIP3 at 240MHz, Continuous Gain Range -14dB to 17dB
LTC554X	600MHz to 4GHz Downconverting Mixer Family	8dB Gain, >25dBm IIP3, 10dB NF, 3.3V/200mA Supply
LT5554	Ultralow Distortion IF Digital VGA	48dBm OIP3 at 200MHz, 2dB to 18dB Gain Range, 0.125dB Gain Steps
LT5578	400MHz to 2.7GHz Upconverting Mixer	27dBm OIP3 at 900MHz, 24.2dBm at 1.95GHz, Integrated RF Transformer
LT5579	1.5GHz to 3.8GHz Upconverting Mixer	27.3dBm OIP3 at 2.14GHz, NF = 9.9dB, 3.3V Supply, Single-Ended LO and RF Ports
LTC5590	Dual 600MHz to 1.7GHz Downconverting Mixer	8.7dB Gain, 26dBm IIP3, 9.7dB Noise Figure
LTC5591	Dual 1.3GHz to 2.3GHz Downconverting Mixer	8.5dB Gain, 26.2dBm IIP3, 9.9dB Noise Figure
LTC5592	Dual 1.6GHz to 2.7GHz Downconverting Mixer	8.3dB Gain, 27.3dBm IIP3, 9.8dB Noise Figure
RF PLL/Synthesizer with VCO		
LTC6946-1	Low Noise, Low Spurious Integer-N PLL with Integrated VCO	373MHz to 3.74GHz, -157dBc/Hz WB Phase Noise Floor, -100dBc/Hz Closed-Loop Phase Noise
LTC6946-2	Low Noise, Low Spurious Integer-N PLL with Integrated VCO	513MHz to 4.9GHz, -157dBc/Hz WB Phase Noise Floor, -100dBc/Hz Closed-Loop Phase Noise
LTC6946-3	Low Noise, Low Spurious Integer-N PLL with Integrated VCO	640MHz to 5.79GHz, -157dBc/Hz WB Phase Noise Floor, -100dBc/Hz Closed-Loop Phase Noise
ADCs		
LTC2145-14	14-Bit, 125Msps 1.8V Dual ADC	73.1dB SNR, 90dB SFDR, 95mW/Ch Power Consumption
LTC2185	16-Bit, 125Msps 1.8V Dual ADC	76.8dB SNR, 90dB SFDR, 185mW/Channel Power Consumption
LTC2158-14	14-Bit, 310Msps 1.8V Dual ADC, 1.25GHz Full-Power Bandwidth	68.8dB SNR, 88dB SFDR, 362mW/Ch Power Consumption, 1.32V _{p-p} Input Range

X-ON Electronics

Largest Supplier of Electrical and Electronic Components

Click to view similar products for [Modulator/Demodulator](#) category:

Click to view products by [Analog Devices](#) manufacturer:

Other Similar products are found below :

[LC72722PM-TLM-E](#) [HMC495LP3TR](#) [LT5571EUF#PBF](#) [LT5528EUF#PBF](#) [LT5502EGN#PBF](#) [THAT1510S08-U](#) [CMX589AD5](#)
[ADRF6821ACPZ](#) [AD630ADZ](#) [AD630ARZ](#) [AD630JNZ](#) [AD630KNZ](#) [AD8346ARUZ-REEL7](#) [AD8339ACPZ](#) [AD8345ARE](#) [AD8345AREZ](#)
[AD8345AREZ-RL7](#) [AD8347ARUZ](#) [AD8347ARUZ-REEL7](#) [AD8348ARUZ](#) [AD8348ARUZ-REEL7](#) [AD8349AREZ](#) [AD8349AREZ-RL7](#)
[ADL5371ACPZ-R7](#) [ADL5387ACPZ-WP](#) [ADL5387ACPZ-R7](#) [ADL5372ACPZ-R7](#) [ADL5373ACPZ-R7](#) [ADA2200ARUZ-REEL7](#)
[AD8346ARUZ](#) [ADL5380-EVALZ](#) [ADL5382ACPZ-R7](#) [AD630ARZ-RL](#) [ADL5375-15ACPZ-R7](#) [ADL5380ACPZ-R7](#) [ADL5375-05ACPZ-R7](#)
[AD8333ACPZ-WP](#) [AD8341ACPZ-REEL7](#) [ADRF6703ACPZ-R7](#) [ADRF6750ACPZ-R7](#) [ADRF6806ACPZ-R7](#) [HMC1097LP4E](#)
[HMC630LP3ETR](#) [HMC500LP3ETR](#) [HMC495LP3ETR](#) [HMC500LP3E](#) [HMC630LP3E](#) [HMC631LP3E](#) [HMC795LP5E](#) [MC1496DR2G](#)