

FEATURES

- Gain Bandwidth Product: 6.5MHz
- -3dB Bandwidth ($A_V = +1$): 4.5MHz
- Low Quiescent Current: 65µA
- C-Load™ Op Amp Drives all Capacitive Loads
- Offset Voltage: 350µV Maximum
- Rail-to-Rail Input and Output
- Supply Voltage Range: 1.8V to 5.25V
- Input Bias Current: 50nA Maximum
- CMRR/PSRR: 100dB/100dB
- Shutdown Current: 7µA Maximum
- Operating Temperature Range: -40°C to 125°C
- Single in 6-Lead TSOT-23, 2mm × 2mm DFN Packages
- Dual in 8-Lead MS8, MS10, TSOT-23, 2mm × 2mm DFN
- Quad in MS16 Package

APPLICATIONS

- Micropower Active Filters
- Portable Instrumentation
- Battery or Solar Powered Systems
- Automotive Electronics

DESCRIPTION

The [LTC®6255/LTC6256/LTC6257](#) are single/dual/quad operational amplifiers with low noise, low power, low supply voltage, and rail-to-rail inputs and outputs. They are unity gain stable with or without capacitive loads. They feature 6.5MHz gain-bandwidth product, 1.8V/µs slew rate while consuming only 65µA of supply current per amplifier operating on supply voltages ranging from 1.8V to 5.25V. The combination of low supply current, low supply voltage, high gain bandwidth product and low noise makes the LTC6255 family unique among rail-to-rail input/output op amps with similar supply current. These operational amplifiers are ideal for low power and low noise applications.

For applications that require power-down, the LTC6255 and LTC6256 in S6 and MS10 packages offer shutdown which reduces the current consumption to 7µA maximum.

The LTC6255 family can be used as plug-in replacements for many commercially available op amps to reduce power and improve input/output range and performance.

All registered trademarks and trademarks are the property of their respective owners.

TYPICAL APPLICATION

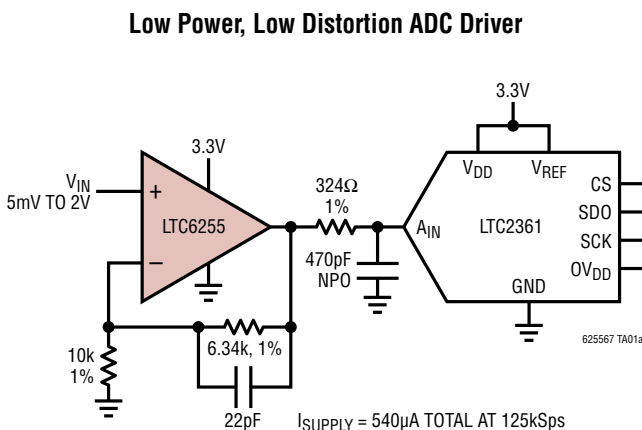

LTC6255 Driving LTC2361 ADC

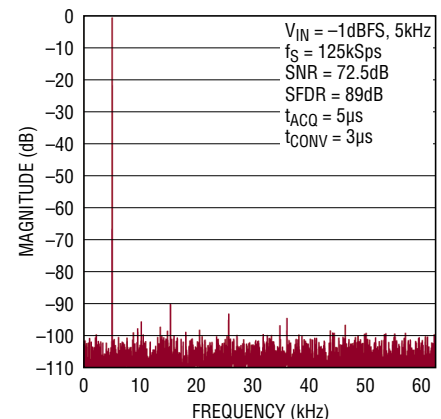

LTC6255/LTC6256/LTC6257

ABSOLUTE MAXIMUM RATINGS

(Note 1)

Supply Voltage: $V^+ - V^-$	5.5V
Input Voltage	$V^- - 0.2$ to $V^+ + 0.2$
Input Current: +IN, -IN, SHDN (Note 2)	± 10 mA
Output Current: OUT	± 20 mA
Output Short-Circuit Duration (Note 3)	Indefinite
Operating Temperature Range (Note 4)	
LTC6255C/LTC6256C/LTC6257C	-40°C to 85°C
LTC6255I/LTC6256I/LTC6257I	-40°C to 85°C
LTC6255H/LTC6256H/LTC6257H	-40°C to 125°C

Specified Temperature Range (Note 5)

LTC6255C/LTC6256C/LTC6257C	0°C to 70°C
LTC6255I/LTC6256I/LTC6257I	-40°C to 85°C
LTC6255H/LTC6256H/LTC6257H	-40°C to 125°C
Maximum Junction Temperature	150°C
Storage Temperature Range	-65°C to 150°C
Lead Temperature (Soldering, 10 sec)	
S6, TS8, MS8, MS only	300°C

PIN CONFIGURATION

<p style="text-align: center;">TOP VIEW</p> <p style="text-align: center;">KC PACKAGE 8-LEAD (2mm × 2mm × 0.6mm) PLASTIC UDFN</p> <p style="text-align: center;">$T_{JMAX} = 125^\circ\text{C}$, $\theta_{JA} = 89^\circ\text{C/W}$ (NOTE 6) EXPOSED PAD (PIN 9) IS V^-, MUST BE SOLDERED TO PCB</p> <p style="text-align: center;">OBsolete PACKAGE</p>	<p style="text-align: center;">TOP VIEW</p> <p style="text-align: center;">S6 PACKAGE 6-LEAD PLASTIC TSOT-23</p> <p style="text-align: center;">$T_{JMAX} = 150^\circ\text{C}$, $\theta_{JA} = 192^\circ\text{C/W}$ (NOTE 6)</p>
<p style="text-align: center;">TOP VIEW</p> <p style="text-align: center;">TS8 PACKAGE 8-LEAD PLASTIC TSOT-23</p> <p style="text-align: center;">$T_{JMAX} = 150^\circ\text{C}$, $\theta_{JA} = 195^\circ\text{C/W}$ (NOTE 6)</p>	<p style="text-align: center;">TOP VIEW</p> <p style="text-align: center;">MS8 PACKAGE 8-LEAD PLASTIC MSOP</p> <p style="text-align: center;">$T_{JMAX} = 150^\circ\text{C}$, $\theta_{JA} = 163^\circ\text{C/W}$ (NOTE 6)</p>
<p style="text-align: center;">TOP VIEW</p> <p style="text-align: center;">MS PACKAGE 10-LEAD PLASTIC MSOP</p> <p style="text-align: center;">$T_{JMAX} = 150^\circ\text{C}$, $\theta_{JA} = 160^\circ\text{C/W}$ (NOTE 6)</p>	<p style="text-align: center;">TOP VIEW</p> <p style="text-align: center;">MS PACKAGE 16-LEAD PLASTIC MSOP</p> <p style="text-align: center;">$T_{JMAX} = 150^\circ\text{C}$, $\theta_{JA} = 125^\circ\text{C/W}$ (NOTE 6)</p>
<p style="text-align: center;">TOP VIEW</p> <p style="text-align: center;">DC PACKAGE 8-LEAD (2mm × 2mm × 0.8mm) PLASTIC DFN</p> <p style="text-align: center;">$T_{JMAX} = 125^\circ\text{C}$, $\theta_{JA} = 102^\circ\text{C/W}$ (NOTE 6) EXPOSED PAD (PIN 9) IS V^-, MUST BE SOLDERED TO PCB</p>	<p style="text-align: center;">TOP VIEW</p> <p style="text-align: center;">DC PACKAGE 6-LEAD (2mm × 2mm) PLASTIC DFN</p> <p style="text-align: center;">$T_{JMAX} = 125^\circ\text{C}$, $\theta_{JA} = 102^\circ\text{C/W}$ (NOTE 6) EXPOSED PAD (PIN 7) IS V^-, MUST BE SOLDERED TO PCB</p>

Rev E

ORDER INFORMATION

Lead Free Finish

TAPE AND REEL (MINI)	TAPE AND REEL	PART MARKING*	PACKAGE DESCRIPTION	TEMPERATURE RANGE
LTC6255CS6#TRMPBF	LTC6255CS6#TRPBF	LTFFT	6-Lead Plastic TSOT-23	0°C to 70°C
LTC6255IS6#TRMPBF	LTC6255IS6#TRPBF	LTFFT	6-Lead Plastic TSOT-23	-40°C to 85°C
LTC6255HS6#TRMPBF	LTC6255HS6#TRPBF	LTFFT	6-Lead Plastic TSOT-23	-40°C to 125°C
LTC6255CDC#TRMPBF	LTC6255CDC#TRPBF	LFFV	6-Lead (2mm × 2mm × 0.8mm) Plastic DFN	0°C to 70°C
LTC6255IDC#TRMPBF	LTC6255IDC#TRPBF	LFFV	6-Lead (2mm × 2mm × 0.8mm) Plastic DFN	-40°C to 85°C
LTC6256CTS8#TRMPBF	LTC6256CTS8#TRPBF	LTFFW	8-Lead Plastic TSOT-23	0°C to 70°C
LTC6256ITS8#TRMPBF	LTC6256ITS8#TRPBF	LTFFW	8-Lead Plastic TSOT-23	-40°C to 85°C
LTC6256HTS8#TRMPBF	LTC6256HTS8#TRPBF	LTFFW	8-Lead Plastic TSOT-23	-40°C to 125°C
OBSOLETE				
LTC6256CKC#TRMPBF	LTC6256CKC#TRPBF	DXYT	8-Lead (2mm × 2mm × 0.6mm) Plastic UTDFN	0°C to 70°C
LTC6256IKC#TRMPBF	LTC6256IKC#TRPBF	DXYT	8-Lead (2mm × 2mm × 0.6mm) Plastic UTDFN	-40°C to 85°C
LTC6256CDC#TRMPBF	LTC6256CDC#TRPBF	LGVP	8-Lead (2mm × 2mm × 0.8mm) Plastic DFN	0°C to 70°C
LTC6256IDC#TRMPBF	LTC6256IDC#TRPBF	LGVP	8-Lead (2mm × 2mm × 0.8mm) Plastic DFN	-40°C to 85°C
LTC6256CMS8#PBF	LTC6256CMS8#TRPBF	LTDXW	8-Lead Plastic MSOP	0°C to 70°C
LTC6256IMS8#PBF	LTC6256IMS8#TRPBF	LTDXW	8-Lead Plastic MSOP	-40°C to 85°C
LTC6256CMS#PBF	LTC6256CMS#TRPBF	LTDXX	10-Lead Plastic MSOP	0°C to 70°C
LTC6256IMS#PBF	LTC6256IMS#TRPBF	LTDXX	10-Lead Plastic MSOP	-40°C to 85°C
LTC6257CMS#PBF	LTC6257CMS#TRPBF	6257	16-Lead Plastic MSOP	0°C to 70°C
LTC6257IMS#PBF	LTC6257IMS#TRPBF	6257	16-Lead Plastic MSOP	-40°C to 85°C
LTC6257HMS#PBF	LTC6257HMS#TRPBF	6257	16-Lead Plastic MSOP	-40°C to 125°C

Consult ADI Marketing for parts specified with wider operating temperature ranges.

[Tape and reel specifications](#). Some packages are available in 500 unit reels through designated sales channels with #TRMPBF suffix.

5V ELECTRICAL CHARACTERISTICS

The ● denotes the specifications which apply over the full operating temperature range, otherwise specifications are at $T_A = 25^\circ\text{C}$. $V_{\text{SUPPLY}} = 5\text{V}$, $V_{\text{CM}} = V_{\text{OUT}} = V_{\text{SUPPLY}}/2$, $C_L = 10\text{pF}$, V_{SHDN} is unconnected.

SYMBOL	PARAMETER	CONDITIONS	MIN	TYP	MAX	UNITS
V_{OS}	Input Offset Voltage	$V_{\text{CM}} = V^- + 0.3\text{V}$ (PNP Region)	● -350	100	350	μV
			-700		700	μV
		$V_{\text{CM}} = V^+ - 0.3\text{V}$ (NPN Region)	● -350	100	350	μV
			-700		700	μV
$V_{\text{OS TC}}$	Input Offset Voltage Drift	$V_{\text{CM}} = V^- + 0.3\text{V}, V^+ - 0.3\text{V}$	●	1.5		$\mu\text{V}/^\circ\text{C}$
I_{B}	Input Bias Current (Note 7)	$V_{\text{CM}} = V^- + 0.3\text{V}$	● -50	-5	50	nA
			-75		75	nA
		$V_{\text{CM}} = V^+ - 0.3\text{V}$	● -50	5	50	nA
			-75		75	nA
I_{OS}	Input Offset Current	$V_{\text{CM}} = V^- + 0.3\text{V}$	● -20	2	20	nA
			-35		35	nA
		$V_{\text{CM}} = V^+ - 0.3\text{V}$	● -20	2	20	nA
			-35		35	nA
e_n	Input Voltage Noise Density	$f = 1\text{kHz}$		20		$\text{nV}/\sqrt{\text{Hz}}$
	Input Noise Voltage	$f = 0.1\text{Hz to }10\text{Hz}$		2.5		$\mu\text{V}_{\text{P-P}}$

Rev E

LTC6255/LTC6256/LTC6257

5V ELECTRICAL CHARACTERISTICS The ● denotes the specifications which apply over the full operating temperature range, otherwise specifications are at $T_A = 25^\circ\text{C}$. $V_{\text{SUPPLY}} = 5\text{V}$, $V_{\text{CM}} = V_{\text{OUT}} = V_{\text{SUPPLY}}/2$, $C_L = 10\text{pF}$, V_{SHDN} is unconnected.

SYMBOL	PARAMETER	CONDITIONS	MIN	TYP	MAX	UNITS
i_n	Input Current Noise Density	$f = 1\text{kHz}$, $V_{\text{CM}} = 0\text{V}$ to 4V (PNP Input)		380		$f_A/\sqrt{\text{Hz}}$
		$f = 1\text{kHz}$, $V_{\text{CM}} = 4\text{V}$ to 5V (NPN Input)		850		$f_A/\sqrt{\text{Hz}}$
R_{IN}	Input Resistance	Differential		1		$\text{M}\Omega$
		Common Mode		10		$\text{M}\Omega$
C_{IN}	Input Capacitance	Differential		0.4		pF
		Common Mode		0.3		pF
CMRR	Common Mode Rejection Ratio	$V_{\text{CM}} = 0.3\text{V}$ to 3.5V	● 75 71	100		dB dB
IVR	Input Voltage Range		● -0.1		5.1	V
PSRR	Power Supply Rejection Ratio	$V_{\text{CM}} = 0.4\text{V}$, V_S Ranges from 1.8V to 5V	● 82 78	100		dB dB
A_V	Large Signal Gain	$V_{\text{OUT}} = 0.5\text{V}$ to 4.5V , $R_{\text{LOAD}} = 100\text{k}$	● 50 28	200		V/mV V/mV
		$V_{\text{OUT}} = 0.5\text{V}$ to 4.5V , $R_{\text{LOAD}} = 10\text{k}$	● 25 8	50		V/mV V/mV
V_{OL}	Output Swing Low (Input Overdrive 30mV). Measured from V^-	No Load	●	6	25	mV mV
		$I_{\text{SINK}} = 100\mu\text{A}$	●	10	30	mV mV
		$I_{\text{SINK}} = 1\text{mA}$	●	30	75	mV mV
V_{OH}	Output Swing High (Input Overdrive 30mV). Measured from V^+	No Load	●	24	55	mV mV
		$I_{\text{SOURCE}} = 100\mu\text{A}$	●	30	80	mV mV
		$I_{\text{SOURCE}} = 1\text{mA}$	●	75	150	mV mV
I_{SC}	Output Short-Circuit Current		● 17 8	35		mA mA
I_S	Supply Current per Amplifier		● 57 42	65	85	μA μA
	Supply Current in Shutdown		●	6	7	μA μA
I_{SHDN}	Shutdown Pin Current	$V_{\text{SHDN}} = 0.6\text{V}$	● -1400	-1000		nA
		$V_{\text{SHDN}} = 1.5\text{V}$	● -900	-500		nA
V_{IL}	SHDN Input Low Voltage	Disable	●		0.6	V
V_{IH}	SHDN Input High Voltage	Enable	● 1.5			V
t_{ON}	Turn-On Time	SHDN Toggle from 0V to 5V		50		μs
t_{OFF}	Turn-Off Time	SHDN Toggle from 5V to 0V		20		μs
BW	-3dB Closed Loop Bandwidth	$A_V = 1$		4.5		MHz
GBW	Gain-Bandwidth Product	$f = 200\text{kHz}$	● 2.5	6.5		MHz
			2			MHz
t_S	Settling Time, 0.5V to 4.5V , Unity Gain	0.1%		4		μs
		0.01%		6		μs
SR	Slew Rate	$A_V = -1$, $V_{\text{OUT}} = 0.5\text{V}$ to 4.5V , $C_{\text{LOAD}} = 10\text{pF}$, $R_F = R_G = 10\text{k}\Omega$	● 1.0 0.75	1.8		V/ μs V/ μs
FPBW	Full Power Bandwidth (Note 8)	$4V_{\text{P-P}}$		140		kHz
THD+N	Total Harmonic Distortion and Noise	$f = 500\text{Hz}$, $A_V = 2$, $R_L = 4\text{k}\Omega$, $V_{\text{OUTP-P}} = 1\text{V}$, $V_{\text{IN}} = 2.25\text{V}$ to 2.75V		0.0022		% dB
I_{LEAK}	Output Leakage Current in Shutdown	$V_{\text{SHDN}} = 0\text{V}$, $V_{\text{OUT}} = 0\text{V}$	● -400		400	nA
		$V_{\text{SHDN}} = 0\text{V}$, $V_{\text{OUT}} = 5\text{V}$	● -400		400	nA

Rev E

1.8V ELECTRICAL CHARACTERISTICS

The ● denotes the specifications which apply over the full operating temperature range, otherwise specifications are at $T_A = 25^\circ\text{C}$. $V_{\text{SUPPLY}} = 1.8\text{V}$, $V_{\text{CM}} = V_{\text{OUT}} = 0.4\text{V}$, $C_L = 10\text{pF}$, V_{SHDN} is unconnected.

SYMBOL	PARAMETER	CONDITIONS	MIN	TYP	MAX	UNITS
V_{OS}	Input Offset Voltage	$V_{\text{CM}} = V^- + 0.3\text{V}$	● -350 -700	100	350 700	μV μV
		$V_{\text{CM}} = V^+ - 0.3\text{V}$	● -350 -700	100	350 700	μV μV
$V_{\text{OS TC}}$	Input Offset Voltage Drift	$V_{\text{CM}} = V^- + 0.3\text{V}, V^+ - 0.3\text{V}$	●	1.5		$\mu\text{V}/^\circ\text{C}$
I_{B}	Input Bias Current (Note 7)	$V_{\text{CM}} = V^- + 0.3\text{V}$	● -50 -75	-8	50 75	nA nA
		$V_{\text{CM}} = V^+ - 0.3\text{V}$	● -50 -75	5	50 75	nA nA
I_{OS}	Input Offset Current	$V_{\text{CM}} = V^- + 0.3\text{V}$	● -20 -35	2	20 35	nA nA
		$V_{\text{CM}} = V^+ - 0.3\text{V}$	● -20 -35	2	20 35	nA nA
e_{n}	Input Voltage Noise Density	$f = 1\text{kHz}, V_{\text{CM}} = 0.4\text{V}$		21		$\text{nV}/\sqrt{\text{Hz}}$
	Input Noise Voltage	$f = 0.1\text{Hz to } 10\text{Hz}$		2.5		$\mu\text{V}_{\text{P-P}}$
i_{n}	Input Current Noise Density	$f = 1\text{kHz}, V_{\text{CM}} = 0\text{V to } 0.8\text{V}$ (PNP Input) $f = 1\text{kHz}, V_{\text{CM}} = 1\text{V to } 1.8\text{V}$ (NPN Input)		580 870		$f_{\text{A}}/\sqrt{\text{Hz}}$ $f_{\text{A}}/\sqrt{\text{Hz}}$
R_{IN}	Input Resistance	Differential		1		$\text{M}\Omega$
		Common Mode		10		$\text{M}\Omega$
C_{IN}	Input Capacitance	Differential		0.4		pF
		Common Mode		0.3		pF
CMRR	Common Mode Rejection Ratio	$V_{\text{CM}} = 0.2\text{V to } 1.6\text{V}$	● 74 67	90		dB dB
IVR	Input Voltage Range		● -0.1		1.9	V
PSRR	Power Supply Rejection Ratio	$V_{\text{CM}} = 0.4\text{V}, V_{\text{S}}$ Ranges from 1.8V to 5V	● 82 78	100		dB dB
A_{V}	Large Signal Gain	$V_{\text{OUT}} = 0.5\text{V to } 1.3\text{V}, R_{\text{LOAD}} = 100\text{k}$	● 30 17	110		V/mV V/mV
		$V_{\text{OUT}} = 0.5\text{V to } 1.3\text{V}, R_{\text{LOAD}} = 10\text{k}$	● 15 5	50		V/mV V/mV
V_{OL}	Output Swing Low (Input Overdrive 30mV), Measured from V^-	No Load	● 6	35		mV mV
		$I_{\text{SINK}} = 100\mu\text{A}$	● 10	40		mV mV
		$I_{\text{SINK}} = 1\text{mA}$	● 30	75		mV mV

LTC6255/LTC6256/LTC6257

1.8V ELECTRICAL CHARACTERISTICS

The ● denotes the specifications which apply over the full operating temperature range, otherwise specifications are at $T_A = 25^\circ\text{C}$. $V_{\text{SUPPLY}} = 1.8\text{V}$, $V_{\text{CM}} = V_{\text{OUT}} = 0.4\text{V}$, $C_L = 10\text{pF}$, V_{SHDN} is unconnected.

SYMBOL	PARAMETER	CONDITIONS	MIN	TYP	MAX	UNITS
V_{OH}	Output Swing High (Input Overdrive 30mV), Measured from V^+	No Load	●	24	55 60	mV mV
		$I_{\text{SOURCE}} = 100\mu\text{A}$	●	30	65 75	mV mV
		$I_{\text{SOURCE}} = 1\text{mA}$	●	75	135 150	mV mV
I_{SC}	Output Short-Circuit Current		●	12 3	17	mA mA
I_{S}	Supply Current per Amplifier		●	53 35	60 83	μA μA
	Supply Current in Shutdown		●	1.4	2.0 3.0	μA μA
I_{SHDN}	Shutdown Pin Current	$V_{\text{SHDN}} = 0.5\text{V}$	●	-480	-350	nA
		$V_{\text{SHDN}} = 1.3\text{V}$	●	-160	-40	nA
V_{IL}	SHDN Input Low Voltage	Disable	●		0.5	V
V_{IH}	SHDN Input High Voltage	Enable	●	1.3		V
t_{ON}	Turn-On Time	SHDN Toggle From 0V to 1.8V		150		μs
t_{OFF}	Turn-Off Time	SHDN Toggle From 1.8V to 0V		50		μs
BW	-3dB Closed Loop Bandwidth	$A_V = 1$		4		MHz
GBW	Gain-Bandwidth Product	$f = 200\text{kHz}$	●	2.4 1.8	6	MHz MHz
T_{S}	Settling Time, 0.3V to 1.5V, Unity Gain	0.1%		4		μs
		0.01%		6		μs
SR	Slew Rate	$A_V = -1$, $V_{\text{OUT}} = 0.3\text{V}$ to 1.5V , $C_{\text{LOAD}} = 10\text{pF}$	●	0.9 0.75	1.5	V/ μs V/ μs
FPBW	Full Power Bandwidth (Note 8)	$1.2V_{\text{P-P}}$		400		kHz
THD+N	Total Harmonic Distortion and Noise	$f = 500\text{Hz}$, $A_V = 2$, $R_L = 4\text{k}\Omega$, $V_{\text{OUTP-P}} = 1\text{V}$		0.006		%
		$V_{\text{IN}} = 0.25\text{V}$ to 0.75V		84		dB

Note 1: Stresses beyond those listed under Absolute Maximum Ratings may cause permanent damage to the device. Exposure to any Absolute Maximum Rating condition for extended periods may affect device reliability and lifetime.

Note 2: The inputs are protected by back-to-back diodes as well as ESD protection diodes to each power supply. If the differential input voltage exceeds 3.6V or the input extends more than 500mV beyond the power supply, the input current should be limited to less than 10mA.

Note 3: A heat sink may be required to keep the junction temperature below the absolute maximum rating when the output is shorted indefinitely.

Note 4: The LTC6255C/LTC6256C/LTC6257C and LTC6255I/LTC6256I/LTC6257I are guaranteed functional over the temperature range of -40°C to 85°C . The LTC6255H/LTC6256H/LTC6257H are guaranteed functional over the temperature range of -40°C to 125°C .

Note 5: The LTC6255C/LTC6256C/LTC6257C are guaranteed to meet the specified performance from 0°C to 70°C . The LTC6255C/LTC6256C/LTC6257C are designed, characterized and expected to meet specified performance from -40°C to 85°C but are not tested or QA sampled at these temperatures. The LTC6255I/LTC6256I/LTC6257I are guaranteed to meet specified performance from -40°C to 85°C . The LTC6255H/LTC6256H/LTC6257H are guaranteed to meet specified performance from -40°C to 125°C .

Note 6: Thermal resistance varies with the amount of PC board metal connected to the package. The specified values are for short traces connected to the leads.

Note 7: The input bias current is the average of the currents through the positive and negative input pins.

Note 8: Full power bandwidth is calculated from the slew rate $\text{FPBW} = \text{SR}/\pi \cdot V_{\text{P-P}}$.

TYPICAL PERFORMANCE CHARACTERISTICS

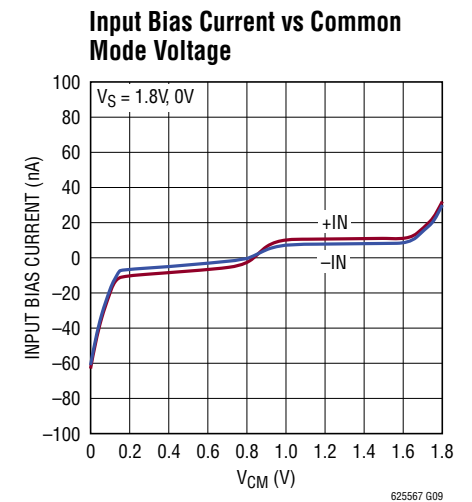
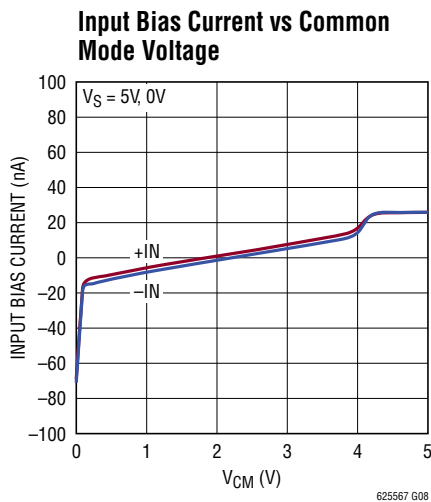
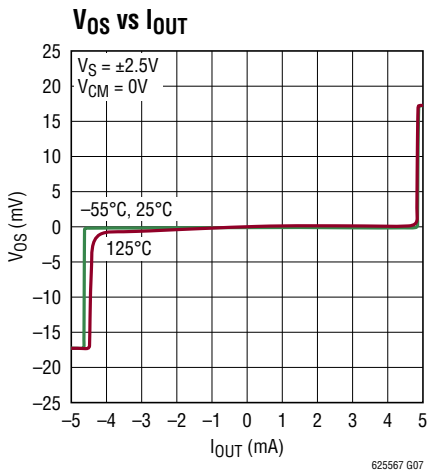
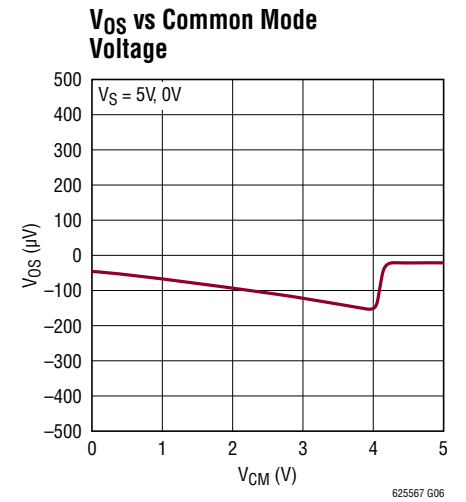
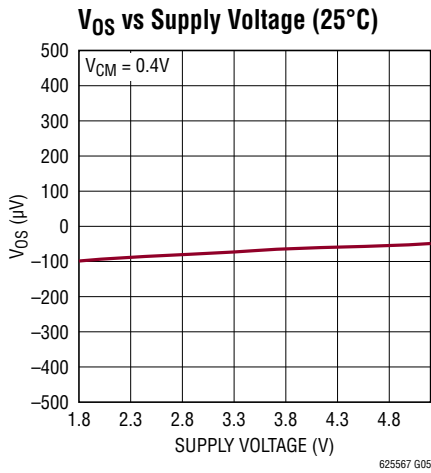
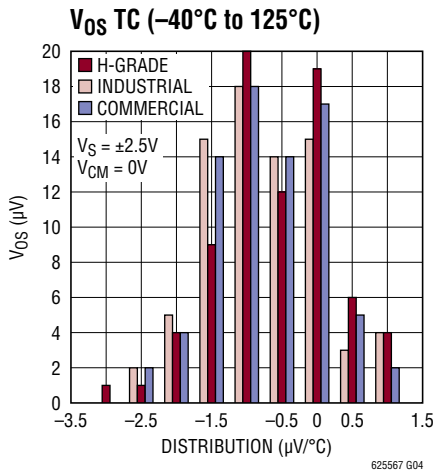
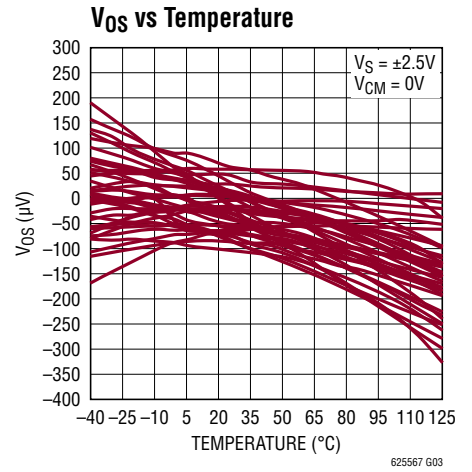
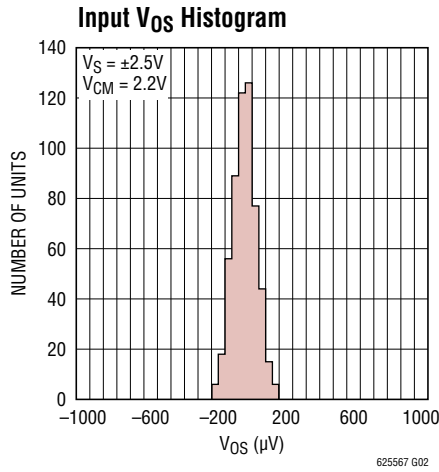
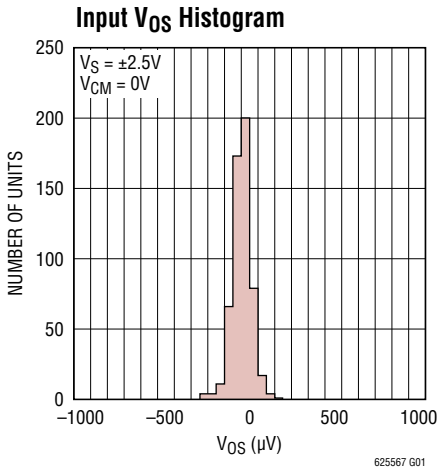

TYPICAL PERFORMANCE CHARACTERISTICS

Input Bias Current vs Supply Voltage

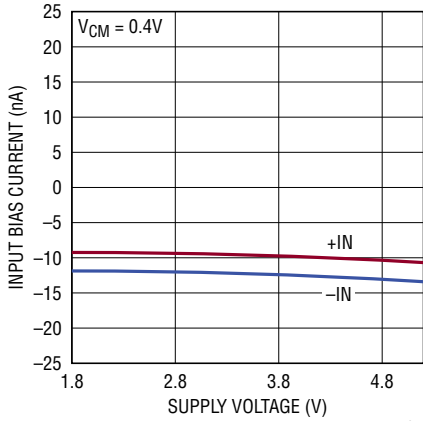

Input Bias Current vs Temperature

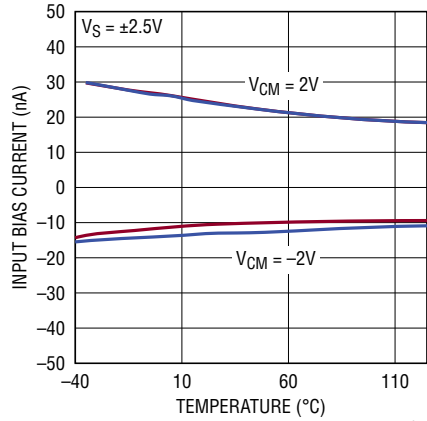

Supply Current vs Supply Voltage per Channel

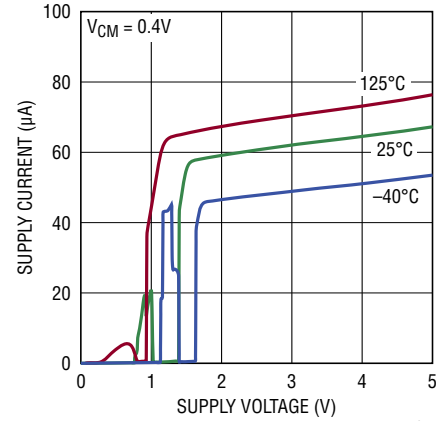

Supply Current vs Temperature

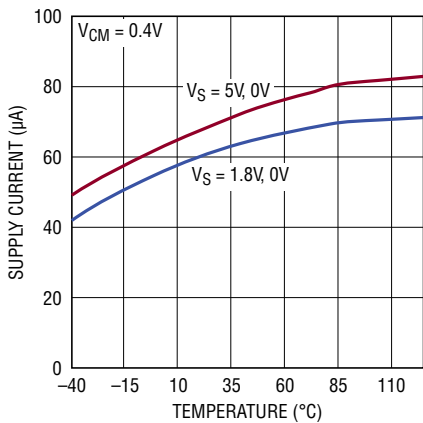

Output Saturation Voltage vs Load Current (Output High)

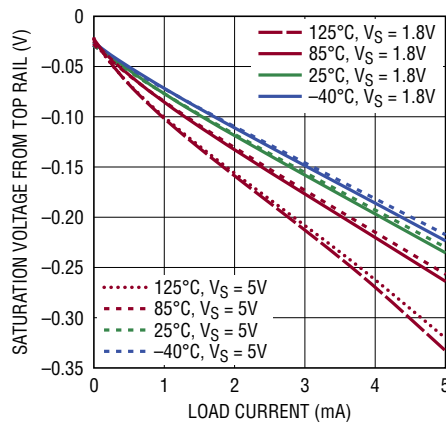

Output Saturation Voltage vs Load Current (Output Low)

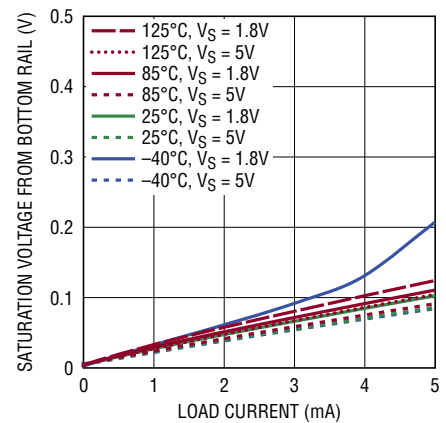

Output Short-Circuit Current vs Supply Voltage (Sourcing)

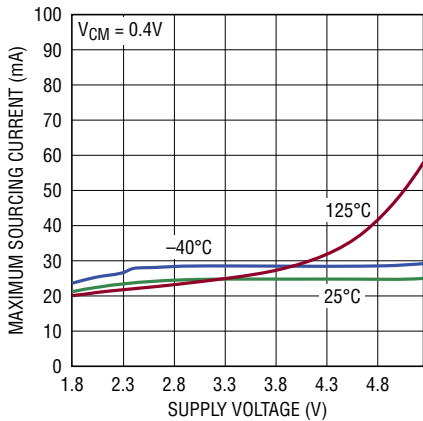

Output Short-Circuit Current vs Supply Voltage (Sinking)

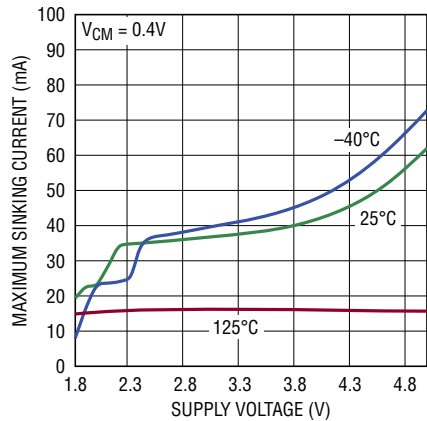

0.1Hz to 10Hz Output Voltage Noise

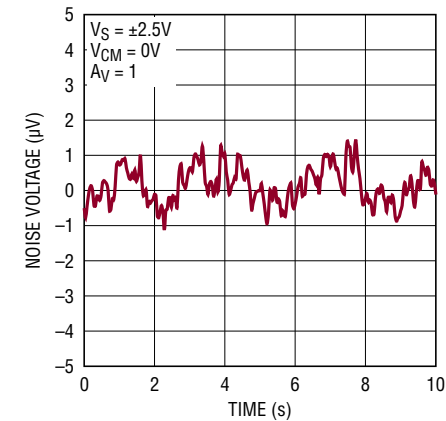

TYPICAL PERFORMANCE CHARACTERISTICS

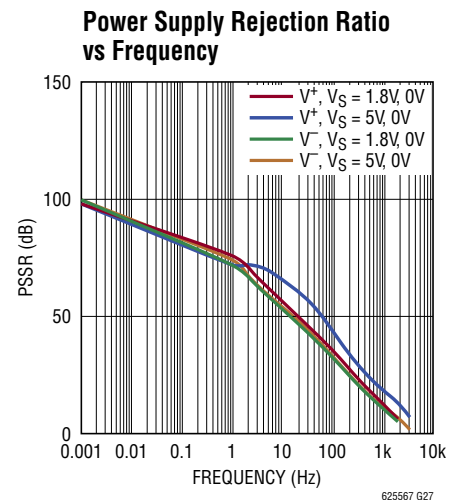
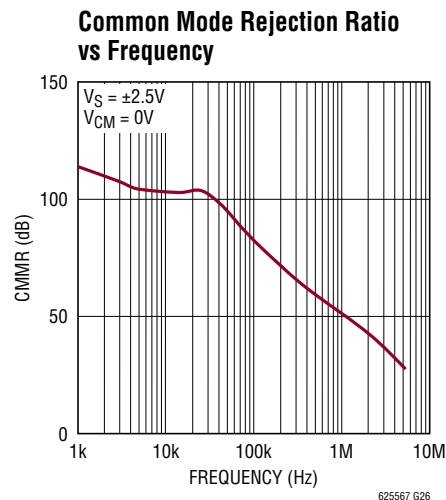
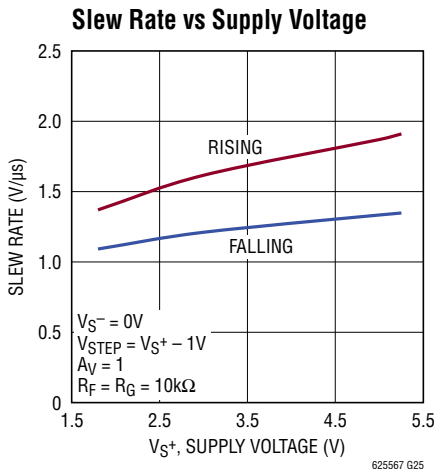
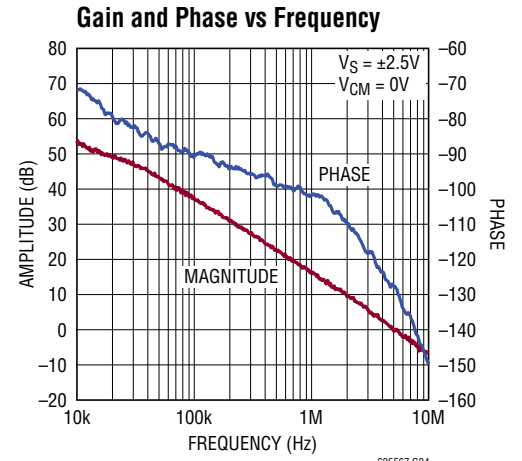
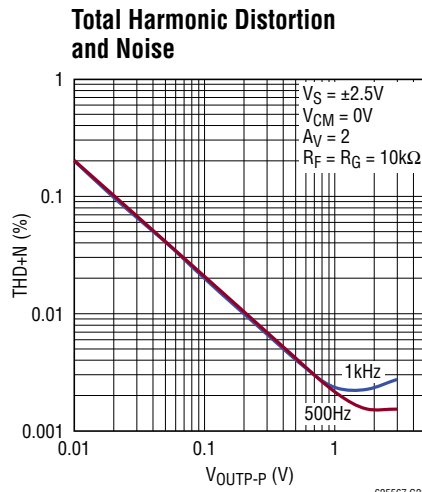
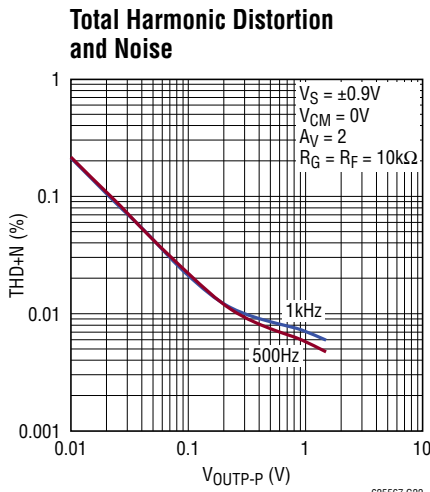
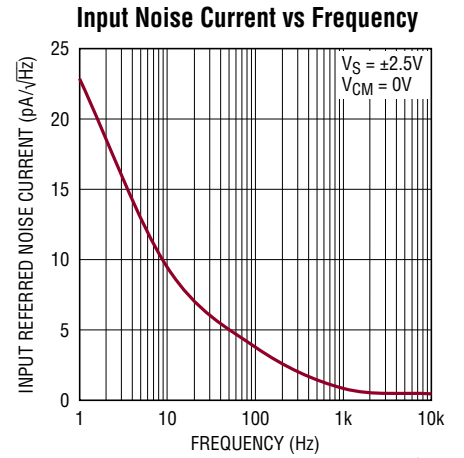
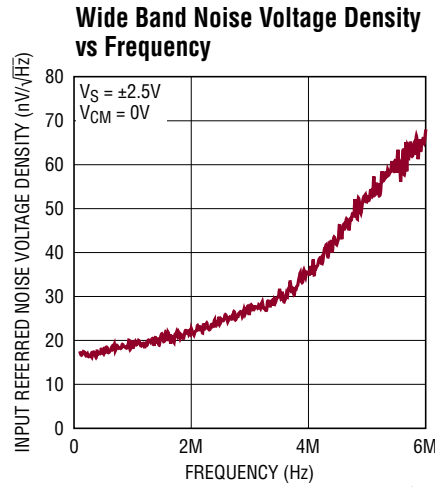
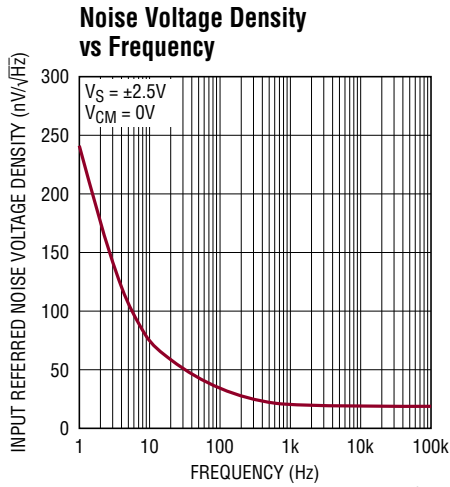

TYPICAL PERFORMANCE CHARACTERISTICS

Capacitive Load Handling Overshoot vs Capacitive Load

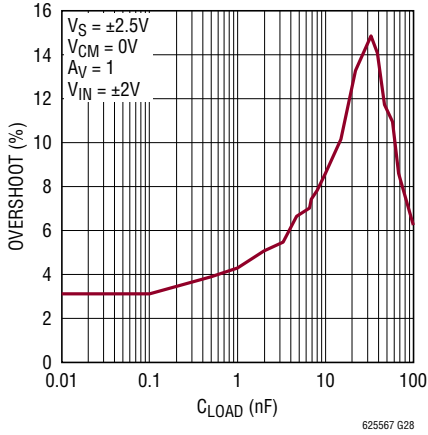

Large-Signal Response

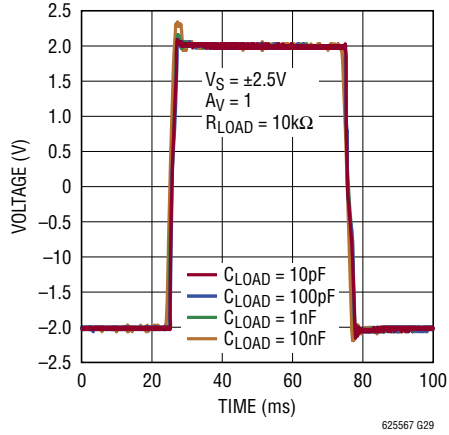

Large-Signal Response

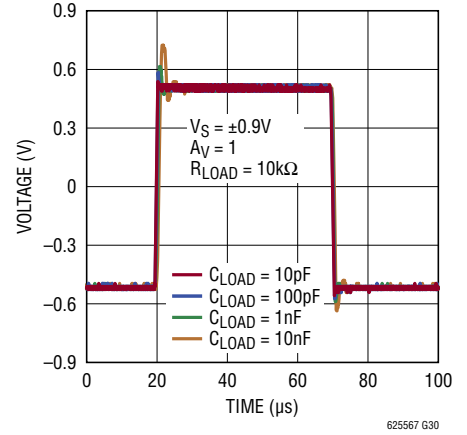

Small-Signal Response

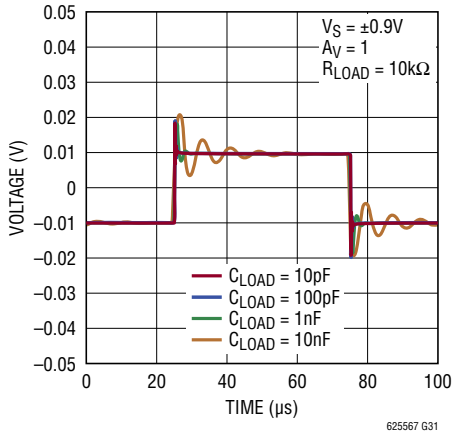

Large-Signal Response

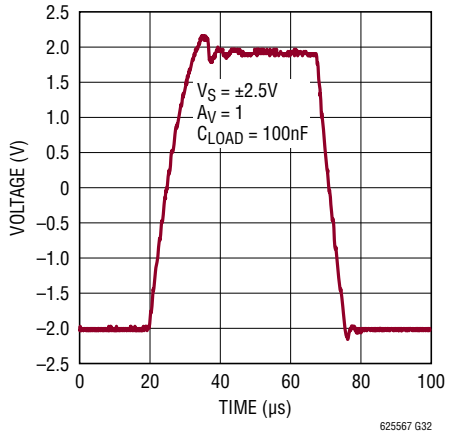

Small-Signal Response

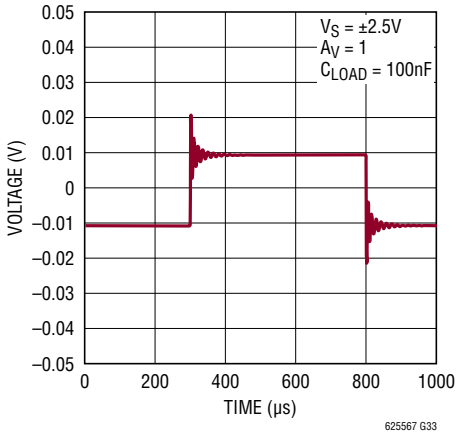

Output Impedance vs Frequency

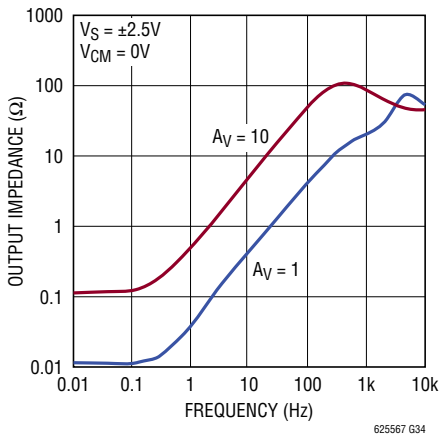

Supply Current vs \overline{SHDN} Pin Voltage

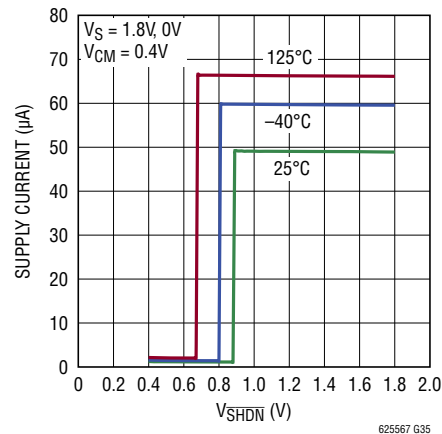

Supply Current vs \overline{SHDN} Pin Voltage

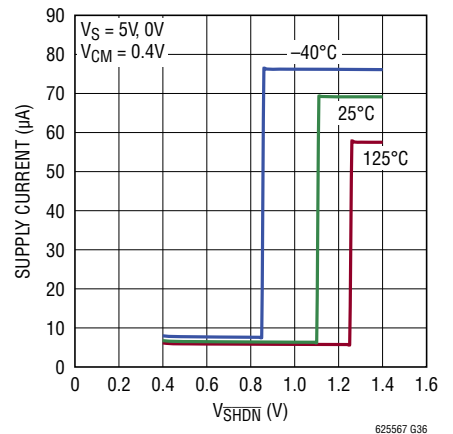

PIN FUNCTIONS

-IN: Inverting Input of the Amplifier. Voltage range of this pin can go from $V^- - 0.1V$ to $V^+ + 0.1V$.

+IN: Non-Inverting Input of Amplifier. This pin has the same voltage range as -IN.

V⁺: Positive Power Supply. Typically the voltage is from 1.8V to 5.25V. Split supplies are possible as long as the voltage between V^+ and V^- is between 1.8V and 5.25V. A bypass capacitor of 0.1 μ F as close to the part as possible should be used between power supply pins or between supply pins and ground.

V⁻: Negative Power Supply. It is normally tied to ground. It can also be tied to a voltage other than ground as long as the voltage between V^+ and V^- is from 1.8V to 5.25V. If it is not connected to ground, bypass it with a capacitor of 0.1 μ F as close to the part as possible.

SHDN: Active Low Shutdown. Shutdown threshold is 0.6V above negative rail. If left unconnected, the amplifier will be on.

OUT: Amplifier Output. The voltage range extends to within millivolts of each supply rail.

SIMPLIFIED SCHEMATIC

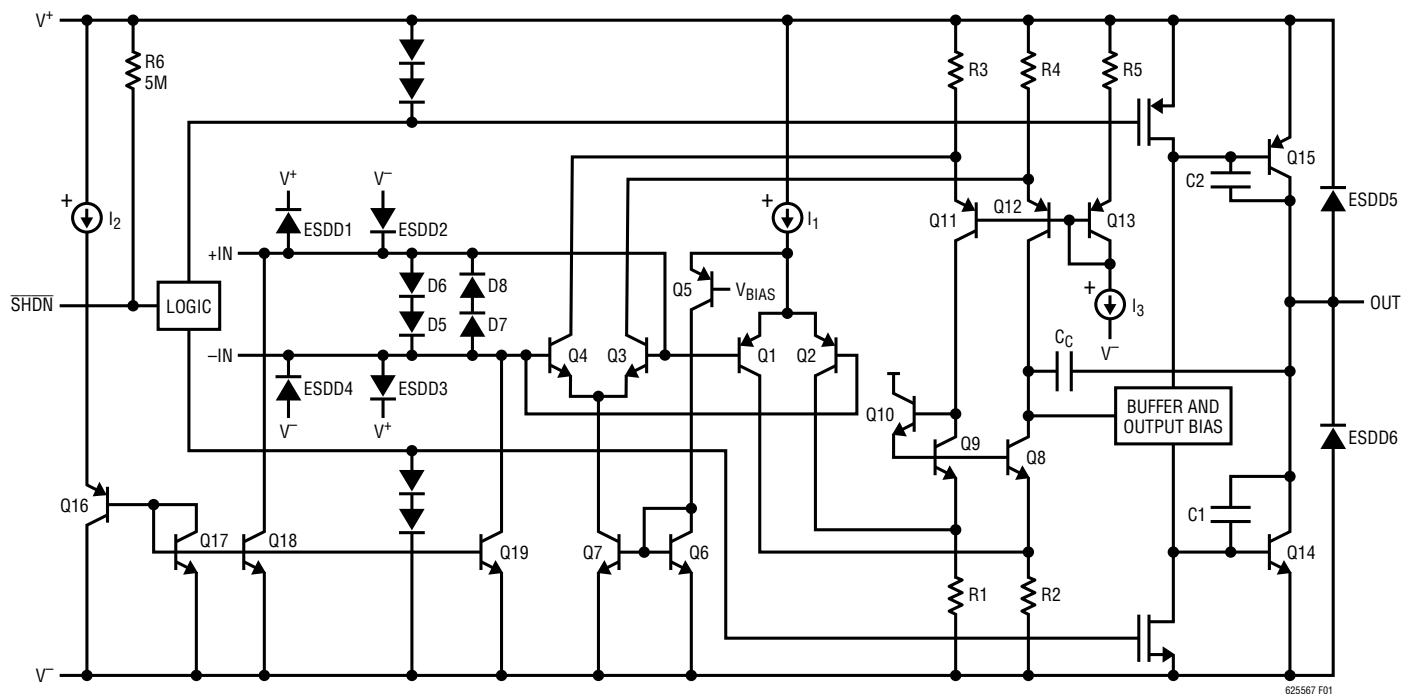

Figure 1. LTC6255/LTC6256/LTC6257 Simplified Schematic

OPERATION

The LTC6255 family input signal range extends beyond the negative and positive power supplies. The output can even extend all the way to the negative supply with the proper external pull-down current source. Figure 1 depicts a Simplified Schematic of the amplifier. The input stage is comprised of two differential amplifiers, a PNP stage Q1/Q2 and NPN stage Q3/Q4 that are active over different ranges of common mode input voltage. The PNP stage is active between the negative power supply to approximately 1V below the positive supply. As the input voltage approaches the positive supply, transistor Q5 will steer the tail current I_1 to the current mirror Q6/Q7, activating the NPN differential pair and the PNP pair becomes inactive

for the remaining input common mode range. Also for the input stage, devices Q17, Q18 and Q19 act to cancel the bias current of the PNP input pair. When Q1/Q2 is active, the current in Q16 is controlled to be the same as the current Q1/Q2. Thus, the base current of Q16 is normally equal to the base current of the input devices of Q1/Q2. Similar circuitry (not shown) is used to cancel the base current of Q3/Q4. The buffer and output bias stage uses a special compensation technique to take full advantage of the process technology to drive high capacitive loads. The common emitter topology of Q14/Q15 enables the output to swing from rail to rail.

APPLICATIONS INFORMATION

Low Supply Voltage and Low Power Consumption

The LTC6255 family of operational amplifiers can operate with power supply voltages from 1.8V to 5.25V. Each amplifier draws only 65 μ A. The low supply voltage capability and low supply current are ideal for portable applications.

High Capacitive Load Driving Capability and Wide Bandwidth

The LTC6255 family is optimized for wide bandwidth low power applications. They have an extremely high gain-bandwidth to power ratio and are unity gain stable. When the load capacitance increases, the increased capacitance at the output pushed the non-dominant pole to lower frequency in the open loop frequency response, worsening the phase and gain margin. They are designed to directly drive up to 100nF capacitive load in unity gain configuration (see Typical Performance Characteristics, Capacitive Load Handling). Higher gain configurations tend to have better capacitive drive capability than lower gain configurations due to lower closed loop bandwidth and hence higher phase margin.

Low Input Referred Noise

The LTC6255 family provides a low input referred noise of 20nV/ $\sqrt{\text{Hz}}$ at 1kHz. The noise density will grow slowly with the frequency in wideband range. The average noise voltage density over 3MHz range is less than 24nV/ $\sqrt{\text{Hz}}$. The LTC6255 family is ideal for low noise and low power signal processing applications.

Low Input Offset Voltage

The LTC6255 family has a low offset voltage of 350 μ V maximum which is essential for precision applications. The offset voltage is trimmed with a proprietary trim algorithm to ensure low offset voltage over the entire common mode voltage range.

Low Input Bias Current

The LTC6255 family uses a bias current cancellation circuit to compensate for the base current of the input transistors. When the input common mode voltage is within 200mV of either rail, the bias cancellation circuit are no longer active. For common mode voltages ranging from 0.2V above

APPLICATIONS INFORMATION

the negative supply to 0.2V below the positive supply, the low input bias current allows the amplifiers to be used in applications with high resistance sources.

Ground Sensing and Rail to Rail Output

The LTC6255 family has excellent output drive capability, delivering over 10mA of output drive current. The output stage is a rail-to-rail topology that is capable of swinging to within 30mV of either rail. If output swing to the negative rail is required, an external pull down resistor to a negative supply can be added. For 5V/0V op amp supplies, a pull down resistor of 2.1k to $-2V$ will allow a ‘true zero’ output swing. In this case, the output can swing all the way to the bottom rail while maintaining 80dB of open loop gain. Since the inputs can go 100mV beyond either rail, the op amp can easily perform ‘true ground’ sensing.

The maximum output current is a function of total supply voltage. As the supply voltage to the amplifier increases, the output current capability also increases. Attention must be paid to keep the junction temperature of the IC below 150°C when the output is in continuous short-circuit. The output of the amplifier has reverse-biased diodes connected to each supply. The output should not be forced more than 0.5V beyond either supply, otherwise current will flow through these diodes.

Input Protection and Output Overdrive

To prevent breakdown of the input transistors, the input stages are protected against a large differential input voltage by two pairs of back-to-back diodes, D5 to D8. If the differential input voltage exceeds 1.4V, the current in these diodes must be limited to less than 10mA. These amplifiers are not intended for open loop applications such as comparators. When the output stage is overdriven, internal limiting circuitry is activated to improve overdrive recovery. In some applications, this circuitry may draw as much as 1mA supply current.

ESD

The LTC6255 family has reverse-biased ESD protection diodes on all inputs and output as shown in Figure 1.

Supply Voltage Ramping

Fast ramping of the supply voltage can cause a current glitch in the internal ESD protection circuits. Depending on the supply inductance, this could result in a supply voltage transient that exceeds the maximum rating. A supply voltage ramp time of greater than 1ms is recommended.

Feedback Components

Care must be taken to ensure that the pole formed by the feedback resistors and the parasitic capacitance at the inverting input does not degrade stability. For example, in a gain of +2 configuration with gain and feedback resistors of 10k, a poorly designed circuit board layout with parasitic capacitance of 5pF (part +PC board) at the amplifier’s inverting input will cause the amplifier to oscillate due to a pole formed at 3.2MHz. An additional capacitor of 5pF across the feedback resistor as shown in Figure 2 will eliminate any ringing or oscillation.

Shutdown

The single and dual versions have $\overline{\text{SHDN}}$ pins that can shut down the amplifier to less than $7\mu\text{A}$ supply current. The $\overline{\text{SHDN}}$ pin voltage needs to be within 0.6V of V^- for the amplifier to shut down. During shutdown, the output will be in high output resistance state, which is suitable for multiplexer applications. When left floating, the $\overline{\text{SHDN}}$ pin is internally pulled up to the positive supply and the amplifier remains enabled.

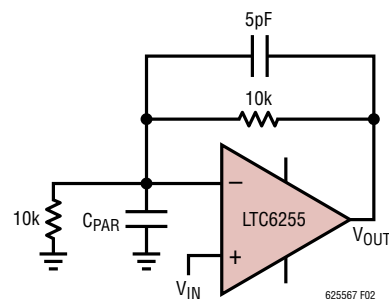

Figure 2.

TYPICAL APPLICATIONS

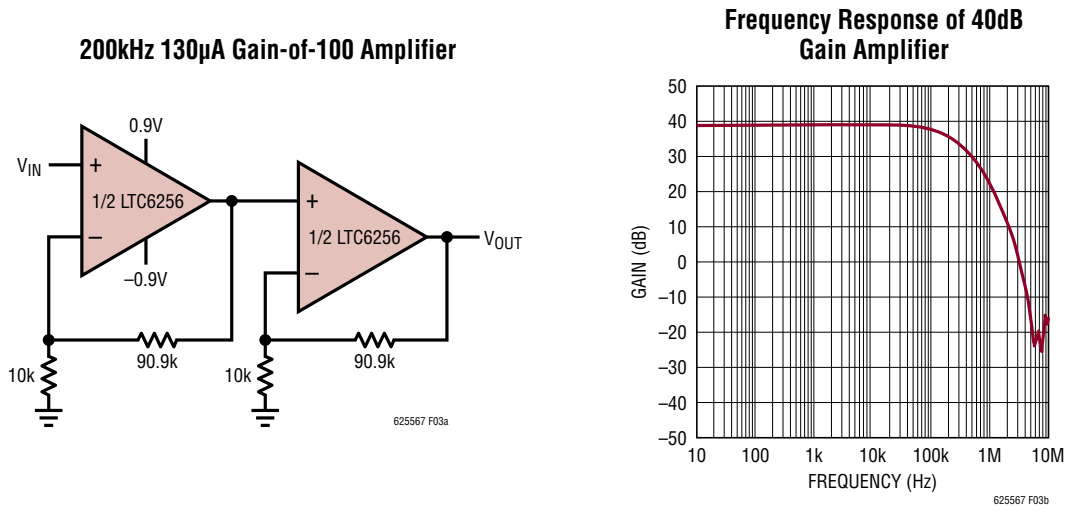

Figure 3. Gain of 100 Amplifier (3dB Bandwidth of 200kHz on 130µA Supply Current)

LTC6255 Very Low Power 2nd Order Lowpass Filter

The LTC6256 circuit shown in Figure 4 is a 2nd order, 100kHz, Butterworth lowpass filter. The filter's differential output maximizes the dynamic range in very low voltage operation. A general 2nd order lowpass circuit is shown in

Figure 5 with the equations to calculate the RC components for cutoff frequencies up to 100kHz for a Butterworth or a Bessel approximation (a Bessel lowpass filter has very low transient response overshoot). In addition the equations for a 4th order lowpass filter are provided to calculate the RC components for two cascaded 2nd order sections.

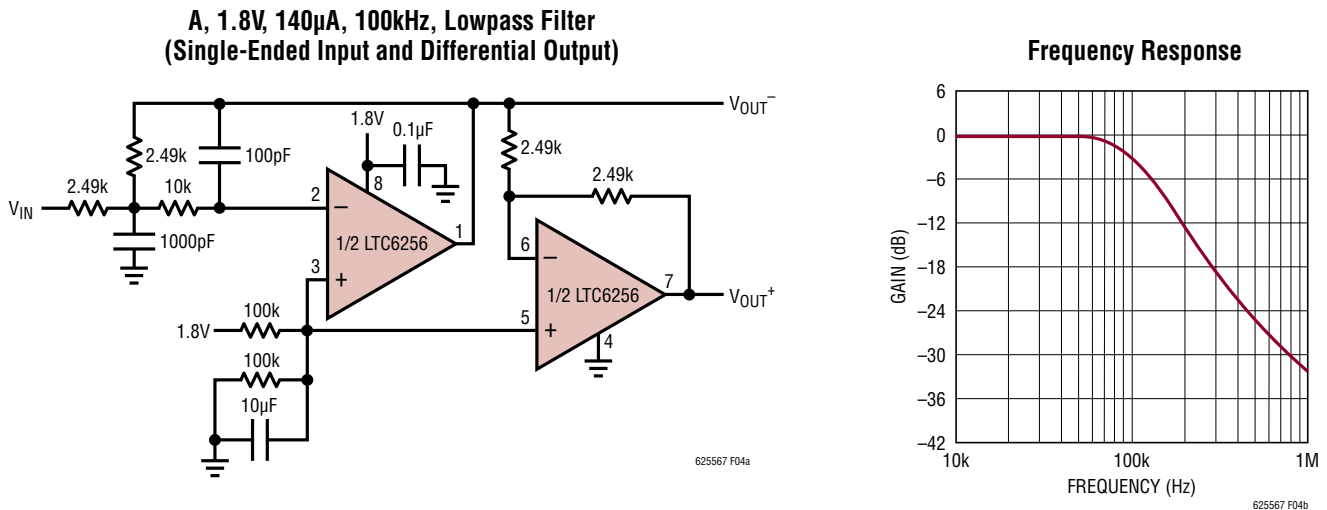

Figure 4

TYPICAL APPLICATIONS

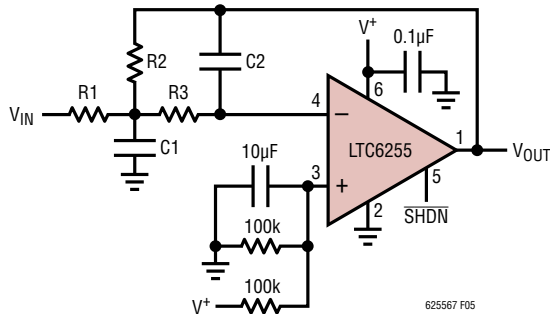

Figure 5

RC Component Equations

$$R2 = \frac{1 - \sqrt{\left(1 - 4Q^2[\text{Gain} + 1]\frac{C2}{C1}\right)}}{4\pi Q f_0 C2}$$

$$R3 = \frac{1}{4\pi^2 R2 C1 C2 f_0^2}$$

$$\text{Gain} = \frac{R2}{R1}$$

$$R1 = \frac{R2}{\text{Gain}}$$

$$C1 > 4Q^2(\text{Gain} + 1)C2$$

Maximum $f_{-3dB} = 100\text{kHz}$ and

$$\text{Maximum Gain} = \frac{100\text{kHz}}{f_{-3dB}}$$

Table 1.

f_0 AND Q VALUES		
2nd Order Lowpass		
Butterworth	$f_0 = f_{-3dB}$	$Q = 0.707$
Bessel	$f_0 = 1.274 \cdot f_{-3dB}$	$Q = 0.577$
4th Order Lowpass		
Butterworth	$f_0 = f_{-3dB}$ $f_0 = f_{-3dB}$	$Q = 0.541$ $Q = 1.307$
Bessel	$f_0 = 1.419 \cdot f_{-3dB}$ $f_0 = 1.591 \cdot f_{-3dB}$	$Q = 0.522$ $Q = 0.806$

2µs Rise Time Analog 1A Pulsed LED Current Driver

Figure 6 shows the LTC6255 applied as a fast, efficient analog LED current driver. High power LEDs are used in applications ranging from brake lights to video projectors. Most LED applications pulse the LEDs for the best efficiency, and many applications take advantage of control of both pulse width and analog current amplitude.

In order to extend the circuit's input range to accommodate 5V output DACs, the input voltage is initially divided by 50 through the R1:R2 divider. The reduced step is applied to the LTC6255 non inverting input, and LTC6255 output rises until MOSFETs Q1 through Q3 begin to turn on, increasing the current in their drains and therefore the LED. The amount of current is sensed on R3, and fed back to the LTC6255 inverting input through R5. The loop is compensated by R5 and C1, with R4 distancing the gate capacitance from the op amp output for the best time domain response. 10% to 90% rise time was measured at 2µs on a 10mA to 1A pulse. Starting at 0 current there is an additional delay of 2.7µs.

It may seem strange to use a micropower op amp in a high current LED application, but it can be justified by the low duty cycles encountered in LED drive applications. A one amp LED is quite bright even when driven at 1% or even 0.1% duty cycles and these constitute 10mA and 1mA average current levels respectively, in which case the supply current of the op amp becomes noticeable. The LTC6255 combines 6.5MHz of gain-bandwidth product and 1.8V/µs slew rate on a supply current budget of only 65µA.

TYPICAL APPLICATIONS

When V_{IN} is at 0V, the op amp supply current is nominally 65 μ A, but the 450 μ V maximum input offset may appear across R3 inducing a 4.5mA current in the LED. Some applications want a guaranteed zero LED current at $V_{IN} = 0$, and this is the purpose of R_{UP} . R_{UP} forces 5 μ A reverse current through R5 creating a negative 1.2mV output offset at R3. This guarantees a zero LED current, but note that the op

amp supply current rises from 65 μ A to a still respectable 650 μ A in this case due to internal protection circuitry for the output stage. For reduced current, the LTC6255 can be shut down, but the output becomes high impedance and may leak high which will turn on the MOSFETs and LED hard. Adding pull-down resistor R_{SD} ensures that the LTC6255 output goes low when shutting down.

2 μ s Rise Time Analog 1A Pulsed LED Current Driver

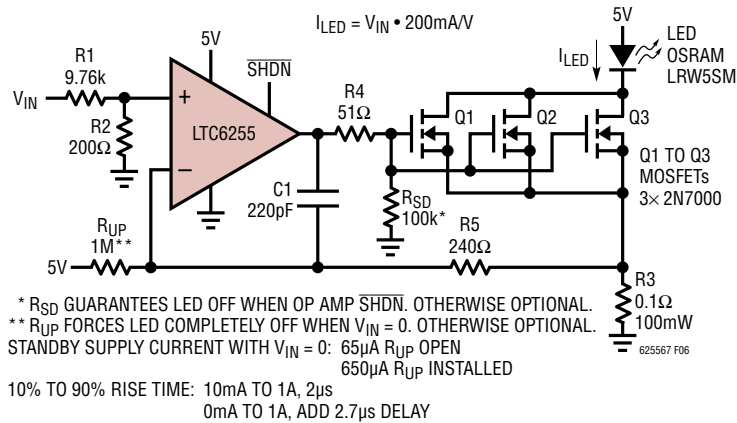

Figure 6. LTC6255 Applied as a LED Current Driver with 2 μ s Rise Time

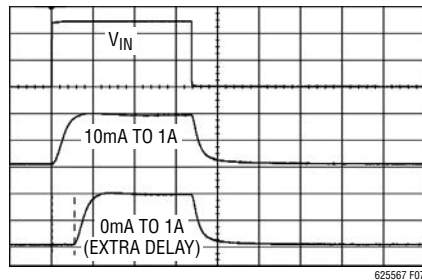
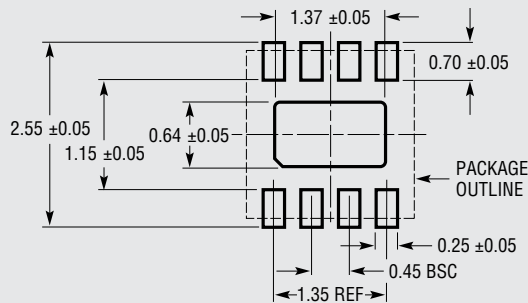

Figure 7. Time Domain Response Showing 2 μ s Rise Time. Top Waveform Is V_{IN} . Middle Waveform Is the 10mA to 1A Step Measured at R3, then the 0mA to 1A Step Showing Extra 2.7 μ s Delay When Recovering From 0mA

PACKAGE DESCRIPTION

KC Package
8-Lead Plastic UTDFN (2mm × 2mm)
 (Reference LTC DWG # 05-08-1749 Rev 0)



RECOMMENDED SOLDER PAD PITCH AND DIMENSIONS
 APPLY SOLDER MASK TO AREAS THAT ARE NOT SOLDERED

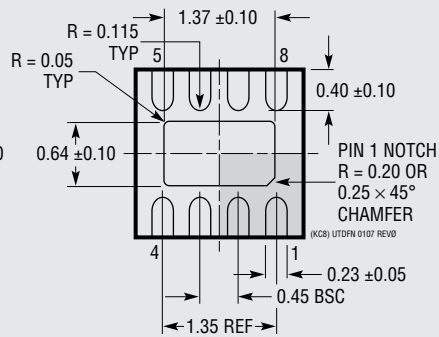
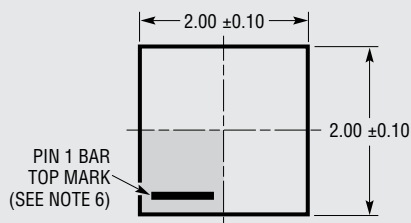

BOTTOM VIEW—EXPOSED PAD

NOTE:

1. DRAWING IS NOT A JEDEC PACKAGE OUTLINE
2. DRAWING NOT TO SCALE
3. ALL DIMENSIONS ARE IN MILLIMETERS
4. DIMENSIONS OF EXPOSED PAD ON BOTTOM OF PACKAGE DO NOT INCLUDE MOLD FLASH. MOLD FLASH, IF PRESENT, SHALL NOT EXCEED 0.15mm ON ANY SIDE
5. EXPOSED PAD SHALL BE SOLDER PLATED
6. SHADED AREA IS ONLY A REFERENCE FOR PIN 1 LOCATION ON THE TOP AND BOTTOM OF PACKAGE

OBSELETE PACKAGE

PACKAGE DESCRIPTION

S6 Package
6-Lead Plastic TSOT-23
 (Reference LTC DWG # 05-08-1636)

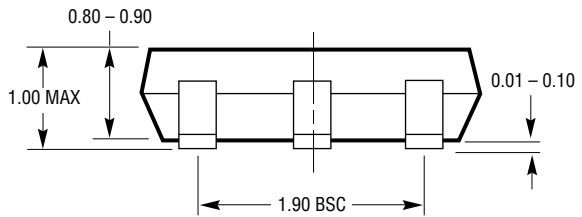
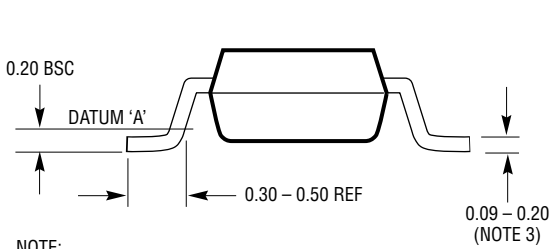
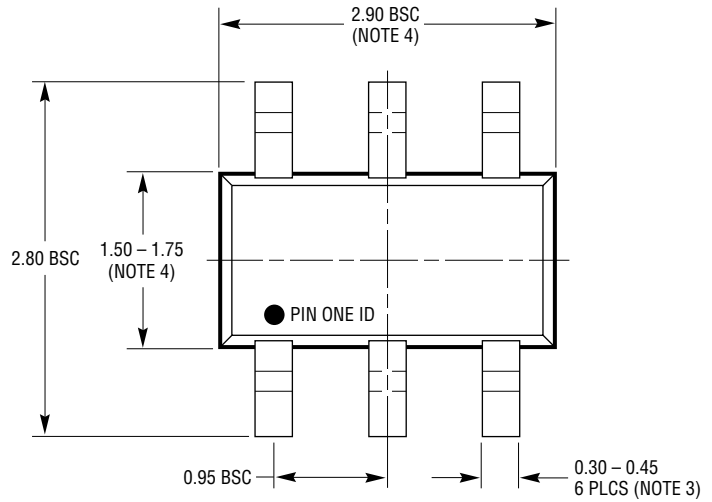
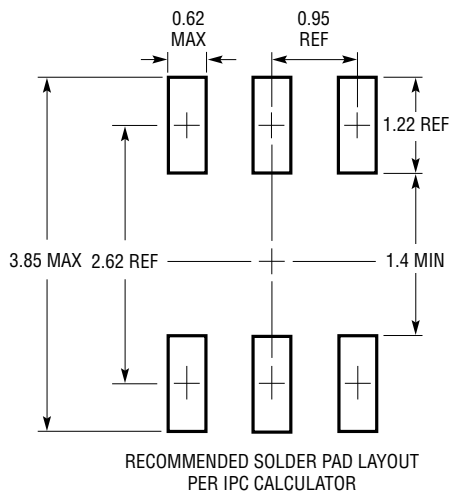

S6 TSOT-23 0302 REV B

- NOTE:
1. DIMENSIONS ARE IN MILLIMETERS
 2. DRAWING NOT TO SCALE
 3. DIMENSIONS ARE INCLUSIVE OF PLATING
 4. DIMENSIONS ARE EXCLUSIVE OF MOLD FLASH AND METAL BURR
 5. MOLD FLASH SHALL NOT EXCEED 0.254mm
 6. JEDEC PACKAGE REFERENCE IS MO-193

PACKAGE DESCRIPTION

TS8 Package
8-Lead Plastic TSOT-23
 (Reference LTC DWG # 05-08-1637 Rev A)

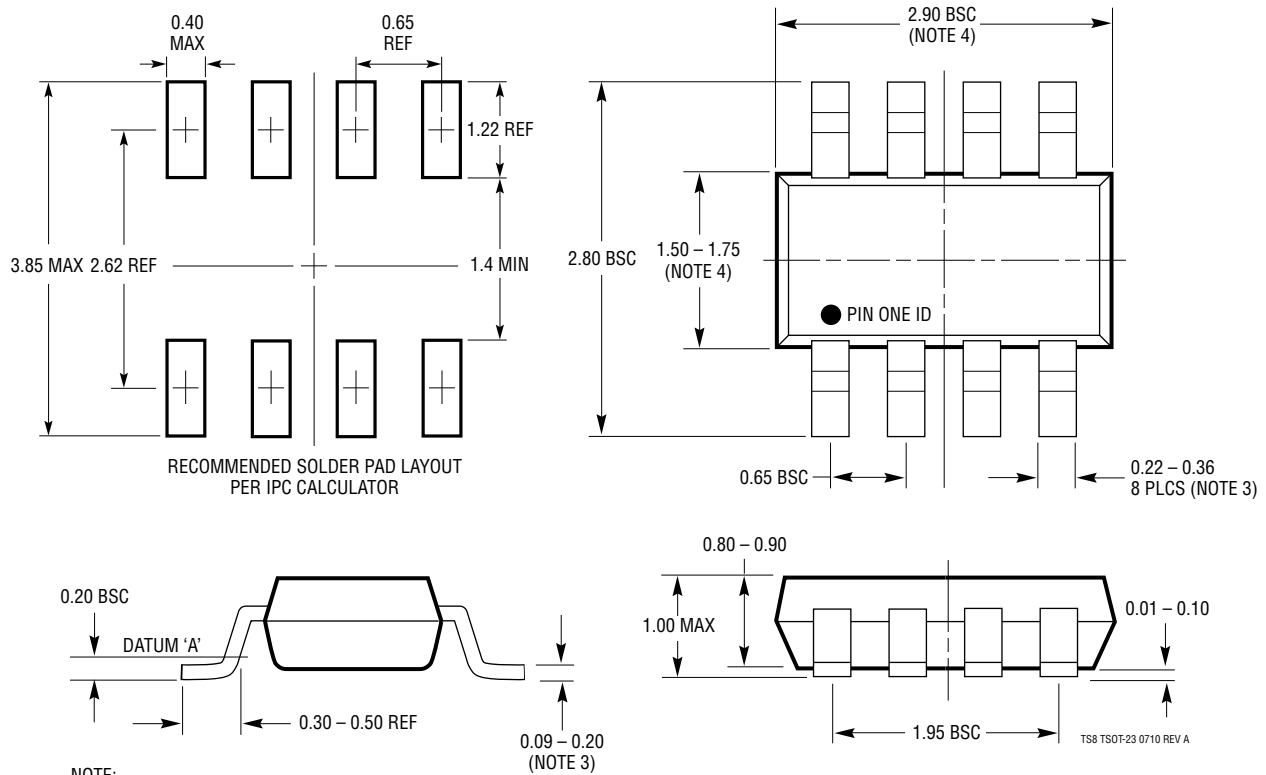

- NOTE:
1. DIMENSIONS ARE IN MILLIMETERS
 2. DRAWING NOT TO SCALE
 3. DIMENSIONS ARE INCLUSIVE OF PLATING
 4. DIMENSIONS ARE EXCLUSIVE OF MOLD FLASH AND METAL BURR
 5. MOLD FLASH SHALL NOT EXCEED 0.254mm
 6. JEDEC PACKAGE REFERENCE IS MO-193

PACKAGE DESCRIPTION

MS8 Package 8-Lead Plastic MSOP

(Reference LTC DWG # 05-08-1660 Rev G)

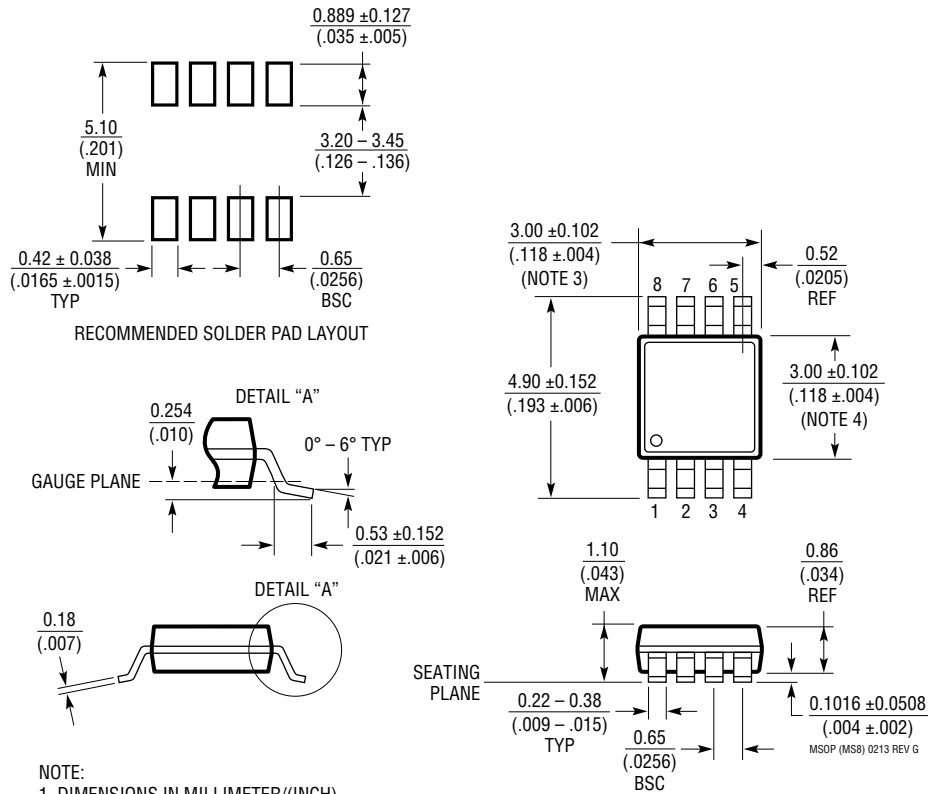

NOTE:

1. DIMENSIONS IN MILLIMETER/(INCH)
2. DRAWING NOT TO SCALE
3. DIMENSION DOES NOT INCLUDE MOLD FLASH, PROTRUSIONS OR GATE BURRS.
MOLD FLASH, PROTRUSIONS OR GATE BURRS SHALL NOT EXCEED 0.152mm (.006") PER SIDE
4. DIMENSION DOES NOT INCLUDE INTERLEAD FLASH OR PROTRUSIONS.
INTERLEAD FLASH OR PROTRUSIONS SHALL NOT EXCEED 0.152mm (.006") PER SIDE
5. LEAD COPLANARITY (BOTTOM OF LEADS AFTER FORMING) SHALL BE 0.102mm (.004") MAX

PACKAGE DESCRIPTION

**MS Package
10-Lead Plastic MSOP**

(Reference LTC DWG # 05-08-1661 Rev F)

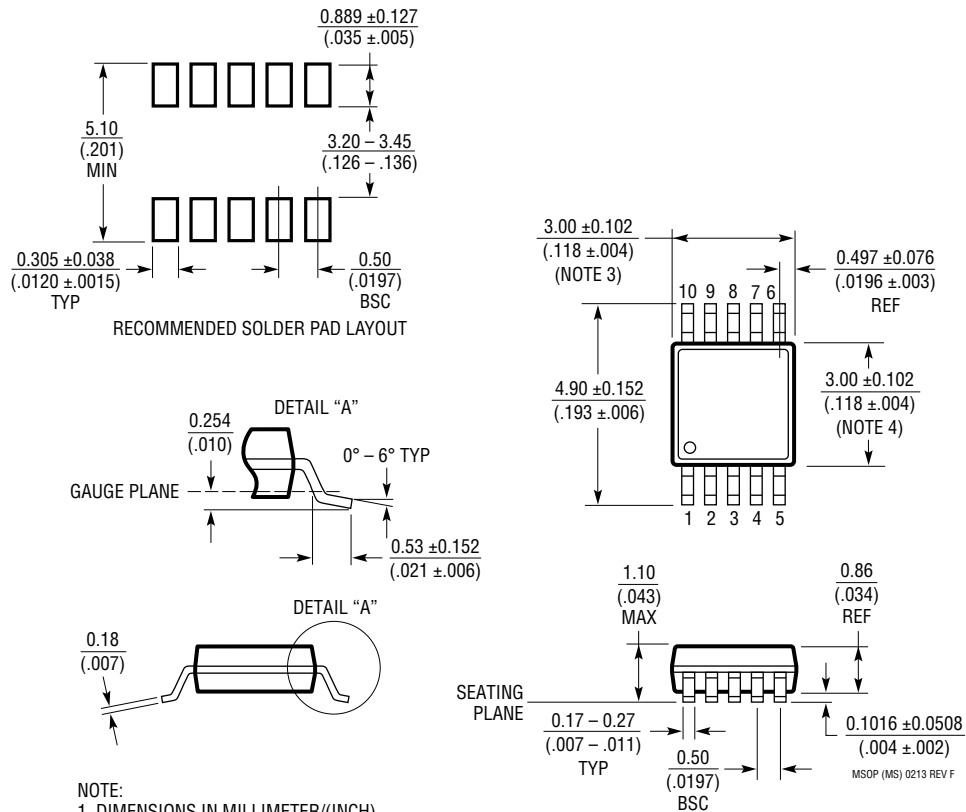

- NOTE:
1. DIMENSIONS IN MILLIMETER/(INCH)
 2. DRAWING NOT TO SCALE
 3. DIMENSION DOES NOT INCLUDE MOLD FLASH, PROTRUSIONS OR GATE BURRS.
MOLD FLASH, PROTRUSIONS OR GATE BURRS SHALL NOT EXCEED 0.152mm (.006") PER SIDE
 4. DIMENSION DOES NOT INCLUDE INTERLEAD FLASH OR PROTRUSIONS.
INTERLEAD FLASH OR PROTRUSIONS SHALL NOT EXCEED 0.152mm (.006") PER SIDE
 5. LEAD COPLANARITY (BOTTOM OF LEADS AFTER FORMING) SHALL BE 0.102mm (.004") MAX

PACKAGE DESCRIPTION

MS Package
16-Lead Plastic MSOP
 (Reference LTC DWG # 05-08-1669 Rev A)

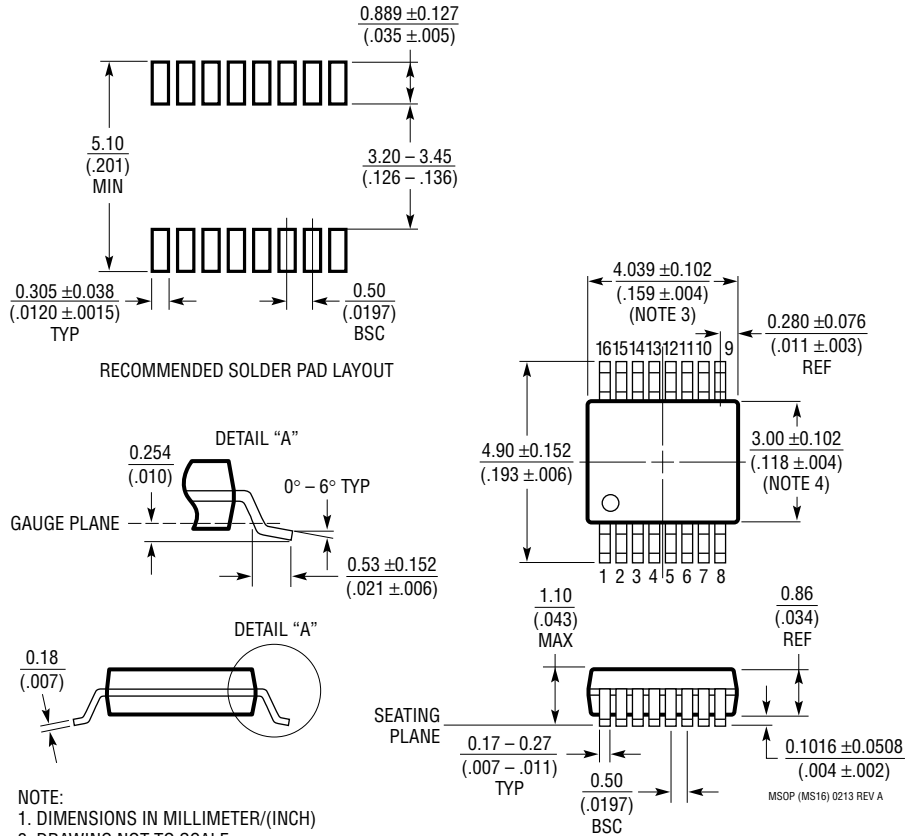

- NOTE:
1. DIMENSIONS IN MILLIMETER/(INCH)
 2. DRAWING NOT TO SCALE
 3. DIMENSION DOES NOT INCLUDE MOLD FLASH, PROTRUSIONS OR GATE BURRS.
MOLD FLASH, PROTRUSIONS OR GATE BURRS SHALL NOT EXCEED 0.152mm (.006") PER SIDE
 4. DIMENSION DOES NOT INCLUDE INTERLEAD FLASH OR PROTRUSIONS.
INTERLEAD FLASH OR PROTRUSIONS SHALL NOT EXCEED 0.152mm (.006") PER SIDE
 5. LEAD COPLANARITY (BOTTOM OF LEADS AFTER FORMING) SHALL BE 0.102mm (.004") MAX

MSOP (MS16) 0213 REV A

PACKAGE DESCRIPTION

DC8 Package
8-Lead Plastic DFN (2mm × 2mm)
 (Reference LTC DWG # 05-08-1719 Rev A)

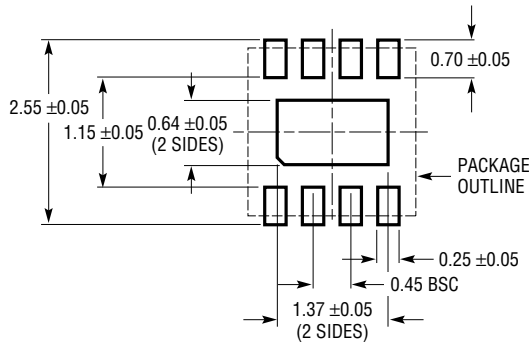

RECOMMENDED SOLDER PAD PITCH AND DIMENSIONS
 APPLY SOLDER MASK TO AREAS THAT ARE NOT SOLDERED

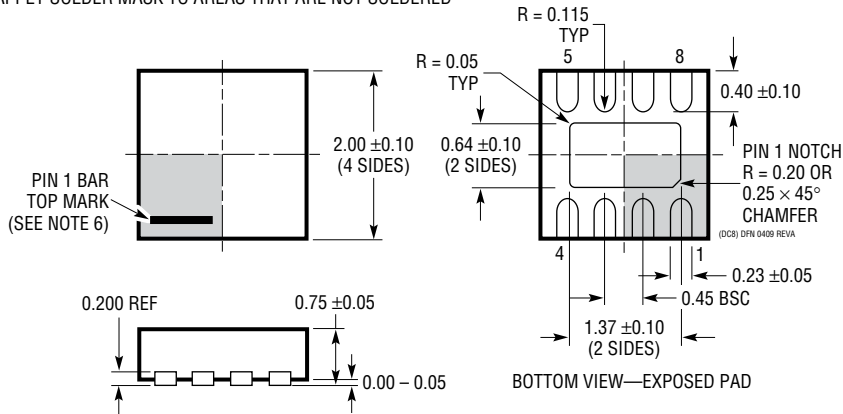

- NOTE:
1. DRAWING IS NOT A JEDEC PACKAGE OUTLINE
 2. DRAWING NOT TO SCALE
 3. ALL DIMENSIONS ARE IN MILLIMETERS
 4. DIMENSIONS OF EXPOSED PAD ON BOTTOM OF PACKAGE DO NOT INCLUDE MOLD FLASH. MOLD FLASH, IF PRESENT, SHALL NOT EXCEED 0.15mm ON ANY SIDE
 5. EXPOSED PAD SHALL BE SOLDER PLATED
 6. SHADED AREA IS ONLY A REFERENCE FOR PIN 1 LOCATION ON THE TOP AND BOTTOM OF PACKAGE

REVISION HISTORY

REV	DATE	DESCRIPTION	PAGE NUMBER
A	9/10	Revised A_V Conditions in 5V Electrical Characteristics and 1.8V Electrical Characteristics sections	4, 5
		Revised I_S MAX values in 5V Electrical Characteristics section	4
		Revised I_{SC} MIN values in 1.8V Electrical Characteristics section	6
B	9/11	Updated the Features and Description sections.	1
		Added C-, H-, and I-grades to the Absolute Maximum Ratings and Order Information sections.	2, 3
		Updated 5V and 1.8V Electrical Characteristics sections.	3 to 6
		Revised the title of curve G32 in the Typical Performance Characteristics section.	8
		Revised Figure 6 in the Typical Applications section.	17
		Revised the Typical Application drawing on the back page.	24
C	7/15	Added 2mm × 2mm × 0.8mm DFN package	2, 3, 24
D	11/15	Added 2mm × 2mm × 0.8mm DFN package for LTC6255	2, 3, 23
E	6/18	Obsoleted KC package option	1 to 3, 17 to 24

TYPICAL APPLICATION

2µs Rise Time Analog 1A Pulsed LED Current Driver.
LTC6255 Applied as a LED Current Driver with 2µs Rise Time

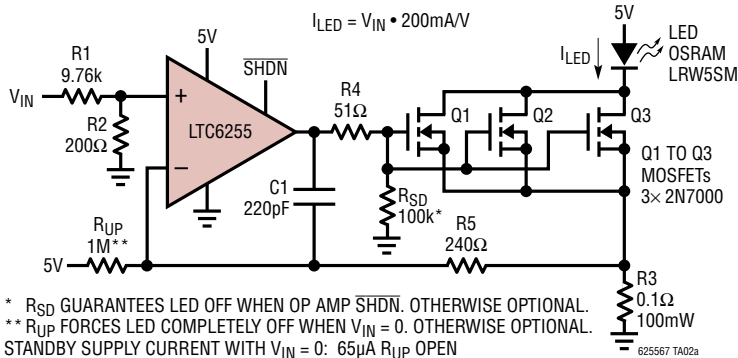

10% TO 90% RISE TIME: 10mA TO 1A, 2µs
 0mA TO 1A, ADD 2.7µs DELAY

Time Domain Response Showing 2µs Rise Time. Top Waveform Is V_{IN} . Middle Waveform Is the 10mA to 1A Step Measured at R3, then the 0mA to 1A Step Showing Extra 2.7µs Delay When Recovering From 0mA

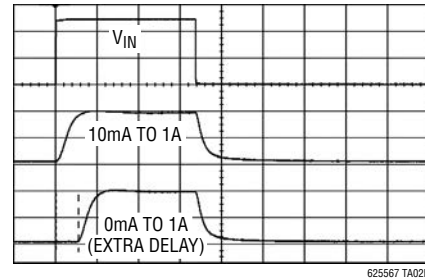

RELATED PARTS

PART NUMBER	DESCRIPTION	COMMENTS
LTC6246/LTC6247/LTC6248	180MHz, 1µA, Power Efficient Rail-to-Rail Op Amps	180MHz GBW, 1mA, 500µV V_{OS} , RR In/Out, 2.5V to 5.25V, 90V/µs Slew Rate
LT1498/LT1499	10MHz, 6V/µs, Dual/Quad, Rail-to-Rail Input and Output, Precision C-Load Op Amps	10MHz GBW, 1.7mA, 475µV V_{OS} , RR In/Out, 2.2V to ±15V, 10nF C_{LOAD}
LTC6081/LTC6082	Precision Dual/Quad CMOS Rail-to-Rail Input/Output Amplifiers	3.6MHz GBW, 330µA, 70µV V_{OS} , RR In/Out, 2.7V to 5.5V, 100dB CMRR
LTC2050/LTC2051/LTC2052	Zero-Drift Operational Amplifiers in SOT-23	3MHz GBW, 800µA, 3µV V_{OS} , V^- to $V^+ - 1V$ In, RR Out, 2.7V to 6V, 130dB CMRR/PSRR
LTC1050/LTC1051/LTC1052	Precision Zero-Drift, Operational Amplifier with Internal Capacitors	2.5MHz GBW, 1mA, 5µV V_{OS} , V^- to $V^+ - 2.3V$ In, RR Out, 4.75V to 16V, 120dB CMRR, 125dB PSRR
LTC6084/LTC6085	Dual/Quad 1.5MHz, Rail-to-Rail, CMOS Amplifiers	1.5MHz GBW, 110µA, 750µV V_{OS} , RR In/Out, 2.5V to 5.5V
LT1783	1.25MHz, Over-The-Top® Micropower, Rail-to-Rail Input and Output Op Amp in SOT-23	1.25MHz GBW, 300µA, 800µV V_{OS} , RR In/Out, 2.5V to 18V
LT1637/LT1638/LT1639	1.1MHz, 0.4V/µs Over-The-Top Micropower, Rail-to-Rail Input and Output Op Amps	1.1MHz GBW, 250µA, 350µV V_{OS} , RR In/Out, 2.7V to 44V, 110dB CMRR
LTC2054/LTC2055	Single/Dual Micropower Zero-Drift Operational Amplifiers	500kHz GBW, 150µA, 3µV V_{OS} , V^- to $V^+ - 0.5V$ In, RR Out, 2.7V to 6V
LT6010/LT6011/LT6012	135µA, 14nV/√Hz, Rail-to-Rail Output Precision Op Amp with Shutdown	330kHz GBW, 135µA, 35µV V_{OS} , $V^- + 1.0V$ to $V^+ - 1.2V$ In, RR Out, 2.7V to 36V
LT1782	Micropower, Over-The-Top, SOT-23, Rail-to-Rail Input and Output Op Amp	200kHz GBW, 55µA, 800µV V_{OS} , RR In/Out, 2.5V to 18V
LT1636	Over-The-Top, Micropower Rail-to-Rail, Input and Output Op Amp	200kHz GBW, 50µA, 225µV V_{OS} , RR In/Out, 2.7V to 44V, -40°C to 125°C
LT1490A/LT1491A	Dual/Quad Over-The-Top, Micropower Rail-to-Rail Input and Output Op Amps	200kHz GBW, 50µA, 500µV V_{OS} , RR In/Out, 2V to 44V
LT2178/LT2179	17µA Max, Dual and Quad, Single Supply, Precision Op Amps	85kHz GBW, 17µA, 70µV V_{OS} , RR In/Out, 5V to 44V
LT6000/LT6001/LT6002	Single, Dual and Quad, 1.8V, 13µA Precision Rail-to-Rail Op Amps	50kHz GBW, 16µA, 600µV $V_{OS(MAX)}$, RR In/Out, 1.8V to 18V

X-ON Electronics

Largest Supplier of Electrical and Electronic Components

Click to view similar products for [Precision Amplifiers](#) category:

Click to view products by [Analog Devices](#) manufacturer:

Other Similar products are found below :

[561681F](#) [LT6005HGN#PBF](#) [LT6238CGN#PBF](#) [LT6238HGN#PBF](#) [OP05CN8#PBF](#) [OP227GN#PBF](#) [LT6020IDD-1#PBF](#) [LT1124CS8#TR](#)
[NCV20166SN2T1G](#) [NCS20166SN2T1G](#) [NCS21802MUTBG](#) [LT1637MPS8](#) [LT1498IS8](#) [LT1492CS8](#) [TLC27L7CP](#) [TLV2473CDR](#)
[LMP2234AMA/NOPB](#) [LMP7707MA/NOPB](#) [5962-8859301M2A](#) [LMP2231AMAE/NOPB](#) [LMP2234AMTE/NOPB](#) [LMC6022IM/NOPB](#)
[LMC6024IM/NOPB](#) [LMC6081IMX/NOPB](#) [LMP2011MA/NOPB](#) [LMP2231AMFE/NOPB](#) [LMP2232BMA/NOPB](#) [LMP2234AMAE/NOPB](#)
[LMP7717MAE/NOPB](#) [LMV2011MA/NOPB](#) [LT1013DDR](#) [TL034ACDR](#) [TLC2201AMDG4](#) [TLE2024BMDWG4](#) [TS9222IYDT](#)
[TLV2474AQDRG4Q1](#) [TLV2472QDRQ1](#) [TLC4502IDR](#) [TLC27M2ACP](#) [TLC2652Q-8DG4](#) [OPA2107APG4](#) [TL054AIDR](#) [AD8619WARZ-](#)
[R7](#) [TLC272CD](#) [AD8539ARMZ](#) [LTC6084HDD#PBF](#) [LT1638CMS8#TRPBF](#) [LTC1050CN8#PBF](#) [LT1112ACN8#PBF](#) [LT1996AIDD#PBF](#)