

# PD57/60/86-1378 Hardware Manual

Hardware Version V1.10 | Document Revision V1.21 • 2020-APR-24

The PD57/60/86-1378 is an easy to use PANdrive™ smart stepper drive. The drive is controlled via a CAN bus interface and comes with two firmware options – TMCL™ and CANopen®. With its built-in high resolution encoder, the PD57/60/86-1378 is mainly designed for closed-loop operation, but also features StealthChop™ for absolute silent motor control, SpreadCycle™ for high speed stepper motor commutation as well as StallGuard2™ and CoolStep™. The fully integrated hardware motion controller supports trapezoidal ramps, SixPoint™ ramps and s-shaped ramps.



## Features

- PANdrive™ smart motor
- Supply Voltage +12 to +52V DC
- CAN bus interface
- TMCL™ or CANopen® protocol
- Integrated ramp motion controller with different ramp types
- StealthChop™ silent PWM mode
- SpreadCycle™ smart mixed decay
- StallGuard2™ load detection
- CoolStep™ automatic current scaling

## Applications

- Lab-Automation
- Robotics
- CNC
- Manufacturing
- Factory Automation

## Simplified Block Diagram

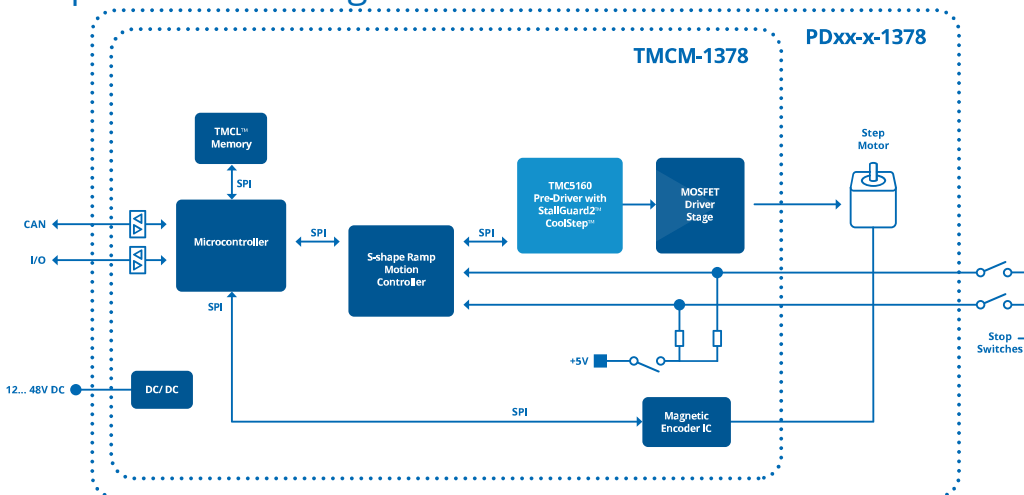

# Contents

<b>1</b>	<b>Features</b>	<b>3</b>
1.1	General Features	3
1.2	TRINAMIC's Unique Features	4
1.2.1	stealthChop™	4
1.2.2	spreadCycle™	4
1.2.3	stallGuard2	4
1.2.4	coolStep	5
<b>2</b>	<b>Order Codes</b>	<b>6</b>
<b>3</b>	<b>Mechanical and Electrical Interfacing</b>	<b>7</b>
3.1	PD57/60/86-1378 Dimensions	7
3.2	PD57/60/86-1378 Dimensions and Weight	7
3.3	PD57/60/86-1378 Motor Parameters	8
3.4	PD57/60/86-1378 Torque Curves	10
<b>4</b>	<b>Connectors and LEDs</b>	<b>13</b>
4.1	Power Supply Connector	13
4.2	I/O Connector	14
4.3	CAN Connection	14
4.4	Motor Connector	15
4.5	LEDs	16
<b>5</b>	<b>Functional Description</b>	<b>17</b>
5.1	Typical Application Wiring	17
5.2	Inputs	17
<b>6</b>	<b>Operational Ratings and Characteristics</b>	<b>18</b>
6.1	Absolute Maximum Ratings	18
6.2	Electrical Characteristics (Ambient Temperature 25° C)	18
6.3	I/O Ratings (Ambient Temperature 25° C)	18
6.4	Functional Characteristics	19
6.5	Other Requirements	19
<b>7</b>	<b>Abbreviations used in this Manual</b>	<b>19</b>
<b>8</b>	<b>Figures Index</b>	<b>20</b>
<b>9</b>	<b>Tables Index</b>	<b>21</b>
<b>10</b>	<b>Supplemental Directives</b>	<b>22</b>
10.1	Producer Information	22
10.2	Copyright	22
10.3	Trademark Designations and Symbols	22
10.4	Target User	22
10.5	Disclaimer: Life Support Systems	22
10.6	Disclaimer: Intended Use	22
10.7	Collateral Documents & Tools	23
<b>11</b>	<b>Revision History</b>	<b>24</b>
11.1	Hardware Revision	24
11.2	Document Revision	24



# 1 Features

The PANdrives™ PD57/60/86-1378 are full mechatronic solutions with state of the art feature set. They are highly integrated and offer convenient handling via CAN interface. Each PD57/60/86-1378 includes a stepper motor, driver electronics, and a fully featured hardware motion controller. It can be used in many decentralized applications and has been designed for 0.55...7 Nm maximum holding torque and 24V DC or 48V DC nominal supply voltage. With the built-in high resolution magnetic encoder and the advanced ramp generator chip it is mainly designed for closed-loop operation. With StealthChop™ the PD57/60/86-1378 offers absolutely silent and smooth motor operation for lower and medium velocities. With SpreadCycle™, the PD57/60/86-1378 offers a high performance current controlled chopper mode for highest velocities with perfect zero crossing performance. With StallGuard2™, a sensorless load detection feature is provided for automatic end step detection and load monitoring. StallGuard2™ is also used for the automatic current scaling feature CoolStep™. The PD57/60/86-1378 is equipped with a CAN bus interface and three digital inputs.

## 1.1 General Features

### Main Characteristics

- Supply Voltage +24V or +48V nominal (+10V...+52V DC).
- up to 9A RMS phase current (depending on the motor).
- Highest micro step resolution, up to 256 micro steps per full step.
- Available with enclosure and mounted to NEMA23 / 57mm or NEMA24 / 60mm flange size motor.
- Permanent onboard TMCL program and parameter storage.
- Different kinds of ramps: trapezoidal ramps, six-point ramps and S-shaped ramps.
- Closed loop operation possible.
- Noiseless StealthChop™ chopper mode for slow to medium velocities.
- High performance SpreadCycle™ chopper mode.
- High-precision sensorless load measurement with StallGuard2™.

### I/Os

- Home and reference switch inputs.
- Enable input to power-on/-off driver H-bridges.

### CAN Bus Interface

- Standard CAN Bus Interface for control and configuration
- CAN bit rate of 20...1000kBit/s
- TMCL™ based protocol with TMCL firmware option
- CANopen® protocol with DS402 device profile with CANopen firmware option



## 1.2 TRINAMIC's Unique Features

### 1.2.1 stealthChop™

stealthChop is an extremely quiet mode of operation for low and medium velocities. It is based on a voltage mode PWM. During standstill and at low velocities, the motor is absolutely noiseless. Thus, stealthChop operated stepper motor applications are very suitable for indoor or home use. The motor operates absolutely free of vibration at low velocities. With stealthChop, the motor current is applied by driving a certain effective voltage into the coil, using a voltage mode PWM. There are no more configurations required except for the regulation of the PWM voltage to yield the motor target current.

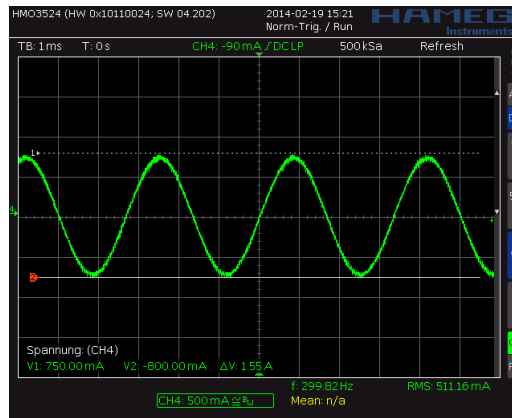

Figure 1: Motor coil sine wave current using stealthChop (measured with current probe)

### 1.2.2 spreadCycle™

The spreadCycle chopper is a high-precision, hysteresis-based, and simple to use chopper mode, which automatically determines the optimum length for the fast-decay phase. Several parameters are available to optimize the chopper to the application. spreadCycle offers optimal zero crossing performance compared to other current controlled chopper algorithms and thereby allows for highest smoothness. The true target current is powered into the motor coils.

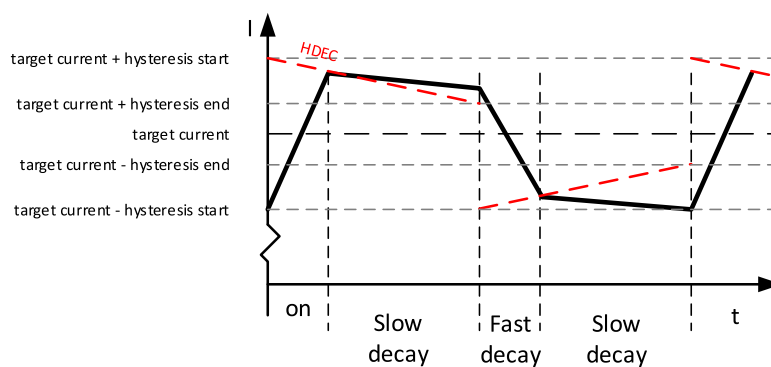

Figure 2: spreadCycle principle

### 1.2.3 stallGuard2

stallGuard2 is a high-precision sensorless load measurement using the back EMF of the motor coils. It can be used for stall detection as well as other uses at loads below those which stall the motor. The



stallGuard2 measurement value changes linearly over a wide range of load, velocity, and current settings. At maximum motor load, the value reaches zero or is near zero. This is the most energy-efficient point of operation for the motor.

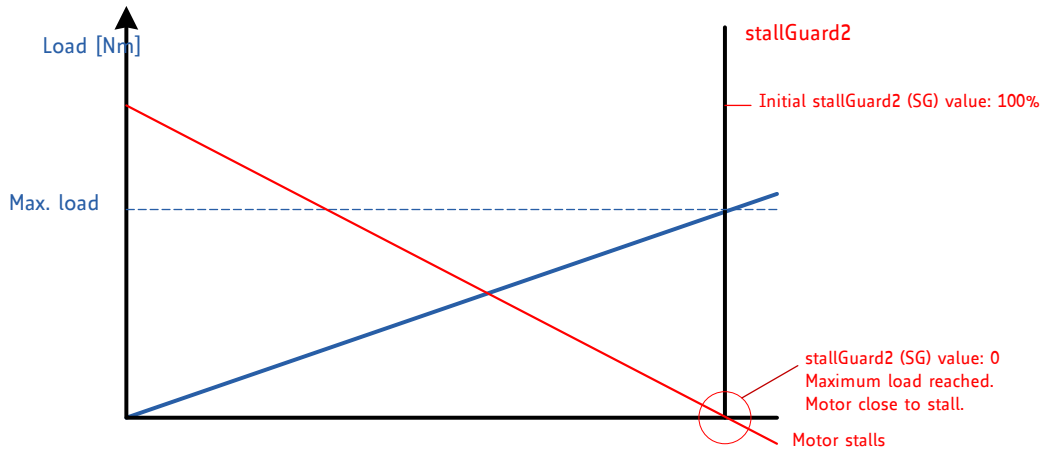

Figure 3: stallGuard2 Load Measurement as a Function of Load

### 1.2.4 coolStep

coolStep is a load-adaptive automatic current scaling based on the load measurement via stallGuard2. coolStep adapts the required current to the load. Energy consumption can be reduced by as much as 75%. coolStep allows substantial energy savings, especially for motors which see varying loads or operate at a high duty cycle. Because a stepper motor application needs to work with a torque reserve of 30% to 50%, even a constant-load application allows significant energy savings because coolStep automatically enables torque reserve when required. Reducing power consumption keeps the system cooler, increases motor life, and allows for cost reduction.

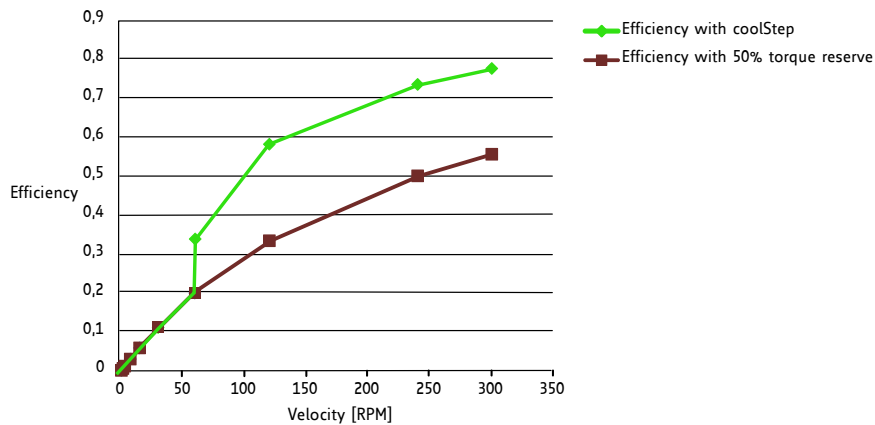

Figure 4: Energy Efficiency Example with coolStep



## 2 Order Codes

Order Code	Description	Size (LxWxH)
PD57-1-1378-TMCL	PANdrive, 0.55Nm, 3A RMS, +48V DC, CAN interface, TMCL firmware	60mm x 60mm x 65mm
PD57-2-1378-TMCL	PANdrive, 1.01Nm, 3A RMS, +48V DC, CAN interface, TMCL firmware	60mm x 60mm x 75mm
PD60-3-1378-TMCL	PANdrive, 2.1Nm, 3A RMS, +48V DC, CAN interface, TMCL firmware	60mm x 60mm x 89mm
PD60-4-1378-TMCL	PANdrive, 3.1Nm, 3A RMS, +48V DC, CAN interface, TMCL firmware	60mm x 60mm x 110mm
PD60-4H-1378-TMCL	PANdrive, 3Nm, 9A RMS, +48V DC, CAN interface, TMCL firmware	60mm x 60mm x 110mm
PD86-3-1378-TMCL	PANdrive, 7Nm, 5.5A RMS, +48V DC, CAN interface, TMCL firmware	86mm x 86mm x 120mm
PD57-1-1378-CANopen	PANdrive, 0.55Nm, 3A RMS, +48V DC, CAN interface, CANopen firmware	60mm x 60mm x 65mm
PD57-2-1378-CANopen	PANdrive, 1.01Nm, 3A RMS, +48V DC, CAN interface, CANopen firmware	60mm x 60mm x 75mm
PD60-3-1378-CANopen	PANdrive, 2.1Nm, 3A RMS, +48V DC, CAN interface, CANopen firmware	60mm x 60mm x 89mm
PD60-4-1378-CANopen	PANdrive, 3.1Nm, 3A RMS, +48V DC, CAN interface, CANopen firmware	60mm x 60mm x 110mm
PD60-4H-1378-CANopen	PANdrive, 3Nm, 9A RMS, +48V DC, CAN interface, CANopen firmware	60mm x 60mm x 110mm
PD86-3-1378-CANopen	PANdrive, 7Nm, 5.5A RMS, +48V DC, CAN interface, CANopen firmware	86mm x 86mm x 120mm

Table 1: Order codes modules (electronics + enclosure) and PANdrives™

Order Code	Description
PD-1378-CABLE	Cable loom for PDxx-1378: <ul style="list-style-type: none"> <li>• 1x cable loom for power connector with 2-pin JST VH series connector</li> <li>• 1x cable loom for I/O connector with 8-pin JST EH series connector</li> </ul>

Table 2: Order codes cable loom



### 3 Mechanical and Electrical Interfacing

#### 3.1 PD57/60/86-1378 Dimensions

The PD57/60/86-1378 includes the TCMC-1378 stepper motor controller/driver module (electronics + encapsulating enclosure) and a NEMA23 / 57mm flange size, NEMA24 / 60mm flange size or NEMA34 / 86mm flange size bipolar stepper motor. Currently, there is a choice between two NEMA23 / 57mm flange size, three NEMA24 / 60mm flange size and one NEMA34 / 86mm flange size stepper motors with different lengths and different holding torques. The stepper motors are rated for coil currents between 2.8A RMS and 9A RMS - perfectly fitting to the TCMC-1378 electronics.

The dimensions of the controller/driver unit are approx. 60mm x 60mm x 24.5mm (TCMC-1378 electronics + encapsulating enclosure). There are four mounting holes for M3 screws for mounting the PD57/60/86-1378. These mounting holes are located in the bottom / base plate and accessible after removing the top cover (see 5, right figure, mounting holes marked red). Two of them at opposite positions can be used for mounting the module to the backside of our NEMA23 stepper motors (screw/thread length depends on motor size). The other two can be used for mounting the module to the backside of our NEMA24 stepper motors (screw/thread length depends on motor size).

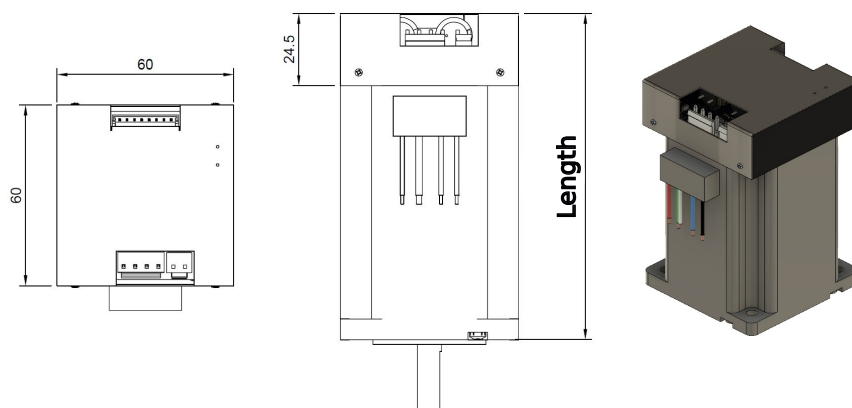

Figure 5: PD57/60/86-1378 all dimensions in mm

#### 3.2 PD57/60/86-1378 Dimensions and Weight

When mounted to the stepper motor the overall size of the PANdrive is the housing height plus motor body size.

Order Code	Length in mm	Weight in g
PD57-1-1378	65	≈ 520
PD57-2-1378	75	≈ 720
PD60-3-1378	89	≈ 1270
PD60-4-1378	110	≈ 1470
PD60-4H-1378	110	≈ 1470
PD86-3-1378	120	≈ 1470

Table 3: Length and weight



### 3.3 PD57/60/86-1378 Motor Parameters

Specifications	Unit	PD57-1-1378	PD57-2-1378	PD60-3-1378	PD60-4-1378
Step angle	°	1.8	1.8	1.8	1.8
Step angle accuracy	%	+/-5	+/-5	+/-5	+/-5
Ambient temperature	°C	-20...+50	-20...+50	-20...+50	-20...+50
Max. motor temperature	°C	80	80	80	80
Shaft radial play (450g load)	mm	0.02	0.02	0.02	0.02
Shaft axial play (450g load)	mm	0.08	0.08	0.08	0.08
Max radial force (20mm from front flange)	N	57	57	57	57
Max axial force	N	15	15	15	15
Rated voltage	V	2.0	2.3	3.36	4.17
Rated phase current	A	2.8	2.8	2.8	2.8
Phase resistance at 20°C	Ω	0.7	0.83	1.2	1.5
Phase inductance (typ.)	mH	1.4	2.2	4.6	6.8
Holding torque	Nm	0.55	1.01	2.1	3.1
Insulation class		B	B	B	B
Rotor inertia	g cm <sup>2</sup>	120	275	570	840
Weight	kg	0.45	0.65	1.2	1.4

Table 4: NEMA23 / 57mm and NEMA24 / 60mm stepper motor technical data

Specifications	Unit	PD60-4H-1378	PD86-3-1378
Step angle	°	1.8	1.8
Step angle accuracy	+/-5	+/-5	+/-5
Ambient temperature	°C	-20...+50	-20...+50
Max. motor temperature	°C	80	80
Shaft radial play (450g load)	mm	0.02	0.02
Shaft axial play (450g load)	mm	0.08	0.08
Max radial force (20mm from front flange)	N	57	220
Max axial force	N	15	60
Rated voltage	V	2.1	2.56
Rated phase current	A	9	5.5
Phase resistance at 20°C	Ω	0.15	0.45
Phase inductance (typ.)	mH	0.6	4.5





Specifications	Unit	PD60-4H-1378	PD86-3-1378
Holding torque	Nm	3.0	7.0
Insulation class		B	B
Rotor inertia	g cm <sup>2</sup>	840	2700
Weight	kg	1.4	2.87

*Table 5: NEMA24 / 60mm and NEMA34 / 86mm stepper motor technical data*



### 3.4 PD57/60/86-1378 Torque Curves

The following diagrams show the torque vs. speed curves for the PD57-1-1378, the PD57-2-1378, the PD60-3-1378 and the PD60-4-1378 with SpreadCycle™ chopper mode selected, 48V supply voltage and rated motor current.

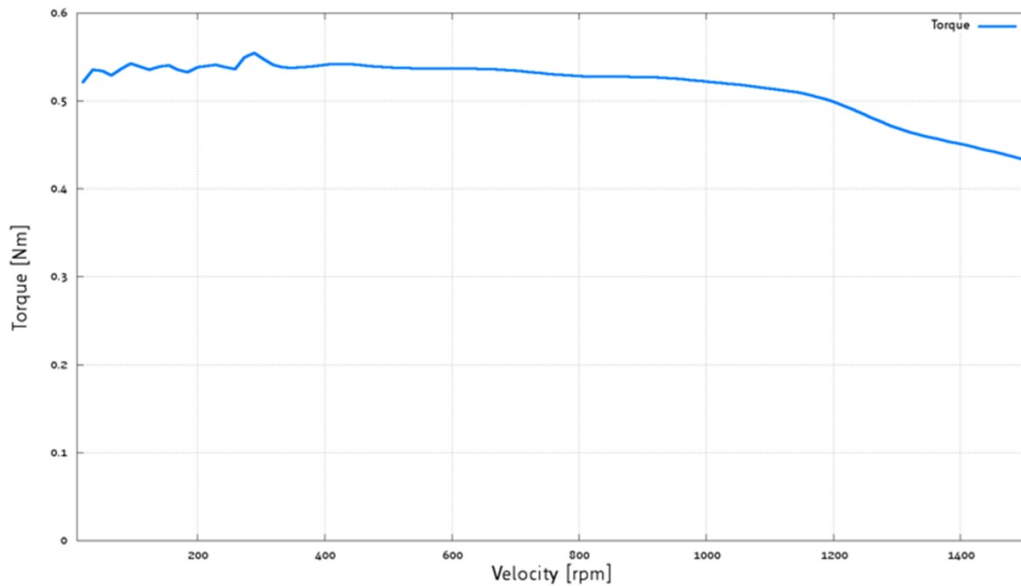

Figure 6: PD57-1-1378 torque vs. velocity 48V / 2.8A, 256µsteps

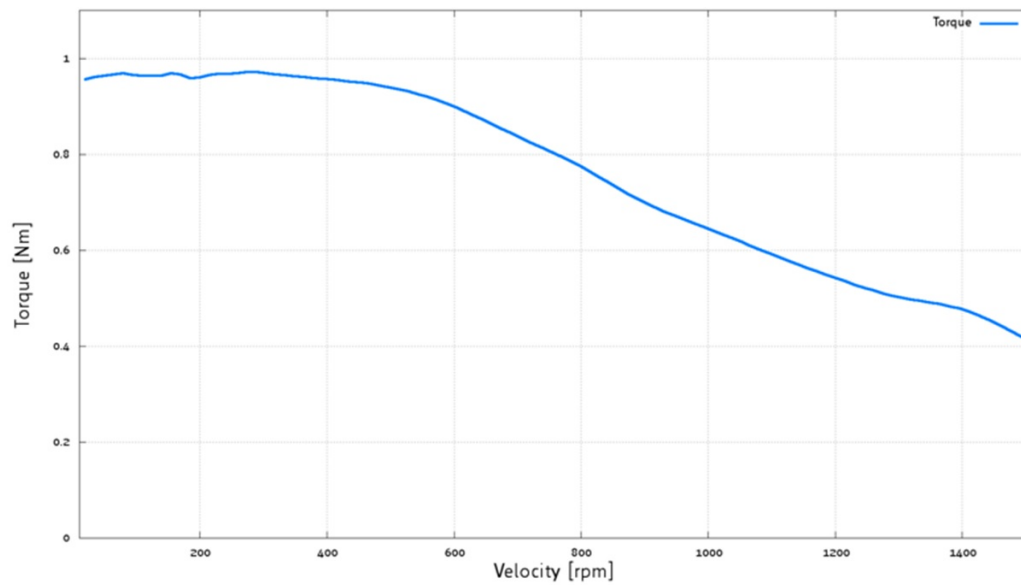

Figure 7: PD57-2-1378 torque vs. velocity 48V / 2.8A, 256µsteps



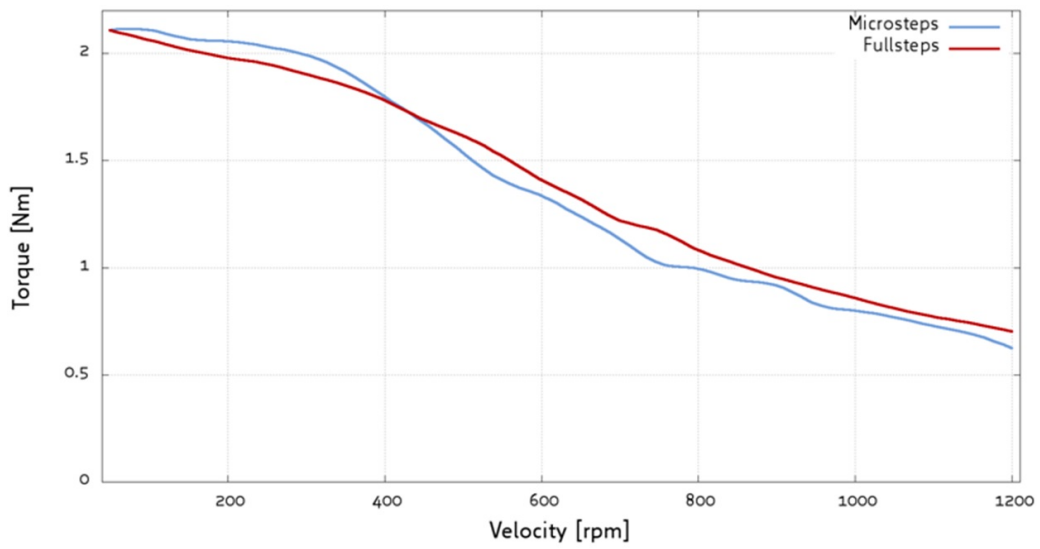

Figure 8: PD60-3-1378 torque vs. velocity 48V / 2.8A, 256 $\mu$ steps

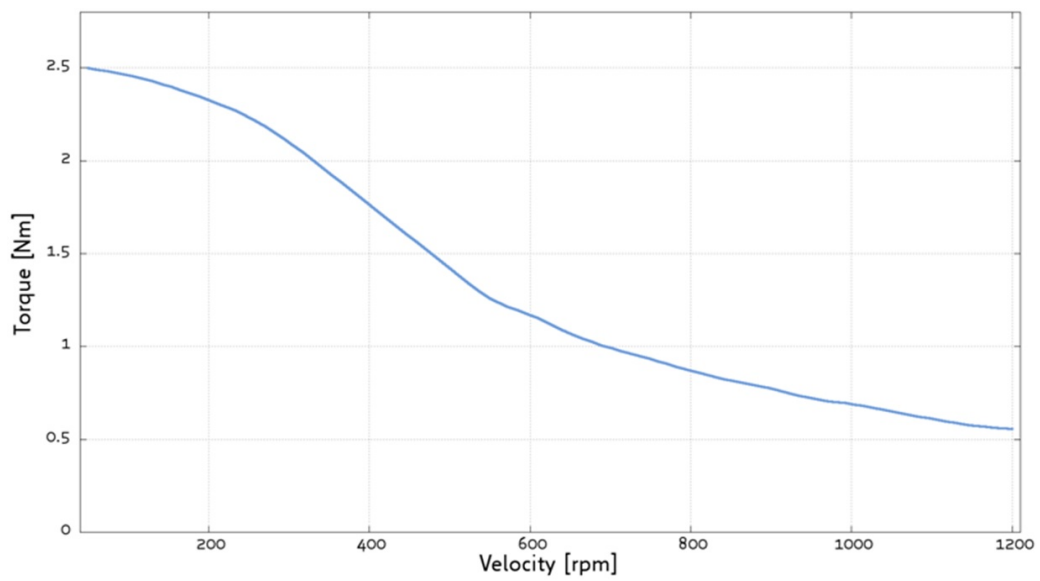

Figure 9: PD60-4-1378 torque vs. velocity 48V / 2.8A, 256 $\mu$ steps



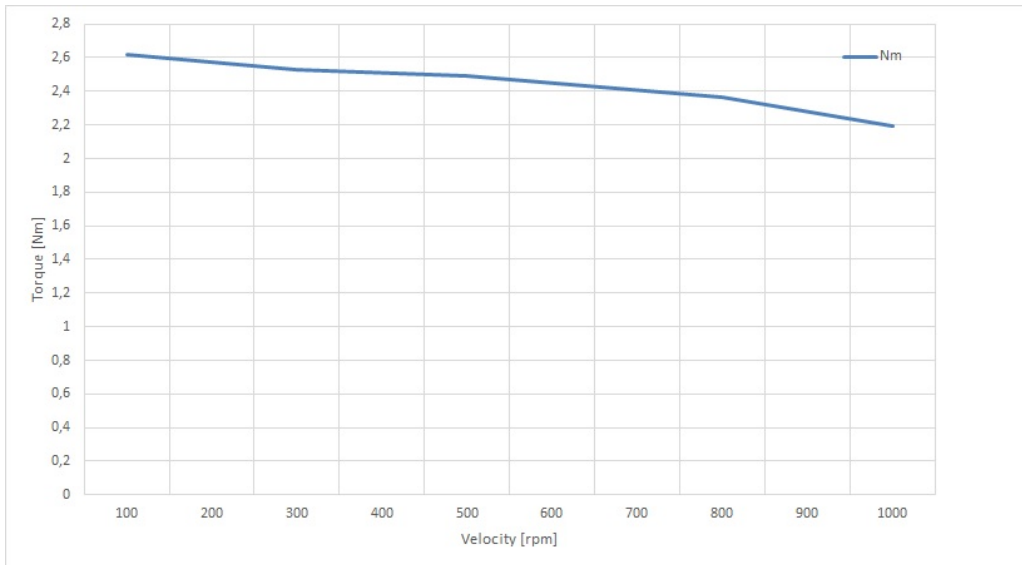

Figure 10: PD60-4H-1378 torque vs. velocity 48V / 9A, 256 $\mu$ steps

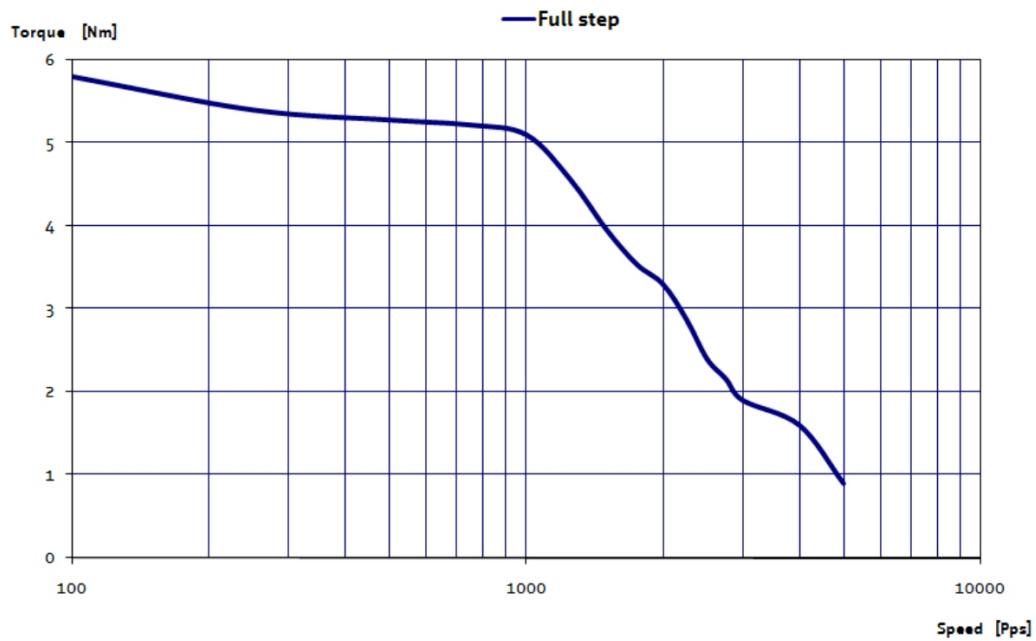

Figure 11: PD86-3-1378 torque vs. velocity 48V / 5.5A, 256 $\mu$ steps



## 4 Connectors and LEDs

The PD57/60/86-1378 is equipped with three connectors – one eight-pin connector for communication (CAN) and additional I/O (home switch and stop switches as well as one general purpose output), one-four pin connector for connecting the motor and one two-pin connector for connecting to the power supply.

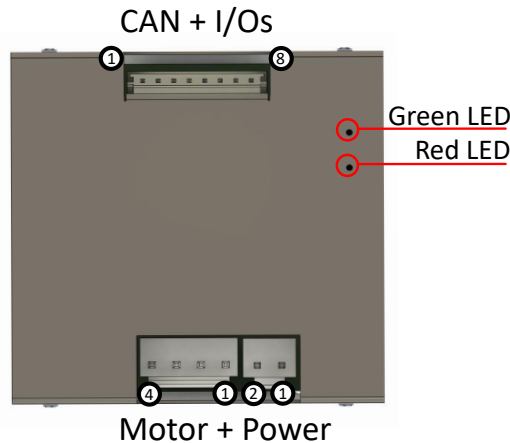

Figure 12: PD57/60/86-1378 connectors

Overview of connector and mating connector types:

Label	Connector type	Mating connector type
Power connector	JST B2P-VH (JST VH series, 2pins, 3.96mm pitch)	Connector housing: JST VHR-2N Contacts: JST SVH-41T-P1.1 Wire: 1.25mm <sup>2</sup> , AWG 16
CAN and I/O connector	JST B8B-EH-A (JST EH series, 8pins, 2.5mm pitch)	Connector housing: JST EHR-8 Contacts: JST SEH-001T-P0.6 Wire: 0.33mm <sup>2</sup> , AWG 22
Motor connector	JST B4P-VH (JST VH series, 4pins, 3.96mm pitch)	Connector housing: JST VHR-4N Contacts: JST SVH-41T-P1.1 Wire: 1.25mm <sup>2</sup> , AWG 16

Table 6: Connector and mating connectors

### 4.1 Power Supply Connector

Pin nu.	Pin name	Description
1	GND	Ground connection
2	+48V	Supply power connection

Table 7: PD57/60/86-1378 Power supply connector pin assignment



## 4.2 I/O Connector

Pin no.	Pin name	Description
1	CAN_H	Differential CAN bus signal (non-inverting)
2	CAN_L	Differential CAN bus signal (inverting)
3	GND	Signal ground connection
4	+5V	5V output, 100mA maximum load, e.g. for end / home switch circuit or external encoder supply
5	HOME (GPIO)	General purpose input 0 and HOME switch input (+5V TTL compatible 10k pull-up to +5V).
6	REFL (GPI1)	General purpose input 1 and stop switch input REFL / STOP_L.
7	REFR (GPI2)	General purpose input 2 and stop switch input REFR / STOP_R.
8	ENN (GPI3)	ENABLE NOT input (active low) for driver stage, 0 = enabled, 1 = disabled (+5V TTL compatible, internal 10k pull-up to +5V)

Table 8: PD57/60/86-1378 I/O connector pin assignment

### NOTICE

**Always keep the power supply voltage below the upper limit of 52V!** Otherwise the driver electronics will be seriously damaged. Especially, when the selected operating voltage is near the upper limit a regulated power supply is highly recommended.

### NOTICE

**Add external power supply capacitors!** It is recommended to connect an electrolytic capacitor of significant size (e.g. 4700 $\mu$ F/63V) to the power supply lines next to the PD57/60/86-1378!

Rule of thumb for size of electrolytic capacitor:  $C = \frac{1000\mu F}{A} \times I_{SUPPLY}$

In addition to power stabilization (buffer) and filtering this added capacitor will also reduce any voltage spikes which might otherwise occur from a combination of high inductance power supply wires and the ceramic capacitors. In addition it will limit slew-rate of power supply voltage at the module. The low ESR of ceramic-only filter capacitors may cause stability problems with some switching power supplies.

### NOTICE

**Tie ENN to GND in order to enable driver stage!** Please note that pin 8 of the I/O connector is a driver stage enable input (active low) with an internal pull-up resistor. In order to enable motor driver stage and be able to move the motor using appropriate software commands it is necessary to tie this input to GND.

## 4.3 CAN Connection

For remote control and communication with a host system the PD57/60/86-1378 provides a CAN bus interface. For proper operation the following items should be taken into account when setting up a CAN network:



**Bus Structure** The network topology should follow a bus structure as closely as possible. That is, the connection between each node and the bus itself should be as short as possible. Basically, it should be short compared to the length of the bus.

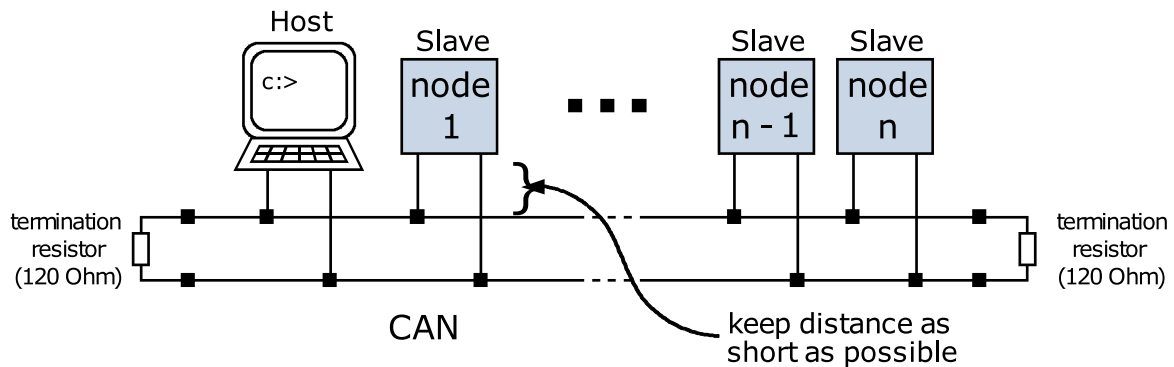

Figure 13: CAN bus structure

**Bus Termination** Especially for longer busses and/or multiple nodes connected to the bus and/or high communication speeds, the bus should be properly terminated at both ends. The PD57/60/86-1378 does not integrate any termination resistor. Therefore, 120 Ohm termination resistors at both ends of the bus have to be added externally.

**Number of Nodes** The bus transceiver used on the PD57/60/86-1378 (TJA1051) supports at least 100 nodes under optimum conditions. Practically achievable number of nodes per CAN bus highly depend on bus length (longer bus → less nodes) and communication speed (higher speed → less nodes).

**CAN Bus Adapters** To quickly connect to the PD57/60/86-1378 a PC based intergrated development environment TMCL-IDE is available. Latest release can be downloaded for free from our web site: [www.trinamic.com](http://www.trinamic.com) A number of common CAN interface adapters from different manufactures is supported from within this software. Please make sure to check our web site from time to time for the latest version of the software!

## 4.4 Motor Connector

Pin no.	Pin name	Description
1	B1	Motor phase B pin 1
2	B2	Motor phase B pin 2
3	A1	Motor phase A pin 1
4	A2	Motor phase A pin 2

Table 9: Motor connector pinning



**NOTICE**

**Do not connect or disconnect motor during operation!** Motor cable and motor inductivity might lead to voltage spikes when the motor is connected / disconnected while energized. These voltage spikes might exceed voltage limits of the driver MOSFETs and might permanently damage them. Therefore, always switch off or disconnect power supply before connecting or disconnecting the motor.

**4.5 LEDs**

The PD57/60/86-1378 includes two LEDs: one green status LED and one red error LED. See figure 14 for LED location.

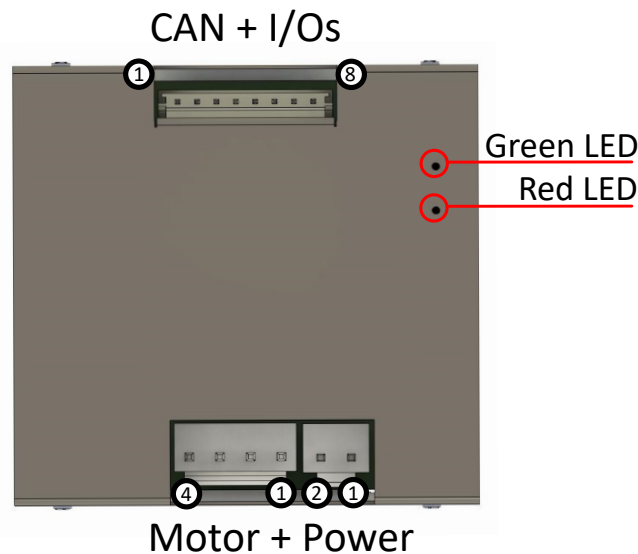

Figure 14: PD57/60/86-1378 LED colors and location

Depending on the firmware option (TMCL or CANopen), these LEDs have different functionality. Main states for TMCL:

State green LED	State red LED	Description TMCL Firmware
Flashing	off	Firmware running (normal operation mode)
Permanent on	Permanent on	Bootloader mode, firmware update supported

Table 10: LED functionality description

For CANopen firmware LED functionality has been implemented according to the CANopen® standard.





## 5 Functional Description

### 5.1 Typical Application Wiring

The PD57/60/86-1378 driver/controller's wiring is straightforward as shown in the following figure.

- Power supply must be connected to V+ and GND.
- CAN - use appropriate CAN interface adapter
- ENN - connect ENN signal to GND in order to enable driver stage

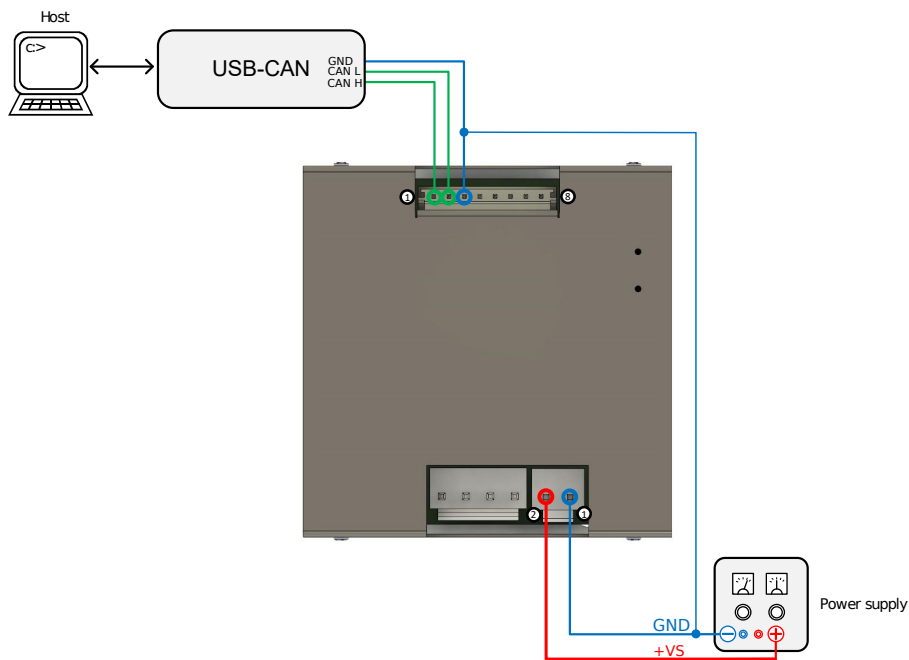

Figure 15: Typical application scenario for remote control of PD57/60/86-1378

### 5.2 Inputs

The four inputs of the PD57/60/86-1378 are +5V TTL compatible with internal pull-ups (10k) to +5V and not optically isolated.



## 6 Operational Ratings and Characteristics

### 6.1 Absolute Maximum Ratings

Parameter	Min	Max	Unit
Supply voltage	+10	+52	V
Working temperature	-20	+50	°C
Motor coil current / sine wave <b>peak</b>		12.7	A
Continuous motor current ( <b>RMS</b> )		9.0	A

#### NOTICE

Stresses above those listed under "Absolute Maximum Ratings" may cause permanent damage to the device. This is a stress rating only and functional operation of the device at those or any other conditions above those indicated in the operation listings of this specification is not implied. Exposure to maximum rating conditions for extended periods may affect device reliability.

### 6.2 Electrical Characteristics (Ambient Temperature 25° C)

Parameter	Symbol	Min	Typ	Max	Unit
Supply voltage	$V_{DD}$	10	24 or 48	52	V
Motor coil current / sine wave <b>peak</b> (chopper regulated, adjustable via TTL UART interface)	$I_{COILpeak}$	0		12.7	A
Continuous motor current ( <b>RMS</b> )	$I_{COILRMS}$	0		9.0	A
Power supply current	$I_{DD}$		$\ll I_{COIL}$	$1.4 \cdot I_{COIL}$	A

Table 12: Electrical Characteristics

### 6.3 I/O Ratings (Ambient Temperature 25° C)

Parameter	Symbol	Min	Typ	Max	Unit
Input voltage	$V_{IN}$		5	5.5	V
Low level voltage	$V_L$	0		1.5	V
High level voltage	$V_H$	3.5		5	V
Voltage at open drain output GPO (switched off)	$V_{OUT0}$	0		+30	V
Output sink current of open drain output GPO (switched on)	$I_{OUT0}$	0		100	mA

Table 13: I/O ratings



## 6.4 Functional Characteristics

Parameter	Description / Value
Control	CAN bus interface and four digital inputs for referencing, incremental encoder, and NOT_ENABLE
Communication	CAN bus interface for control and configuration, 20...1000kBit/s
Driving Mode	SpreadCycle™, StealthChop™, and constant $T_{off}$ chopper, adaptive current control via StallGuard2™ and coolstep
Stepping Resolution	Full, 1/2, 1/4, 1/8, 1/16, 1/32, 1/64, 1/128, 1/256 step

Table 14: Functional Characteristics

## 6.5 Other Requirements

Specifications	Description or Value
Cooling	Free air
Working environment	Avoid dust, water, oil mist and corrosive gases, no condensation, no frosting
Working temperature	-20° C to +50° C

Table 15: Other Requirements and Characteristics

## 7 Abbreviations used in this Manual

Abbreviation	Description
CAN	Controller Area Network
IDE	Integrated Development Environment
LED	Light Emmitting Diode
RMS	Root Mean Square value
TMCL	TRINAMIC Motion Control Language
TTL	Transistor Transistor Logic
UART	Universal Asynchronous Receiver Transmitter
USB	Universal Serial Bus

Table 16: Abbreviations used in this Manual



## 8 Figures Index

1	Motor coil sine wave current using stealthChop (measured with current probe) . . . . .	4	9	PD60-4-1378 torque vs. velocity 48V / 2.8A, 256 $\mu$ steps . . . . .	11
2	spreadCycle principle . . . . .	4	10	PD60-4H-1378 torque vs. velocity 48V / 9A, 256 $\mu$ steps . . . . .	12
3	stallGuard2 Load Measurement as a Function of Load . . . . .	5	11	PD86-3-1378 torque vs. velocity 48V / 5.5A, 256 $\mu$ steps . . . . .	12
4	Energy Efficiency Example with coolStep . . . . .	5	12	PD57/60/86-1378 connectors . . . . .	13
5	PD57/60/86-1378 all dimensions in mm . . . . .	7	13	CAN bus strcuture . . . . .	15
6	PD57-1-1378 torque vs. velocity 48V / 2.8A, 256 $\mu$ steps . . . . .	10	14	PD57/60/86-1378 LED colors and location . . . . .	16
7	PD57-2-1378 torque vs. velocity 48V / 2.8A, 256 $\mu$ steps . . . . .	10	15	Typical application scenario for remote control of PD57/60/86-1378 . . . . .	17
8	PD60-3-1378 torque vs. velocity 48V / 2.8A, 256 $\mu$ steps . . . . .	11			



## 9 Tables Index

1	Order codes modules (electronics + enclosure) and PANdrives™ . . . . .	6	8	PD57/60/86-1378 I/O connector pin assignment . . . . .	14
2	Order codes cable loom . . . . .	6	9	Motor connector pinning . . . . .	15
3	Length and weight . . . . .	7	10	LED functionality description . . . . .	16
4	NEMA23 / 57mm and NEMA24 / 60mm stepper motor technical data . . . . .	8	12	Electrical Characteristics . . . . .	18
5	NEMA24 / 60mm and NEMA34 / 86mm stepper motor technical data . . . . .	9	13	I/O ratings . . . . .	18
6	Connector and mating connectors . . . . .	13	14	Functional Characteristics . . . . .	19
7	PD57/60/86-1378 Power supply connector pin assignment . . . . .	13	15	Other Requirements and Characteristics . . . . .	19
			16	Abbreviations used in this Manual . . . . .	19
			17	Hardware Revision . . . . .	24
			18	Document Revision . . . . .	24



## 10 Supplemental Directives

### 10.1 Producer Information

### 10.2 Copyright

TRINAMIC owns the content of this user manual in its entirety, including but not limited to pictures, logos, trademarks, and resources. © Copyright 2021 TRINAMIC. All rights reserved. Electronically published by TRINAMIC, Germany.

Redistributions of source or derived format (for example, Portable Document Format or Hypertext Markup Language) must retain the above copyright notice, and the complete Datasheet User Manual documentation of this product including associated Application Notes; and a reference to other available product-related documentation.

### 10.3 Trademark Designations and Symbols

Trademark designations and symbols used in this documentation indicate that a product or feature is owned and registered as trademark and/or patent either by TRINAMIC or by other manufacturers, whose products are used or referred to in combination with TRINAMIC's products and TRINAMIC's product documentation.

This Hardware Manual is a non-commercial publication that seeks to provide concise scientific and technical user information to the target user. Thus, trademark designations and symbols are only entered in the Short Spec of this document that introduces the product at a quick glance. The trademark designation /symbol is also entered when the product or feature name occurs for the first time in the document. All trademarks and brand names used are property of their respective owners.

### 10.4 Target User

The documentation provided here, is for programmers and engineers only, who are equipped with the necessary skills and have been trained to work with this type of product.

The Target User knows how to responsibly make use of this product without causing harm to himself or others, and without causing damage to systems or devices, in which the user incorporates the product.

### 10.5 Disclaimer: Life Support Systems

TRINAMIC Motion Control GmbH & Co. KG does not authorize or warrant any of its products for use in life support systems, without the specific written consent of TRINAMIC Motion Control GmbH & Co. KG.

Life support systems are equipment intended to support or sustain life, and whose failure to perform, when properly used in accordance with instructions provided, can be reasonably expected to result in personal injury or death.

Information given in this document is believed to be accurate and reliable. However, no responsibility is assumed for the consequences of its use nor for any infringement of patents or other rights of third parties which may result from its use. Specifications are subject to change without notice.

### 10.6 Disclaimer: Intended Use

The data specified in this user manual is intended solely for the purpose of product description. No representations or warranties, either express or implied, of merchantability, fitness for a particular purpose



or of any other nature are made hereunder with respect to information/specification or the products to which information refers and no guarantee with respect to compliance to the intended use is given.

In particular, this also applies to the stated possible applications or areas of applications of the product. TRINAMIC products are not designed for and must not be used in connection with any applications where the failure of such products would reasonably be expected to result in significant personal injury or death (safety-Critical Applications) without TRINAMIC's specific written consent.

TRINAMIC products are not designed nor intended for use in military or aerospace applications or environments or in automotive applications unless specifically designated for such use by TRINAMIC. TRINAMIC conveys no patent, copyright, mask work right or other trade mark right to this product. TRINAMIC assumes no liability for any patent and/or other trade mark rights of a third party resulting from processing or handling of the product and/or any other use of the product.

## 10.7 Collateral Documents & Tools

This product documentation is related and/or associated with additional tool kits, firmware and other items, as provided on the product page at: [www.trinamic.com](http://www.trinamic.com).



## 11 Revision History

### 11.1 Hardware Revision

Version	Date	Author	Description
1.00	2019-FEB-28	TMC	First prototypes.
1.10	2019-APR-05	TMC	Release version.

Table 17: Hardware Revision

### 11.2 Document Revision

Version	Date	Author	Description
1.00	2019-DEC-05	OK	First release.
1.10	2019-DEC-16	GE	Updates and corrections.
1.20	2020-JAN-29	GE	Motor characteristics updated.
1.21	2020-APR-24	OK	New block diagram.

Table 18: Document Revision





## X-ON Electronics

Largest Supplier of Electrical and Electronic Components

*Click to view similar products for [Stepper Motors](#) category:*

*Click to view products by [Analog Devices](#) manufacturer:*

Other Similar products are found below :

[HT17-275](#) [5014-020](#) [HT17-271D](#) [82924041](#) [82924036](#) [82914016](#) [80910502](#) [80910501](#) [80910003](#) [HT23-598](#) [HT08-221](#) [902-0135-000](#)  
[MS11HS3P4067-09RL](#) [MS17HD6P4200-24RL](#) [MS11HS5P4150-13RL](#) [MS08HY1P4050-09RL](#) [MS08HY3P4050-02RL](#) [ML24HCAL3550-01RL](#) [MS17HD6P4100-16RL](#) [ML23HS8P4220-16RL](#) [MS17HD2P4200-20RL](#) [ML23HSAL4500-E](#) [MS14HS5P4100-03RL](#) [MS17HD2P4100-27RL](#) [MS14HS1P4100-09RL](#) [MS11HS1P4100-25RL](#) [ML23HSAP4300-18RL](#) [ML23HS4P4100-02RL](#) [PL23HS8L4550-05RL](#)  
[PL23HSAL4500-05RL](#) [MS17HD4P4150-22RL](#) [PM42S-048-HHC8](#) [PM20L-020-HHC3](#) [PM42L-048-HHC9](#) [82930002](#) [HT34-504](#) [82910003](#)  
[103H7823-0440](#) [103H7126-0440](#) [103H8223-5141](#) [103H8223-6340](#) [103H7126-0740](#) [103H7126-5740](#) [103H7822-5740](#) [STEPPER MOTOR BIPOLAR 42X38MM 2.8V 1.7A](#) [SY20STH30-0604A](#) [STEPPER MOTOR: UNIPOLAR/BIPOLAR 57Å—56MM](#) [ROB-10551](#) [STEPPER MOTOR: UNIPOLAR/BIPOLAR 57Å—76MM](#) [103H7123-5740](#)