

1. FEATURES

- 0V to 76V input common mode
- Low 8 μ V (typ) input offset voltage
- Low 0.1% (max) gain error
- Gain options
 - G = 10V/V (CSA230-10)
 - G = 20V/V (CSA230-20)
 - G = 50V/V (CSA230-50)
 - G = 100V/V (CSA230-100)
- SOT23-5 package

2. APPLICATIONS

- Base stations and communication equipment
- Power management systems
- Server backplanes
- Industrial control and automation
- Battery current sensing

3. DESCRIPTION

The CSA230 high-side current-sense amplifier has precision accuracy specifications of V_{OS} less than 8 μ V (typ) and gain error less than 0.1% (max).

The CSA230 features an input common-mode voltage range from 0V to 76V with 90kHz of small-signal bandwidth, which makes it ideal for interfacing with an ADC for multichannel multiplexed data acquisition systems.

The CSA230 operates over the -40°C to 125°C temperature range. See [Table 1](#) for the order information.

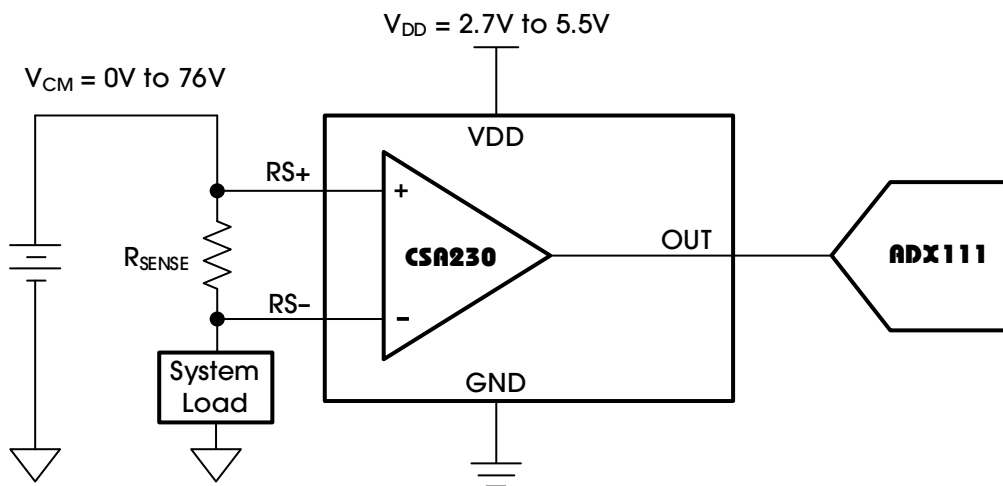

Table 1 lists the order information.

Table 1. Order Information

ORDER NUMBER ⁽¹⁾	PART NUMBER	CH (#)	PKG.	BIDIRECTIONAL	MARK	GAIN (TYP) (V/V)	GBW (kHz)	RATING	OP. TEMP (°C)	PKG. OPTION
CSA230LASOT235 ⁽²⁾	CSA230-10	1	SOT23-5	No	CSA230LA	10	90	Industry	-40-125	T/R-3000
CSA230MASOT235	CSA230-20	1	SOT23-5	No	CSA230MA	20	90	Industry	-40-125	T/R-3000
CSA230NASOT235	CSA230-50	1	SOT23-5	No	CSA230NA	50	90	Industry	-40-125	T/R-3000
CSA230PASOT235 ⁽²⁾	CSA230-100	1	SOT23-5	No	CSA230PA	100	90	Industry	-40-125	T/R-3000

Table 2. Family Selection Guide

ORDER NUMBER ⁽¹⁾	PART NUMBER	CH (#)	PKG.	BIDIRECTIONAL	MARK	GAIN (TYP) (V/V)	GBW (kHz)	RATING	OP. TEMP (°C)	PKG. OPTION
CSA220LASOT235 ⁽²⁾	CSA220-10	1	SOT23-5	No	CSA220LA	10	60	Industry	-40-125	T/R-3000
CSA220MASOT235 ⁽²⁾	CSA220-20	1	SOT23-5	No	CSA220MA	20	60	Industry	-40-125	T/R-3000
CSA220NASOT235	CSA220-50	1	SOT23-5	No	CSA220NA	50	60	Industry	-40-125	T/R-3000
CSA220PASOT235 ⁽²⁾	CSA220-100	1	SOT23-5	No	CSA220PA	100	60	Industry	-40-125	T/R-3000
CSA221LASOIC8 ⁽²⁾	CSA221-10	1	SOIC-8	Yes	CSA221LA	10	60	Industry	-40-125	T/R-4000
CSA221MASOIC8	CSA221-20	1	SOIC-8	Yes	CSA221MA	20	60	Industry	-40-125	T/R-4000
CSA221NASOIC8	CSA221-50	1	SOIC-8	Yes	CSA221NA	50	60	Industry	-40-125	T/R-4000
CSA221PASOIC8 ⁽²⁾	CSA221-100	1	SOIC-8	Yes	CSA221PA	100	60	Industry	-40-125	T/R-4000
CSA221LATSSOP8 ⁽²⁾	CSA221-10	1	TSSOP-8	Yes	CSA221LA	10	60	Industry	-40-125	T/R-4000
CSA221MATSSOP8	CSA221-20	1	TSSOP-8	Yes	CSA221MA	20	60	Industry	-40-125	T/R-4000
CSA221NATSSOP8	CSA221-50	1	TSSOP-8	Yes	CSA221NA	50	60	Industry	-40-125	T/R-4000
CSA221PATSSOP8 ⁽²⁾	CSA221-100	1	TSSOP-8	Yes	CSA221PA	100	60	Industry	-40-125	T/R-4000
CSA231LASOIC8 ⁽²⁾	CSA231-10	1	SOIC-8	Yes	CSA231LA	10	90	Industry	-40-125	T/R-4000
CSA231MASOIC8	CSA231-20	1	SOIC-8	Yes	CSA231MA	20	90	Industry	-40-125	T/R-4000
CSA231NASOIC8	CSA231-50	1	SOIC-8	Yes	CSA231NA	50	90	Industry	-40-125	T/R-4000
CSA231PASOIC8 ⁽²⁾	CSA231-100	1	SOIC-8	Yes	CSA231PA	100	90	Industry	-40-125	T/R-4000
CSA231LATSSOP8 ⁽²⁾	CSA231-10	1	TSSOP-8	Yes	CSA231LA	10	90	Industry	-40-125	T/R-4000
CSA231MATSSOP8	CSA231-20	1	TSSOP-8	Yes	CSA231MA	20	90	Industry	-40-125	T/R-4000
CSA231NATSSOP8	CSA231-50	1	TSSOP-8	Yes	CSA231NA	50	90	Industry	-40-125	T/R-4000
CSA231PATSSOP8 ⁽²⁾	CSA231-100	1	TSSOP-8	Yes	CSA231PA	100	90	Industry	-40-125	T/R-4000

Devices can be ordered via the following two ways:

1. Place orders directly on our website (www.analogsemi.com), or;
2. Contact our sales team by mailing to sales@analogsemi.com.

Note 1:

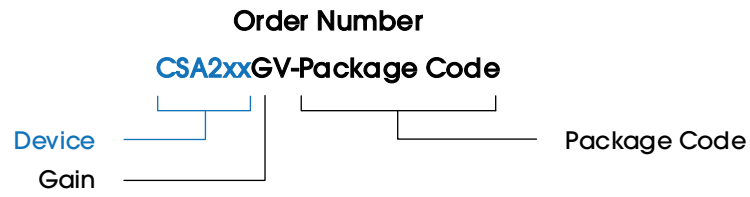

Note 2: Available in the future.

4. PIN CONFIGURATION AND FUNCTIONS

Figure 1 illustrates the pin configuration.

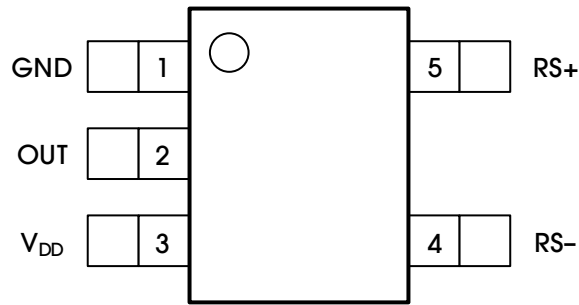

Figure 1. Pin Configuration

Table 3 lists the pin functions.

Table 3. Pin Functions

POSITION	NAME	TYPE	DESCRIPTION
1	GND	Power	Ground
2	OUT	Output	Output
3	V _{DD}	Power	Supply voltage, connecting at least 100nF capacitor to GND.
4	RS-	Input	External resistor load-side connection
5	RS+	Input	External resistor power-side connection

5. SPECIFICATIONS

5.1 ABSOLUTE MAXIMUM RATINGS

Table 4 lists the absolute maximum ratings of the CSA230.

Table 4. Absolute Maximum Ratings

PARAMETER	DESCRIPTION	MIN	MAX	UNITS
Voltage	V _{DD} to GND	-0.3	6.0	V
	RS+, RS- to GND	-0.3	80	
	REF1, REF2 to GND	-0.3	V _{DD} + 0,3	
	RS+ to RS-	1s maximum duration due to package thermal dissipation		
Current	Continuous input current (any pin)	-20	20	mA
Temperature	Operating, T _A	-40	125	°C
	Junction, T _J		150	
	Storage, T _{stg}	-65	150	
	Lead (soldering, 10s)		300	
	Soldering (reflow)		260	

Note: Stresses beyond those listed under Table 4 may cause permanent damage to the device. These are stress ratings only, which do not imply functional operation of the device at these or any other conditions beyond those indicated under Table 6. Exposure to absolute-maximum-rated conditions for extended periods may affect device reliability.

5.2 ESD RATINGS

Table 5 lists the ESD ratings of the CSA230.

Table 5. ESD Ratings

PARAMETER	SYMBOL	DESCRIPTION	VALUE	UNITS
Electrostatic Discharge	V _(ESD)	Human-body model (HBM), per ANSI/ESDA/JEDEC JS-001 ⁽¹⁾	±6000	V
		Charged-device model (CDM), per JEDEC specification JESD22-C101 ⁽²⁾	±1000	

Note 1: The JEDEC document JEP155 indicates that 500V HBM allows safe manufacturing with a standard ESD control process.

Note 2: The JEDEC document JEP157 indicates that 250V CDM allows safe manufacturing with a standard ESD control process.

5.3 RECOMMENDED OPERATING CONDITIONS

Table 6 lists the recommended operating conditions for the CSA230.

Table 6. Recommended Operating Conditions

PARAMETER	SYMBOL	MIN	NOM	MAX	UNITS
POWER SUPPLY					
Power Supply, V_{DD} to GND		2.7	3.3	5.5	V
ANALOG INPUTS					
Input Voltage Range, (RS+) - (RS-)	V_{IN}		V_{DD} / Gain		V
Absolute Input Voltage		GND		76	V
TEMPERATURE RANGE					
Operating Ambient Temperature	T_A	-40		125	°C

5.4 THERMAL INFORMATION

Table 7 lists the thermal information for the CSA230.

Table 7. Thermal Information

PARAMETER	SYMBOL	SOT23-5	UNITS
Junction-to-Ambient Thermal Resistance	$R_{\theta JA}$	168	°C/W
Junction-to-Board Thermal Resistance	$R_{\theta JB}$	39	°C/W
Junction-to-Case (Top) Thermal Resistance	$R_{\theta JC(top)}$	103	°C/W
Junction-to-Case (Bottom) Thermal Resistance	$R_{\theta JC(bot)}$	66	°C/W
Junction-to-Top Characterization Parameter	Ψ_{JT}	10	°C/W
Junction-to-Board Characterization Parameter	Ψ_{JB}	36	°C/W

5.5 ELECTRICAL CHARACTERISTICS

Table 8 lists the electrical characteristics of the CSA230. $V_{RS+} = V_{RS-} = 76V$, $V_{DD} = 3.3V$, $V_{SENSE} = V_{RS+} - V_{RS-} = 1mV$, $T_A = -40^{\circ}C$ to $125^{\circ}C$, unless otherwise noted. Typical values are at $T_A = 25^{\circ}C$ ⁽¹⁾.

Table 8. Electrical Characteristics

PARAMETER	SYMBOL	CONDITIONS	MIN	TYP	MAX	UNITS
DC CHARACTERISTICS						
Supply Voltage	V_{DD}	Guaranteed by PSRR	2.7		5.5	V
Supply Current	I_{DD}	$T_A = 25^{\circ}C$		560	800	μA
		$-40^{\circ}C < T_A < 125^{\circ}C$			850	
Power-Supply Rejection Ratio	PSRR	$2.7V \leq V_{DD} \leq 5.5V$	105	108		dB
Input Common-Mode Voltage Range	V_{CM}	Guaranteed by CMRR	0		76	V
Input Bias Current at V_{RS+} and V_{RS-} ⁽²⁾	I_{RS+}, I_{RS-}			0.003	0.1	μA
Input Offset Current ⁽²⁾	$I_{RS+} - I_{RS-}$				0.2	μA
Input Leakage Current ⁽²⁾	I_{RS+}, I_{RS-}	$V_{DD} = 0V, V_{RS+} = V_{RS-} = 76V$			0.2	μA
Common-Mode Rejection Ratio	CMRR	$0V < V_{RS+} < 76V$	130	159		dB
Input Offset Voltage ⁽³⁾	V_{OS}	$T_A = 25^{\circ}C$		± 8	± 60	μV
		$-40^{\circ}C \leq T_A \leq 125^{\circ}C$		± 50	± 150	
Input Offset Voltage Drift ⁽²⁾	TCV_{OS}			50		nV/ $^{\circ}C$
Input Sense Voltage	V_{SENSE}			V_{OH} / G		mV
Gain ⁽³⁾	G	CSA230-10		10		V/V
		CSA230-20		20		
		CSA230-50		50		
		CSA230-100		100		
Gain Error ⁽²⁾	GE	$T_A = 25^{\circ}C$		0.02	0.1	%
		$-40^{\circ}C \leq T_A \leq 85^{\circ}C$			0.25	
		$-40^{\circ}C \leq T_A \leq 125^{\circ}C$			0.3	
Output Low Voltage	V_{OL}	Sink 500 μA			10	mV
		No load			4	
Output High Voltage	V_{OH}	Source 500 μA	$V_{DD} - 0.01$			V
AC CHARACTERISTICS						
Signal Bandwidth	BW -3dB	All gain configurations $V_{SENSE} > 5mV$		90		kHz
Slew Rate	SR			0.5		V/ μs
AC Power-Supply Rejection Ratio	AC PSRR	$f = 200kHz$		47		dB
AC CMRR	AC CMRR	$f = 200kHz$		95		dB
Capacitive Load Stability	C_{LOAD}	With 250 Ω isolation resistor		20		nF
		Without any isolation resistor		500		pF
Input Voltage-Noise Density	e_n	$f = 1kHz$		58		nV/ \sqrt{Hz}
Power-Up Time ⁽⁴⁾				80		μs
Saturation Recovery Time				5		μs

Note 1: All devices are 100% production tested at $T_A = 25^{\circ}C$. All temperature limits are guaranteed by design.

Note 2: Specifications are guaranteed by design, not production tested.

Note 3: Gain and offset voltage are calculated based on two-point measurements: V_{SENSE1} and V_{SENSE2} .
 $V_{SENSE1} = 20\% \times \text{Full-Scale } V_{SENSE}$. $V_{SENSE2} = 80\% \times \text{Full-Scale } V_{SENSE}$.

Note 4: Output is high-Z during power-up.

5.6 TYPICAL CHARACTERISTICS

$V_{RS+} = V_{RS-} = 76V$, $V_{DD} = 3.3V$, $V_{SENSE} = V_{RS+} - V_{RS-} = 1mV$, $T_A = 25^{\circ}C$, unless otherwise noted.

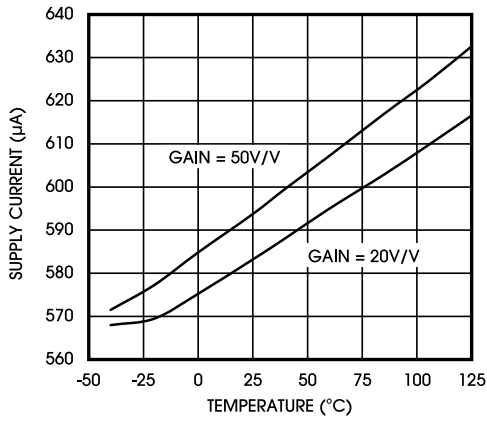

Figure 2. Supply Current vs. Temperature

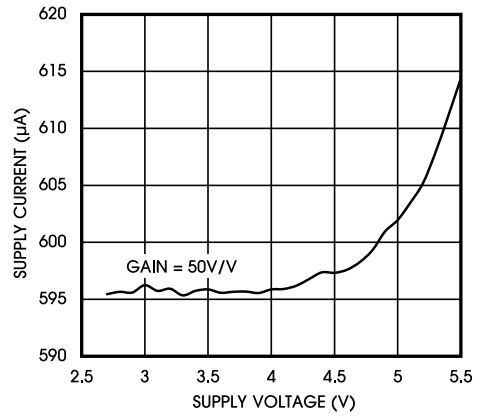

Figure 3. Supply Current vs. Supply Voltage

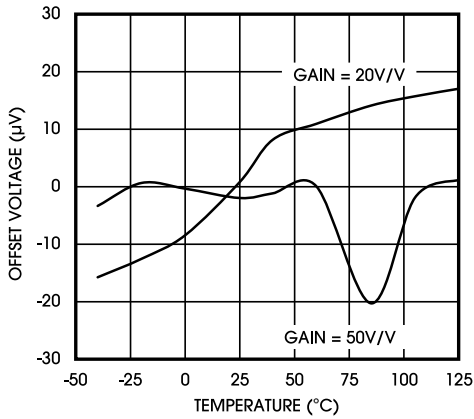

Figure 4. Input Offset Voltage vs. Temperature

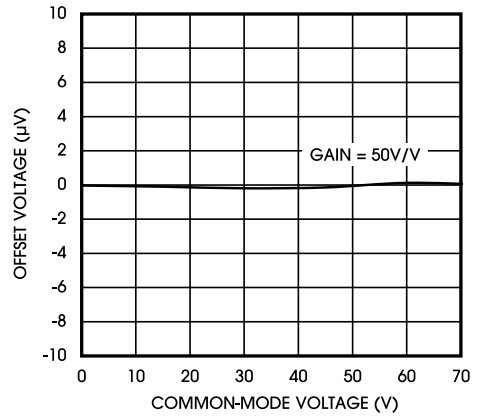

Figure 5. Input Offset Voltage vs. Input Common Mode Voltage

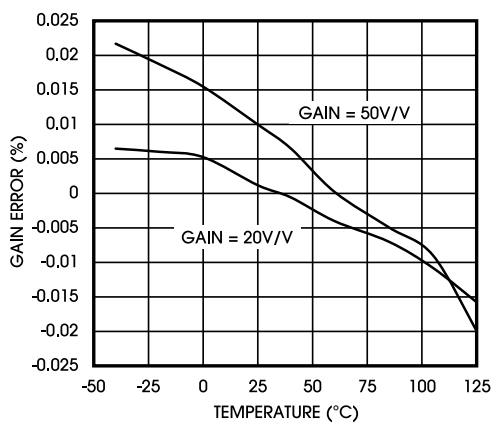

Figure 6. Gain Error vs. Temperature

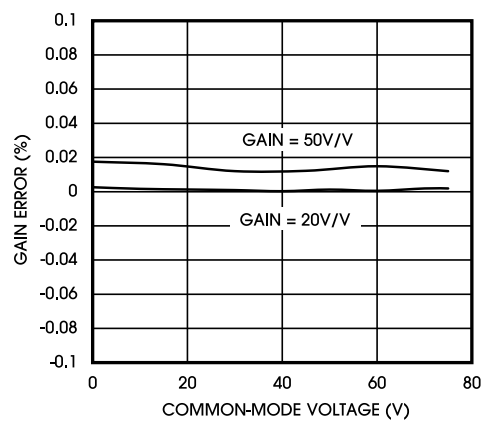

Figure 7. Gain Error vs. Common Mode Voltage

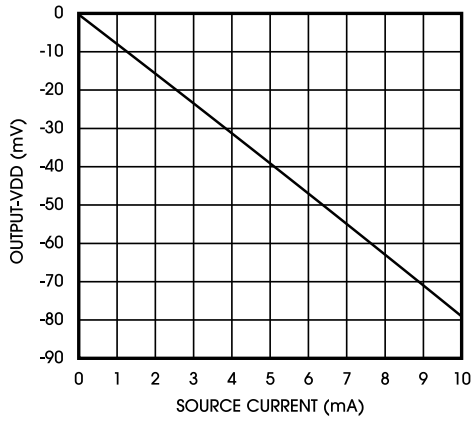

Figure 8. V_{OH} vs. Source Current

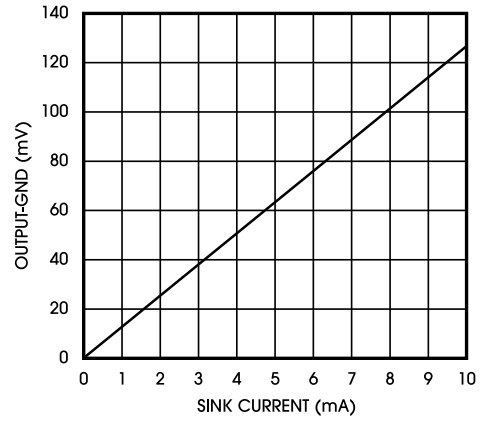

Figure 9. V_{OL} vs. Sink Current

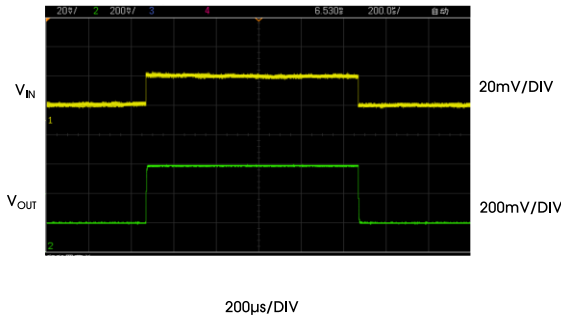

Figure 10. Small Signal Step Response

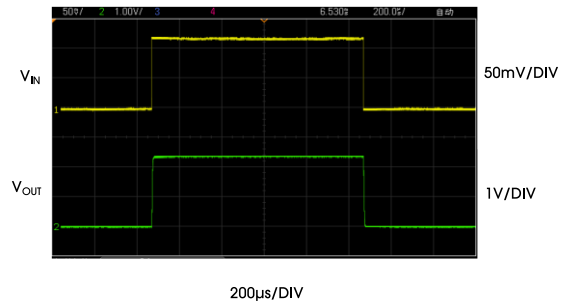

Figure 11. Large Signal Step Response

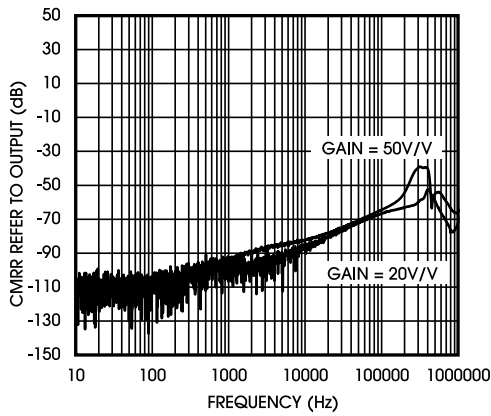

Figure 12. CMRR Referred to Output vs. Frequency

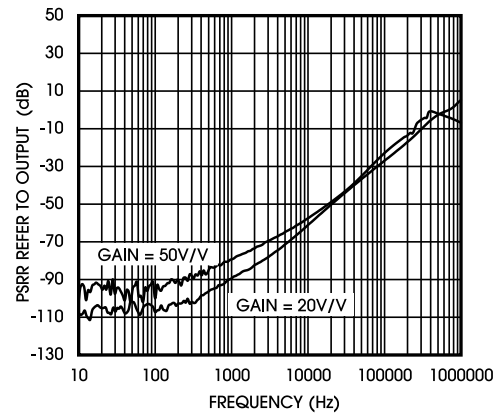

Figure 13. PSRR Referred to Output vs. Frequency

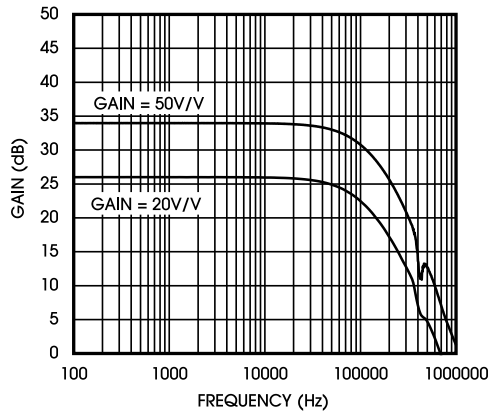

Figure 14. Gain vs. Frequency

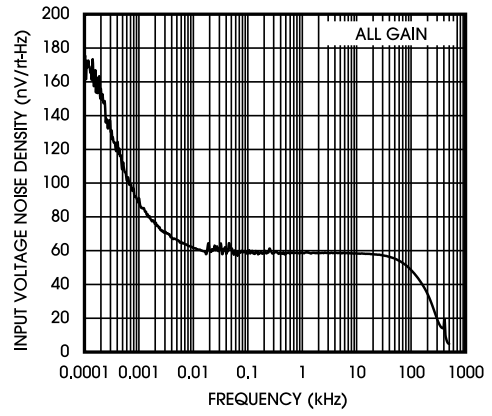

Figure 15. Input Voltage Noise Density vs. Frequency

6. DETAILED DESCRIPTION

6.1 OVERVIEW

The CSA230 high-side, current-sense amplifier features a 0V to 76V input common-mode range that is independent of supply voltage. This feature allows the monitoring of current out of a battery as low as 0V and enables high-side current sensing at voltages greater than the supply voltage (V_{DD}). The CSA230 monitors current through a current-sense resistor and amplifies the voltage across the resistor.

High-side current monitoring does not interfere with the ground path of the load being measured, making the CSA230 particularly useful in a wide range of high-voltage systems.

6.2 FUNCTIONAL BLOCK DIAGRAM

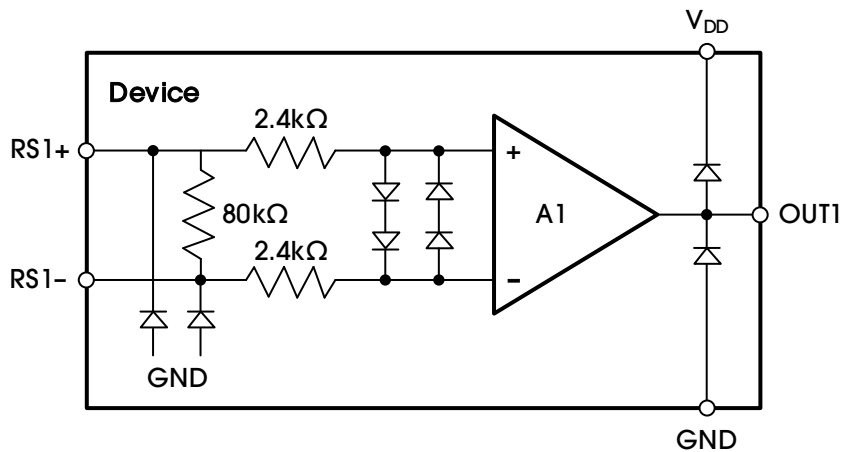

Figure 16. Functional Block Diagram

7. APPLICATION AND IMPLEMENTATION

NOTE

The information provided in this section is not part of the AnalogSemi component specification. Hence, AnalogSemi does not warrant its completeness or accuracy. Customers are responsible for determining suitability of components and system functionality for their applications. Validation and testing should be performed prior to design implementation.

7.1 APPLICATION INFORMATION

7.1.1 RECOMMENDED COMPONENT VALUES

Ideally, the maximum load current develops the full-scale sense voltage across the current-sense resistor. Power V_{DD} with typical 3.3V, and choose the gain needed to yield the maximum output voltage required for the application:

$$V_{OUT} = V_{SENSE} \times A_V \quad (1)$$

Where V_{SENSE} is the full-scale sense voltage, 330mV for gain of 10V/V, 165mV for gain of 20V/V, 66mV for gain of 50V/V, 33mV for gain of 100V/V, and A_V is the gain of the device.

In applications monitoring a high current, ensure that R_{SENSE} is able to dissipate its own I^2R loss. If the resistor's power dissipation exceeds the nominal value, its value may drift or it may fail altogether. The CSA230 senses a wide variety of currents with different sense-resistor values.

7.1.2 CHOOSING THE SENSE RESISTOR

Choose R_{SENSE} based on the following criteria:

- **Voltage Loss:** A high R_{SENSE} value causes the power-source voltage to degrade through IR loss. For minimal voltage loss, use the lowest R_{SENSE} value.
- **Accuracy:** A high R_{SENSE} value allows lower currents measured more accurately. This is due to offsets becoming less significant when the sense voltage is larger. For best performance, while using 3.3V for V_{DD} , select R_{SENSE} to provide approximately 330mV (gain of 10V/V), 165mV (gain of 20V/V), or 66mV (gain of 50V/V), 33mV (gain of 100V/V) of sense voltage for the full-scale current in each application.
- **Efficiency and Power Dissipation:** At high current levels, the I^2R losses in R_{SENSE} can be significant. Consider this when choosing the resistor value and its power dissipation (wattage) rating. In addition, the sense resistor's value might drift if it heats up excessively.
- **Inductance:** Keep inductance low if I_{SENSE} has a large high-frequency component. Wire-wound resistors have the highest inductance, while metal film is somewhat better. Low-inductance, metal-film resistors are also available. Instead of being spiral wrapped around a core, as in metal-film or wire wound resistors, they are a straight band of metal and are available in values under 1Ω.

Take care to eliminate parasitic trace resistance from causing errors in the sense voltage because of the high currents that flow through R_{SENSE} . Either use a four-terminal current-sense resistor or use Kelvin (force and sense) PCB layout techniques.

7.2 POWER-SUPPLY BYPASSING

Power-supply bypass capacitors are recommended for best performance and should be placed as close as possible to the supply and ground terminals of the device. A typical value for this supply bypass capacitor is 0.1μF (NP0/C0G type) close to the V_{DD}/GND pins. The capacitors should be rated for at least twice the maximum expected applied voltage. Applications with noisy or high-impedance power supplies may require additional decoupling capacitors to reject power-supply noise.

8. PACKAGE INFORMATION

The CSA230 is available in the SOT23-5 package. Figure 17 shows the package view.

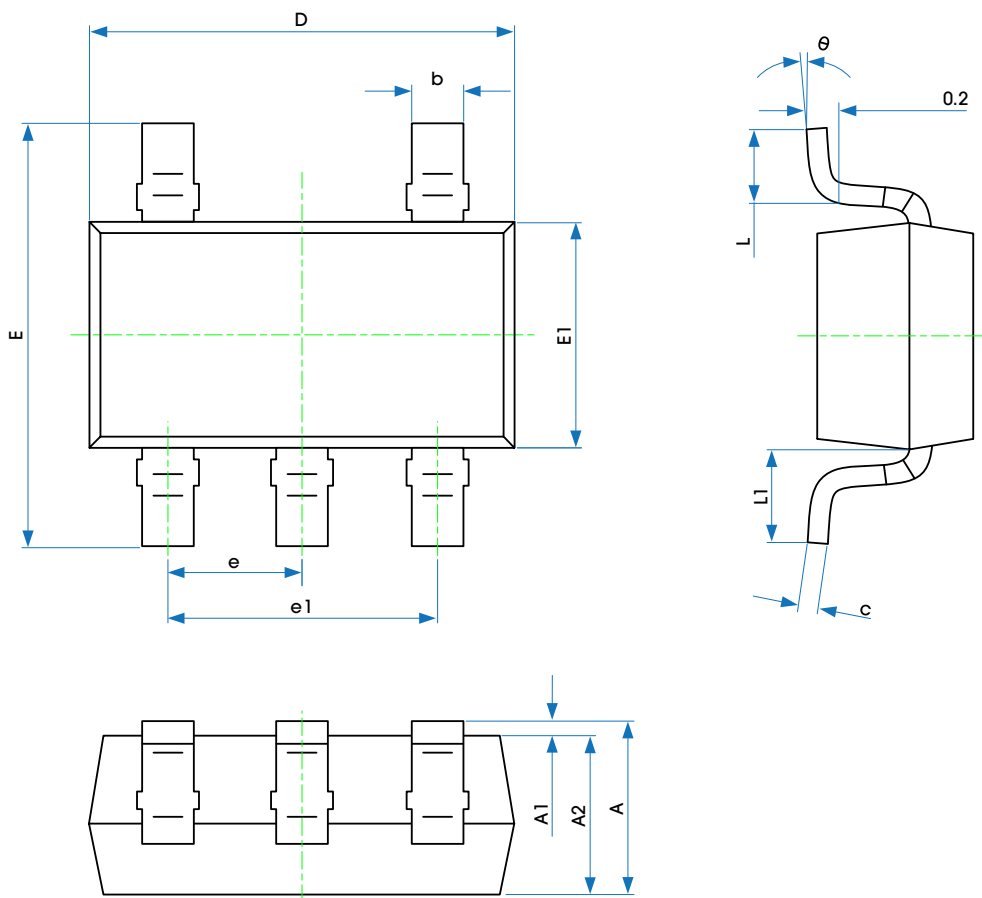

Figure 17. Package View

Table 9 provides detailed information about the dimensions of the package.

Table 9. Dimensions of the Package

SYMBOL	DIMENSIONS IN MILLIMETERS		DIMENSIONS IN INCHES	
	MIN	MAX	MIN	MAX
A	1.050	1.250	0.041	0.049
A1	0.000	0.100	0.000	0.004
A2	1.050	1.150	0.041	0.045
b	0.300	0.500	0.012	0.020
c	0.100	0.200	0.004	0.008
D	2.820	3.020	0.111	0.119
E	2.650	2.950	0.104	0.116
E1	1.500	1.700	0.059	0.067
e	0.950 (BSC)		0.037 (BSC)	
e1	1.800	2.000	0.071	0.079
L	0.300	0.600	0.012	0.024
L1	0.600 REF.		0.024 REF.	
θ	0°	8°	0°	8°

9. TAPE AND REEL INFORMATION

Figure 18 illustrates the carrier tape.

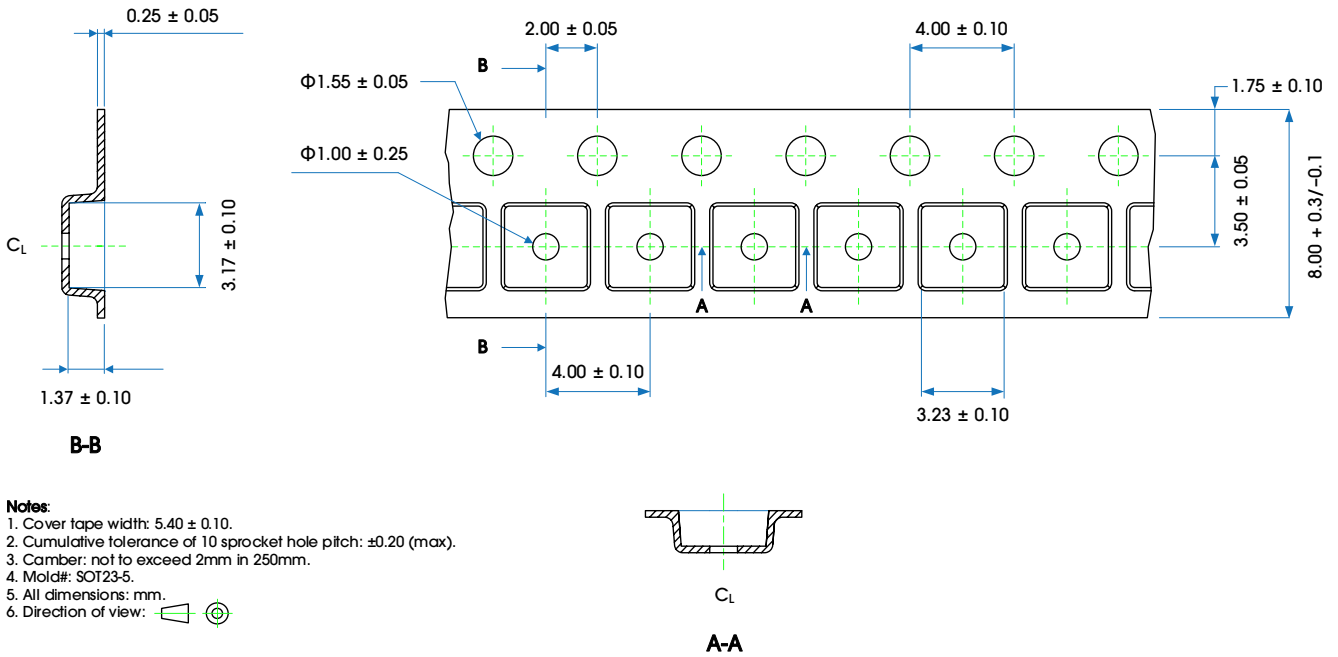

Figure 18. Carrier Tape Drawing

Table 10 provides information about tape and reel.

Table 10. Tape and Reel Information

PACKAGE TYPE	REEL	QTY/REEL	REEL/ INNER BOX	INNER BOX/ CARTON	QTY/CARTON	INNER BOX SIZE (MM)	CARTON SIZE (MM)
SOT23-5	7"	3000	1	20	60000	240*20*265	455*275*255

Figure 19 shows the product loading orientation—pin 1 is assigned at Q3.

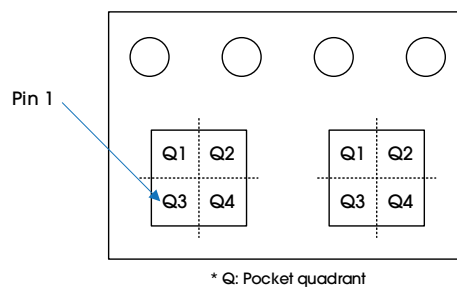

Figure 19. Product Loading Orientation

REVISION HISTORY

REVISION	DATE	DESCRIPTION
Rev A	22 November 2022	Rev A release.

X-ON Electronics

Largest Supplier of Electrical and Electronic Components

Click to view similar products for [Current Sense Amplifiers](#) category:

Click to view products by [analogsemi](#) manufacturer:

Other Similar products are found below :

[COSINA180A3](#) [LMP8278QMMX/NOPB](#) [LT6107HS5#TRPBF](#) [INA241A2IDDFR](#) [INA241A3IDDFR](#) [INA241A2QDDFRQ1](#)
[INA241A5IDDFR](#) [INA241B2QDDFRQ1](#) [INA281A3IDBVR](#) [INA296A3IDDFR](#) [INA241A1IDDFR](#) [WS74285C-8/TR](#) [INA296A2QDDFRQ1](#)
[INA241B2IDDFR](#) [INA211CIRSWR](#) [INA296A1QDDFRQ1](#) [INA296A3QDDFRQ1](#) [TSC200IDT](#) [CSA240LCTSSOP8](#) [CSA240LCSOIC8](#)
[CSA231NASOIC8](#) [CSD202CMSOP10](#) [CSA231LASOIC8](#) [CSA231NATSSOP8](#) [CSA240LQCSOIC8](#) [CSA220MASOT235](#)
[CSA2202MAMSOP8](#) [CSA231PASOIC8](#) [CSA230MASOT235](#) [CSA230NASOT235](#) [CSA221NASOIC8](#) [CSA231MASOIC8](#)
[CSA230PASOT235](#) [CSA220NASOT235](#) [CSA221MATSSOP8](#) [CSA231MATSSOP8](#) [CSA220LASOT235](#) [CSA2302MAMSOP8](#)
[CSA2202NAMSOP8](#) [CSA2302NAMSOP8](#) [CSA221NATSSOP8](#) [CSA2302LAMSOP8](#) [CSA221MASOIC8](#) [INA241A4IDDFR](#)
[INA241B3IDDFR](#) [INA310B2IDGKR](#) [INA212BIDCKR](#) [MAX9937AXK+T](#) [MAX4080FAUA+T](#) [MAX4073FAXK+T](#)