

CONDUIT SYSTEMS  
FOR ELECTRICAL  
WIRES AND CABLES

CATALOGUE 2019

**TO  
CONNECT  
AND  
PROTECT**





## CATALOGUE CONTENT

SUBJECT	ITEM	PAGE
<b>GENERAL</b>	Content page	0 1
	Conduit selection table	0 4
	Fitting selection table	0 7
	Company profile	0 13
<b>MULTIFLEX</b>	Conduit selection table	1 2
	FCEN conduit and fittings	1 3
	SL / SLI conduit and fittings	1 11
	SLI-CAP conduit and fittings	1 22
	SLB conduit and fittings	1 27
	UIG conduit and fittings	1 29
	UI conduit and fittings	1 30
	UI-CAP conduit and fittings	1 42
	RWS conduit and fittings	1 47
	RWA conduit and fittings	1 48
	ANAFLEX conduit and fittings	1 51
<b>MULTITITE</b>	Conduit selection table	2 2
	FCD black conduit	2 3
	FCD grey conduit	2 4
	FCE black conduit	2 5
	FCE-LFH black conduit	2 6
	FCE-PU-VO black conduit	2 7
	Fittings IP 54 for FCD / FCE	2 8
	Fittings IP 65 for FCD / FCE	2 11
	Fittings IP 68 for FCD / FCE	2 16
	FCE-LFHB conduit and fittings	2 20



<b>SEALTITE</b>	Conduit selection table	3   2
	EF-M grey / black conduit	3   3
	EF grey / black conduit	3   5
	OR black / blue conduit	3   7
	HC black conduit	3   9
	HCX black conduit	3   10
	HFX black / blue conduit	3   11
	HFX-VO black conduit	3   13
	ZHLS black conduit	3   14
	HTDL black conduit	3   15
	HTUA grey conduit	3   16
	ZHUA black conduit	3   17
	CW blue conduit	3   18

<b>SEALTITE SPECIAL</b>	Conduit selection table	4   2
	HCI black / blue conduit	4   3
	HFI black / blue conduit	4   5
	HCXI black conduit	4   7
	HCI-316 black conduit	4   8
	HFI-316 black / blue conduit	4   9
	EF-L grey conduit	4   11
	AS black conduit	4   12
	Shieldtite grey conduit	4   13
	Shieldtite Z1 grey conduit	4   14
	FG white/blue conduit	4   15
	HTFG white / blue conduit	4   17
	HTFGI-316 blue conduit	4   19
	XTHF grey conduit	4   20

<b>SEALTITE FITTINGS</b>	Fitting selection table	5   2
	Nickel plated brass fittings	5   3
	Stainless steel AISI-304 fittings	5   20
	Stainless steel AISI-316 fittings	5   28
	Food grade fittings	5   35
	Aluminum fittings	5   38
	Zinc diecast fittings	5   39
	Galvanised steel fittings	5   40

















<b>SPECIAL FITTINGS</b>	Fitting selection table	6   2
	Powerconnector adapters	6   3
	Sensor adapters	6   6
	Accessories nickel plated brass	6   10
	Accessories stainless steel	6   19
	Conduit pipe connector	6   25
	Cable glands	6   26



<b>ATEX FITTINGS</b>	Conduit / fitting selection table	7 2	
	Engineering data	7 3	
	Sealtite conduits	7 7	
	BXA ATEX barrier fittings	7 12	
	RNA / RAA ATEX cable-hose fittings	7 14	
	BNA / BAA ATEX barrier fittings	7 24	
	BXC ATEX swivel barrier fittings	7 34	
	RNC / RAC ATEX adapter fitting	7 38	
	BNC / BAC barrier adapter fittings	7 48	
	BXN ATEX cable gland	7 56	
	RN/RAD ATEX cable gland	7 58	
	ATEX accessories	7 66	
	<b>ALL-PLASTIC</b>	Conduit selection table	8 2
		CNP orange / grey conduit and fittings	8 3
NMUA grey conduit		8 7	
NMSF grey conduit and fittings		8 8	
NMFG blue conduit and fittings		8 13	
MPC grey conduit		8 20	
MPU blue conduit and fittings		8 21	
<b>ANA-QUICK</b>		Conduit selection table	9 2
	PA6L black conduit	9 3	
	PA6S black / grey conduit	9 4	
	PA6SU black conduit	9 6	
	PA6V0 black conduit	9 7	
	PA12S black conduit	9 8	
	PP MOD black conduit	9 9	
	PA6 DUO / PP MOD DUO / PP UV DUO		
	Black conduit	9 10	
	Fittings for Ana-quick	9 13	
	Gigant PA6 / PP / PUR conduit and fittings	9 26	
	<b>HEATPROTECTION</b>	Product selection table	10 2
		Engineering data	10 3
Hiprojacket Aero		10 4	
Hiprojacket Industrial		10 6	
Fittings for Hiprojacket		10 8	
Hiprojacket Light		10 10	
Hiprosiltape red/black		10 11	
Hiprotape		10 12	
Hiproblanket Wrap		10 14	
Thermojacket S and fittings		10 18	
Silicajacket		10 22	
Basaltjacket		10 23	
Hiproblanket		10 24	
Silicablanket		10 29	
<b>GENERAL</b>		Conduit installation manual	11 2
	Fittings installation manual	11 3	
	Chemical resistance	11 6	
	Part number / page information	11 10	
	Anamet worldwide addresses	11 24	



























# Conduit selection table

METAL CONDUIT	MATERIAL	MATERIAL	TEMPERATURE		RESISTANCE (NEN-EN-IEC 61386)			FLEXI-BILITY	RESISTANCE		APPROVALS	PROTEC-TION	PAGE
			Min.	Max.	Compr.	Impact	Tensile		UV	Oil			
Type	Core	Cover									Class		
<b>FCEN</b>	Galvanised steel	-	-55 °C	+300 °C	4 (1250N)	4 (6J)	4 (1000N)	++++	++++	++++		IP 40	1 - 3
<b>SL</b>	Galvanised steel	-	-55 °C	+300 °C	4 (1250N)	4 (6J)	4 (1000N)	+++	++++	++++		IP 40	1 - 11
<b>SLI</b>	Stainless steel AISI-304	-	-100 °C	+600 °C	4 (1250N)	4 (6J)	4 (1000N)	+++	++++	++++		IP 40	1 - 12
<b>SLI-316</b>	Stainless steel AISI-316	-	-100 °C	+600 °C	4 (1250N)	4 (6J)	4 (1000N)	+++	++++	++++		IP 40	1 - 19
<b>SLI-CAP</b>	Stainless steel AISI-304	-	-100 °C	+600 °C	3 (750N)	3 (2J)	3 (500N)	++++	++++	++++		IP 40	1 - 22
<b>SLB</b>	Galvanised steel with stainless-steel braid	-	-55 °C	+300 °C	4 (1250N)	4 (6J)	4 (1000N)	++++	++++	++++		IP 40	1 - 27
<b>UIG</b>	Galvanised steel	-	-55 °C	+300 °C	5 (4000N)	4 (6J)	4 (1000N)	++++	++++	++++		IP 40	1 - 29
<b>UI</b>	Stainless steel AISI-304	-	-100 °C	+600 °C	5 (4000N)	4 (6J)	4 (1000N)	++++	++++	++++		IP 40	1 - 30
<b>UI-CAP</b>	Stainless steel AISI-304	-	-100 °C	+600 °C	5 (4000N)	4 (6J)	4 (1000N)	++++	++++	++++		IP 40	1 - 42
<b>RWS</b>	Galvanised steel	-	-45 °C	+230 °C	4 (1250N)	4 (6J)	3 (500N)	++	++++	++++		IP 40	1 - 47
<b>RWA</b>	Aluminium	-	-45 °C	+260 °C	4 (1250N)	4 (6J)	3 (500N)	++	++++	++++		IP 40	1 - 48
<b>Anaflex</b>	Stainless steel AISI-316L	-	-70 °C	+250 °C	3 (750N)	3 (2J)	4 (1000N)	++++	++++	++++		IP 69	1 - 51
<b>FCD Black</b>	Galvanised steel	PVC RoHS	-20 °C	+80 °C	3 (750N)	3 (2J)	3 (500N)	++++	++++	++		IP 67	2 - 3
<b>FCD Grey</b>	Galvanised steel	PVC RoHS	-20 °C	+80 °C	3 (750N)	3 (2J)	3 (500N)	++++	++	++		IP 67	2 - 4
<b>FCE Black</b>	Galvanised steel	PVC RoHS	-20 °C	+80 °C	4 (1250N)	4 (6J)	4 (1000N)	++++	++++	++		IP 67	2 - 5
<b>FCE-LFH Black</b>	Galvanised steel	TPO Halogen free RoHS	-25 °C	+80 °C	4 (1250N)	4 (6J)	4 (1000N)	++++	++++	++		IP 67	2 - 6



















# Conduit selection table

## Anaconda Sealtite®



























































SEALTITE	MATERIAL	MATERIAL	TEMPERATURE		RESISTANCE (NEN-EN-IEC 61386)			FLEXI- BILITY	RESISTANCE		APPROVALS	PROTEC- TION	PAGE
			Core	Cover	Min.	Max.	Compr.		Impact	Tensile			
<b>EF-M Grey Black</b>	Galvanised steel	PVC RoHS	-20 °C	+70 °C	3 (750N)	4 (6J)	4 (1000N)	++	+++	+++		IP 66 IP 67	3 - 3 3 - 4
<b>EF Grey Black</b>	Galvanised steel	PVC RoHS	-25 °C	+70 °C	4 (1250N)	4 (6J)	4 (1000N)	+++	+++	+++		IP 66 IP 67	3 - 5 3 - 6
<b>OR Black</b>	Galvanised steel	PVC RoHS	-15 °C	+100 °C	4 (1250N)	4 (6J)	4 (1000N)	+++	++++	++++		IP 66 IP 67	3 - 7
<b>OR Blue</b>	Galvanised steel	PVC RoHS	-15 °C	+100 °C	4 (1250N)	4 (6J)	4 (1000N)	+++	++++	++++		IP 66 IP 67	3 - 8
<b>HC Black</b>	Galvanised steel	PVC RoHS	-45 °C	+105 °C	4 (1250N)	4 (6J)	4 (1000N)	+++	++++	++++		IP 66 IP 67	3 - 9
<b>HGX Black</b>	Galvanised steel	TPE RoHS	-55 °C	+145 °C	4 (1250N)	4 (6J)	4 (1000N)	++++	+++	++		IP 66 IP 67	3 - 10
<b>HFX Black</b>	Galvanised steel	TPU Halogen free RoHS	-55 °C	+105 °C	4 (1250N)	4 (6J)	4 (1000N)	++++	++++	++++		IP 66 IP 67	3 - 11
<b>HFX Blue</b>	Galvanised steel	TPU Halogen free RoHS	-55 °C	+105 °C	4 (1250N)	4 (6J)	4 (1000N)	++++	++++	++++		IP 66 IP 67	3 - 12
<b>HFX-VO Black</b>	Galvanised steel	TPU Halogen free RoHS	-50 °C	+105 °C	4 (1250N)	4 (6J)	4 (1000N)	++++	++++	++++	 	IP 66 IP 67	3 - 13
<b>ZHLS Black</b>	Galvanised steel	TPO Halogen free RoHS	-25 °C	+80 °C	4 (1250N)	4 (6J)	4 (1000N)	+++	++++	++	  	IP 66 IP 67	3 - 14
<b>HTDL Black</b>	Galvanised steel	PVC RoHS	-45 °C	+105 °C	4 (1250N)	4 (6J)	4 (1000N)	+++	++++	++++	  	IP 66 IP 67	3 - 15
<b>HTUA Grey</b>	Galvanised steel	PVC RoHS	-45 °C	+105 °C	4 (1250N)	4 (6J)	4 (1000N)	+++	++++	++++	  	IP 66 IP 67	3 - 16
<b>ZHUA Black</b>	Galvanised steel	TPU Halogen free RoHS	-50 °C	+105 °C	4 (1250N)	4 (6J)	4 (1000N)	++++	++++	++++	  	IP 66 IP 67	3 - 17
<b>CW Blue</b>	Galvanised steel	PVC RoHS	-40 °C	+80 °C	4 (1250N)	4 (6J)	4 (1000N)	+++	++++	++++	  	IP 66 IP 67	3 - 18













## CONDUIT SELECTION TABLE

METAL CONDUIT	MATERIAL	MATERIAL	TEMPERATURE		RESISTANCE (NEN-EN-IEC 61386)			FLEXI-BILITY	RESISTANCE		APPROVALS	PROTEC-TION	PAGE
			Min.	Max.	Compr.	Impact	Tensile		UV	Oil			
Type	Core	Cover									Class		
<b>HCI Black/Blue</b>	Stainless steel AISI-304	PVC RoHS	-45 °C	+105 °C	4 1250N	4 (6J)	4 1000N	+++	++++	++++		IP 66	4 - 3
												IP 67	4 - 4
<b>HFI Black</b>	Stainless steel AISI-304	TPU Halogen free RoHS	-55 °C	+105 °C	4 1250N	4 (6J)	4 1000N	++++	++++	++++		IP 66	4 - 5
												IP 67	
<b>HFI Blue</b>	Stainless steel AISI-304	TPU Halogen free RoHS	-55 °C	+105 °C	4 1250N	4 (6J)	4 1000N	++++	++++	++++		IP 66	4 - 6
												IP 67	
<b>HCXI Black</b>	Stainless steel AISI-304	TPE RoHS	-55 °C	+145 °C	4 1250N	4 (6J)	4 1000N	++++	+++	++		IP 66	4 - 7
												IP 67	
<b>HCI-316 Black</b>	Stainless steel AISI-304	PVC RoHS	-45 °C	+105 °C	4 1250N	4 (6J)	4 1000N	+++	++++	++++		IP 66	4 - 8
												IP 67	
<b>HFI-316 Black/Blue</b>	Stainless steel AISI-316	TPU Halogen free RoHS	-55 °C	+105 °C	4 1250N	4 (6J)	4 1000N	++++	++++	++++		IP 66	4 - 9
												IP 67	
<b>EF-L Grey</b>	Aluminum	PVC RoHS	-20 °C	+80 °C	3 750N	3 (2J)	3 500N	+++	+++	+++		IP 66	4 - 11
												IP 67	
<b>AS Black</b>	Galvanised steel	PVC RoHS	-25 °C	+70 °C	4 1250N	4 (6J)	4 1000N	+++	++++	+++		IP 66	4 - 12
												IP 67	
<b>Shield-tite Grey</b>	Bronze	PVC RoHS	-45 °C	+105 °C	4 1250N	4 (6J)	4 1000N	+++	++++	++++		IP 66	4 - 13
												IP 67	
<b>Shield-tite Z1</b>	Bronze	TPU Halogen free RoHS	-50 °C	+105 °C	4 1250N	4 (6J)	4 1000N	+++	++++	++++	 	IP 66	4 - 14
												IP 67	
<b>FG White/Blue</b>	Galvanised steel	PVC RoHS	-20 °C	+60 °C	4 1250N	4 (6J)	4 1000N	+++	++	+++	 	IP 66	4 - 15
												IP 67	
<b>HTFG White</b>	Galvanised steel	TPU Halogen free RoHS	-55 °C	+105 °C	4 1250N	4 (6J)	4 1000N	++++	++++	++++		IP 66	4 - 17
												IP 67	
<b>HTFG Blue</b>	Galvanised steel	TPU Halogen free RoHS	-55 °C	+105 °C	4 1250N	4 (6J)	4 1000N	++++	++++	++++		IP 66	4 - 18
												IP 67	
<b>HTFGI -316 Blue</b>	Stainless steel AISI-316	TPU Halogen free RoHS	-55 °C	+105 °C	4 1250N	4 (6J)	4 1000N	++++	++++	++++		IP 66	4 - 19
												IP 67	
<b>XTHF Grey</b>	Galvanised steel	Silicone Halogen free RoHS	-70 °C	+ 2 0 0 °C	4 1250N	4 (6J)	4 1000N	+++	+++	++++		IP 66	4 - 20
												IP 67	

# Fittings selection table

FITTING	MATERIAL	TEMPERATURE		THREAD SIZE RANGE			SHIELDING	APPROVALS	PROTECTION	PAGE
		Min.	Max.	ISO	Pg	NPT				
<b>Straight compact</b>	Nickel plated brass	-45 °C	+105 °C	M16 to M90	Pg 11 to Pg 48	1/2" to 3"	++++	   	IP 66 IP 67	5 - 3 till 5 - 9
<b>45° compact</b>	Nickel plated brass	-45 °C	+105 °C	M16 to M75	-	1/2" to 3"	+++	   	IP 66 IP 67	5 - 3 till 5 - 9
<b>90° compact</b>	Nickel plated brass	-45 °C	+105 °C	M16 to M75	Pg 11 to Pg 48	1/2" to 3"	+++	   	IP 66 IP 67	5 - 3 till 5 - 9
<b>Cable-hose</b>	Nickel plated brass	-45 °C	+105 °C	M16 to M40	-	-	+++	 	IP 67 IP 68	5 - 4
<b>Str / 45° / 90° Swivel</b>	Nickel plated brass	-45 °C	+105 °C	M16 to M63	-	1/2" to 1"	+++	 	IP 67	5 - 10 till 5 - 11
<b>Straight</b>	Nickel plated brass	-45 °C	+105 °C	M12 to M63	Pg 7 to Pg 48	1/2" to 2"	+++	   	IP 67	5 - 12 till 5 - 19
<b>45°</b>	Nickel plated brass	-45 °C	+105 °C	M16 to M63	Pg 11 to Pg 48	1/2" to 2"	+++	   	IP 67	5 - 12 till 5 - 19
<b>90°</b>	Nickel plated brass	-45 °C	+105 °C	M16 to M63	Pg 11 to Pg 48	1/2" to 2"	+++	   	IP 67	5 - 12 till 5 - 19
<b>Female</b>	Nickel plated brass	-45 °C	+105 °C	M16 to M63	Pg 11 to Pg 48	1/2" to 2"	+++	   	IP 67	5 - 12 till 5 - 19
<b>Cable-hose (EMC)</b>	Nickel plated brass	-40 °C	+100 °C	M16 to M63	Pg 9 to Pg 29	1/2" to 3/4"	+++	 	IP 67 IP 68	5 - 12 till 5 - 19
<b>Str / 45° / 90° Compact</b>	Stainless steel AISI-304	-45 °C	+105 °C	M16 to M63	-	1/2" to 3"	+++	   	IP 66 IP 67	5 - 20 till 5 - 23
<b>Straight / 45° / 90°</b>	Stainless steel AISI-304	-45 °C	+105 °C	M16 to M50	Pg 11 to Pg 48	1/2" to 1"	+++	   	IP 67	5 - 24 till 5 - 27
<b>Str / 45° / 90° Compact</b>	Stainless steel AISI-316	-45 °C	+105 °C	M16 to M63	-	1/2" to 3"	+++	   	IP 66 IP 67	5 - 28 till 5 - 34
<b>Food Compact</b>	Stainless steel AISI-316	-45 °C	+105 °C	M16 to M63	-	-	+++	 	IP 68 IP 69	5 - 35 till 5 - 37
<b>Straight / 90°</b>	Aluminium	-55 °C	+300 °C	-	-	1/2" to 2"	+++	   	IP 67	5 - 38
<b>Straight / 45° / 90°</b>	Galvanised steel	-55 °C	+300 °C	M16 to M32	Pg 11 to Pg 48	1/2" to 4"	+++	   	IP 67	5 - 39 till 5 - 44
<b>Hummel adapter</b>	Nickel plated brass	-45 °C	+105 °C	M25 x 1 M42 x 1	Pg 11	-	+++	 	IP 67	6 - 3 till 6 - 4

## FITTING SELECTION TABLE





FITTING Type	MATERIAL Housing	TEMPERATURE		THREAD SIZE RANGE			SHIELDING	APPROVALS	PROTECTION	PAGE
		Min.	Max.	ISO	Pg	NPT	EMP		Class	
<b>Other makes</b>	Nickel plated brass	-45 °C	+105 °C	M24 x 1	-	-	+++		IP 67	6 - 5
<b>Sensor adapter</b>	Nickel plated brass	-45 °C	+105 °C	M8 x 1 M12 x 1 M18 x 1 M30 x 1,5	-	-	+++		IP 65	6 - 6
<b>Sensor adapter</b>	Nickel plated brass / poly-carbonate	-45 °C	+105 °C	M8 x 1 M12 x 1 M18 x 1	-	-	-		IP 65	6 - 7 till 6 - 8
<b>Sensor adapter</b>	Polyamide PA6	-45 °C	+105 °C	M8 x 1 M12 x 1 M18 x 1 M30 x 1,5	-	-	-		IP 65	6 - 9
<b>Accessories</b>	Accessories for nickel plated brass fittings	-55 °C	+105 °C	-	-	-	-		-	6 - 10 till 6 - 18
<b>Accessories</b>	Accessories for stainless steel AISI-304 fittings	-55 °C	+105 °C	-	-	-	-		-	6 - 19 till 6 - 20
<b>Accessories</b>	Accessories for stainless steel AISI-316 fittings	-55 °C	+105 °C	-	-	-	-		-	6 - 21
<b>Accessories</b>	Accessories for galvanised steel fittings	-55 °C	+300 °C	-	-	-	-		-	6 - 22 till 6 - 24
<b>Pipe fittings</b>	Nickel plated brass fittings	-45 °C	+105 °C	DN16 to DN32	-	-	+++		IP 67	6 - 25
<b>Cable glands</b>	Nickel plated brass	-55 °C	+125 °C	M16 to M50	-	-	+++		IP 68	6 - 26
<b>Cable glands</b>	Nickel plated brass or stainless steel AISI-316	-45 °C	+105 °C	M16 to M50	-	1/2" to 1.1/2"	+++		IP 68	6 - 27 till 6 - 30



# Plastic conduit selection table

ALL-PLASTIC	MATERIAL	MATERIAL	TEMP. (°C)		RESISTANCE (NEN-EN-IEC 61386)			FLEXI-BILITY	RESISTANCE		APPROVALS	PROTECTION	PAGE
			Min.	Max.	Compr.	Impact	Tensile		UV	Oil			
Type	Innercore	Cover										Class	
<b>CNP Orange</b>	PVC, Nylon reinforced RoHS	PVC RoHS	-20 °C	+60 °C	1 (125N)	3 (2J)	4 (1000N)	++	++++	++++	UL, GOST-R, SF	IP 66 IP 67	8 - 3
<b>CNP Grey</b>	PVC, Nylon reinforced RoHS	PVC RoHS	-20 °C	+60 °C	1 (125N)	3 (2J)	4 (1000N)	++	++++	++++	UL, GOST-R, SF	IP 66 IP 67	8 - 4
<b>NMUA Grey</b>	PVC, PVC reinforced RoHS	-	-20 °C	+80 °C	2 (320N)	3 (2J)	4 (1000N)	+++	++++	+++	UL, GOST-R, SF	IP 66 IP 67	8 - 7
<b>NMSF Grey</b>	PVC, PVC reinforced RoHS	-	-20 °C	+80 °C	1 (125N)	3 (2J)	4 (1000N)	++++	+++	+++	GOST-R	IP 66 IP 67	8 - 8
<b>NMFG Blue</b>	PVC, PVC reinforced RoHS	-	-35 °C	+60 °C	1 (125N)	3 (2J)	4 (1000N)	++++	+++	+++	GOST-R, NSF	IP 66 IP 67	8 - 13
<b>MPC Grey</b>	Metal spiral	PVC RoHS	-20 °C	+70 °C	3 (750N)	3 (2J)	1 (100N)	++++	+++	++	RoHS	IP 66 IP 67	8 - 20
<b>MPU Blue</b>	Metal spiral	TPU Halogen free RoHS	-40 °C	+90 °C	3 (750N)	3 (2J)	1 (100N)	++++	+++	++++	RoHS	IP 66 IP 67	8 - 21
<b>PAGL Black</b>	Polyamide PA6 Halogen free	-	-40 °C	+120 °C	1 (125N)	1 (0,5J)	1 (100N)	++++	++++	++++	UL-94 HB, RoHS	IP 67	9 - 3
<b>PAGS Black</b>	Polyamide PA6 Halogen free	-	-40 °C	+120 °C	2 (320N)	2 (1J)	2 (250N)	++++	++++	++++	UL-94 HB, RoHS	IP 67	9 - 4
<b>PAGS Grey</b>	Polyamide PA6 Halogen free	-	-40 °C	+120 °C	2 (320N)	2 (1J)	2 (250N)	++++	+++	++++	UL-94 HB, RoHS	IP 67	9 - 5
<b>PAGSU Black</b>	Polyamide PA6 Halogen free	-	-40 °C	+120 °C	2 (320N)	2 (1J)	2 (250N)	++++	++++	++++	UL-94 HB, RoHS	IP 67	9 - 6
<b>PAGVO Black</b>	Polyamide PA6 Halogen free	-	-40 °C	+120 °C	3 (750N)	3 (2J)	3 (500N)	++++	++++	++++	UL-94 V0, EN 45549-2, RoHS, CE, US	IP 67	9 - 7
<b>PA12S Black</b>	Polyamide PA12 Halogen free	-	-40 °C	+120 °C	2 (320N)	2 (1J)	2 (250N)	++++	++++	++++	UL-94 HB, RoHS	IP 67	9 - 8
<b>PP-Mod Black</b>	Polypropylene PP-Mod	-	-40 °C	+135 °C	1 (125N)	1 (0,5J)	1 (100N)	++++	++++	++++	UL-94 V2, RoHS	IP 67	9 - 9
<b>PAGS DUO</b>	Polyamide PA6 Halogen free	-	-40 °C	+120 °C	3 (750N)	3 (2J)	3 (500N)	++++	++++	++++	UL-94 HB, RoHS	IP 54	9 - 10
<b>PP-Mod DUO</b>	Polypropylene PP-Mod	-	-40 °C	+135 °C	2 (320N)	2 (1J)	2 (250N)	++++	++	++++	UL-94 V2, RoHS	IP 54	9 - 11

## PLASTIC CONDUIT SELECTION TABLE

ALL-PLASTIC	MATERIAL	MATERIAL	TEMPERATURE		RESISTANCE (NEN-EN-IEC 61386)			FLEXIBILITY	RESISTANCE		APPROVALS	PROTECTION	PAGE
			Innercore	Cover	Min.	Max.	Compr.		Impact	Tensile			
<b>PP-UV DUO</b>	Polypropylene PP-Mod	-	-40 °C	+135 °C	2 (320N)	2 (1J)	2 (250N)	++++	++++	++++	UL-94 V2 	IP 54	9 - 12
<b>GIG PA6 Black</b>	Polyamide PA6 Halogen free	-	-40 °C	+120 °C	2 (320N)	2 (1J)	2 (250N)	+++	++++	++++	UL-94 HB 	IP 67	9 - 26
<b>GIG PA6 Grey</b>	Polyamide PA6 Halogen free	-	-40 °C	+120 °C	2 (320N)	2 (1J)	2 (250N)	+++	++++	++++	UL-94 HB 	IP 67	9 - 26
<b>GIG PP Black</b>	Polypropylene PP-Mod	-	-40 °C	+135 °C	1 (125N)	1 (0,5J)	1 (100N)	++++	++++	++++	UL-94 V2 	IP 67	9 - 27
<b>GIG PUR Black</b>	Polyurethane TPU Halogen free	-	-40 °C	+125 °C	1 (125N)	1 (0,5J)	1 (100N)	++++	++++	++++	UL-94 HB 	IP 67	9 - 28

# Product selection table

## Anamet heat protection products

PRODUCT	MATERIAL	MATERIAL	TEMPERATURE CONTINUE		TEMPERATURE SHORT TERM		RESISTANCE		APPROVALS	PAGE
			Min.	Max.	20 min.	15-30 sec.	Oil	Splash		
Type	Core	Cover								
<b>Hiprojacket Aero</b>	Glass fibre	Silicone Halogen free RoHS	-55 °C	+260 °C	+800 °C	+1640 °C	++++	++++	 	10 - 4 till 10 - 5
<b>Hiprojacket Industrial</b>	Glass fibre	Silicone Halogen free RoHS	-55 °C	+260 °C	+800 °C	+1640 °C	++++	++++		10 - 6 till 10 - 7
<b>Hiprojacket Light</b>	Glass fibre	Silicone Halogen free RoHS	-55 °C	+260 °C	+538 °C	+1200 °C	++++	++		10 - 10
<b>Hiprosiltape</b>	Silicone	Silicone Halogen free RoHS	-55 °C	+260 °C	-	-	++++	++		10 - 11
<b>Hiprotape</b>	Glass fibre	Silicone Halogen free RoHS	-55 °C	+260 °C	+800 °C	+1640 °C	++++	++++		10 - 12 till 10 - 13
<b>Hiproblanket Wrap H</b>	Glass fibre	Silicone Halogen free RoHS	-55 °C	+260 °C	+800 °C	+1640 °C	++++	++++		10 - 14 till 10 - 15
<b>Hiproblanket Wrap M</b>	Glass fibre	Silicone Halogen free RoHS	-55 °C	+230 °C	+800 °C	+1640 °C	++++	++		10 - 16
<b>Hiproblanket Wrap Light</b>	Glass fibre	Silicone Halogen free RoHS	-55 °C	+260 °C	+538 °C	+1200 °C	++++	++		10 - 17
<b>Thermo jacket</b>	Glass fibre saturated	-	-55 °C	+538 °C	-	-	-	-		10 - 18
<b>Silicajacket</b>	Silica fibre	-	-55 °C	+980 °C	-	-	-	-		10 - 22
<b>Basaltjacket</b>	Knitted basalt yarn	-	-260 °C	+750 °C	-	+980 °C	-	-		10 - 23
<b>Hiproblanket Heavy</b>	Glass fibre	Silicone Halogen free RoHS	-55 °C	+260 °C	+800 °C	+1640 °C	++++	++++		10 - 24
<b>Hiproblanket Medium</b>	Glass fibre	Silicone Halogen free RoHS	-55 °C	+260 °C	+800 °C	+1640 °C	++++	++++		10 - 25
<b>Hiproblanket Medium Aluminum</b>	Glass fibre	Aluminum	-55 °C	+200 °C	600 °C	-	-	-		10 - 27
<b>Hiproblanket light</b>	Glass fibre	Silicone Halogen free RoHS	-55 °C	+260 °C	+800 °C	+1200 °C	++++	++		10 - 28
<b>Silicablanket</b>	Silica fibre	-	-55 °C	+1090 °C	-	-	-	-		10 - 29









## Company profile

Anamet Europe BV is a specialist in the field of flexible hoses for the transfer of fluids and gases as well as conduit systems for the protection of electrical cables. As a part of Anamet Inc. we are able to service and support our customers worldwide with our specialism and solve all sorts of technical problems with the installation and protection of hoses, piping and cables in a variety of applications.

As a manufacturer of these systems we are not only able to supply the necessary components but are also able to deliver assembled products fully in accordance with your specifications. For over 70 years we have supplied flexible hose systems into steelworks, power plants, machine builders, trains, automotive, oil & gas, military and food equipment. This experience and our drive to work closely together with our customers to find the optimum solution to their needs has made us a specialist in flexible hose connections.



## Quality

By the implementation of a quality system based on the international standard ISO 9001:2015 we do not only assure that our products fully comply to your requirements, but also that we are continuously working to improve our internal processes and service levels to enable us to satisfy your highest demands. Our manufacturing facility is located in Amsterdam, the Netherlands. Our production conforms to the latest standards and is executed by highly qualified personnel.

## Design

Do you have a problem in the field of flexible connections? Be sure to make the right choice, not by simply selecting a supplier, but by selecting the right "partner". Choose for Anamet Europe BV. A team of well trained and enthusiastic engineers is waiting to assist you. By using Computer Aided Design in combination with the various research- and test methods in our laboratory, we will jointly define the best solution to your problem.





## Product facilities

In our production facility in Amsterdam we avail of a wide range of production- and test equipment. We can provide mechanical machining such as cutting, rolling, grinding, winding, braiding, drilling and turning but also connecting techniques such as TIG- and MIG welding, spot welding, glueing, soldering and crimping.

With our qualified production workers we are able to manufacture and supply the full range of metal hoses according to customer specifications. Whether these are large series of standard hoses for the building and construction industry or highly qualified single hoses for specialistic applications in the petrochemical industry, in diameters from 1/4" up/incl. 14", in stainless steel, bronze or monel; we stand ready to serve you.



## Anaconda Sealtite products

One of the best known products of Anamet worldwide, is the Anaconda Sealtite conduit, which in combination with a broad range of Anaconda fittings, provides a durable and liquid tight protection for cabling in a variety of applications. Anaconda Sealtite, a flexible liquid tight conduit, consisting of a spirally wound interlocking metal inner core with an extruded liquid tight cover, is available in a wide range of variations.

Whether you need protection against oil, dust, chemicals, heat and cold, radiation, explosive environments, shielding against EMC, zero halogen covers, or just mechanical protection and ease of installation, we have a solution for every specific need. For high demand markets like the train industry, nuclear power plants, military or shipbuilding we have specific solutions. These products are tested and approved for each of these specific application areas. As the environment is an important issue for us, we offer a full range, produced worldwide in conformity to the European guideline RoHS. We also have a range of products approved by the Underwriters Lab. and Canadian Standard Association for equipment that is exported to the USA or Canada.





In addition we have a full range of non-covered metal conduits and a full plastic-line (with e.g. polyamide) and a complete range of matching fittings and accessories for each of the conduits in our program. Unique are our Anaflex click fittings, power- and proximity switch adapters, stainless steel fittings in straight, 45° and 90° as well our ATEX approved explosion proof fittings. The majority of the products in our program are available from stock. Our team of experts stands ready at any time, to give you advice on the most suitable product for your specific application, thus providing you with the best guarantee for the continuation of your production processes.

## Heat protective products

Anamet Europe invests in the continuous improvement of its flexible conduit solutions to deliver superior products that meet the precise requirements of its clients. It has developed a full range of sleeves, tapes, wraps and blankets in various qualities to protect against heat or provide insulation. Each is designed for use in custom solutions so you always find what you need for your market and your application. Our Hiprojacket sleeves and Hiproblankets can withstand temperatures from +260 °C continuously till +800 °C for approx. 20 minutes and even +1640 °C for 15-30 seconds. In addition we offer Thermojacket, made from woven glass fibre saturated with a high temperature resistant coating, which can withstand +538 °C on a continuous basis. These products are suitable for protection of cables and wires, hydraulic hoses and air piping against intense heat radiation and the hazard of molten metal splashes.





## Stainless steel metal hoses

Anamet Europe B.V. corrugated stainless steel metal hoses have various industrial applications where high demands are set for movement, absorption of vibration or compensation to misalignment of piping systems.







































The advantage of stainless steel metal hoses compared to rubber and plastic hoses are the high temperature resistance of -200 °C till +600 °C as well as their chemical resistance to many aggressive fluids and gasses. They are diffuse tight and not sensitive for aging. These specific characteristics in combination with our design capabilities make our products into one of the most reliable flexible connections. Metal hoses are often used under extreme conditions. To prevent premature failure we can supply many optional accessories like protective casing, spring wire, isolation, shrink sleeve, liners or heat protection covers.



**Anaconda**  
**Multiflex**

# Conduit selection table

## Anaconda Multiflex

MULTIFLEX	MATERIAL	MATERIAL	TEMPERATURE		RESISTANCE (NEN-EN-IEC 61386)			FLEXI- BILITY	RESISTANCE		APPROVALS	PROTEC- TION	PAGE
			Core	Cover	Min.	Max.	Compr.		Impact	Tensile			
<b>FCEN</b>	Galvanised steel	-	-55 °C	+300 °C	4 (1250N)	4 (6J)	4 (1000N)	++++	++++	++++	  	IP 40	1 - 3
<b>SL</b>	Galvanised steel	-	-55 °C	+300 °C	4 (1250N)	4 (6J)	4 (1000N)	+++	++++	++++	  	IP 40	1 - 11
<b>SLI</b>	Stainless steel AISI-304	-	-100 °C	+600 °C	4 (1250N)	4 (6J)	4 (1000N)	+++	++++	++++	  	IP 40	1 - 12
<b>SLI-316</b>	Stainless steel AISI-316	-	-100 °C	+600 °C	4 (1250N)	4 (6J)	4 (1000N)	+++	++++	++++	  	IP 40	1 - 19
<b>SLI-CAP</b>	Stainless steel AISI-304	-	-100 °C	+600 °C	3 (750N)	3 (2J)	3 (500N)	++++	++++	++++	  	IP 40	1 - 22
<b>SLB</b>	Galvanised steel with stainless- steel braid	-	-55 °C	+300 °C	4 (1250N)	4 (6J)	4 (1000N)	++++	++++	++++	  	IP 40	1 - 27
<b>UIG</b>	Galvanised steel	-	-55 °C	+300 °C	5 (4000N)	4 (6J)	4 (1000N)	++++	++++	++++	  	IP 40	1 - 29
<b>UI</b>	Stainless steel AISI-304	-	-100 °C	+600 °C	5 (4000N)	4 (6J)	4 (1000N)	++++	++++	++++	  	IP 40	1 - 30
<b>UI-CAP</b>	Stainless steel AISI-304	-	-100 °C	+600 °C	5 (4000N)	4 (6J)	4 (1000N)	++++	++++	++++	  	IP 40	1 - 42
<b>RWS</b>	Galvanised steel	-	-45 °C	+230 °C	4 (1250N)	4 (6J)	3 (500N)	++	++++	++++	   	IP 40	1 - 47
<b>RWA</b>	Aluminium	-	-45 °C	+260 °C	4 (1250N)	4 (6J)	3 (500N)	++	++++	++++	   	IP 40	1 - 48
<b>Anaflex</b>	Stainless steel AISI-316L	-	-70 °C	+250 °C	3 (750N)	3 (2J)	4 (1000N)	++++	++++	++++	   	IP 69	1 - 51

The fittings for Multiflex are outlined on the next page after the conduit and/or in chapter 5.



# Anaconda Multiflex conduit

## TYPE FCEN



Anaconda  
Multiflex

### VERY FLEXIBLE AND ROBUST

FCEN is a galvanised steel square locked conduit. This general purpose conduit is very flexible and has many applications in industrial applications, construction, underfloor wiring systems, industrial machines. Since FCEN is a conduit without a plastic cover, it is inherently fire retardant and is a good solution for tunnel, rail and underground applications, in situations where a high IP rating is not required. Type FCEN meets the requirements set for London Underground LUL 1-085 and EN45545.

#### Material & Construction:

**Construction:** Galvanised steel core, square locked.

**Special flame properties:** Because the FCEN conduit hose has no cover the flame properties according the following standards are valid:

- EN 45545-2 (2013):  
R22: (interior equipment) class HL1, HL2 and HL3.  
R23: (exterior equipment) class HL1, HL2 and HL3.

- BS 6853 (1999):  
Tabel 7: (Interior) Category 1a, 1b and II vehicle.  
Tabel 8: (Exterior) Category 1a, 1b and II vehicle.
- London Underground LUL 1-085 (2011):  
Tabel 3: Extensive and grouped usage.  
Tabel 4: Limited and dispersed usage.

**Temperature:** -55 °C till +300 °C.

**Colour:** Metal coloured.

#### Classification according to NEN-EN-IEC 61386:

**Compression resistance:** Class 4, Heavy (1250 N).

**Impact resistance:** Class 4, Heavy (6 J).

**Tensile strength:** Class 4, Heavy (1000 N).

**Protection class:** IP 40.



Square locked

FCEN	DIAMETRE		BENDING RADIUS [CL]		SMALL REEL		STANDARD REEL		LARGE REEL		WEIGHT	
	Size (dn)	Inside (mm)	Outside (mm)	Static (mm)	Dynamic (mm)	Metre	Article No.	Metre	Article No.	Metre		Article No.
10	7	9	20	30	-	-	-	-	-	50	370.010.5	0,1
12	10	13	30	45	-	-	25	370.012.2	50	370.012.5	0,15	
16	13	16	45	60	10	370.016.1	25	370.016.2	50	370.016.5	0,2	
20	17	20,5	50	70	10	370.020.1	25	370.020.2	50	370.020.5	0,26	
25	21,2	25	60	80	10	370.025.1	25	370.025.2	50	370.025.5	0,3	
32	28,1	32	70	90	10	370.032.1	25	370.032.2	-	-	0,42	
40	37,7	43	90	120	10	370.040.1	25	370.040.2	-	-	0,6	
50	48,4	54	110	140	10	370.050.1	25	370.050.2	-	-	0,9	

The fittings for FCEN are outlined in on pages 1 - 4 till 1 - 10

FCEN	10	12	16	18	20	25	32	40	50
ISO	M10 - M12	M12 - M16	M16 - M20	M20	M20	M25	M32	M40	M50 - M63
PG	7	9	11/13,5	13,5	16	21	29	36	48
NPT	-	-	1/2"	-	1/2"	3/4"	1"	-	-

# 2 Piece fittings for FCEN, IP 40, nickel plated brass



## ANACONDA NICKEL PLATED BRASS FITTINGS FOR MULTIFLEX FCEN

These nickel plated brass Anamet fittings are similar to the standard fittings for Multitite type FCE, only the caps are adjusted to be used with Multiflex type FCEN. The nickel plated brass FCEN fittings are a cost effective 2 piece fitting giving a strong fix into the conduit with IP 40 rating. In addition to the mentioned straight fittings, other types or custom made solutions are also possible.

### Material & Construction:

**Construction:** Nickel plated brass fitting, consisting of 2 parts (cap and body).

**Material:** Cap and body are nickel plated brass.

**Temperature:** -55 °C till +260 °C continuous.

**Protection class:** IP 40.

**Colour:** Metal coloured.

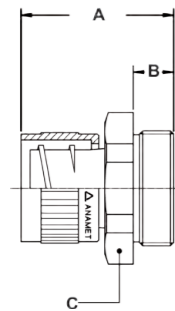

ISO straight fitting, fixed, male, nickel plated brass



THREAD ISO	FCEN SIZE (DN)	MIN. INTERNAL BORE (MM)	DIMENSIONS IN MM					STANDARD PACKAGE	ARTICLE NUMBER	WEIGHT (KG/100)
			A	B	C	D	E			
M10 x 1,0	10	5,5	24	8	14	-	-	10	256.010.0	1,3
M12 x 1,5	10	5,5	24	8	14	-	-	10	256.011.0	1,4
M12 x 1,5	12	8,5	26	10	18	-	-	10	256.012.0	1,8
M16 x 1,5	12	8,5	26	10	18	-	-	10	256.015.0	2
M16 x 1,5	16	11,2	27	10	20	-	-	10	256.016.0	2,3
M20 x 1,5	16	11,2	27	10	22	-	-	10	256.017.0	2,6
M20 x 1,5	20	15,2	27	10	24	-	-	10	256.020.0	3
M25 x 1,5	25	19,2	32	12	30	-	-	5	256.025.0	5,4
M32 x 1,5	32	25,9	35	13	38	-	-	5	256.032.0	8,1
M40 x 1,5	40	34,8	41	14	48	-	-	1	256.040.0	15
M50 x 1,5	50	44,8	45	15	60	-	-	1	256.050.0	22,4
M63 x 1,5	50	44,8	46	16	70	-	-	1	256.060.0	28,6

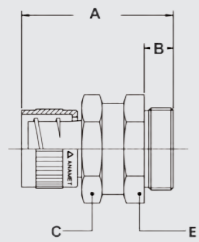

ISO straight fitting, swivel, male, nickel plated brass



THREAD ISO	FCEN SIZE (DN)	MIN. INTERNAL BORE (MM)	DIMENSIONS IN MM					STANDARD PACKAGE	ARTICLE NUMBER	WEIGHT (KG/100)
			A	B	C	D	E			
M10 x 1,0	10	5,5	30	8	14	-	14	10	256.110.0	1,7
M12 x 1,5	10	5,5	30	8	14	-	14	10	256.111.0	1,9
M12 x 1,5	12	8,5	34	10	18	-	18	10	256.112.0	2,4
M16 x 1,5	12	8,5	34	10	18	-	18	10	256.115.0	3,1
M16 x 1,5	16	11,2	36	10	20	-	20	10	256.116.0	3,9
M20 x 1,5	16	11,2	36	10	20	-	22	10	256.117.0	4,2
M20 x 1,5	20	15,2	37	10	24	-	24	10	256.120.0	4,9
M25 x 1,5	25	19,2	43	12	30	-	30	5	256.125.0	8,8
M32 x 1,5	32	25,9	47	13	38	-	38	5	256.132.0	13,3
M40 x 1,5	40	34,8	56	14	48	-	48	1	256.140.0	25,1
M50 x 1,5	50	44,8	60	15	60	-	60	1	256.150.0	36,7
M63 x 1,5	50	44,8	61	16	60	-	70	1	256.160.0	47,1



## 2 PIECE FITTINGS FOR FCEN, IP 40, NICKEL PLATED BRASS

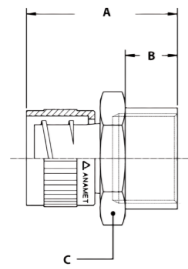

ISO straight fitting, fixed, female, nickel plated brass



THREAD ISO	FCEN SIZE (DN)	MIN. INTERNAL BORE (MM)	DIMENSIONS IN MM					STANDARD PACKAGE	ARTICLE NUMBER	WEIGHT (KG/100)
			A	B	C	D	E			
M12 x 1,5	12	8,5	26	11	18	-	-	10	256.312.0	1,9
M16 x 1,5	12	8,5	28	13	20	-	-	10	256.315.0	2,1
M16 x 1,5	16	11,2	29	13	20	-	-	10	256.316.0	2,4
M20 x 1,5	16	11,2	30	13	24	-	-	10	256.317.0	3
M20 x 1,5	20	15,2	30	13	24	-	-	10	256.320.0	3,2
M25 x 1,5	25	19,2	34	15	30	-	-	5	256.325.0	5,9
M32 x 1,5	32	25,9	38	16	38	-	-	5	256.332.0	8,5
M40 x 1,5	40	34,8	43	16	48	-	-	1	256.340.0	16,6
M50 x 1,5	50	44,8	47	17	60	-	-	1	256.350.0	24,5

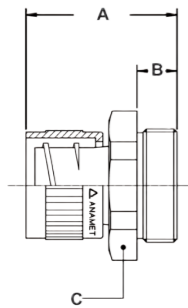

Pg straight fitting, fixed, male, nickel plated brass



THREAD PG	FCEN SIZE (DN)	MIN. INTERNAL BORE (MM)	DIMENSIONS IN MM					STANDARD PACKAGE	ARTICLE NUMBER	WEIGHT (KG/100)
			A	B	C	D	E			
Pg 7	10	5,5	24	8	14	-	-	10	256.407.0	1,3
Pg 9	12	8,5	26	10	18	-	-	10	256.409.0	1,9
Pg 11	16	11,2	27	10	20	-	-	10	256.411.0	2,4
Pg 16	20	15,2	27	10	24	-	-	10	256.416.0	3,2
Pg 21	25	19,2	32	12	30	-	-	5	256.421.0	5,5
Pg 29	32	25,9	35	13	40	-	-	5	256.429.0	8,9
Pg 36	40	34,8	41	14	50	-	-	1	256.436.0	19
Pg 48	50	44,8	45	16	65	-	-	1	256.448.0	25,3

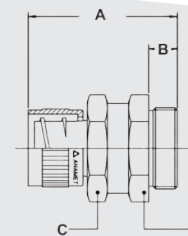

Pg straight fitting, swivel, male, nickel plated brass



THREAD PG	FCEN SIZE (DN)	MIN. INTERNAL BORE (MM)	DIMENSIONS IN MM					STANDARD PACKAGE	ARTICLE NUMBER	WEIGHT (KG/100)
			A	B	C	D	E			
Pg 7	10	5,5	30	8	14	-	14	10	256.507.0	1,8
Pg 9	12	8,5	34	10	18	-	18	10	256.509.0	3
Pg 11	16	11,2	36	10	20	-	20	10	256.511.0	4
Pg 16	20	15,2	37	10	24	-	24	10	256.516.0	5,2
Pg 21	25	19,2	43	12	30	-	30	5	256.521.0	9,2
Pg 29	32	25,9	47	13	38	-	40	5	256.529.0	14,6
Pg 36	40	34,8	56	14	48	-	50	1	256.536.0	27,3
Pg 48	50	44,8	61	16	60	-	65	1	256.548.0	43,8

## 2 PIECE FITTINGS FOR FCEN, IP 40, NICKEL PLATED BRASS

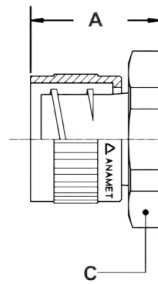

Box connector, fixed, nickel plated brass



THREAD	FCEN SIZE (DN)	MIN. INTERNAL BORE (MM)	DIMENSIONS IN MM					STANDARD PACKAGE	ARTICLE NUMBER	WEIGHT (KG/100)
			A	B	C	D	E			
-	10	5,5	16	-	14	-	-	10	256.610.0	1
-	12	8,5	16	-	18	-	-	10	256.612.0	1,4
-	16	11,2	17	-	20	-	-	10	256.616.0	1,7
-	20	15,2	17	-	24	-	-	10	256.620.0	2,5
-	25	19,2	20	-	30	-	-	5	256.625.0	4
-	32	25,9	22	-	38	-	-	5	256.632.0	6,1
-	40	34,8	27	-	48	-	-	1	256.640.0	11,6
-	50	44,8	30	-	60	-	-	1	256.650.0	18

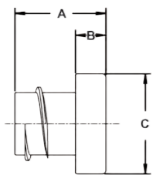

End cap, nickel plated brass



THREAD	FCEN SIZE (DN)	MIN. INTERNAL BORE (MM)	DIMENSIONS IN MM					STANDARD PACKAGE	ARTICLE NUMBER	WEIGHT (KG/100)
			A	B	C	D	E			
-	10	5,5	18	6	13	-	-	10	264.110.0	0,4
-	12	8,5	18	6	17	-	-	10	264.112.0	0,4
-	16	11,2	18	6	20	-	-	10	264.116.0	0,8
-	20	15,2	19	6	24	-	-	10	264.120.0	1,2
-	25	19,2	21	7	30	-	-	5	264.125.0	1,8
-	32	25,9	22	8	38	-	-	5	264.132.0	2,9
-	40	34,8	24	8	49	-	-	2	264.140.0	5,2
-	50	44,8	25	8	60	-	-	2	264.150.0	7,6

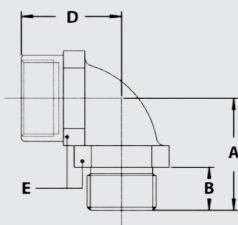

90° elbow, ISO, inside / outside thread, nickel plated brass



OUTSIDE THREAD	INSIDE THREAD	MIN. INTERNAL BORE (MM)	DIMENSIONS IN MM					STANDARD PACKAGE	ARTICLE NUMBER	WEIGHT (KG/100)
			A	B	C	D	E			
M16 x 1,5	M16 x 1,5	-	26	10	-	24	22	10	783.016.0	6
M20 x 1,5	M20 x 1,5	-	26	10	-	25	24	10	783.020.0	10
M25 x 1,5	M25 x 1,5	-	32	10	-	34	33	5	783.025.0	16
M32 x 1,5	M32 x 1,5	-	40	12	-	40	42	5	783.032.0	26

# Compact fittings for FCEN, IP 40, nickel plated brass



## ANACONDA COMPACT FITTINGS, IP 40, NICKEL PLATED BRASS FOR MULTIFLEX FCEN

These nickel plated brass Anaconda compact fittings are the same as used in chapter 5 (compact Sealtite). By replacing the standard polyamide clamping ring with a metal clamping ring and the ferrule (see connection sets below) they can be used with FCEN conduits. By using the FCEN connection set consisting of a special clamping ring and ferrule, a very high pull-out strength is achieved. The high quality finish of these nickel plated brass fittings protects them very well against corrosion and gives them a nicer appearance in comparison with the 2 piece fittings.

### Material & Construction:

**Construction:** Nickel plated brass fitting, consisting of 4 parts (counter nut, clamping ring, ferrule and body). The ferrule and clamping ring are from passivated brass. The clamping rubbers of the cable-hose fittings are made from EPDM.

**Special approvals:** The cable-hose fittings have clamping rubbers from flame retardant VO-rated EPDM and are HL1, HL2 and HL3 according to EN 45545-2, R22 and R23.

**Temperature:** -55 °C till +260 °C continuous. Cable-hose fittings are from -55 °C till +125 °C continuous.

**Protection class:** IP 40. Cable-hose fittings are IP 68 on the switchbox.

**Colour:** Metal coloured.

Connection set, passivated brass, for combination with Multiflex type FCEN



THREAD ISO	FCEN SIZE (DN)	MIN. INTERNAL BORE (MM)	FITTING THREAD SIZE			STANDARD PACKAGE	ARTICLE NUMBER	WEIGHT (KG/100)
			ISO	Pg	NPT			
-	12	8,3	M16 x 1,5	Pg 11	1/2" NPT	10	817.112.0	1,8
-	16	11,2	M16 x 1,5	Pg 11	1/2" NPT	10	817.116.0	2,2
-	20	15,2	M20 x 1,5	Pg 16	1/2" NPT	10	817.120.0	2,6
-	25	19,2	M25 x 1,5	Pg 21	3/4" NPT	5	817.125.0	3,8
-	32	25,9	M32 x 1,5	Pg 29	1" NPT	5	817.132.0	4,2

The above mentioned connection sets for FCEN can be used with all types of compact fittings, as outlined in chapter 5.

ISO straight compact fitting, male, nickel plated brass (incl. brass connection set)



THREAD ISO	FCEN SIZE (DN)	MIN. INTERNAL BORE (MM)	DIMENSIONS IN MM					STANDARD PACKAGE	ARTICLE NUMBER	WEIGHT (KG/100)
			A	B	C	D	E			
M16 x 1,5	12	8,3	31	10	26	-	24	10	712.015.3	5,7
M20 x 1,5	12	8,3	31	10	26	-	24	10	712.014.3	5,8
M16 x 1,5	16	11,2	31	10	26	-	24	10	712.016.3	6,1
M20 x 1,5	16	11,2	31	10	26	-	24	10	712.017.3	6,2
M20 x 1,5	20	15,2	32	10	29	-	27	10	712.020.3	7
M25 x 1,5	25	19,2	33	10	35	-	33	5	712.025.3	10,4
M32 x 1,5	32	25,9	36	12	45	-	42	5	712.032.3	15,9

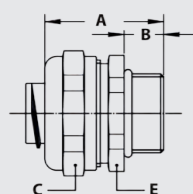

## COMPACT FITTINGS FOR FCEN, IP 40, NICKEL PLATED BRASS

ISO cable-hose fitting, compact, male, double seal acc. EN 45545-2, HL1 / HL2 / HL3, table R22 and R23 (incl. brass connection set)

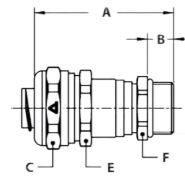

THREAD ISO	FCEN SIZE (DN)	CLAMPING RANGE (MM)	DIMENSIONS IN MM					STANDARD PACKAGE	ARTICLE NUMBER	WEIGHT (KG/100)
			A	B	C	E	F			
M16 x 1,5	12	4,0 - 8,3	50	10	26	24	18	10	712.715.3	8,6
M20 x 1,5	12	4,0 - 8,3	50	10	26	24	22	10	712.714.3	9,2
M16 x 1,5	16	4,0 - 9,5	50	10	26	24	18	10	712.716.3	9
M20 x 1,5	16	4,0 - 9,5	50	10	26	24	22	10	712.717.3	9,6
M20 x 1,5	20	6,0 - 13,0	53	10	29	27	22	10	712.720.3	10,2
M25 x 1,5	20	6,0 - 13,0	54	10	29	27	27	5	712.722.3	11,6
M25 x 1,5	25	11,0 - 18,0	56	10	35	33	27	5	712.725.3	15,5
M32 x 1,5	25	11,0 - 18,0	58	12	35	33	35	5	712.728.3	18,8
M32 x 1,5	32	16,0 - 25,0	61	12	45	42	35	5	712.732.3	24,5
M40 x 1,5	32	16,0 - 25,0	63	13	45	42	43	2	712.735.3	28,7

ISO straight swivel fitting, male, nickel plated brass (incl. brass connection set)

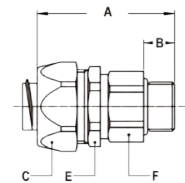

THREAD ISO	FCEN SIZE (DN)	MIN. INTERNAL BORE (MM)	DIMENSIONS IN MM					STANDARD PACKAGE	ARTICLE NUMBER	WEIGHT (KG/100)
			A	B	C	E	F			
M16 x 1,5	12	8,3	48	10	26	24	21	10	813.015.3	9,9
M16 x 1,5	16	10,7	48	10	26	24	21	10	813.016.3	10,3
M20 x 1,5	20	13,9	49	10	29	27	25	10	813.020.3	12,8
M25 x 1,5	25	17,4	49	10	35	33	31	5	813.025.3	17,6
M32 x 1,5	32	23,4	55	12	45	42	38	5	813.032.3	36,7

ISO 90° fitting, compact, male, nickel plated brass (including brass connection set)

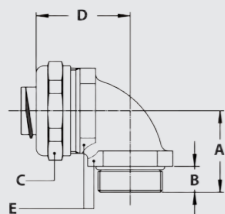

THREAD ISO	FCEN SIZE (DN)	MIN. INTERNAL BORE (MM)	DIMENSIONS IN MM					STANDARD PACKAGE	ARTICLE NUMBER	WEIGHT (KG/100)
			A	B	C	D	E			
M16 x 1,5	12	8,3	26	10	26	31	22	10	712.915.3	8,4
M20 x 1,5	12	8,3	26	10	26	32	24	10	712.914.3	9,7
M16 x 1,5	16	11,2	26	10	26	31	22	10	712.916.3	8,8
M20 x 1,5	16	11,2	26	10	26	32	24	10	712.917.3	10,1
M20 x 1,5	20	15,2	28	10	29	34	27	10	712.920.3	11,8
M25 x 1,5	25	19,2	32	10	35	40	33	5	712.925.3	20
M32 x 1,5	32	25,9	40	12	45	49	42	5	712.932.3	32



## COMPACT FITTINGS FOR FCEN, IP 40, NICKEL PLATED BRASS

ISO 90° swivel fitting, compact, male, nickel plated brass  
(incl. brass connection set)

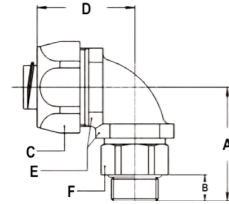

THREAD ISO	FCEN SIZE (DN)	MIN. INTERNAL BORE (MM)	DIMENSIONS IN MM						STANDARD PACKAGE	ARTICLE NUMBER	WEIGHT (KG/100)
			A	B	C	D	E	F			
M16 x 1,5	12	8,3	39	10	26	35	22	21	10	813.915.3	12,6
M16 x 1,5	16	10,7	39	10	26	35	22	21	10	813.916.3	13
M20 x 1,5	20	13,9	39	10	29	37	27	25	10	813.920.3	15,8
M25 x 1,5	25	17,4	46	10	35	44	33	31	5	813.925.3	26,6
M32 x 1,5	32	23,4	55	12	45	55	42	38	5	813.932.3	45,6

Pg straight compact fitting, male, nickel plated brass  
(incl. brass connection set)

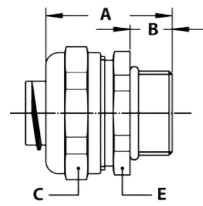

THREAD PG	FCEN SIZE (DN)	MIN. INTERNAL BORE (MM)	DIMENSIONS IN MM					STANDARD PACKAGE	ARTICLE NUMBER	WEIGHT (KG/100)
			A	B	C	D	E			
Pg 11	12	8,3	30	10	26	-	24	10	710.012.3	5,8
Pg 13,5	12	8,3	30	10	26	-	24	10	710.014.3	6
Pg 11	16	11,2	30	10	26	-	24	10	710.011.3	6,2
Pg 13,5	16	11,2	30	10	26	-	24	10	710.013.3	6,4
Pg 16	20	15,2	32	10	29	-	27	10	710.016.3	7,1
Pg 21	25	19,2	33	10	35	-	33	5	710.021.3	10,3
Pg 29	32	25,9	36	12	45	-	44	5	710.029.3	16,4

Pg 90° fitting, compact, male, nickel plated brass  
(incl. brass connection set)

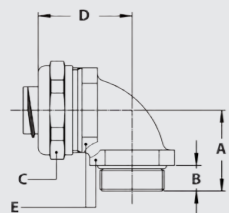

THREAD PG	FCEN SIZE (DN)	MIN. INTERNAL BORE (MM)	DIMENSIONS IN MM					STANDARD PACKAGE	ARTICLE NUMBER	WEIGHT (KG/100)
			A	B	C	D	E			
Pg 11	12	8,3	26	10	26	32	24	10	710.912.3	9,5
Pg 13,5	12	8,3	26	10	26	32	24	10	710.914.3	9,8
Pg 11	16	11,2	26	10	26	32	24	10	710.911.3	9,9
Pg 13,5	16	11,2	26	10	26	32	24	10	710.913.3	10,2
Pg 16	20	15,2	28	10	29	34	27	10	710.916.3	11,8
Pg 21	25	19,2	32	10	35	40	33	5	710.921.3	19,5
Pg 29	32	25,9	40	12	45	49	42	5	710.929.3	32,8

## COMPACT FITTINGS FOR FCEN, IP 40, NICKEL PLATED BRASS

NPT straight compact fitting, male, nickel plated brass  
(incl. brass connection set)

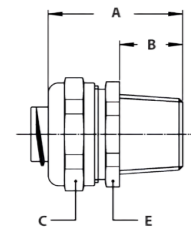

THREAD NPT	FCEN SIZE (DN)	MIN. INTERNAL BORE (MM)	DIMENSIONS IN MM					STANDARD PACKAGE	ARTICLE NUMBER	WEIGHT (KG/100)
			A	B	C	D	E			
NPT 1/2"	16	11,2	35	14	26	-	24	10	714.012.3	6,6
NPT 1/2"	20	15,2	36	14	29	-	27	10	714.016.3	7,6
NPT 3/4"	25	19,2	37	14	35	-	33	5	714.020.3	10,8
NPT 1"	32	25,9	40	16	45	-	42	5	714.026.3	16,8

NPT 90° fitting, compact, male, nickel plated brass  
(incl. brass connection set)

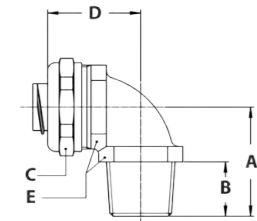

THREAD NPT	FCEN SIZE (DN)	MIN. INTERNAL BORE (MM)	DIMENSIONS IN MM					STANDARD PACKAGE	ARTICLE NUMBER	WEIGHT (KG/100)
			A	B	C	D	E			
NPT 1/2"	16	11,2	30	14	26	32	24	10	714.912.3	10,4
NPT 1/2"	20	15,2	32	14	29	34	27	10	714.916.3	12,2
NPT 3/4"	25	19,2	36	14	35	40	33	5	714.920.3	20,5
NPT 1"	32	25,9	44	16	45	49	42	5	714.926.3	32,5

Conduit connector, nickel plated brass (incl. brass connection set)

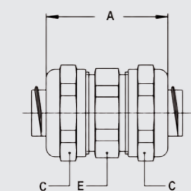

FCEN SIZE (DN)	FCEN SIZE (DN)	MIN. INTERNAL BORE (MM)	DIMENSIONS IN MM					STANDARD PACKAGE	ARTICLE NUMBER	WEIGHT (KG/100)
			A	B	C	D	E			
5/16"	12	8,3	41	-	26	-	24	10	784.010.3	11
3/8"	16	11,2	41	-	26	-	24	10	784.012.3	11,8
1/2"	20	15,2	45	-	29	-	24	10	784.016.3	14
3/4"	25	19,2	48	-	35	-	33	5	784.020.3	20,6
1"	32	25,9	53	-	45	-	44	5	784.026.3	33,6

# Anaconda Multiflex conduit

## TYPE SL



Anaconda  
Multiflex

### FLEXIBLE AND VERY ROBUST

The galvanised steel SL is made from the inner core of Anaconda Sealtite. Type SL is less flexible than Multiflex type FCEN but more robust and provides a high mechanical protection for cables, in those cases where a high IP rating is not required. Typical application areas include metalworking foundries, the machine and apparatus building sector and the indoor close circuit and security industry. SL provides an excellent level of protection against metal swarf, chips and rodents.

#### Material & Construction:

**Construction:** Galvanised steel core, square locked.

**Temperature:** -55 °C till +300 °C.

**Colour:** Metal coloured.

#### Classification according to NEN-EN-IEC 61386:

**Compression resistance:** Class 4, Heavy (1250 N).

**Impact resistance:** Class 4, Heavy (6 J).

**Tensile strength:** Class 4, Heavy (1000 N).

**Protection class:** IP 40.



Square locked

SL	DIAMETRE		BENDING RADIUS (CL)		SMALL CARTON		STANDARD CARTON		LARGE CARTON		WEIGHT (kg/m)
	Size (inch)	Inside (mm)	Outside (mm)	Static (mm)	Dynamic (mm)	Metre	Article No.	Metre	Article No.	Metre	
5/16"	10,1	12,8	50	65	30	107.010.2	-	-	-	-	0,14
3/8"	12,6	15,5	60	85	30	107.012.2	-	-	-	-	0,24
1/2"	16	18,9	75	110	30	107.016.2	-	-	-	-	0,26
3/4"	21	23,9	90	140	30	107.020.2	-	-	-	-	0,41
1"	26,5	30	120	170	30	107.026.2	-	-	-	-	0,55
1 1/4"	35,1	38,7	135	215	30	107.035.2	-	-	-	-	0,63

\* For sizes 1 1/2" and 2" we advise to use the interlocked designed conduit type UIG (see page 1 - 29)

\* On demand the SL conduits are available also in production reels with longer lengths (codes change in 107.xxx.0)

The fittings for SL are outlined in on pages 1 - 13 till 1 - 16

MULTIFLEX	1/4"	5/16"	3/8"	1/2"	3/4"	1"	1 1/4"	1 1/2"	2"	2 1/2"	3"	4"
ISO	M12 - M16	M16 - M20	M16 - M20	M20	M25	M32	M40	M50	M63	M75	M90	M105
PG	7	09 - 11	11 - 13,5	16	21	29	36	42	48	-	-	-
NPT	-	-	1/2"	1/2"	3/4"	1"	1 1/4"	1 1/2"	2"	2 1/2"	3"	4"



# Anaconda Multiflex conduit

## TYPE SLI



### FLEXIBLE AND EXTRA CORROSION RESISTANT

SLI is the stainless steel AISI-304 execution of the SL conduit. This conduit provides high mechanical and chemical protection in applications that require a high degree of corrosion protection. Typical applications include the steel, foundry, marine and shipbuilding industries as well as machine building.

#### Material & Construction:

**Material:** Stainless steel (AISI-304). Also available in AISI-316.  
(see type SLI-316 on page 1 - 19)

**Construction:** Square locked design.  
**Temperature:** -100 °C till +600 °C.  
**Colour:** Metal coloured.

#### Classification according NEN-EN-IEC 61386:

**Compression resistance:** Class 4, Heavy (1250 N).  
**Impact resistance:** Class 4, Heavy (6 J).  
**Tensile strength:** Class 4, Heavy (1000 N).  
**Protection class:** IP 40.



Square locked

SLI	DIAMETRE		BENDING RADIUS (CL)		SMALL CARTON		STANDARD CARTON		LARGE CARTON		WEIGHT (kg/m)
	Size (inch)	Inside (mm)	Outside (mm)	Static (mm)	Dynamic (mm)	Metre	Article No.	Metre	Article No.	Metre	
5/16"	10,1	12,8	50	65	30	600.010.2	-	-	-	-	0,15
3/8"	12,6	15,5	60	85	30	600.012.2	-	-	-	-	0,24
1/2"	16	18,9	75	110	30	600.016.2	-	-	-	-	0,26
3/4"	21	23,9	90	140	30	600.020.2	-	-	-	-	0,41
1"	26,5	30	120	170	30	600.026.2	-	-	-	-	0,55
1 1/4"	35,1	38,7	135	215	30	600.035.2	-	-	-	-	0,63

\* For sizes 1 1/2" and 2" we advise to use the interlocked designed conduit type UI (see page 1 - 30)

\* On demand the SLI conduits are available also in production reels with longer lengths (codes change in 600.xxx.0)

The fittings for SLI are outlined in on pages 1 - 13 till 1 - 18

MULTIFLEX	1/4"	5/16"	3/8"	1/2"	3/4"	1"	1 1/4"	1 1/2"	2"	2 1/2"	3"	4"
ISO	M12 - M16	M16 - M20	M16 - M20	M20	M25	M32	M40	M50	M63	M75	M90	M105
PG	7	09 - 11	11 - 13,5	16	21	29	36	42	48	-	-	-
NPT	-	-	1/2"	1/2"	3/4"	1"	1 1/4"	1 1/2"	2"	2 1/2"	3"	4"

# Compact fittings for SL / SLI, IP 40, nickel plated brass



Anaconda  
Multiflex

## ANACONDA COMPACT NICKEL PLATED BRASS FITTINGS FOR MULTIFLEX SL / SLI

These nickel plated brass Anaconda compact fittings are the same as used in chapter 5 (compact Sealtite). By replacing the standard polyamide clamping ring with a metal clamping ring (see below) they can be used in combination with SL and SLI conduits. By using the SLI clamping ring, a very high pull-out strength is achieved. The high quality finish of these nickel plated brass fittings protects them very well against corrosion and gives a nice appearance.

### Material & Construction:

**Construction:** Nickel plated brass fitting, consisting of 4 parts (counter nut, clamping ring, ferrule and body).

**Temperature:** -55 °C till +260 °C continuous.

**Protection class:** IP 40.

**Colour:** Metal coloured.

**Material:** Counter nut, ferrule and body are nickel plated brass. The ferrule is from galvanised steel.

O-rings are from NBR (black for ISO metric and blue for Pg).



Clamping ring, nickel plated brass, for combination with Multiflex type SL / SLI



THREAD ISO	SL / SLI SIZE (INCH)	MIN. INTERNAL BORE (MM)	FITTING THREAD SIZE			STANDARD PACKAGE	ARTICLE NUMBER	WEIGHT (KG/100)
			ISO	Pg	NPT			
-	5/16"	-	M16 x 1,5	Pg 9	1/2" NPT	10	817.210.6	0,6
-	3/8"	-	M16 x 1,5	Pg 11	1/2" NPT	10	817.213.6	0,6
-	1/2"	-	M20 x 1,5	Pg 16	1/2" NPT	10	817.216.6	0,6
-	3/4"	-	M25 x 1,5	Pg 21	3/4" NPT	5	817.220.6	1
-	1"	-	M32 x 1,5	Pg 29	1" NPT	5	817.226.6	1,2
-	1.1/4"	-	M40 x 1,5	Pg 36	1.1/4" NPT	2	817.235.6	2

The above mentioned clamping rings for SL / SLI can be used with all types of compact fittings, as outlined in chapter 5.

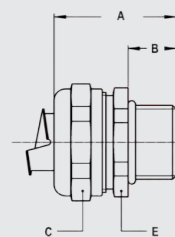

ISO straight compact fitting, male, nickel plated brass (incl. metal clamping ring)



THREAD ISO	SL / SLI SIZE (INCH)	MIN. INTERNAL BORE (MM)	DIMENSIONS IN MM					STANDARD PACKAGE	ARTICLE NUMBER	WEIGHT (KG/100)
			A	B	C	D	E			
M16 x 1,5	5/16"	8,3	31	10	26	-	24	10	712.015.6	6,1
M20 x 1,5	5/16"	8,3	31	10	26	-	24	10	712.014.6	6,2
M16 x 1,5	3/8"	11	31	10	26	-	24	10	712.016.6	4,5
M20 x 1,5	3/8"	11	31	10	26	-	24	10	712.017.6	4,6
M20 x 1,5	1/2"	14,5	32	10	29	-	27	10	712.020.6	5
M25 x 1,5	3/4"	19,4	33	10	35	-	33	5	712.025.6	7,6
M32 x 1,5	1"	24,7	36	12	45	-	42	5	712.032.6	12,9
M40 x 1,5	1.1/4"	33,3	40	13	53	-	50	2	712.040.6	18

## COMPACT FITTINGS FOR SL / SLI, IP 40, NICKEL PLATED BRASS

ISO cable-hose fitting, compact, male, double seal acc. EN 45545-2, HL1 / HL2 / HL3, table R22 and R23 (incl. metal clamping ring)

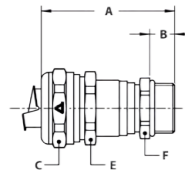

THREAD ISO	SL / SLI SIZE (INCH)	CLAMPING RANGE (MM)	DIMENSIONS IN MM					STANDARD PACKAGE	ARTICLE NUMBER	WEIGHT (KG/100)
			A	B	C	E	F			
M16 x 1,5	5/16"	4,0 - 8,3	50	10	26	24	18	10	712.715.6	9
M20 x 1,5	5/16"	4,0 - 8,3	50	10	26	24	22	10	712.714.6	9,6
M16 x 1,5	3/8"	4,0 - 9,5	50	10	26	24	18	10	712.716.6	7,4
M20 x 1,5	3/8"	4,0 - 9,5	50	10	26	24	22	10	712.717.6	8
M20 x 1,5	1/2"	6,0 - 13,0	53	10	29	27	22	10	712.720.6	8,2
M25 x 1,5	1/2"	6,0 - 13,0	54	10	29	27	27	5	712.722.6	9,6
M25 x 1,5	3/4"	11,0 - 18,0	56	10	35	33	27	5	712.725.6	12,7
M32 x 1,5	3/4"	11,0 - 18,0	58	12	35	33	35	5	712.728.6	16
M32 x 1,5	1"	16,0 - 24,7	61	12	45	42	35	5	712.732.6	21,5
M40 x 1,5	1"	16,0 - 24,7	63	13	45	42	43	2	712.735.6	25,7
M40 x 1,5	1.1/4"	22,0 - 32,0	69	13	53	50	43	2	712.740.6	30,6

ISO straight swivel fitting, male, nickel plated brass (incl. metal clamping ring)

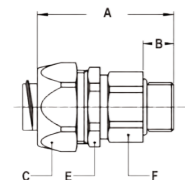

THREAD ISO	SL / SLI SIZE (INCH)	MIN. INTERNAL BORE (MM)	DIMENSIONS IN MM					STANDARD PACKAGE	ARTICLE NUMBER	WEIGHT (KG/100)
			A	B	C	E	F			
M16 x 1,5	5/16"	8,3	48	10	26	24	21	10	813.015.6	10,3
M16 x 1,5	3/8"	10,4	48	10	26	24	21	10	813.016.6	8,7
M20 x 1,5	1/2"	13,9	49	10	29	27	25	10	813.020.6	10,8
M25 x 1,5	3/4"	17,4	49	10	35	33	31	5	813.025.6	14,8
M32 x 1,5	1"	23,4	55	12	45	42	38	5	813.032.6	33,7
M40 x 1,5	1.1/4"	29,4	58	14	54	50	48	2	813.040.6	55

ISO 90° fitting, compact, male, nickel plated brass (incl. metal clamping ring)

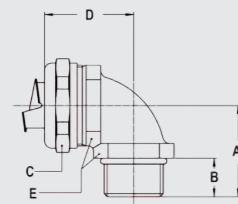

THREAD ISO	SL / SLI SIZE (INCH)	MIN. INTERNAL BORE (MM)	DIMENSIONS IN MM					STANDARD PACKAGE	ARTICLE NUMBER	WEIGHT (KG/100)
			A	B	C	D	E			
M16 x 1,5	5/16"	8,3	26	10	26	31	22	10	712.915.6	8,8
M20 x 1,5	5/16"	8,3	26	10	26	32	24	10	712.914.6	10,1
M16 x 1,5	3/8"	11	26	10	26	31	22	10	712.916.6	7,2
M20 x 1,5	3/8"	11	26	10	26	32	24	10	712.917.6	8,5
M20 x 1,5	1/2"	14,5	28	10	29	34	27	10	712.920.6	9,8
M25 x 1,5	3/4"	19,4	32	10	35	40	33	5	712.925.6	17,2
M32 x 1,5	1"	24,7	40	12	45	49	42	5	712.932.6	29
M40 x 1,5	1.1/4"	33,3	46	13	53	53	52	2	712.940.6	42,1



## COMPACT FITTINGS FOR SL / SLI, IP 40, NICKEL PLATED BRASS

ISO 90° swivel fitting, compact, male, nickel plated brass  
(incl. metal clamping ring)

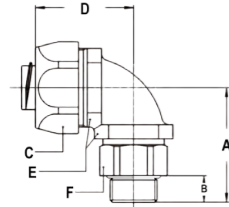

THREAD ISO	SL / SLI SIZE (INCH)	MIN. INTERNAL BORE (MM)	DIMENSIONS IN MM						STANDARD PACKAGE	ARTICLE NUMBER	WEIGHT (KG/100)
			A	B	C	D	E	F			
M16 x 1,5	5/16"	8,3	39	10	26	35	22	21	10	813.915.6	13
M16 x 1,5	3/8"	10,4	39	10	26	35	22	21	10	813.916.6	11,4
M20 x 1,5	1/2"	13,9	39	10	29	37	27	25	10	813.920.6	13,8
M25 x 1,5	3/4"	17,4	46	10	35	44	33	31	5	813.925.6	23,8
M32 x 1,5	1"	23,4	55	12	45	55	42	38	5	813.932.6	42,6

Pg straight compact fitting, male, nickel plated brass  
(incl. metal clamping ring)

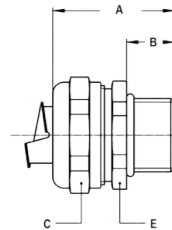

THREAD PG	SL / SLI SIZE (INCH)	MIN. INTERNAL BORE (MM)	DIMENSIONS IN MM					STANDARD PACKAGE	ARTICLE NUMBER	WEIGHT (KG/100)
			A	B	C	D	E			
Pg 11	5/16"	8,3	31	10	26	-	24	10	710.012.6	6,2
Pg 13,5	5/16"	8,3	31	10	26	-	24	10	710.014.6	6,4
Pg 11	3/8"	11	31	10	26	-	24	10	710.011.6	4,6
Pg 13,5	3/8"	11	31	10	26	-	24	10	710.013.6	4,8
Pg 16	1/2"	14,5	32	10	29	-	27	10	710.016.6	5,1
Pg 21	3/4"	19,4	33	10	35	-	33	5	710.021.6	7,5
Pg 29	1"	24,7	36	12	45	-	44	5	710.029.6	13,4
Pg 36	1.1/4"	33,3	40	13	53	-	52	2	710.036.6	18,4

Pg 90° fitting, compact, male, nickel plated brass  
(incl. metal clamping ring)

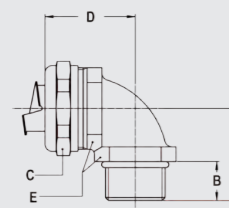

THREAD PG	SL / SLI SIZE (INCH)	MIN. INTERNAL BORE (MM)	DIMENSIONS IN MM					STANDARD PACKAGE	ARTICLE NUMBER	WEIGHT (KG/100)
			A	B	C	D	E			
Pg 11	5/16"	8,3	26	10	26	32	24	10	710.912.6	9,9
Pg 13,5	5/16"	8,3	26	10	26	32	24	10	710.914.6	10,2
Pg 11	3/8"	11	26	10	26	32	24	10	710.911.6	8,3
Pg 13,5	3/8"	11	26	10	26	32	24	10	710.913.6	8,6
Pg 16	1/2"	14,5	28	10	29	34	27	10	710.916.6	9,8
Pg 21	3/4"	19,4	32	10	35	40	33	5	710.921.6	16,7
Pg 29	1"	24,7	40	12	45	49	42	5	710.929.6	29,8
Pg 36	1.1/4"	33,3	46	13	53	53	52	2	710.936.6	42,1

## COMPACT FITTINGS FOR SL / SLI, IP 40, NICKEL PLATED BRASS

NPT straight compact fitting, male, nickel plated brass  
(incl. metal clamping ring)

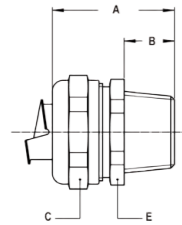

THREAD NPT	SL / SLI SIZE (INCH)	MIN. INTERNAL BORE (MM)	DIMENSIONS IN MM					STANDARD PACKAGE	ARTICLE NUMBER	WEIGHT (KG/100)
			A	B	C	D	E			
NPT 1/2"	3/8"	11	35	14	26	-	24	10	714.012.6	5,4
NPT 1/2"	1/2"	14,5	36	14	29	-	27	10	714.016.6	5,6
NPT 3/4"	3/4"	19,4	37	14	35	-	33	5	714.020.6	8
NPT 1"	1"	24,7	40	16	45	-	42	5	714.026.6	13,8
NPT 1.1/4"	1.1/4"	33,3	43	16	53	-	50	2	714.035.6	18,8

NPT 90° fitting, compact, male, nickel plated brass  
(incl. metal clamping ring)

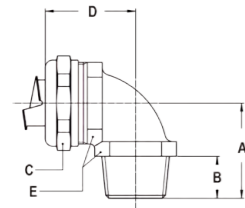

THREAD NPT	SL / SLI SIZE (INCH)	MIN. INTERNAL BORE (MM)	DIMENSIONS IN MM					STANDARD PACKAGE	ARTICLE NUMBER	WEIGHT (KG/100)
			A	B	C	D	E			
NPT 1/2"	3/8"	11	30	14	26	32	24	10	714.912.6	8,8
NPT 1/2"	1/2"	14,5	32	14	29	34	27	10	714.916.6	10,2
NPT 3/4"	3/4"	19,4	36	14	35	40	33	5	714.920.6	17,7
NPT 1"	1"	24,7	44	16	45	49	42	5	714.926.6	29,5
NPT 1.1/4"	1.1/4"	33,3	49	16	53	53	52	2	714.935.6	43,4

Conduit connector, nickel plated brass (including metal clamping ring)

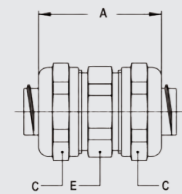

SL / SLI SIZE (INCH)	SL / SLI SIZE (INCH)	MIN. INTERNAL BORE (MM)	DIMENSIONS IN MM					STANDARD PACKAGE	ARTICLE NUMBER	WEIGHT (KG/100)
			A	B	C	D	E			
5/16"	5/16"	8,3	41	-	26	-	24	10	784.010.6	11,8
3/8"	3/8"	10,4	41	-	26	-	24	10	784.012.6	8,6
1/2"	1/2"	13,9	45	-	29	-	24	10	784.016.6	10
3/4"	3/4"	18,5	48	-	35	-	33	5	784.020.6	15
1"	1"	23,8	53	-	45	-	44	5	784.026.6	27,6
1.1/4"	1.1/4"	31,9	58	-	53	-	50	2	784.035.6	36,6

# Compact fittings for SLI, IP 40, stainless steel AISI-304



Anaconda  
Multiflex

## ANACONDA COMPACT FITTINGS, STAINLESS STEEL AISI-304, FOR MULTIFLEX SLI

These stainless steel AISI-304 Anaconda compact fittings are the same as used in chapter 5 (compact Sealtite). By replacing the standard polyamide clamping ring with a metal clamping ring (see below) they can be used in combination with SL and SLI conduits. By using the SLI clamping ring, a very high pull-out strength is achieved. The high quality finish of these stainless steel fittings protects them excellent against corrosion and gives a nice appearance.

### Material & Construction:

**Construction:** Stainless steel AISI-304 fitting, consisting of 4 parts (counter nut, clamping ring, ferrule and body).

**Temperature:** -55 °C till +260 °C continuous.

**Protection class:** IP 40.

**Colour:** Metal coloured.

**Material:** Counter nut, ferrule and body are stainless steel AISI-304. The clamping ring is made of nickel plated brass. O-rings are from NBR (black for ISO metric and blue for Pg).



Clamping ring, nickel plated brass, for combination with Multiflex type SLI



THREAD ISO	SLI SIZE (INCH)	MIN. INTERNAL BORE (MM)	FITTING THREAD SIZE			STANDARD PACKAGE	ARTICLE NUMBER	WEIGHT (KG/100)
			ISO	Pg	NPT			
-	3/8"	-	M16 x 1,5	Pg 11	1/2" NPT	10	817.213.6	0,6
-	1/2"	-	M20 x 1,5	Pg 16	1/2" NPT	10	817.216.6	0,6
-	3/4"	-	M25 x 1,5	Pg 21	3/4" NPT	5	817.220.6	1
-	1"	-	M32 x 1,5	Pg 29	1" NPT	5	817.226.6	1,2
-	1.1/4"	-	M40 x 1,5	Pg 36	1.1/4" NPT	2	817.235.6	2

The above mentioned clamping rings for SLI can be used with all types of compact fittings, as outlined in chapter 5.

ISO straight compact fitting, male, stainless steel AISI-304 (incl. metal clamping ring)

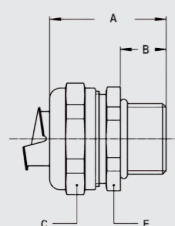

THREAD ISO	SLI SIZE (INCH)	MIN. INTERNAL BORE (MM)	DIMENSIONS IN MM					STANDARD PACKAGE	ARTICLE NUMBER	WEIGHT (KG/100)
			A	B	C	D	E			
M16 x 1,5	3/8"	11	31	10	26	-	24	10	712.016.96	4,5
M20 x 1,5	3/8"	11	31	10	26	-	24	10	712.017.96	4,6
M20 x 1,5	1/2"	14,5	32	10	29	-	27	10	712.020.96	5
M25 x 1,5	3/4"	19,4	33	10	35	-	33	5	712.025.96	7,6
M32 x 1,5	1"	24,7	36	12	45	-	42	5	712.032.96	12,9
M40 x 1,5	1.1/4"	33,3	40	13	53	-	50	2	712.040.96	18
M32 x 1,5	1"	24,7	36	12	45	-	42	5	712.032.96	12,9
M40 x 1,5	1.1/4"	33,3	40	13	53	-	50	2	712.040.96	18

## COMPACT FITTINGS FOR SLI, IP 40, STAINLESS STEEL AISI-304

ISO 90° fitting, compact, male, stainless steel AISI-304  
(incl. metal clamping ring)

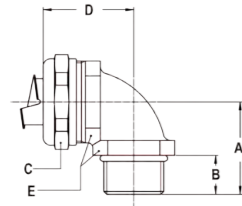

THREAD ISO	SLI SIZE (INCH)	MIN. INTERNAL BORE (MM)	DIMENSIONS IN MM					STANDARD PACKAGE	ARTICLE NUMBER	WEIGHT (KG/100)
			A	B	C	D	E			
M16 x 1,5	3/8"	11,0	26	10	26	31	22	10	712.916.96	7,2
M20 x 1,5	3/8"	11,0	26	10	26	32	24	10	712.917.96	8,5
M20 x 1,5	1/2"	14,5	28	10	29	34	27	10	712.920.96	9,8
M25 x 1,5	3/4"	19,4	32	10	35	40	33	5	712.925.96	17,2
M32 x 1,5	1"	24,7	40	12	45	49	42	5	712.932.96	29,0
M40 x 1,5	1 1/4"	33,3	46	13	53	53	52	2	712.940.96	42,1

NPT straight compact fitting, male, stainless steel AISI-304  
(incl. metal clamping ring)

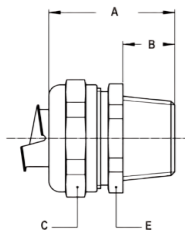

THREAD NPT	SLI SIZE (INCH)	MIN. INTERNAL BORE (MM)	DIMENSIONS IN MM					STANDARD PACKAGE	ARTICLE NUMBER	WEIGHT (KG/100)
			A	B	C	D	E			
NPT 1/2"	3/8"	11,0	35	14	26	-	24	10	714.012.96	5,0
NPT 1/2"	1/2"	14,5	36	14	29	-	27	10	714.016.96	5,6
NPT 3/4"	3/4"	19,4	37	14	35	-	33	5	714.020.96	8,0
NPT 1"	1"	24,7	40	16	45	-	42	5	714.026.96	13,8
NPT 1 1/4"	1 1/4"	33,3	43	16	53	-	50	2	714.035.96	18,8

NPT 90° fitting, compact, male, stainless steel AISI-304  
(incl. metal clamping ring)

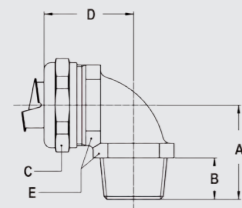

THREAD NPT	SLI SIZE (INCH)	MIN. INTERNAL BORE (MM)	DIMENSIONS IN MM					STANDARD PACKAGE	ARTICLE NUMBER	WEIGHT (KG/100)
			A	B	C	D	E			
NPT 1/2"	3/8"	11,0	30	14	26	32	24	10	714.912.96	8,8
NPT 1/2"	1/2"	14,5	32	14	29	34	27	10	714.916.96	10,2
NPT 3/4"	3/4"	19,4	36	14	35	40	33	5	714.920.96	17,7
NPT 1"	1"	24,7	44	16	45	49	42	5	714.926.96	29,5
NPT 1 1/4"	1 1/4"	33,3	49	16	53	53	52	2	714.935.96	43,4



# Anaconda Multiflex conduit

## TYPE SLI-316



Anaconda  
Multiflex

### FLEXIBLE, STRONG AND VERY HIGH CORROSION RESISTANT

SLI-316 is the stainless steel AISI-316 execution of the SL conduit. This conduit provides a high mechanical and chemical protection in applications that require a very high degree of corrosion protection, but where liquid tightness is not a pre-requirement. Typical applications include the steel, foundry, marine and shipbuilding industries as well as machine building.

#### Material & Construction:

**Material:** Stainless steel (AISI-316).

**Temperature:** -100 °C till +600 °C.

**Construction:** Square locked design.

**Colour:** Metal coloured.

#### Classification according NEN-EN-IEC 61386:

**Compression resistance:** Class 4, Heavy (1250 N).

**Impact resistance:** Class 4, Heavy (6 J).

**Tensile strength:** Class 4, Heavy (1000 N).

**Protection class:** IP 40.



Square locked

SLI-316	DIAMETRE		BENDING RADIUS (CL)		SMALL CARTON		STANDARD CARTON		LARGE CARTON		WEIGHT
	Size (inch)	Inside (mm)	Outside (mm)	Static (mm)	Dynamic (mm)	Metre	Article No.	Metre	Article No.	Metre	
5/16"	10,1	12,8	50	65	30	600.610.2	-	-	-	-	0,15
3/8"	12,6	15,5	60	85	30	600.612.2	-	-	-	-	0,24
1/2"	16	18,9	75	110	30	600.616.2	-	-	-	-	0,26
3/4"	21	23,9	90	140	30	600.620.2	-	-	-	-	0,41
1"	26,5	30	120	170	30	600.626.2	-	-	-	-	0,55
1 1/4"	35,1	38,7	135	215	30	600.635.2	-	-	-	-	0,63

\* On demand the SLI-316 conduits are available also in production reels with longer lengths (codes change in 600.6xx.0)

The fittings for SLI-316 are outlined in on pages 1 - 20 and 1 - 21

MULTIFLEX	1/4"	5/16"	3/8"	1/2"	3/4"	1"	1 1/4"	1 1/2"	2"	2 1/2"	3"	4"
ISO	M12 - M16	M16 - M20	M16 - M20	M20	M25	M32	M40	M50	M63	M75	M90	M105
PG	7	9 - 11	11 - 13,5	16	21	29	36	42	48	-	-	-
NPT	-	-	1/2"	1/2"	3/4"	1"	1 1/4"	1 1/2"	2"	2 1/2"	3"	4"

# Compact fittings for SLI, IP 40, stainless steel AISI-316



## ANACONDA COMPACT FITTINGS, STAINLESS STEEL AISI-316, FOR MULTIFLEX SLI-316

These stainless steel AISI-316 Anaconda compact fittings are the same as used in chapter 5 (compact Sealtite). By replacing the standard polyamide clamping ring with a metal clamping ring (see below) they can be used in combination with SLI and SLI-316 conduits. By using the SLI clamping ring, a very high pull-out strength is achieved. The high quality finish of these stainless steel AISI-316 makes them superior to protect against corrosion and gives a nice appearance.

### Material & Construction:

**Construction:** Stainless steel AISI-316 fitting, consisting of 4 parts (counter nut, clamping ring, ferrule and body).

**Material:** Counter nut, and body are stainless steel AISI-316. The ferrule is from stainless steel AISI-304. The clamping ring is made of nickel

plated brass. O-rings are from NBR (black for ISO metric and blue for Pg).

**Temperature:** -55 °C till +260 °C continuous.

**Protection class:** IP 40.

**Colour:** Metal coloured.



Clamping ring, nickel plated brass, for combination with Multiflex type SLI-316



THREAD ISO	SLI-316 SIZE (INCH)	MIN. INTERNAL BORE (MM)	FITTING THREAD SIZE			STANDARD PACKAGE	ARTICLE NUMBER	WEIGHT (KG/100)
			ISO	Pg	NPT			
-	3/8"	-	M16 x 1,5	Pg 11	1/2" NPT	10	817.213.6	0,6
-	1/2"	-	M20 x 1,5	Pg 16	1/2" NPT	10	817.216.6	0,6
-	3/4"	-	M25 x 1,5	Pg 21	3/4" NPT	5	817.220.6	1
-	1"	-	M32 x 1,5	Pg 29	1" NPT	5	817.226.6	1,2
-	1.1/4"	-	M40 x 1,5	Pg 36	1.1/4" NPT	2	817.235.6	2

The above mentioned clamping rings for SLI-316 can be used with all types of compact fittings, as outlined in chapter 5.

ISO straight compact fitting, male, stainless steel AISI-316 (incl. metal clamping ring)

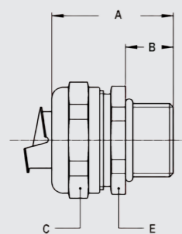

THREAD ISO	SLI-316 SIZE (INCH)	MIN. INTERNAL BORE (MM)	DIMENSIONS IN MM					STANDARD PACKAGE	ARTICLE NUMBER	WEIGHT (KG/100)
			A	B	C	D	E			
M16 x 1,5	3/8"	11	31	10	26	-	24	10	712.116.96	4,5
M20 x 1,5	3/8"	11	31	10	26	-	24	10	712.117.96	4,6
M20 x 1,5	1/2"	14,5	32	10	29	-	27	10	712.120.96	5
M25 x 1,5	3/4"	19,4	33	10	35	-	33	5	712.125.96	7,6
M32 x 1,5	1"	24,7	36	12	45	-	42	5	712.132.96	12,9
M40 x 1,5	1.1/4"	33,3	40	13	53	-	50	2	712.140.96	18

## COMPACT FITTINGS FOR SLI, IP 40, STAINLESS STEEL AISI-316

ISO 90° fitting, compact, male, stainless steel AISI-316  
(incl. metal clamping ring)

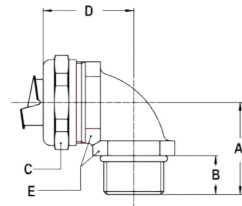

THREAD ISO	SLI-316 SIZE (INCH)	MIN. INTERNAL BORE (MM)	DIMENSIONS IN MM					STANDARD PACKAGE	ARTICLE NUMBER	WEIGHT (KG/100)
			A	B	C	D	E			
M16 x 1,5	3/8"	11	26	10	26	31	22	10	712.516.96	7,2
M20 x 1,5	3/8"	11	26	10	26	32	24	10	712.517.96	8,5
M20 x 1,5	1/2"	14,5	28	10	29	34	27	10	712.520.96	9,8
M25 x 1,5	3/4"	19,4	32	10	35	40	33	5	712.525.96	17,2
M32 x 1,5	1"	24,7	40	12	45	49	42	5	712.532.96	29
M40 x 1,5	1.1/4"	33,3	46	13	53	53	52	2	712.540.96	42,1

NPT straight compact fitting, male, stainless steel AISI-316  
(incl. metal clamping ring)

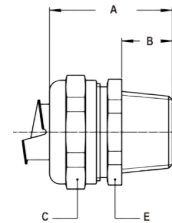

THREAD NPT	SLI-316 SIZE (INCH)	MIN. INTERNAL BORE (MM)	DIMENSIONS IN MM					STANDARD PACKAGE	ARTICLE NUMBER	WEIGHT (KG/100)
			A	B	C	D	E			
NPT 1/2"	3/8"	11	35	14	26	-	24	10	714.112.96	5
NPT 1/2"	1/2"	14,5	36	14	29	-	27	10	714.116.96	5,6
NPT 3/4"	3/4"	19,4	37	14	35	-	33	5	714.120.96	8
NPT 1"	1"	24,7	40	16	45	-	42	5	714.126.96	13,8
NPT 1.1/4"	1.1/4"	33,3	43	16	53	-	50	2	714.135.96	18,8

NPT 90° fitting, compact, male, stainless steel AISI-316  
(incl. metal clamping ring)

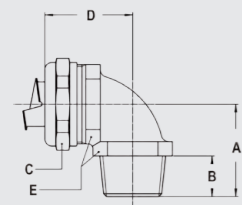

THREAD NPT	SLI-316 SIZE (INCH)	MIN. INTERNAL BORE (MM)	DIMENSIONS IN MM					STANDARD PACKAGE	ARTICLE NUMBER	WEIGHT (KG/100)
			A	B	C	D	E			
NPT 1/2"	3/8"	11	30	14	26	32	24	10	714.512.96	8,8
NPT 1/2"	1/2"	14,5	32	14	29	34	27	10	714.516.96	10,2
NPT 3/4"	3/4"	19,4	36	14	35	40	33	5	714.520.96	17,7
NPT 1"	1"	24,7	44	16	45	49	42	5	714.526.96	29,5
NPT 1.1/4"	1.1/4"	33,3	49	16	53	53	52	2	714.535.96	43,4

# Anaconda Multiflex conduit

## TYPE SLI-CAP



### SMALL DIAMETERS, FLEXIBLE AND VERY CORROSION RESISTANT

Anaconda Multiflex SLI-CAP conduits are typified by their small internal and outer diameters for the mechanical protection of very thin wires and/or cables. SLI-CAP is very flexible and features a stainless steel core AISI 304 with a square lock design. Typical areas of application include the protection of wires and/or cables on sensitive measuring instruments, optical fibres as well as equipment and machines used in the pharmaceutical and bio industries.

#### Material & Construction:

**Construction:** Stainless steel AISI-304 core, square locked. On demand also available in AISI-316.

**Temperature:** -100 °C till +600 °C.

**Colour:** Metal coloured.

#### Classification according NEN-EN-IEC 61386:

**Compression resistance:** Class 3, Medium (750 N).

**Impact resistance:** Class 3, Medium (2 J).

**Tensile strength:** Class 3, Medium (500 N).

**Protection class:** IP 40.



Square locked

SLI-CAP	DIAMETRE		BENDING RADIUS (CL)		SMALL CARTON		STANDARD CARTON		LARGE CARTON		WEIGHT
	Size (dn)	Inside (mm)	Outside (mm)	Static (mm)	Dynamic (mm)	Metre	Article No.	Metre	Article No.	Metre	
3	3,5	5,1	21	30	30	600.003.2	-	-	-	-	0,03
4	4	6	22	32	30	600.004.2	-	-	-	-	0,04
5	4,8	6,8	23	33	30	600.005.2	-	-	-	-	0,05
6	6,4	8,4	40	50	30	600.006.2	-	-	-	-	0,06
7	7,2	9,5	40	50	30	600.007.2	-	-	-	-	0,07
8	8	10,3	45	55	30	600.008.2	-	-	-	-	0,08
9,5	9,8	13	50	65	30	600.009.2	-	-	-	-	0,15

\* On demand also available in longer lengths (article numbers end in .0).

The fittings for Multiflex SLI-CAP are out-lined on pages 1 - 23 till 1 - 26

MULTIFLEX	1/4"	5/16"	3/8"	1/2"	3/4"	1"	1 1/4"	1 1/2"	2"	2 1/2"	3"	4"
ISO	M12 - M16	M16 - M20	M16 - M20	M20	M25	M32	M40	M50	M63	M75	M90	M105
Pg	7	9-11	11 - 13,5	16	21	29	36	42	48	-	-	-
NPT	-	-	1/2"	1/2"	3/4"	1"	1 1/4"	1 1/2"	2"	2 1/2"	3"	4"



# 2 Piece fittings for SLI-CAP, IP 40, nickel plated brass



Anaconda  
Multiflex



## ANAMET NICKEL PLATED BRASS FITTINGS FOR MULTIFLEX SLI-CAP

These nickel plated brass Anamet fittings can be used with Anaconda Multiflex type SLI-CAP. The 2-piece fittings are universal fittings and offer great corrosion protection in combination with a slim appearance. Next to the mentioned straight fittings, custom made solutions are also possible.

### Material & Construction:

**Construction:** Nickel plated brass fitting, consisting of 2 parts (cap and body).

**Material:** Cap and body are nickel plated brass.

**Temperature:** -55 °C till +260 °C continuous.

**Protection class:** IP 40.

**Colour:** Metal coloured.

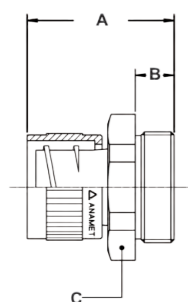

ISO straight fitting, fixed, male, nickel plated brass



THREAD ISO	SLI-CAP DN (MM)	MIN. INTERNAL BORE (MM)	DIMENSIONS IN MM					STANDARD PACKAGE	ARTICLE NUMBER	WEIGHT (KG/100)
			A	B	C	D	E			
M10 x 1,0	7	5,5	24	8	14	-	-	10	256.010.0	1,3
M12 x 1,5	7	5,5	24	8	14	-	-	10	256.011.0	1,4
M12 x 1,5	9,5	8,5	26	10	18	-	-	10	256.012.0	1,8
M16 x 1,5	9,5	8,5	26	10	18	-	-	10	256.015.0	2

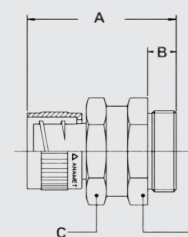

ISO straight fitting, swivel, male, nickel plated brass



THREAD ISO	SLI-CAP DN (MM)	MIN. INTERNAL BORE (MM)	DIMENSIONS IN MM					STANDARD PACKAGE	ARTICLE NUMBER	WEIGHT (KG/100)
			A	B	C	D	E			
M10 x 1,0	7	5,5	30	8	14	-	14	10	256.110.0	1,7
M12 x 1,5	7	5,5	30	8	14	-	14	10	256.111.0	1,9
M12 x 1,5	9,5	8,5	34	10	18	-	18	10	256.112.0	2,4
M16 x 1,5	9,5	8,5	34	10	18	-	18	10	256.115.0	3,1

## 2 PIECE FITTINGS FOR SLI-CAP, IP 40, NICKEL PLATED BRASS



Pg straight fitting, fixed, male, nickel plated brass



THREAD PG	SLI-CAP DN (MM)	MIN. INTERNAL BORE (MM)	DIMENSIONS IN MM					STANDARD PACKAGE	ARTICLE NUMBER	WEIGHT (KG/100)
			A	B	C	D	E			
Pg 7	7	5,5	24	8	14	-	-	10	256.407.0	1,3
Pg 9	9,5	8,5	26	10	18	-	-	10	256.409.0	1,9

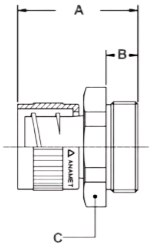

Pg straight fitting, swivel, male, nickel plated brass



THREAD PG	SLI-CAP DN (MM)	MIN. INTERNAL BORE (MM)	DIMENSIONS IN MM					STANDARD PACKAGE	ARTICLE NUMBER	WEIGHT (KG/100)
			A	B	C	D	E			
Pg 7	7	5,5	30	8	14	-	14	10	256.507.0	1,8
Pg 9	9,5	8,5	34	10	18	-	18	10	256.509.0	3

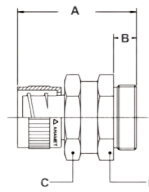

End cap, nickel plated brass



THREAD	SLI-CAP DN (MM)	MIN. INTERNAL BORE (MM)	DIMENSIONS IN MM					STANDARD PACKAGE	ARTICLE NUMBER	WEIGHT (KG/100)
			A	B	C	D	E			
-	7	5,5	18	6	13	-	-	10	264.110.0	0,4
-	9,5	8,5	18	6	17	-	-	10	264.112.0	0,4

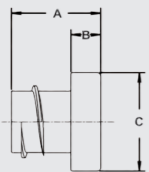

# Compact fittings for SLI-CAP, IP 40, nickel plated brass



Anaconda  
Multiflex



## ANACONDA NICKEL PLATED BRASS FITTINGS FOR MULTIFLEX SLI-CAP

The nickel plated brass Anaconda "small design" fittings for Sealrite illustrated in chapter 5, can be used also in combination with SLI-CAP conduits sizes 6 and 10, by replacing the standard polyamide clamping ring with the metal clamping ring adapters mentioned below. The fittings offer high corrosion protection in combination with a very nice appearance. Thanks to the sharp thread of the turned ferrule a very high pull-out strength is achieved. Next to the mentioned straight fittings, custom made solutions are possible as well. The clamping ring has to be ordered separately.

### Material & Construction:

**Construction:** Nickel plated brass fitting, consisting of 4 parts (counter nut, clamping ring, ferrule and body).

**Temperature:** -55 °C till +260 °C continuous.

**Protection class:** IP 40.

**Colour:** Metal coloured.

**Material:** Counter nut, clamping ring, ferrule and body are nickel plated brass.

Clamping ring, nickel plated brass, for combination with Multiflex type SLI-CAP



THREAD ISO	SLI-CAP DN (MM)	MIN. INTERNAL BORE (MM)	FITTING THREAD SIZE			STANDARD PACKAGE	ARTICLE NUMBER	WEIGHT (KG/100)
			ISO	Pg	NPT			
-	6	-	M12 x 1,5	Pg 7	-	10	817.206.6	0,4
-	6	-	M16 x 1,5	-	-	10	817.206.6	0,4
-	9,5	-	M12 x 1,5	Pg 9	-	10	817.209.6	0,6
-	9,5	-	M16 x 1,5	-	-	10	817.209.6	0,6
-	9,5	-	M20 x 1,5	-	-	10	817.209.6	0,6

ISO straight fitting, small design, male, nickel plated brass (excluding clamping ring)

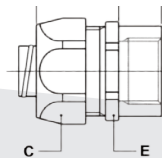

THREAD ISO	SLI-CAP DN (MM)	MIN. INTERNAL BORE (MM)	DIMENSIONS IN MM					STANDARD PACKAGE	ARTICLE NUMBER	WEIGHT (KG/100)
			A	B	C	D	E			
M12 x 1,5	6	5,2	33	10	19	-	17	10	812.012.2	2,8
M16 x 1,5	6	5,2	35	12	19	-	19	10	812.013.2	3,4
M12 x 1,5	9,5	8,3	33	10	22	-	20	10	812.011.2	3,6
M16 x 1,5	9,5	8,3	35	12	22	-	20	10	812.015.2	3,8
M20 x 1,5	9,5	8,3	36	13	22	-	24	10	812.014.2	4,2

Pg straight fitting, small design, male, nickel plated brass (excluding clamping ring)

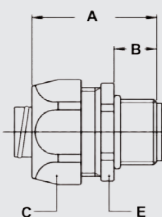

THREAD PG	SLI-CAP DN (MM)	MIN. INTERNAL BORE (MM)	DIMENSIONS IN MM					STANDARD PACKAGE	ARTICLE NUMBER	WEIGHT (KG/100)
			A	B	C	D	E			
Pg 7	6	5,2	33	10	19	-	17	10	810.007.2	2,8
Pg 9	9,5	8,3	35	12	22	-	20	10	810.009.2	3,8

# Compact fittings for SLI-CAP, IP 40, nickel plated brass



## ANACONDA COMPACT NICKEL PLATED BRASS FITTINGS FOR MULTIFLEX SLI-CAP

A special cable-hose fitting in nickel plated brass has been developed for SLI-CAP conduits. These special compact fittings are amongst other applications used in combination with SLI-CAP and proximity switch adapters in order to guarantee an IP 68 sealing at the switchbox. By using the special SLI-CAP clamping ring, a very high pull-out strength is achieved. Next to the mentioned straight fittings, custom made solutions are also possible. The clamping ring must be ordered separately.

### Material & Construction:

**Construction:** Nickel plated brass fitting, consisting of 6 parts (counter nut, clamping ring, ferrule, intermediate part, sealing ring and body).

**Material:** Counter nut, clamping ring, ferrule, intermediate part and body are nickel plated brass. O-rings are from NBR and the sealing ring is made from EPDM rubber.

**Temperature:** -55 °C till +125 °C continuous.

**Protection class:** IP 40 on the conduit and IP 68 on the switchbox.

**Colour:** Metal coloured.



Clamping ring, nickel plated brass, for combination with Multiflex type SLI-CAP



THREAD ISO	SLI-CAP DN (MM)	MIN. INTERNAL BORE (MM)	FITTING THREAD SIZE			STANDARD PACKAGE	ARTICLE NUMBER	WEIGHT (KG/100)
			ISO	Pg	NPT			
-	6	-	M12 x 1,5	-	-	10	817.206.6	0,4
-	6	-	M16 x 1,5	-	-	10	817.206.6	0,4
-	9,5	-	M16 x 1,5	-	-	10	817.209.6	0,6
-	9,5	-	M20 x 1,5	-	-	10	817.209.6	0,6



ISO cable-hose fitting, compact, male, nickel plated brass (excl. clamping ring)

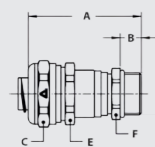

THREAD ISO	SLI-CAP DN (MM)	CLAMPING RANGE (MM)	DIMENSIONS IN MM					STANDARD PACKAGE	ARTICLE NUMBER	WEIGHT (KG/100)
			A	B	C	E	F			
M12 x 1,5	6	1,0 - 5,2	46	9	19	17	14	10	712.712.26	4
M16 x 1,5	6	1,0 - 5,2	47	10	19	17	18	10	712.713.26	4,7
M16 x 1,5	9,5	4,0 - 8,3	50	10	22	20	18	10	712.715.26	5,7
M20 x 1,5	9,5	4,0 - 8,3	50	10	22	20	22	10	712.714.26	6,4



# Anaconda Multiflex conduit

## TYPE SLB



Anaconda  
Multiflex

### FLEXIBLE AND ROBUST, WITH STAINLESS STEEL BRAID

SLB is a very flexible conduit comprising a galvanized steel core with a robust stainless steel AISI-304 overbraid. Designed to provide mechanical and EMC protection in critical applications. This robust, stainless steel braid cover provides a high level of electromagnetic shielding for cables. Typical applications include the steel, foundry, metalworking and other demanding heavy duty industries.

#### Material & Construction:

**Construction:** Galvanised steel core, square locked with stainless steel (AISI-304) braid.

**Temperature:** -55 °C till +300 °C.

**Colour:** Metal coloured.

#### Classification according NEN-EN-IEC 61386:

**Compression resistance:** Class 4, Heavy (1250 N).

**Impact resistance:** Class 4, Heavy (6 J).

**Tensile strength:** Class 4, Heavy (1000 N).

**Protection class:** IP 40.



Square locked

SLB	DIAMETRE		BENDING RADIUS (CL)		SMALL CARTON		STANDARD CARTON		LARGE CARTON		WEIGHT (kg/m)
	Size Inch	Inside (mm)	Outside (mm)	Static (mm)	Dynamic (mm)	Metre	Article No.	Metre	Article No.	Metre	
5/16"	10,1	13,5	37	50	30	107.710.2	-	-	-	-	0,16
3/8"	12,6	15,8	45	60	30	107.712.2	-	-	-	-	0,2
1/2"	16	20,5	55	80	30	107.716.2	-	-	-	-	0,25
3/4"	21	25,5	70	100	30	107.720.2	-	-	-	-	0,34
1"	26,5	32,8	95	125	30	107.726.2	-	-	-	-	0,64
1 1/4"	35,1	40,5	115	160	30	107.735.2	-	-	-	-	0,94
1 1/2"	40,3	46,5	165	250	15	107.740.2	-	-	-	-	1,22
2"	51,6	58	210	300	15	107.750.2	-	-	-	-	1,81

The fittings for SLB are outlined on page 1 - 28

MULTIFLEX	1/4"	5/16"	3/8"	1/2"	3/4"	1"	1 1/4"	1 1/2"	2"	2 1/2"	3"	4"
ISO	M12 - M16	M16 - M20	M16 - M20	M20	M25	M32	M40	M50	M63	M75	M90	M105
Pg	7	9 - 11	11 - 13,5	16	21	29	36	42	48	-	-	-
NPT	-	-	1/2"	1/2"	3/4"	1"	1 1/4"	1 1/2"	2"	2 1/2"	3"	4"

# Compact fittings for SLB, IP 40, nickel plated brass



## ANACONDA COMPACT, NICKEL PLATED BRASS, FITTINGS FOR MULTIFLEX SLB

All nickel plated brass (as well as stainless steel) Anaconda compact fittings for Sealtite conduits illustrated in chapter 5, can be used also in combination with SLB conduits by replacing the standard polyamide clamping ring with metal clamping ring adapters mentioned below. This clamping ring has to be ordered separately.

### Material & Construction:

**Construction:** Nickel plated brass fitting, consisting of 4 parts (counter nut, clamping ring, ferrule and body).

**Material:** Counter nut and body are nickel plated brass. The clamping ring is from zinc plated brass. The ferrule is from galvanised steel. O-rings are from NBR (black for ISO metric and blue for Pg).

**Temperature:** -55 °C till +260 °C continuous.

**Protection class:** IP 40. Cable-hose fittings are IP 68 on the switchbox.

**Colour:** Metal coloured.



Clamping ring, zinc plated brass, for combination with Multiflex type SLB



THREAD	SLB SIZE (INCH)	MIN. INTERNAL BORE (MM)	FITTING THREAD SIZE			STANDARD PACKAGE	ARTICLE NUMBER	WEIGHT (KG/100)
			ISO	Pg	NPT			
-	5/16"	-	M16 x 1,5	Pg 11	1/2" NPT	10	817.710.0	0,6
-	3/8"	-	M16 x 1,5	Pg 11	1/2" NPT	10	817.712.0	0,6
-	1/2"	-	M20 x 1,5	Pg 16	1/2" NPT	10	817.716.0	0,6
-	3/4"	-	M25 x 1,5	Pg 21	3/4" NPT	5	817.720.0	1
-	1"	-	M32 x 1,5	Pg 29	1" NPT	5	817.726.0	1,2
-	1.1/4"	-	M40 x 1,5	Pg 36	1.1/4" NPT	2	817.735.0	2
-	1.1/2"	-	M50 x 1,5	Pg 42	1.1/2" NPT	2	817.740.0	4,2
-	2"	-	M63 x 1,5	Pg 48	2" NPT	2	817.750.0	9

The above mentioned clamping rings for SLB can be used with all types of compact fittings, as outlined in chapter 5.

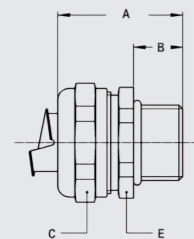

ISO straight compact fitting, male, nickel plated brass (without clampingring)



THREAD ISO	SLB SIZE (INCH)	MIN. INTERNAL BORE (MM)	DIMENSIONS IN MM					STANDARD PACKAGE	ARTICLE NUMBER	WEIGHT (KG/100)
			A	B	C	D	E			
M16 x 1,5	5/16"	8,3	31	10	26	-	24	10	712.015.0	4,5
M20 x 1,5	5/16"	8,3	31	10	26	-	24	10	712.014.0	4,6
M16 x 1,5	3/8"	11	31	10	26	-	24	10	712.016.1	4,5
M20 x 1,5	3/8"	11	31	10	26	-	24	10	712.017.1	4,6
M20 x 1,5	1/2"	14,5	32	10	29	-	27	10	712.020.1	5
M25 x 1,5	3/4"	19,4	33	10	35	-	33	5	712.025.1	7,6
M32 x 1,5	1"	24,7	36	12	45	-	42	5	712.032.1	12,9
M40 x 1,5	1.1/4"	33,3	40	13	53	-	50	2	712.040.1	18
M50 x 1,5	1.1/2"	38	46	14	62	-	58	2	712.050.1	29,5
M63 x 1,5	2"	49	52	16	76	-	72	2	712.063.1	47,6

# Anaconda Multiflex conduit

## TYPE UIG



Anaconda  
Multiflex

### VERY ROBUST AND EXTREMELY FLEXIBLE

Anaconda Multiflex type UIG is a flexible, fully interlocked, galvanized steel conduit that has excellent tensile, torsional and crush strength. It is an excellent choice in demanding applications requiring a high degree of mechanical and thermal protection against hot metal swarf and chips and other potentially damaging materials. Typical applications include: robots in steel and automotive plants, foundries, die casting and metalworking machines.

#### Material & Construction:

**Construction:** Galvanised steel core, fully inter locked.

**Temperature:** -55 °C till +300 °C.

**Colour:** Metal coloured.

#### Classification according NEN-EN-IEC 61386:

**Compression resistance:** Class 5, Very Heavy (4000 N).

**Impact resistance:** Class 4, Heavy (6 J).

**Tensile strength:** Class 4, Heavy (1000 N).

**Protection class:** IP 40.



UIG	DIAMETRE		BENDING RADIUS (CL)		STANDARD CARTON		SMALL CARTON		REEL		WEIGHT (kg/m)
	Size (inch)	Inside (mm)	Outside (mm)	Static (mm)	Dynamic (mm)	Metre	Article No.	Metre	Article No.	Metre	
5/16"	9,5	12,5	50	60	30	515.010.0	-	-	-	-	0,12
3/8"	13	16	65	80	30	515.012.0	-	-	-	-	0,2
1/2"	17	21	75	100	30	515.016.0	-	-	-	-	0,3
3/4"	22	26	90	125	30	515.022.0	-	-	-	-	0,4
1"	26	30	120	160	30	515.025.0	-	-	-	-	0,47
1 1/4"	34	39	175	220	30	515.034.0	-	-	-	-	0,67
1 1/2"	40,3	44,4	230	280	15	515.040.0	-	-	-	-	0,73
2"	51,6	55,7	285	340	15	515.050.0	-	-	-	-	1,6
2 1/2"	63,3	67,4	350	400	7,5	515.063.0	-	-	-	-	1,9
3"	78,4	84,2	430	600	7,5	515.075.0	-	-	-	-	2,4
4"	102,1	108	490	700	7,5	515.099.0	-	-	-	-	3,1

\* On demand the UIG conduit in the sizes 1 1/2" and 2" can be ordered in production reels having variable lengths, in this case the codes change as following: 1 1/2" = 109.040.0 and 2" = 109.050.0.

The fittings for Multiflex UIG are outlined on pages 1 - 31 till 1 - 39

UIG	-	5/16"	3/8"	1/2"	3/4"	1"	1 1/4"	1 1/2"	2"	2 1/2"	3"	4"
ISO	-	M16 - M20	M16 - M20	M20	M25	M32	M40	M50	M63	-	-	-
PG	-	09 - 11	11 - 13,5	16	21	29	36	42	48	-	-	-
NPT	-	-	1/2"	1/2"	3/4"	1"	1 1/4"	1 1/2"	2"	2 1/2"	3"	4"

# Anaconda Multiflex conduit

## TYPE UI



### VERY ROBUST, EXTREMELY FLEXIBLE AND CORROSION RESISTANT

Anaconda Multiflex type UI is the stainless steel version of type UIG. Extremely flexible and robust, this fully interlocked, stainless steel AISI-304 in addition to having excellent tensile, torsional and crush strength, it is also high corrosion and oxidation resistant. It is an optimal choice for protection of cables in dynamic motions. Typical applications include: robots in steel and automotive plants, foundries, die casting and metalworking machines, closed circuit TV (CCTV) security recording systems and video cameras, passenger information systems, door locking systems and rail sector.

#### Material & Construction:

- Construction:** Stainless steel core (AISI-304), fully inter locked.
- BS 6853 (1999):  
Tabel 7 (Interior): Category 1a, 1b and II vehicle.  
Tabel 8 (Exterior): Category 1a, 1b and II vehicle.
  - London Underground LUL 1-085 (2011):  
Tabel 3: Extensive and grouped usage.  
Tabel 4: Limited and dispersed usage.
  - EN 45545-2 (2013):  
R22 (interior equipment): class HL1, HL2 and HL3.  
R23 (exterior equipment): class HL1, HL2 and HL3.
- Temperature:** -100 °C till +600 °C.  
**Colour:** Metal coloured.

#### Classification according to NEN-EN-IEC 61386:

- Compression resistance:** Class 5, Very Heavy (4000 N).  
**Impact resistance:** Class 4, Heavy (6 J).  
**Tensile strength:** Class 4, Heavy (1000 N).  
**Protection class:** IP 40.

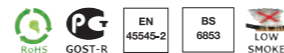

UI	DIAMETRE		BENDING RADIUS (CL)		STANDARD CARTON		SMALL CARTON		REEL		WEIGHT (kg/m)
	Size (inch)	Inside (mm)	Outside (mm)	Static (mm)	Dynamic (mm)	Metre	Article No.	Metre	Article No.	Metre	
5/16"	9,5	12,5	50	60	30	512.010.0	-	-	-	-	0,17
3/8"	13	16	65	80	30	512.012.0	-	-	-	-	0,27
1/2"	17	21	75	100	30	512.016.0	-	-	-	-	0,34
3/4"	22	26	90	125	30	512.022.0	-	-	-	-	0,37
1"	26	30	120	160	30	512.025.0	-	-	-	-	0,53
1 1/4"	34	39	175	220	30	512.034.0	-	-	-	-	0,73
1 1/2"	40,3	44,4	230	280	15	512.040.0	-	-	-	-	0,87
2"	51,6	55,7	285	340	15	512.050.0	-	-	-	-	1,34

The fittings for Multiflex UI are outlined on pages 1 - 31 till 1 - 41

UI	-	5/16"	3/8"	1/2"	3/4"	1"	1 1/4"	1 1/2"	2"
ISO	-	M16 - M20	M16 - M20	M20	M25	M32	M40	M50	M63
PG	-	09 - 11	11 - 13,5	16	21	29	36	42	48
NPT	-	-	1/2"	1/2"	3/4"	1"	1 1/4"	1 1/2"	2"



# Compact fittings for UI / UIG, IP 40, nickel plated brass



Anaconda  
Multiflex



## ANACONDA COMPACT FITTINGS, IP 40, NICKEL PLATED BRASS FOR MULTIFLEX UI AND UIG

These Anaconda compact nickel plated brass fittings are the same as used in chapter 5 (compact Sealtite). By replacing the standard polyamide clamping ring and stamped metal ferrule with a metal clamping ring and machine turned ferrule (see connection sets below) they suitable to be used in combination with UIG and UI conduits. By using the UIG / UI connection sets, a very high pull-out strength is achieved. The high quality finish of these nickel plated brass fittings gives them a good protection against corrosion and a nice appearance.

### Material & Construction:

**Construction:** Nickel plated brass fitting, consisting of 4 parts (counter nut, clamping ring, ferrule and body). The clamping rubbers of the cable-hose fittings are made from EPDM.

**Special approvals:** The cable-hose fittings have clamping rubbers from flame retardant VO-rated EPDM and are HL1, HL2 and HL3 according EN 45545-2, R22 and R23.

**Temperature:** -55 °C till +260 °C continuous. Cable-hose fittings are from -55 °C till +125 °C continuous.

**Protection class:** IP 40. Cable-hose fittings are IP 68 on the switchbox.

**Colour:** Metal coloured.

Connection set, nickel plated brass, for combination with Multiflex type UI / UIG



THREAD	UIG/UI SIZE (INCH)	MIN. INTERNAL BORE (MM)	FITTING THREAD SIZE			STANDARD PACKAGE	ARTICLE NUMBER	WEIGHT (KG/100)
			ISO	Pg	NPT			
-	5/16"	6,8	M16 x 1,5	Pg 11	1/2" NPT	10	817.210.9	2,2
-	3/8"	9,8	M16 x 1,5	Pg 11	1/2" NPT	10	817.213.9	2
-	1/2"	13,9	M20 x 1,5	Pg 16	1/2" NPT	10	817.216.9	2,4
-	3/4"	18,5	M25 x 1,5	Pg 21	3/4" NPT	5	817.220.9	3,8
-	1"	22,8	M32 x 1,5	Pg 29	1" NPT	5	817.226.9	4
-	1.1/4"	30,8	M40 x 1,5	Pg 36	1.1/4" NPT	2	817.235.9	9,8
-	1.1/2"	36,9	M50 x 1,5	Pg 42	1.1/2" NPT	2	817.240.9	12,4
-	2"	47,9	M63 x 1,5	Pg 48	2" NPT	2	817.250.9	18,2
-	2.1/2"	-	M75 x 1,5	-	2.1/2" NPT	1	817.263.6*	14
-	3"	-	M90 x 2,0	-	3" NPT	1	817.275.6*	20

\* Set consists of a clamping ring only, because the standard ferrules of the compact fittings for sizes 2.1/2" till 3" can be used also for UIG conduit 2.1/2" till 3".

The above mentioned clamping rings for UIG and UI can be used with all types of compact fittings, as outlined in chapter 5.

## COMPACT FITTINGS FOR UI / UIG, IP 40, NICKEL PLATED BRASS

ISO straight compact fitting, male, nickel plated brass  
(including connection set)

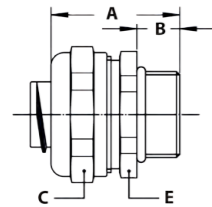

THREAD ISO	UIG / UI SIZE (INCH)	MIN. INTERNAL BORE (MM)	DIMENSIONS IN MM					STANDARD PACKAGE	ARTICLE NUMBER	WEIGHT (KG/100)
			A	B	C	D	E			
M16 x 1,5	5/16"	6,8	31	10	26	-	24	10	712.015.7	6,1
M20 x 1,5	5/16"	6,8	31	10	26	-	24	10	712.014.7	6,2
M16 x 1,5	3/8"	9,8	31	10	26	-	24	10	712.016.7	5,9
M20 x 1,5	3/8"	9,8	31	10	26	-	24	10	712.017.7	6
M20 x 1,5	1/2"	13,9	32	10	29	-	27	10	712.020.7	6,8
M25 x 1,5	3/4"	18,5	33	10	35	-	33	5	712.025.7	10,4
M32 x 1,5	1"	22,8	36	12	45	-	44	5	712.032.7	15,7
M40 x 1,5	1.1/4"	30,8	40	13	53	-	50	2	712.040.7	25,8
M50 x 1,5	1.1/2"	36,9	46	14	62	-	58	2	712.050.7	37,7
M63 x 1,5	2"	47,9	52	16	76	-	72	2	712.063.7	56,8
M75 x 1,5	2.1/2"	60,7	62	20	90	-	85	1	712.075.7	88,8
M90 x 2,0	3"	75,5	70	24	108	-	102	1	712.090.7	127

ISO cable-hose fitting, compact, male, double seal acc. EN 45545-2,  
HL1 / HL2 / HL3, table R22 and R23 (incl. connection set)

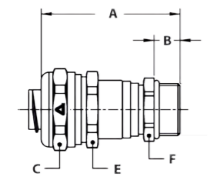

THREAD ISO	UIG / UI SIZE (INCH)	CLAMPING RANGE (MM)	DIMENSIONS IN MM					STANDARD PACKAGE	ARTICLE NUMBER	WEIGHT (KG/100)
			A	B	C	E	F			
M16 x 1,5	5/16"	4,0 - 6,8	50	10	26	24	18	10	712.715.7	9
M20 x 1,5	5/16"	4,0 - 6,8	50	10	26	24	22	10	712.714.7	9,6
M16 x 1,5	3/8"	4,0 - 9,5	50	10	26	24	18	10	712.716.7	8,8
M20 x 1,5	3/8"	4,0 - 9,5	50	10	26	24	22	10	712.717.7	9,4
M20 x 1,5	1/2"	6,0 - 13,0	53	10	29	27	22	10	712.720.7	10
M25 x 1,5	1/2"	6,0 - 13,0	54	10	29	27	27	5	712.722.7	11,4
M25 x 1,5	3/4"	11,0 - 18,0	56	10	35	33	27	5	712.725.7	15,5
M32 x 1,5	3/4"	11,0 - 18,0	58	12	35	33	35	5	712.728.7	18,8
M32 x 1,5	1"	16,0 - 22,5	61	12	45	42	35	5	712.732.7	24,3
M40 x 1,5	1"	16,0 - 22,5	63	13	45	42	43	2	712.735.7	28,5
M40 x 1,5	1.1/4"	22,0 - 30,8	69	13	53	50	43	2	712.740.7	38,4

ISO straight swivel fitting, male, nickel plated brass (incl. connection set)

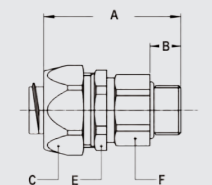

THREAD ISO	UIG / UI SIZE (INCH)	MIN. INTERNAL BORE (MM)	DIMENSIONS IN MM					STANDARD PACKAGE	ARTICLE NUMBER	WEIGHT (KG/100)
			A	B	C	E	F			
M16 x 1,5	5/16"	6,8	48	10	26	24	21	10	813.015.7	10,3
M16 x 1,5	3/8"	9,8	48	10	26	24	21	10	813.016.7	10,1
M20 x 1,5	1/2"	13,9	49	10	29	27	25	10	813.020.7	12,6
M25 x 1,5	3/4"	17,4	49	10	35	33	31	5	813.025.7	17,6
M32 x 1,5	1"	22,8	55	12	45	42	38	5	813.032.7	36,5
M40 x 1,5	1.1/4"	29,4	58	14	54	50	48	2	813.040.7	62,8
M50 x 1,5	1.1/2"	36,9	65	14	62	58	55	2	813.050.7	78,2
M63 x 1,5	2"	47,9	74	16	76	72	68	2	813.063.7	139

## COMPACT FITTINGS FOR UI / UIG, IP 40, NICKEL PLATED BRASS

ISO 90° fitting, compact, male, nickel plated brass  
(including connection set)

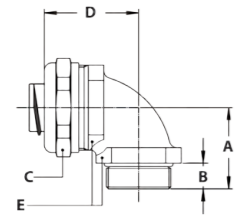

THREAD ISO	UIG/UI SIZE (INCH)	MIN. INTERNAL BORE (MM)	DIMENSIONS IN MM					STANDARD PACKAGE	ARTICLE NUMBER	WEIGHT (KG/100)
			A	B	C	D	E			
M16 x 1,5	5/16"	6,8	26	10	26	31	22	10	712.915.7	8,8
M20 x 1,5	5/16"	6,8	26	10	26	32	24	10	712.914.7	10,1
M16 x 1,5	3/8"	9,8	26	10	26	31	22	10	712.916.7	8,6
M20 x 1,5	3/8"	9,8	26	10	26	32	24	10	712.917.7	9,9
M20 x 1,5	1/2"	13,9	28	10	29	34	27	10	712.920.7	11,6
M25 x 1,5	3/4"	18,5	32	10	35	40	33	5	712.925.7	20
M32 x 1,5	1"	22,8	40	12	45	49	42	5	712.932.7	31,8
M40 x 1,5	1.1/4"	30,8	46	13	53	53	52	2	712.940.7	49,9
M50 x 1,5	1.1/2"	36,9	52	14	62	57	60	2	712.950.7	69,9
M63 x 1,5	2"	47,9	62	16	76	68	72	2	712.963.7	108,8

ISO 90° swivel fitting, compact, male, nickel plated brass  
(incl. connection set)

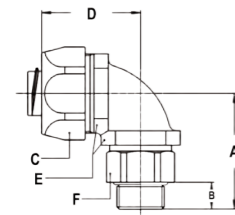

THREAD ISO	UIG/UI SIZE (INCH)	MIN. INTERNAL BORE (MM)	DIMENSIONS IN MM						STANDARD PACKAGE	ARTICLE NUMBER	WEIGHT (KG/100)
			A	B	C	D	E	F			
M16 x 1,5	5/16"	6,8	39	10	26	35	22	21	10	813.915.7	13
M16 x 1,5	3/8"	9,8	39	10	26	35	22	21	10	813.916.7	12,8
M20 x 1,5	1/2"	13,9	39	10	29	37	27	25	10	813.920.7	15,6
M25 x 1,5	3/4"	17,4	46	10	35	44	33	31	5	813.925.7	26,6
M32 x 1,5	1"	22,8	55	12	45	55	42	38	5	813.932.7	45,4

Pg straight compact fitting, male, nickel plated brass (incl. connection set)

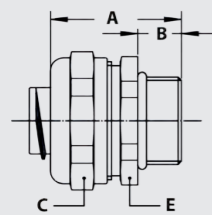

THREAD PG	UIG/UI SIZE (INCH)	MIN. INTERNAL BORE (MM)	DIMENSIONS IN MM					STANDARD PACKAGE	ARTICLE NUMBER	WEIGHT (KG/100)
			A	B	C	D	E			
Pg 11	3/8"	9,8	31	10	26	-	24	10	710.011.7	6
Pg 13,5	3/8"	9,8	31	10	26	-	24	10	710.013.7	6,2
Pg 16	1/2"	13,9	32	10	29	-	27	10	710.016.7	6,9
Pg 21	3/4"	18,5	33	10	35	-	33	5	710.021.7	10,3
Pg 29	1"	22,8	36	12	45	-	44	5	710.029.7	16,2
Pg 36	1.1/4"	30,8	40	13	53	-	52	2	710.036.7	26,2
Pg 42	1.1/2"	36,9	46	14	62	-	60	2	710.042.7	38,7
Pg 48	2"	47,9	52	16	76	-	72	2	710.048.7	56,8

## COMPACT FITTINGS FOR UI / UIG, IP 40, NICKEL PLATED BRASS

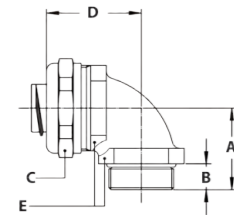

Pg 90° fitting, compact, male, nickel plated brass (incl. connection set)



THREAD PG	UIG/UI SIZE (INCH)	MIN. INTERNAL BORE (MM)	DIMENSIONS IN MM					STANDARD PACKAGE	ARTICLE NUMBER	WEIGHT (KG/100)
			A	B	C	D	E			
Pg 11	3/8"	9,8	26	10	26	32	24	10	710.911.7	9,7
Pg 13,5	3/8"	9,8	26	10	26	32	24	10	710.913.7	10
Pg 16	1/2"	13,9	28	10	29	34	27	10	710.916.7	11,6
Pg 21	3/4"	18,5	32	10	35	40	33	5	710.921.7	19,5
Pg 29	1"	22,8	40	12	45	49	42	5	710.929.7	32,6
Pg 36	1.1/4"	30,8	46	13	53	53	52	2	710.936.7	49,9
Pg 42	1.1/2"	36,9	52	14	62	57	60	2	710.942.7	69,9
Pg 48	2"	47,9	62	16	76	68	72	2	710.948.7	110,3

NPT straight compact fitting, male, nickel plated brass (incl. connection set)

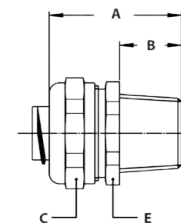

THREAD NPT	UIG/UI SIZE (INCH)	MIN. INTERNAL BORE (MM)	DIMENSIONS IN MM					STANDARD PACKAGE	ARTICLE NUMBER	WEIGHT (KG/100)
			A	B	C	D	E			
NPT 1/2"	3/8"	9,8	35	14	26	-	24	10	714.012.7	6,4
NPT 1/2"	1/2"	13,9	36	14	29	-	27	10	714.016.7	7,4
NPT 3/4"	3/4"	18,5	37	14	35	-	33	5	714.020.7	10,8
NPT 1"	1"	22,8	40	16	45	-	42	5	714.026.7	16,6
NPT 1.1/4"	1.1/4"	30,8	43	16	53	-	50	2	714.035.7	26,6
NPT 1.1/2"	1.1/2"	36,9	50	18	62	-	58	2	714.040.7	38,2
NPT 2"	2"	47,9	56	20	76	-	72	2	714.050.7	59,4
NPT 2.1/2"	2.1/2"	60,7	67	25	90	-	85	1	714.063.7	97,6
NPT 3"	3"	75,5	73	27	108	-	102	1	714.075.7	133

NPT 90° fitting, compact, male, nickel plated brass (incl. connection set)

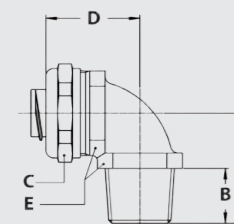

THREAD NPT	UIG/UI SIZE (INCH)	MIN. INTERNAL BORE (MM)	DIMENSIONS IN MM					STANDARD PACKAGE	ARTICLE NUMBER	WEIGHT (KG/100)
			A	B	C	D	E			
NPT 1/2"	3/8"	9,8	30	14	26	32	24	10	714.912.7	10,2
NPT 1/2"	1/2"	13,9	32	14	29	34	27	10	714.916.7	12
NPT 3/4"	3/4"	18,5	36	14	35	40	33	5	714.920.7	20,5
NPT 1"	1"	22,8	44	16	45	49	42	5	714.926.7	32,3
NPT 1.1/4"	1.1/4"	30,8	49	16	53	53	52	2	714.935.7	51,2
NPT 1.1/2"	1.1/2"	36,9	56	18	62	57	60	2	714.940.7	71,5
NPT 2"	2"	47,9	66	20	76	68	72	2	714.950.7	109
NPT 2.1/2"	2.1/2"	60,7	80	25	90	87	85	1	714.963.7	212
NPT 3"	3"	75,5	92	27	108	97	102	1	714.975.7	309



COMPACT FITTINGS FOR UI / UIG, IP 40, NICKEL PLATED BRASS

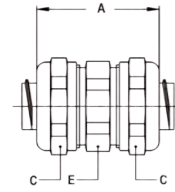

Conduit connector, nickel plated brass (incl. connection set)



UI / UIG SIZE (INCH)	UIG/UI SIZE (INCH)	MIN. INTERNAL BORE (MM)	DIMENSIONS IN MM					STANDARD PACKAGE	ARTICLE NUMBER	WEIGHT (KG/100)
			A	B	C	D	E			
5/16"	5/16"	6,8	41	-	26	-	24	10	784.010.7	11,8
3/8"	3/8"	9,8	41	-	26	-	24	10	784.012.7	11,4
1/2"	1/2"	13,9	45	-	29	-	27	10	784.016.7	13,6
3/4"	3/4"	18,5	48	-	35	-	33	5	784.020.7	20,6
1"	1"	22,8	53	-	45	-	44	5	784.026.7	33,2
1.1/4"	1.1/4"	30,8	58	-	53	-	50	2	784.035.7	52,2
1.1/2"	1.1/2"	36,9	69	-	62	-	58	2	784.040.7	60,8
2"	2"	47,9	78	-	76	-	72	2	784.050.7	94,3

# Fittings for UI / UIG, IP 40, nickel plated brass



## ANACONDA STANDARD FITTINGS, IP 40, NICKEL PLATED BRASS FOR MULTITITE UI AND UIG

These Anaconda standard nickel plated brass fittings are the same as used in chapter 5 (standard Sealtite). By replacing the standard polyamide clamping ring and the ferrule with a metal clamping ring and machine turned ferrule (see connection sets below) they are suitable to be used in combination with UIG and UI conduits. By using the UIG / UI connection sets, a very high pull-out strength is achieved. The high quality finish of these nickel plated brass fittings gives them a good protection against corrosion and a nice appearance.

### Material & Construction:

**Construction:** Nickel plated brass fitting, consisting of 4 parts (counter nut, clamping ring, ferrule and body).

**Material:** Counter nut, clamping ring, ferrule and body are nickel plated brass. Inserts are from PA6 (red for ISO metric, blue for Pg and white for NPT).

**Temperature:** -55 °C till +260 °C continuous (for cable-hose fittings with NBR seal -40 °C till +100 °C).

**Protection class:** IP 40. Cable-hose fittings are IP 68 on the switchbox.

**Colour:** Metal coloured.



Connection set, nickel plated brass, for combination with Multiflex type UI and UIG



THREAD	UIG/UI SIZE (INCH)	MIN. INTERNAL BORE (MM)	FITTING THREAD SIZE			WEIGHT (KG/100)	ARTICLE NUMBER	WEIGHT (KG/100)
			ISO	Pg	NPT			
-	5/16"	6,8	M16 x 1,5	Pg 11	1/2" NPT	10	817.210.9	2,2
-	3/8"	9,8	M16 x 1,5	Pg 11	1/2" NPT	10	817.213.9	2
-	1/2"	13,9	M20 x 1,5	Pg 16	1/2" NPT	10	817.216.9	2,4
-	3/4"	18,5	M25 x 1,5	Pg 21	3/4" NPT	5	817.220.9	3,8
-	1"	22,8	M32 x 1,5	Pg 29	1" NPT	5	817.226.9	4
-	1.1/4"	30,8	M40 x 1,5	Pg 36	1.1/4" NPT	2	817.235.9	9,8
-	1.1/2"	36,8	M50 x 1,5	Pg 42	1.1/2" NPT	2	817.240.9	12,4
-	2"	47,8	M63 x 1,5	Pg 48	2" NPT	2	817.250.9	18,2

The above mentioned connection sets for UIG and UI can be used with all types of standard fittings, as outlined in chapter 5.

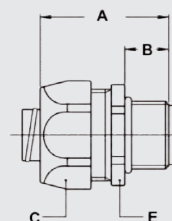

ISO straight fitting, male, nickel plated brass (including connection set)



THREAD ISO	UIG/UI SIZE (INCH)	MIN. INTERNAL BORE (MM)	DIMENSIONS IN MM					STANDARD PACKAGE	ARTICLE NUMBER	WEIGHT (KG/100)
			A	B	C	D	E			
M16 x 1,5	5/16"	6,8	35	12	26	-	24	10	812.015.7	6,2
M20 x 1,5	5/16"	6,8	36	13	26	-	24	10	812.014.7	6,5
M16 x 1,5	3/8"	9,8	35	12	26	-	24	10	812.016.7	6,4
M20 x 1,5	3/8"	9,8	36	13	26	-	24	10	812.017.7	6,7
M20 x 1,5	1/2"	13,9	37	13	29	-	27	10	812.020.7	7,7
M25 x 1,5	3/4"	18,5	40	15	35	-	33	5	812.025.7	10,9
M32 x 1,5	1"	22,8	46	15	45	-	43	5	812.032.7	20,1
M40 x 1,5	1.1/4"	30,8	52	16	54	-	52	2	812.040.7	31,7
M50 x 1,5	1.1/2"	36,8	56	18	63	-	60	2	812.050.7	47,9
M63 x 1,5	2"	47,8	66	20	77	-	74	2	812.063.7	82,9

## FITTINGS FOR UI / UIG, IP 40, NICKEL PLATED BRASS

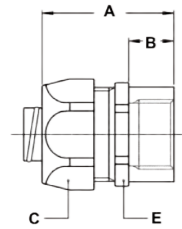

ISO straight fitting, female, nickel plated brass (including connection set)



THREAD ISO	UIG/UI SIZE (INCH)	MIN. INTERNAL BORE (MM)	DIMENSIONS IN MM					STANDARD PACKAGE	ARTICLE NUMBER	WEIGHT (KG/100)
			A	B	C	D	E			
M16 x 1,5	5/16"	6,8	35	12	26	-	24	10	812.315.7	6,4
M16 x 1,5	3/8"	9,8	35	12	26	-	24	10	812.316.7	6,6
M20 x 1,5	1/2"	13,9	37	13	29	-	27	10	812.320.7	9,4
M25 x 1,5	3/4"	18,5	40	15	35	-	33	5	812.325.7	12
M32 x 1,5	1"	22,8	46	15	45	-	43	5	812.332.7	20,9
M40 x 1,5	1.1/4"	30,8	52	16	54	-	52	2	812.340.7	33,1
M50 x 1,5	1.1/2"	36,8	56	18	63	-	60	2	812.350.7	46,8
M63 x 1,5	2"	47,8	66	20	77	-	74	2	812.363.7	81,2

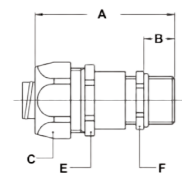

ISO cable-hose fitting, male, nickel plated brass (including connection set)



THREAD ISO	UIG/UI SIZE (INCH)	CLAMPING RANGE (MM)	DIMENSIONS IN MM					STANDARD PACKAGE	ARTICLE NUMBER	WEIGHT (KG/100)
			A	B	C	E	F			
M16 x 1,5	5/16"	3 - 6,8	64	12	26	24	20	10	812.715.27	10,4
M16 x 1,5	3/8"	3 - 9,8	64	12	26	24	20	10	812.716.7	10,2
M20 x 1,5	3/8"	6 - 9,8	57	12	26	24	22	10	812.717.7	11,9
M20 x 1,5	1/2"	7 - 13,9	64	12	29	27	24	10	812.720.7	12,6
M25 x 1,5	3/4"	9 - 18	77	15	35	33	30	5	812.725.7	20,8
M32 x 1,5	1"	13 - 22,8	88	15	45	43	40	5	812.732.7	35
M40 x 1,5	1.1/4"	20 - 30,8	102	15	54	52	50	2	812.740.7	64,4
M50 x 1,5	1.1/2"	21 - 36,8	106	18	63	60	58	2	812.750.7	80,8
M63 x 1,5	2"	27 - 44,0	116	18	77	74	68	2	812.763.7	125,8

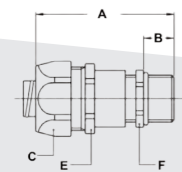

ISO cable-hose fitting, male, nickel plated brass, silicone clamping rubber up to max +220 °C (including connection set)



THREAD ISO	UIG/UI SIZE (INCH)	CLAMPING RANGE (MM)	DIMENSIONS IN MM					STANDARD PACKAGE	ARTICLE NUMBER	WEIGHT (KG/100)
			A	B	C	E	F			
M16 x 1,5	5/16"	4 - 6	50	5	26	24	18	10	812.715.73	7,4
M16 x 1,5	3/8"	4 - 9	50	5	26	24	18	10	812.716.73	9,4
M20 x 1,5	1/2"	4,5 - 12	53	6	29	27	22	10	812.720.73	11,5
M25 x 1,5	1/2"	10 - 13	57	7	29	27	28	5	812.722.73	13,5

## FITTINGS FOR UI / UIG, IP 40, NICKEL PLATED BRASS

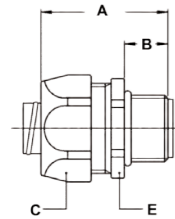

Pg straight fitting, male, nickel plated brass (including connection set)



THREAD PG	UIG / UI SIZE (INCH)	MIN. INTERNAL BORE (MM)	DIMENSIONS IN MM					STANDARD PACKAGE	ARTICLE NUMBER	WEIGHT (KG/100)
			A	B	C	D	E			
Pg 9	5/16"	6,8	35	12	26	-	24	10	810.009.7	6,4
Pg 11	5/16"	6,8	35	12	26	-	24	10	810.012.7	7,2
Pg 9	3/8"	9,8	35	12	26	-	24	10	810.010.7	6,4
Pg 11	3/8"	9,8	35	12	26	-	24	10	810.011.7	7,2
Pg 13,5	3/8"	9,8	35	12	26	-	24	10	810.013.7	7,2
Pg 16	1/2"	13,9	37	13	29	-	27	10	810.016.7	8,1
Pg 21	3/4"	18,5	40	15	35	-	33	5	810.021.7	11,4
Pg 29	1"	22,8	46	15	45	-	43	5	810.029.7	27,6
Pg 36	1.1/4"	30,8	52	16	54	-	52	2	810.036.7	38,4
Pg 42	1.1/2"	36,8	56	18	63	-	60	2	810.042.7	52,8
Pg 48	2"	47,8	66	20	77	-	74	2	810.048.7	81,4

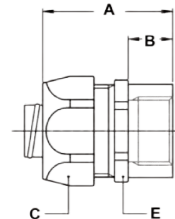

Pg straight fitting, female, nickel plated brass (including connection set)



THREAD PG	UIG / UI SIZE (INCH)	MIN. INTERNAL BORE (MM)	DIMENSIONS IN MM					STANDARD PACKAGE	ARTICLE NUMBER	WEIGHT (KG/100)
			A	B	C	D	E			
Pg 11	5/16"	6,8	35	12	26	-	24	10	810.312.7	6,7
Pg 13,5	5/16"	6,8	35	12	26	-	24	10	810.314.7	7,2
Pg 11	3/8"	9,8	35	12	26	-	24	10	810.311.7	6,9
Pg 13,5	3/8"	9,8	35	12	26	-	24	10	810.313.7	7,4
Pg 16	1/2"	13,9	37	13	29	-	27	10	810.316.7	8,1
Pg 21	3/4"	18,5	40	15	35	-	33	5	810.321.7	12,3
Pg 29	1"	22,8	46	15	45	-	43	5	810.329.7	23,3
Pg 36	1.1/4"	30,8	52	16	54	-	52	2	810.336.7	33,1
Pg 42	1.1/2"	36,8	56	18	63	-	60	2	810.342.7	48,8
Pg 48	2"	47,8	66	20	77	-	74	2	810.348.7	84,2

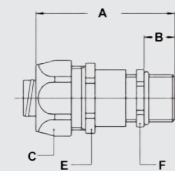

Pg cable-hose fitting, male, nickel plated brass (including connection set)



THREAD PG	UIG / UI SIZE (INCH)	CLAMPING RANGE (MM)	DIMENSIONS IN MM					STANDARD PACKAGE	ARTICLE NUMBER	WEIGHT (KG/100)
			A	B	C	E	F			
Pg 9	5/16"	4 - 6,8	55	10	26	24	17	10	810.709.7	9,2
Pg 9	3/8"	5 - 8	55	10	26	24	20	10	810.712.7	9,4
Pg 11	3/8"	5 - 9,8	55	10	26	24	20	10	810.711.7	11,1
Pg 13,5	1/2"	6 - 12	57	10	29	27	22	10	810.715.7	11,5
Pg 16	1/2"	10 - 13,9	60	10	29	27	24	10	810.716.7	13,5
Pg 21	3/4"	13 - 18	67	12	35	33	30	5	810.721.7	22,6
Pg 29	1"	18 - 22,8	80	12	45	43	40	5	810.729.7	38



## FITTINGS FOR UI / UIG, IP 40, NICKEL PLATED BRASS

Pg cable-hose fitting, male, nickel plated brass, silicone clamping rubber up to max +220 °C (including connection set)

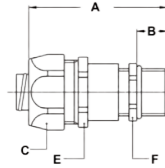

THREAD PG	UIG/UI SIZE (INCH)	CLAMPING RANGE (MM)	DIMENSIONS IN MM					STANDARD PACKAGE	ARTICLE NUMBER	WEIGHT (KG/100)
			A	B	C	E	F			
Pg 11	3/8"	5 - 9,8	51	6	26	24	22	10	810.711.73	11,1
Pg 13,5	1/2"	08 - 12	54	7	29	27	24	10	810.715.73	11,5
Pg 16	1/2"	8 - 13,9	56	6	29	27	24	10	810.716.73	13,5
Pg 21	3/4"	10 - 18	62	7	35	33	32	5	810.721.73	22,6

NPT straight fitting, male, nickel plated brass (including connection set)

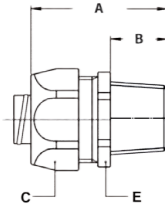

THREAD NPT	UIG/UI SIZE (INCH)	CLAMPING RANGE (MM)	DIMENSIONS IN MM					STANDARD PACKAGE	ARTICLE NUMBER	WEIGHT (KG/100)
			A	B	C	D	E			
1/2" NPT	5/16"	6,8	35	12	26	-	24	10	814.011.7	7
1/2" NPT	3/8"	9,8	35	12	26	-	24	10	814.012.7	7,2
1/2" NPT	1/2"	13,9	37	13	29	-	27	10	814.016.7	8
3/4" NPT	3/4"	18,5	40	15	35	-	33	5	814.020.7	11,9
1" NPT	1"	22,8	46	15	45	-	43	5	814.026.7	27,6
1.1/4" NPT	1.1/4"	30,8	52	16	54	-	52	2	814.035.7	43,8
1.1/2" NPT	1.1/2"	36,8	56	18	63	-	60	2	814.040.7	49,4
2" NPT	2"	47,8	66	20	77	-	74	2	814.050.7	82,9

NPT straight fitting, female, nickel plated brass (including connection set)

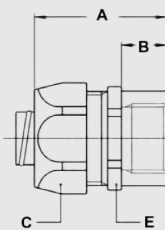

THREAD NPT	UIG/UI SIZE (INCH)	CLAMPING RANGE (MM)	DIMENSIONS IN MM					STANDARD PACKAGE	ARTICLE NUMBER	WEIGHT (KG/100)
			A	B	C	D	E			
1/2" NPT	5/16"	6,8	37	13	26	-	24	10	814.311.7	6,7
1/2" NPT	3/8"	9,8	37	13	26	-	24	10	814.312.7	6,9
1/2" NPT	1/2"	13,9	37	13	29	-	27	10	814.316.7	8
3/4" NPT	3/4"	18,5	40	15	35	-	33	5	814.320.7	12
1" NPT	1"	22,8	46	15	45	-	43	5	814.326.7	23,3
1.1/4" NPT	1.1/4"	30,8	52	16	54	-	52	2	814.335.7	33,1
1.1/2" NPT	1.1/2"	36,8	56	18	63	-	60	2	814.340.7	49,4
2" NPT	2"	47,8	66	20	77	-	74	2	814.350.7	82,7

# Compact fittings for UI, IP 40, stainless steel AISI-304



## ANACONDA COMPACT FITTINGS, IP 40, STAINLESS STEEL AISI-304 FOR MULTITITE UI

The Anaconda compact stainless steel AISI-304 are the same as used in chapter 5 (compact Sealtite). By replacing the standard polyamide clamping ring and stamped metal ferrule with a metal clamping ring and machine turned ferrule (see connection sets below) they suitable to be used in combination with UIG and UI conduits. By using the UIG / UI connection sets, a very high pull-out strength is achieved. The high quality finish of these nickel plated brass fittings gives them a very good protection against corrosion and a nice appearance.

### Material & Construction:

**Construction:** Stainless steel AISI-304 fitting, consisting of 4 parts (counter nut, clamping ring, ferrule and body).

**Temperature:** -55 °C till +260 °C continuous.

**Protection class:** IP 40.

**Colour:** Metal coloured.



Connection set, nickel plated brass, for combination with Multiflex type UI



THREAD	UI SIZE (INCH)	MIN. INTERNAL BORE (MM)	FITTING THREAD SIZE			WEIGHT (KG/100)	ARTICLE NUMBER	WEIGHT (KG/100)
			ISO	Pg	NPT			
-	5/16"	6,8	M16 x 1,5	Pg 11	1/2" NPT	10	817.210.9	2,2
-	3/8"	9,8	M16 x 1,5	Pg 11	1/2" NPT	10	817.213.9	2
-	1/2"	13,9	M20 x 1,5	Pg 16	1/2" NPT	10	817.216.9	2,4
-	3/4"	18,5	M25 x 1,5	Pg 21	3/4" NPT	5	817.220.9	3,8
-	1"	22,8	M32 x 1,5	Pg 29	1" NPT	5	817.226.9	4
-	1.1/4"	30,8	M40 x 1,5	Pg 36	1.1/4" NPT	2	817.235.9	9,8
-	1.1/2"	-	M50 x 1,5	Pg 42	1.1/2" NPT	2	817.240.6*	4,2
-	2"	-	M63 x 1,5	Pg 48	2" NPT	2	817.250.6*	9

\* Set consists of a clamping ring only, because the standard ferrules of the compact fittings for sizes 1.1/2" and 2" can be used also for UI conduit 1.1/2" and 2".

The above mentioned connection sets for UI can be used with all types of compact fittings, as outlined in chapter 5.

ISO straight compact fitting, male, stainless steel AISI-304 (including connection set)

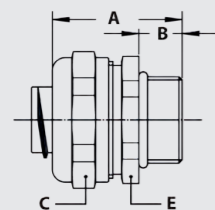

THREAD ISO	UI SIZE (INCH)	MIN. INTERNAL BORE (MM)	DIMENSIONS IN MM					STANDARD PACKAGE	ARTICLE NUMBER	WEIGHT (KG/100)
			A	B	C	D	E			
M16 x 1,5	5/16"	6,8	31	10	26	-	24	10	712.015.8	6,1
M20 x 1,5	5/16"	6,8	31	10	26	-	24	10	712.014.8	6,2
M16 x 1,5	3/8"	9,8	31	10	26	-	24	10	712.016.8	5,9
M20 x 1,5	3/8"	9,8	31	10	26	-	24	10	712.017.8	6
M20 x 1,5	1/2"	13,9	32	10	29	-	27	10	712.020.8	6,8
M25 x 1,5	3/4"	18,5	33	10	35	-	33	5	712.025.8	10,4
M32 x 1,5	1"	22,8	36	12	45	-	44	5	712.032.8	15,7
M40 x 1,5	1.1/4"	30,8	40	13	53	-	50	2	712.040.8	25,8
M50 x 1,5	1.1/2"	36,9	46	14	62	-	58	2	712.050.8	29,5
M63 x 1,5	2"	47,9	52	16	76	-	72	2	712.063.8	47,6

## COMPACT FITTINGS FOR UI, IP 40, STAINLESS STEEL AISI-304

ISO 90° fitting, compact, male, stainless steel AISI-304  
(including connection set)

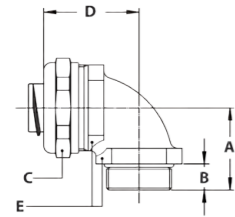

THREAD ISO	UI SIZE (INCH)	MIN. INTERNAL BORE (MM)	DIMENSIONS IN MM					STANDARD PACKAGE	ARTICLE NUMBER	WEIGHT (KG/100)
			A	B	C	D	E			
M16 x 1,5	3/8"	9,8	26	10	26	31	22	10	712.916.8	8,6
M20 x 1,5	3/8"	9,8	26	10	26	32	24	10	712.917.8	9,9
M20 x 1,5	1/2"	13,9	28	10	29	34	27	10	712.920.8	11,6
M25 x 1,5	3/4"	18,5	32	10	35	40	33	5	712.925.8	20
M32 x 1,5	1"	22,8	40	12	45	49	42	5	712.932.8	31,8
M40 x 1,5	1.1/4"	30,8	46	13	53	53	52	2	712.940.8	49,9
M50 x 1,5	1.1/2"	36,9	52	14	62	57	60	2	712.950.8	61,7
M63 x 1,5	2"	47,9	62	16	76	68	72	2	712.963.8	99,6

NPT straight compact fitting, male, stainless steel AISI-304  
(including connection set)

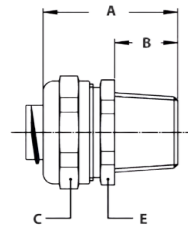

THREAD NPT	UI SIZE (INCH)	MIN. INTERNAL BORE (MM)	DIMENSIONS IN MM					STANDARD PACKAGE	ARTICLE NUMBER	WEIGHT (KG/100)
			A	B	C	D	E			
NPT 1/2"	3/8"	9,8	35	14	26	-	24	10	714.012.8	6,4
NPT 1/2"	1/2"	13,9	36	14	29	-	27	10	714.016.8	7,4
NPT 3/4"	3/4"	18,5	37	14	35	-	33	5	714.020.8	10,8
NPT 1"	1"	22,8	40	16	45	-	42	5	714.026.8	16,6
NPT 1.1/4"	1.1/4"	30,8	43	16	53	-	50	2	714.035.8	26,6
NPT 1.1/2"	1.1/2"	36,9	50	18	62	-	58	2	714.040.8	30
NPT 2"	2"	47,9	56	20	76	-	72	2	714.050.8	50,2

NPT 90° fitting, compact, male, stainless steel AISI-304  
(including connection set)

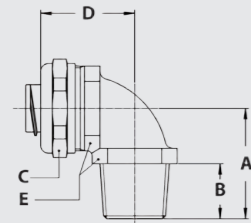

THREAD NPT	UI SIZE (INCH)	MIN. INTERNAL BORE (MM)	DIMENSIONS IN MM					STANDARD PACKAGE	ARTICLE NUMBER	WEIGHT (KG/100)
			A	B	C	D	E			
NPT 1/2"	3/8"	9,8	30	14	26	32	24	10	714.912.8	10,2
NPT 1/2"	1/2"	13,9	32	14	29	34	27	10	714.916.8	12
NPT 3/4"	3/4"	18,5	36	14	35	40	33	5	714.920.8	20,5
NPT 1"	1"	22,8	44	16	45	49	42	5	714.926.8	32,3
NPT 1.1/4"	1.1/4"	30,8	49	16	53	53	52	2	714.935.8	51,2
NPT 1.1/2"	1.1/2"	36,9	56	18	62	57	60	2	714.940.8	61,5
NPT 2"	2"	47,9	66	20	76	68	72	2	714.950.8	99,8

# Anaconda Multiflex conduit

## TYPE UI-CAP



### SMALL DIAMETERS, FLEXIBLE AND VERY CORROSION RESISTANT

Anaconda Multiflex type UI-CAP is a small bore, flexible, fully interlocked, corrosion resistant stainless steel AISI-304 core conduit with high tensile and compression strength and excellent torque stress characteristics. Developed from the original Anaconda TCA (telephone cable armoring) which was used to protect sensitive wires in public telephone handsets from acts of vandalism, the UI-CAP is typically used in sensitive measuring instruments, optic fibers, surveillance and security systems, robotics and sensor, microphone and telephone cables.

#### Material & Construction:

**Construction:** Stainless steel (AISI-304) core, fully inter locked. On demand also available in AISI-316.

**Temperature:** -100 °C till +600 °C.

**Colour:** Metal coloured.

#### Classification according NEN-EN-IEC 61386:

**Compression resistance:** Class 5, Very Heavy (4000 N).

**Impact resistance:** Class 4, Heavy (6 J).

**Tensile strength:** Class 4, Heavy (1000 N).

**Protection class:** IP 40



Inter locked

UI-CAP	DIAMETRE		BENDING RADIUS (CL)		STANDARD CARTON		SMALL CARTON		REEL		WEIGHT (kg/m)
	DN (mm)	Inside (mm)	Outside (mm)	Static (mm)	Dynamic (mm)	Metre	Article No.	Metre	Article No.	Metre	
4,5	4,5	7,5	35	45	-	575.145.0	-	-	-	-	0,08
5	5	8	35	45	-	575.030.0	-	-	-	-	0,09
5,5	5,5	8,5	40	50	-	575.040.0	-	-	-	-	0,1
6	6	9	40	50	-	575.060.0	-	-	-	-	0,11
7	7	10	45	55	-	575.045.0	-	-	-	-	0,12
8	8	11	45	55	-	575.840.0	-	-	-	-	0,14
9,5	9,5	12,5	50	60	-	511.010.0	-	-	-	-	0,19

\* Type UI-CAP is produced in production lengths from approx. 50 to 100 meters, depending on the size and production run. Anamet will select the most appropriate production lengths to reach the total ordered quantity.

On request we also can cut and deburr based on the given length specifications.

\* For 6 mm (1/4") diameter is also a galvanized steel version available (UIG-CAP code 107.006.0).

The fittings for Multiflex UI-CAP are outlined on pages 1 - 43 till 1 - 46

UI-CAP	4	4,5	5	5,5	6	7	8	9,5
ISO	-	-	-	M12	M12 - M16	M12	M12 - M16	M12 - 16 - 20
PG	-	-	-	7	7	7	7	9
NPT	-	-	-	-	-	-	-	-

# 2 Piece fittings for UI-CAP, IP 40, nickel plated brass



## ANAMET NICKEL PLATED BRASS FITTINGS FOR MULTIFLEX UI-CAP

These nickel plated brass Anamet fittings are special solution fittings which can be used with Anaconda Multiflex type UI-CAP. The fittings can be locked by either glueing or pressing the additional cap. Besides the mentioned straight fittings, special made solutions are also possible, including supplying completed assemblies with specific custom made fittings that are already mounted.

### Material & Construction:

**Construction:** Nickel plated brass fitting, consisting of 1 or 2 parts (body or body and cap). **Temperature:** -55 °C till +260 °C continuous. **Protection class:** IP 40. **Material:** Body and cap are nickel plated brass. **Colour:** Metal coloured.

Clamping cap, nickel plated brass, for combination with Multiflex type UI-CAP



THREAD	UI-CAP DN (MM)	MIN. INTERNAL BORE (MM)	FITTING THREAD SIZE			WEIGHT (KG/100)	ARTICLE NUMBER	WEIGHT (KG/100)
			ISO	Pg	NPT			
-	8	-	-	7	-	10	059.401.0	0,2

Pg straight fitting, fixed, male, nickel plated brass (excluding cap)



THREAD PG	UI-CAP DN (MM)	MIN. INTERNAL BORE (MM)	DIMENSIONS IN MM					STANDARD PACKAGE	ARTICLE NUMBER	WEIGHT (KG/100)
			A	B	C	D	E			
Pg 7	8	6,5	24	8	14	-	-	10	260.507.0	0,6

Pg straight fitting, swivel, male, nickel plated brass (excluding cap)



THREAD PG	UI-CAP DN (MM)	MIN. INTERNAL BORE (MM)	DIMENSIONS IN MM					STANDARD PACKAGE	ARTICLE NUMBER	WEIGHT (KG/100)
			A	B	C	D	E			
Pg 7	8	6,5	28	8	14	-	-	10	261.507.0	1,4

ISO straight fitting, male, nickel plated brass



THREAD ISO	UI-CAP DN (MM)	MIN. INTERNAL BORE (MM)	DIMENSIONS IN MM					STANDARD PACKAGE	ARTICLE NUMBER	WEIGHT (KG/100)
			A	B	C	D	E			
M12 x 1,5	5,5	5,5	10	6	13	-	-	10	057.261.0	0,4
M12 x 1,5	7	7	21	10	13	-	-	10	055.581.0	0,8

\* Fittings to be screwed at the outside, sustaining maximum bore.

Pg straight fitting, male, nickel plated brass



THREAD PG	SLI-CAP DN (MM)	MIN. INTERNAL BORE (MM)	DIMENSIONS IN MM					STANDARD PACKAGE	ARTICLE NUMBER	WEIGHT (KG/100)
			A	B	C	D	E			
Pg 7	5,5	5,5	10	6	13	-	-	10	043.231.0	0,4

\* Fittings to be screwed at the outside, sustaining maximum bore.



# 2 Piece fittings for UI-CAP, IP 40, stainless steel AISI-304



## ANAMET SPECIAL STAINLESS STEEL FITTINGS FOR MULTIFLEX UI-CAP

These stainless steel AISI-304 Anaconda fittings are special fittings made for Anaconda Multiflex type UI-CAP. In fact these are custom made solutions in our program. The fittings can be locked by pressing the additional cap. Anamet Europe also offers the service to cut on length and fix the fittings for you, thus supplying a complete integrated assembly.

### Material & Construction:

**Construction:** Stainless steel fitting consisting of 2 parts (body and clamping cap). **Temperature:** -100 °C till +600 °C continuous.

**Protection class:** IP 40.

**Material:** Body and clamping cap are stainless steel (AISI-304). **Colour:** Metal coloured.

Clamping cap, stainless steel AISI-304, for combination with Multiflex type UI-CAP



THREAD	UI-CAP DN (MM)	MIN. INTERNAL BORE (MM)	FITTING THREAD SIZE			STANDARD PACKAGE	ARTICLE NUMBER	WEIGHT (KG/100)
			ISO	Pg	NPT			
-	8	5,2	M12 x 1,5	-	-	10	222.703.1	0,4
-	8	5,2	M16 x 1,5	-	-	10	222.703.1	0,4

ISO straight fitting, swivel, male, stainless steel AISI-304 (excluding cap)

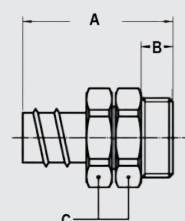

THREAD ISO	UI-CAP DN (MM)	MIN. INTERNAL BORE (MM)	DIMENSIONS IN MM					STANDARD PACKAGE	ARTICLE NUMBER	WEIGHT (KG/100)
			A	B	C	D	E			
M12 x 1,5	8	5,5	26	8	14	-	-	10	055.973.0	2
M16 x 1,5	8	5,5	28	10	17	-	-	10	055.983.0	2,8

# Fittings for UI-CAP, IP 40, nickel plated brass



Anaconda  
Multiflex



## ANACONDA NICKEL PLATED BRASS FITTINGS FOR MULTIFLEX UI-CAP

The nickel plated brass Anaconda "small design" fittings for Sealrite illustrated in chapter 5 can be used also in combination with UI-CAP conduits in sizes 6 and 9,5, by replacing the standard polyamide clamping ring and the ferrule with the metal connection set adapters mentioned below. The fittings offer high corrosion protection in combination with a very nice appearance. Thanks to the sharp thread of the turned ferrule a very high pull-out strength is achieved. Next to the mentioned straight fittings, custom made solutions are also possible. The connection set must be ordered separately.

### Material & Construction:

**Construction:** Nickel plated brass fitting, consisting of 4 parts (counter nut, clamping ring, ferrule and body).

**Temperature:** -55 °C till +260 °C continuous.

**Protection class:** IP 40.

**Colour:** Metal coloured.

**Material:** Counter nut, clamping ring, ferrule and body are nickel plated brass.

Connection set, nickel plated brass, for combination with Multiflex type UI-CAP



THREAD	UI-CAP DN (MM)	MIN. INTERNAL BORE (MM)	FITTING THREAD SIZE			STANDARD PACKAGE	ARTICLE NUMBER	WEIGHT (KG/100)
			ISO	Pg	NPT			
-	6	5,2	M12 x 1,5	Pg 7	-	10	817.206.9*	0,4
-	6	5,2	M16 x 1,5	-	-	10	817.206.9*	0,4
-	9,5	8,3	M12 x 1,5	Pg 9	-	10	817.209.9	2,2
-	9,5	8,3	M16 x 1,5	-	-	10	817.209.9	2,2
-	9,5	8,3	M20 x 1,5	-	-	10	817.209.9	2,2

\* For size 6 the set consists in a clamping ring only, the ferrule is compatible.

ISO straight fitting, small design, male, nickel plated brass (excluding connection set)

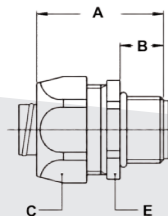

THREAD ISO	UI-CAP DN (MM)	MIN. INTERNAL BORE (MM)	DIMENSIONS IN MM					STANDARD PACKAGE	ARTICLE NUMBER	WEIGHT (KG/100)
			A	B	C	D	E			
M12 x 1,5	6	5,2	33	10	19	-	17	10	812.012.2	2,8
M16 x 1,5	6	5,2	35	12	19	-	19	10	812.013.2	3,4
M12 x 1,5	9,5	8,3	33	10	22	-	20	10	812.011.2	3,6
M16 x 1,5	9,5	8,3	35	12	22	-	20	10	812.015.2	3,8
M20 x 1,5	9,5	8,3	36	13	22	-	24	10	812.014.2	4,2

Pg straight fitting, small design, male, nickel plated brass (excluding connection set)

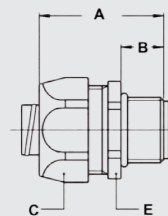

THREAD PG	UI-CAP DN (MM)	MIN. INTERNAL BORE (MM)	DIMENSIONS IN MM					STANDARD PACKAGE	ARTICLE NUMBER	WEIGHT (KG/100)
			A	B	C	D	E			
Pg 7	6	5,2	33	10	19	-	17	10	810.007.2	2,8
Pg 9	9,5	8,3	35	12	22	-	20	10	810.009.2	3,8

# Compact fittings for UI-CAP, IP 40, nickel plated brass



## ANACONDA COMPACT NICKEL PLATED BRASS FITTINGS FOR MULTIFLEX UI-CAP

A special cable-hose fitting in nickel plated brass has been developed for UI-CAP conduits. These special compact fittings are amongst other applications used in combination with UI-CAP and proximity switch adapters in order to guarantee an IP 68 sealing at the switchbox. By using the special UI-CAP clamping ring, a very high pull-out strength is achieved. Next to the mentioned straight fittings, custom made solutions are also possible. The clamping ring must be ordered separately.

### Material & Construction:

**Construction:** Nickel plated brass fitting, consisting of 6 parts (counter nut, clamping ring, ferrule, intermediate part, sealing ring and body).

**Material:** Counter nut, clamping ring, ferrule, intermediate part and body are nickel plated brass. O-rings are from NBR and the sealing ring is made from EPDM rubber.

**Temperature:** -55 °C till +125 °C continuous.

**Protection class:** IP 40 on the conduit and IP 68 on the switchbox.

**Colour:** Metal coloured.

Connection set, nickel plated brass, for combination with Multiflex type UI-CAP



THREAD	UI-CAP DN (MM)	MIN. INTERNAL BORE (MM)	FITTING THREAD SIZE			STANDARD PACKAGE	ARTICLE NUMBER	WEIGHT (KG/100)
			ISO	Pg	NPT			
-	6	5,2	M12 x 1,5	-	-	10	817.206.9*	0,4
-	6	5,2	M16 x 1,5	-	-	10	817.206.9*	0,4
-	9,5	8,3	M16 x 1,5	-	-	10	817.209.9	2,2
-	9,5	8,3	M20 x 1,5	-	-	10	817.209.9	2,2

\* Set consists of a clamping ring only.

ISO cable-hose fitting, compact, male, nickel plated brass (incl. connection set)

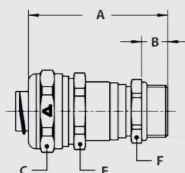

THREAD ISO	UI-CAP DN (MM)	MIN. INTERNAL BORE (MM)	DIMENSIONS IN MM					STANDARD PACKAGE	ARTICLE NUMBER	WEIGHT (KG/100)
			A	B	C	E	F			
M12 x 1,5	6	1,0 - 5,2	46	9	19	17	14	10	712.712.27	4
M16 x 1,5	6	1,0 - 5,2	47	10	19	17	18	10	712.713.27	4,7
M16 x 1,5	9,5	4,0 - 8,3	50	10	22	20	18	10	712.715.27	5,7
M20 x 1,5	9,5	4,0 - 8,3	50	10	22	20	22	10	712.714.27	6,4

# Anaconda Multiflex conduit

## TYPE RWS



Anaconda  
Multiflex

### UL LISTED, HEAVY DUTY AND CORROSION RESISTANT

The construction of the Reduced Wall Steel conduit is a galvanised steel, continuous interlocked, conduit. Due to its round form, the compression and impact resistance is very high. The RWS complies to the heavy UL-1 standard and is suitable for applications where besides flexibility a high mechanical resistance is demanded. The RWS is frequently used in heavier applications in the machine and apparatus-building and in elevators, escalators, wheelchair lifts, enclosed motor leads, where an UL-1 listed approval is required.

#### Material & Construction:

**Construction:** Continuously interlocked, zinc-coated steel strip.

**Special approvals:** Meets the requirements of UL -1 (file # E 98045). Complies with article 348, NEC. Permitted to be used in exposed and concealed locations (article 348.10); enclosed

motor leads (article 430.245(B); elevators, escalators, wheelchair lifts (article 620.21). Not suitable for wet locations.

**Temperature:** -45 °C till +230 °C.

**Colour:** Metal coloured.

#### Classification according to NEN-EN-IEC 61386:

**Compression resistance:** Class 4, Heavy (1250 N).

**Impact resistance:** Class 4, Heavy (6 J).

**Tensile strength:** Class 3, Medium (500 N).

**Protection class:** IP 40.



Continuously inter locked

RWS Size (inch)	DIAMETRE		BENDING RADIUS (CL)		STANDARD CARTON		SMALL CARTON		REEL		WEIGHT (kg/m)
	Inside (mm)	Outside (mm)	Static (mm)	Dynamic (mm)	Metre	Article No.	Metre	Article No.	Metre	Article No.	
3/8"	9,8	14,9	60	85	30	332.112.1	-	-	-	-	0,27
1/2"	16,1	22,6	90	140	30	332.116.1	-	-	-	-	0,42
3/4"	20,9	27,3	115	165	30	332.120.1	-	-	-	-	0,49
1"	25,9	34	145	225	15	332.126.1	-	-	-	-	0,76
1 1/4"	32,4	40,4	180	270	15	332.135.1	-	-	-	-	0,94
1 1/2"	39,1	48,3	215	300	7,5	332.140.1	-	-	-	-	1,13
2"	51,8	61	285	390	7,5	332.150.1	-	-	-	-	1,49

The fittings for Multiflex RWS are outlined on 1 - 49 till 1 - 50

RWS	1/4"	5/16"	3/8"	1/2"	3/4"	1"	1 1/4"	1 1/2"	2"	2 1/2"	3"	4"
ISO	-	-	-	-	-	-	-	-	-	-	-	-
PG	-	-	-	-	-	-	-	-	-	-	-	-
NPT	-	-	1/2"	1/2"	3/4"	1"	1 1/4"	1 1/2"	2"	-	-	-

# Anaconda Multiflex conduit

## TYPE RWA



### UL LISTED, LIGHT AND VERY CORROSION RESISTANT

Anaconda Multiflex type RWA is a lightweight aluminum conduit that is both flexible and corrosion resistant. The conduit is designed for applications in countries that require a UL-1 certification for metal uncovered conduits. The areas of application are various, like p.e. elevators, escalators, lift systems for the disabled, cookers, ovens, burners, household appliances and lamps. RWA can also be used in underground applications to protect cables as it is resistant against corrosion and rodent attacks.

#### Material & Construction:

**Construction:** Aluminum, continuously inter locked.

**Special approvals:** Meets the requirements of UL -1 (file # 98045) and CSA (size 3/8" only).

Complies with article 348, NEC.

Permitted to be used in exposed and concealed

locations (article 348.10); enclosed motor leads (article 430.245(B); elevators, escalators, wheelchair lifts (article 620.21). Not suitable for wet locations.

**Temperature:** -45 °C till +260 °C.

**Colour:** Metal coloured.

#### Classification according to NEN-EN-IEC 61386:

**Compression resistance:** Class 4, Heavy (1250 N).

**Impact resistance:** Class 4, Heavy (6 J).

**Tensile strength:** Class 3, Medium (500 N).

**Protection class:** IP 40.



Continuously inter locked

RWA	DIAMETRE		BENDING RADIUS (CL)		STANDARD CARTON		SMALL CARTON		REEL		WEIGHT
	Size (inch)	Inside (mm)	Outside (mm)	Static (mm)	Dynamic (mm)	Metre	Article No.	Metre	Article No.	Metre	
3/8"	9,8	14,9	60	85	30	332.012.1	-	-	-	-	0,1
1/2"	16,1	22,6	90	140	30	332.016.1	-	-	-	-	0,16
3/4"	20,9	27,3	115	165	30	332.020.1	-	-	-	-	0,22
1"	25,9	34	145	225	15	332.026.1	-	-	-	-	0,38
1 1/4"	32,4	40,4	180	270	15	332.035.1	-	-	-	-	0,45
1 1/2"	39,1	48,3	215	300	7,5	332.040.1	-	-	-	-	0,57
2"	51,8	61	285	390	7,5	332.050.1	-	-	-	-	0,72

The fittings for Multiflex RWA are outlined on page 1 - 49 till 1 -50

RWA	1/4"	5/16"	3/8"	1/2"	3/4"	1"	1 1/4"	1 1/2"	2"	2 1/2"	3"	4"
ISO	-	-	-	-	-	-	-	-	-	-	-	-
PG	-	-	-	-	-	-	-	-	-	-	-	-
NPT	-	-	1/2"	1/2"	3/4"	1"	1 1/4"	1 1/2"	2"	-	-	-



# 1 Piece fittings for RWS / RWA, IP 40, zinc die cast

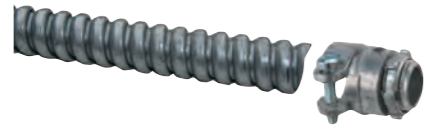

Anaconda  
Multiflex

## ANAMET ZINC DIE CAST FITTINGS FOR MULTIFLEX RWS / RWA

These zinc die cast fittings are light in weight and corrosion resistant. They are certified according to UL (for 3/8" size also CSA) for use in combination with uncovered metal flexible conduit type RWS (Reduced Wall Steel) and RWA (Reduced Wall Aluminum).

### Material & Construction:

**Construction:** Zinc die cast fitting, consisting of 1 piece.

**Material:** Zinc die cast.

**Temperature:** -55 °C till +300 °C continuous.

**Protection class:** IP 40.

**Colour:** Metal coloured.

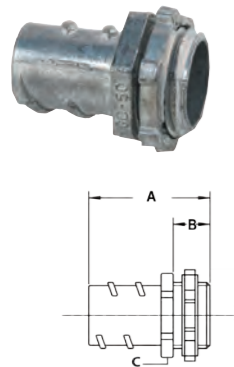

NPT straight fitting, male, zinc die cast (including NPT lock nut)



THREAD NPT	RWA SIZE (INCH)	MIN. INTERNAL BORE (MM)	DIMENSIONS IN MM					STANDARD PACKAGE	ARTICLE NUMBER	WEIGHT (KG/100)
			A	B	C	D	E			
1/2" NPT	3/8"	7,8	33	11	23	-	-	50	296.112.5	2,0
1/2" NPT	1/2"	11,7	35	12	23	-	-	50	296.116.5	2,2
3/4" NPT	3/4"	16,8	41	12	29	-	-	25	296.120.5	3,6

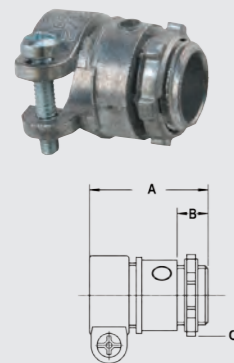

NPT straight fitting, male, zinc die cast (including NPT lock nut)



THREAD NPT	RWA SIZE (INCH)	MIN. INTERNAL BORE (MM)	DIMENSIONS IN MM					STANDARD PACKAGE	ARTICLE NUMBER	WEIGHT (KG/100)
			A	B	C	D	E			
1/2" NPT	3/8"	9,8	26	11	28	-	-	25	296.012.0	2,6
1/2" NPT	1/2"	13,7	36	11	36	-	-	25	296.016.0	3,4
3/4" NPT	3/4"	18,8	39	11	40	-	-	25	296.020.0	5,4
1" NPT	1"	23,8	45	14	50	-	-	10	296.026.0	7,8
1.1/4" NPT	1.1/4"	31,6	49	16	57	-	-	10	296.035.0	8,2
1.1/2" NPT	1.1/2"	36,8	53	18	64	-	-	5	296.040.0	8,9
2" NPT	2"	48,0	60	19	78	-	-	5	296.050.0	11,4

## 1 PIECE FITTINGS FOR RWS / RWA, IP 40, ZINC DIE CAST

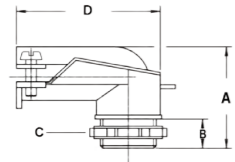

NPT 90° fitting, male, zinc die cast (including NPT lock nut)



THREAD NPT	RWA SIZE (INCH)	MIN. INTERNAL BORE (MM)	DIMENSIONS IN MM					STANDARD PACKAGE	ARTICLE NUMBER	WEIGHT (KG/100)
			A	B	C	D	E			
1/2" NPT	3/8"	9,8	28	9	44	28	-	25	296.912.0	3,6
1/2" NPT	1/2"	13,7	38	10	54	36	-	25	296.916.0	5,8
3/4" NPT	3/4"	18,8	42	11	61	40	-	25	296.920.0	7,2
1" NPT	1"	23,8	59	14	73	50	-	10	296.926.0	8,9
1.1/4" NPT	1.1/4"	31,6	70	16	102	57	-	10	296.935.0	9,6
1.1/2" NPT	1.1/2"	36,8	95	19	152	64	-	5	296.940.0	11,2
2" NPT	2"	48	102	19	152	78	-	5	296.950.0	15,4



Insulation bushing for conduit RWA (to be used a end-cap)



THREAD NPT	RWA SIZE (INCH)	MIN. INTERNAL BORE (MM)	DIMENSIONI IN MM					STANDARD PACKAGE	ARTICLE NUMBER	WEIGHT (KG/100)
			A	B	C	D	E			
-	3/8"	-	-	-	-	-	-	1000	296.412.0	0,03
-	1/2"	-	-	-	-	-	-	1000	296.216.0	0,05
-	3/4"	-	-	-	-	-	-	1000	296.220.0	0,07

# Anaconda Multiflex corrugated hose

## TYPE ANAFLEX



Anaconda  
Multiflex

### VERY FLEXIBLE, HALOGEN FREE, NON-SMOKE, WIDE TEMPERATURE RANGE, EMI / EMP SHIELDING

The Anaflex click system consists of a high quality flexible stainless steel AISI-316L hose with a nickel plated brass Anaflex Click fitting. The IP 69 system retains its liquid-tight rating up to +250° C. The Anaflex System is designed to resist oils, greases and solvents and because the system has no plastic parts fire, smoke and toxicity will not be an issue. The Anaflex system was initially designed as a self-mounting flexible piping system for HVAC installations but due to its continuous profiled tube it is also suitable for protecting cables, especially in applications where EMI / EMP shielding is required. These features make Anaflex System suitable for use in electrical and non-electrical applications in the subway-, train- and bus building industry, in closed areas such as tunnels and underground.

#### Material & Construction:

**Construction:** Flexible parallel corrugated hose, stainless steel AISI-316L.

#### Special flame properties:

- Because the Anaflex hose has no cover the flame properties according the following approvals are valid:
- EN 45545-2 (2013): R22 (interior equipment) class HL1, HL2 and HL3.
- R23 (exterior equipment) class HL1, HL2 and HL3.

- BS 6853 (1999) Tabel 7 (Interior) Category 1a, 1b and II vehicle.
- Tabel 8 (Exterior) Category 1a, 1b and II vehicle.
- London Underground LUL 1-085 (2011). Tabel 3: Extensive and grouped usage. Tabel 4: limited and dispersed usage.

**Temperature:** -70 °C till +250 °C.

**Colour:** Metal coloured.

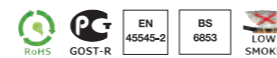
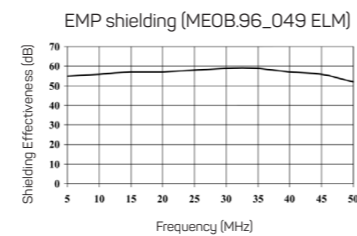

Standard corrugation

ANAFLEX®	DIAMETRE		BENDING RADIUS (CL)		STANDARD CARTON		SMALL CARTON		REEL		WEIGHT (kg/m)
	Size DN	Inside (mm)	Outside (mm)	Static (mm)	Dynamic (mm)	Metre	Article No.	Metre	Article No.	Metre	
DN 12	12,2	16,7	45	180	30	465.012.1	10	465.012.3	120	465.012.5	0,12
DN 16	16,2	21,5	60	180	30	465.016.1	10	465.016.3	90	465.016.5	0,2
DN 20	20,3	26,7	70	190	30	465.020.1	10	465.020.3	60	465.020.5	0,28
DN 25	25,4	32,3	100	215	30	465.025.1	10	465.025.3	-	-	0,39

The ANAFLEX® stainless steel hoses can be used in combination with the unique ANAFLEX®-CLICK fittings, as outlined on page 1 - 51

ANAFLEX®	-	-	-	12	16	20	25
ISO	-	-	-	M16 - M20	M20	M25	M32
PG	-	-	-	-	-	-	-
NPT	-	-	-	1/2"	1/2" - 3/4"	3/4"	1"

# Anaflex-click fittings, IP 69, nickel plated brass



## QUICK MOUNTING, RELIABLE, HIGH TEMPERATURE RESISTANCE AND VERY HIGH PROTECTION CLASS IP 69

For the stainless steel ANAFLEX® hose, a special and unique fitting has been designed. The major advantage of these nickel plated brass ANAFLEX®-CLICK fittings is the easy click-on system (no need to dis-assemble the fitting first). After tightening the counter nut (2 till 3 full turns) a strong and fully liquid-tight connection is made (IP 69).

Anaflex click is available with male thread in NPT and ISO, but also in female thread BSPT and a clamping version for rigid pipes of Ø 15 mm till Ø 22 mm.

### Material & Construction:

**Construction:** Nickel plated brass fitting, consisting of 6 parts (body, counter nut, retaining ring and filler ring are nickel plated brass, internal sealing sleeve is from PTFE and the internal flat seal is from silicone rubber).

**Special approvals:** Click system tested and approved by the "Institut für Solartechnik SPF" (Switzerland).

**Temperature:** -70 °C till +250 °C.

**Colour:** Metal coloured.

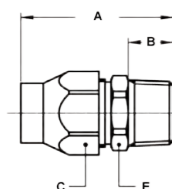

ISO straight fitting, male, nickel plated brass



THREAD ISO	ANAFLEX SIZE (DN)	MIN. INTERNAL BORE (MM)	DIMENSIONS IN MM					STANDARD PACKAGE	ARTICLE NUMBER	WEIGHT (KG/100)
			A	B	C	D	E			
M16 x 1,5	DN 12	10	47	12	24	-	22	10	842.016.0	5,9
M20 x 1,5	DN 12	10	48	13	24	-	22	10	842.017.0	6,1
M20 x 1,5	DN 16	14	54	13	29	-	27	10	842.020.0	9
M25 x 1,5	DN 20	18	60	15	36	-	34	5	842.025.0	15,6
M32 x 1,5	DN 25	24	60	15	42	-	40	5	842.032.0	21,6

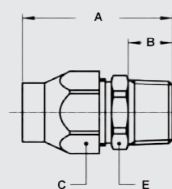

NPT straight fitting, male, nickel plated brass



THREAD NPT	ANAFLEX SIZE (DN)	MIN. INTERNAL BORE (MM)	DIMENSIONS IN MM					STANDARD PACKAGE	ARTICLE NUMBER	WEIGHT (KG/100)
			A	B	C	D	E			
NPT 1/2"	DN 12	10	50	15	24	-	22	10	844.012.0	6,3
NPT 1/2"	DN 16	14	58	17	29	-	27	10	844.016.0	9,7
NPT 3/4"	DN 16	14	59	17	29	-	27	5	844.018.0	10,5
NPT 3/4"	DN 20	18	62	17	36	-	34	5	844.020.0	16
NPT 1"	DN 25	24	63	18	42	-	40	5	844.026.0	22,8

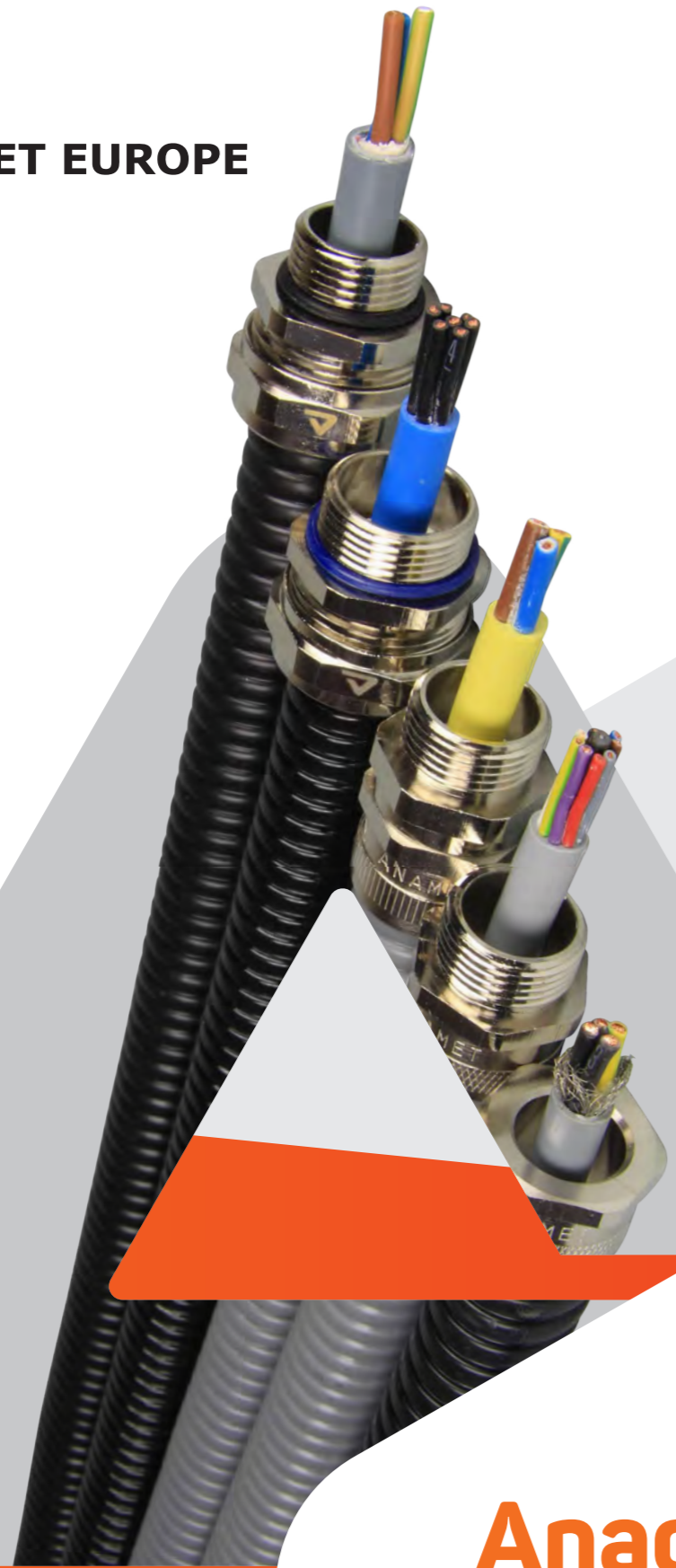











# Anaconda Multitite



# Conduit selection table

## Anaconda Multitite

MULTITITE	MATERIAL	MATERIAL	TEMPERATURE		RESISTANCE (NEN-EN-IEC 61386)			FLEXI- BILITY	RESISTANCE			APPROVALS	PROTEC- TION	PAGE
			Min.	Max.	Compr.	Impact	Tensile		UV	Oil	Class			
<b>FCD Black</b>	Galvanised steel	PVC RoHS	-20 °C	+80 °C	3 (750N)	3 (2J)	3 (500N)	++++	++++	++		IP 67	2 - 3	
<b>FCD Grey</b>	Galvanised steel	PVC RoHS	-20 °C	+80 °C	3 (750N)	3 (2J)	3 (500N)	++++	++	++		IP 67	2 - 4	
<b>FCE Black</b>	Galvanised steel	PVC RoHS	-20 °C	+80 °C	4 (1250N)	4 (6J)	4 (1000N)	++++	++++	++		IP 67	2 - 5	
<b>FCE-LFH Black</b>	Galvanised steel	TPO Halogen free RoHS	-25 °C	+80 °C	4 (1250N)	4 (6J)	4 (1000N)	++++	++++	++	  	IP 67	2 - 6	
<b>FCE-PU-VO Black</b>	Galvanised steel	TPU Halogen free RoHS	-50 °C	+105 °C	4 (1250N)	4 (6J)	4 (1000N)	++++	++++	++++	 	IP 67	2 - 7	
<b>FCE-LFHB</b>	Galvanised steel	TPO Inox braided Halogen free RoHS	-25 °C	+80 °C	4 (1250N)	4 (6J)	4 (1000N)	++++	++++	++	  	IP 67	2 - 20	

The fittings for Multitite are outlined on the next pages after the conduit.

# Anaconda Multitite conduit

## TYPE FCD BLACK



Anaconda  
Multitite

### LIGHT AND FLEXIBLE

Type FCD is a thin wall galvanised steel core conduit with a PVC cover for universal use. FCD is amongst others, being used in the building-industry, connection of control panels and protection against rodents. FCD is applied for quick and easy mounting and a light to medium mechanical protection.

#### Material & Construction:

**Construction:** Galvanised steel core, square locked with thin wall convoluted thermoplastic (PVC compound) cover.

**Cover specifications:** PVC, lead-free according to RoHS.

**Temperature:** -20 °C till +80 °C, intermittent up to +90°C.

**Colour:** Black (grey is also available).

#### Classification according to NEN-EN-IEC 61386:

**Compression resistance:** Class 3, Medium (750 N).

**Impact resistance:** Class 3, Medium (2 J).

**Tensile strength:** Class 3, Medium (500 N).

**Protection class:** IP 67 (dust-proof, water-tight).



Square locked

MULTITITE	DIAMETRE		BENDING RADIUS (CL)		SMALL COIL		STANDARD COIL		LARGE COIL		WEIGHT
	Size (dn)	Inside (mm)	Outside (mm)	Static (mm)	Dynamic (mm)	Metre	Article No. black	Metre	Article No. black	Metre	
10	7	10	30	40	-	-	-	-	50	360.010.5	0,08
12	10	14	37	50	10	360.012.1	-	-	50	360.012.5	0,14
16	13	17	45	60	10	360.016.1	-	-	50	360.016.5	0,17
18	15	19	50	70	10	360.018.1	-	-	50	360.018.5	0,19
20	17	21,5	55	80	10	360.020.1	-	-	50	360.020.5	0,23
25	21,2	26	70	100	10	360.025.1	-	-	50	360.025.5	0,31
32	28,1	34	95	125	10	360.032.1	25	360.032.2	-	-	0,4
40	37,7	45	115	160	10	360.040.1	25	360.040.2	-	-	0,6
50	48,4	56	135	190	10	360.050.1	25	360.050.2	-	-	0,88

The fittings for Multitite are outlined in on pages 2 - 8 till 2 - 19

MULTITITE	10	12	16	18	20	25	32	40	50
ISO	M10 - M12	M12 - M16	M16 - M20	M20	M20	M25	M32	M40	M50 - M63
Pg	7	9	11/13,5	13,5	16	21	29	36	48
NPT	-	-	1/2"	-	1/2"	3/4"	1"	-	-

# Anaconda Multitite conduit

## TYPE FCD GREY



### LIGHT AND FLEXIBLE

Type FCD is a thin wall galvanised steel core conduit with a PVC cover for universal use. FCD is amongst others, being used in the building-industry, connection of control panels and protection against rodents. FCD is applied for quick and easy mounting and a light to medium mechanical protection.

#### Material & Construction:

**Construction:** Galvanised steel core, square locked with thin wall convoluted thermoplastic (PVC compound) cover.

**Cover specifications:** PVC, lead-free according to RoHS.

**Temperature:** -20 °C till +80 °C, intermittent up to +90°C.

**Colour:** Grey (black is also available).

#### Classification according to NEN-EN-IEC 61386:

**Compression resistance:** Class 3, Medium (750 N).

**Impact resistance:** Class 3, Medium (2 J).

**Tensile strength:** Class 3, Medium (500 N).

**Protection class:** IP 67 (dust-proof, water-tight).



Square locked

MULTITITE	DIAMETRE		BENDING RADIUS (CL)		SMALL COIL		STANDARD COIL		LARGE COIL		WEIGHT (kg/m)
	Size (dn)	Inside (mm)	Outside (mm)	Static (mm)	Dynamic (mm)	Metre	Article No. grey	Metre	Article No. grey	Metre	
10	7	10	30	40	-	-	-	-	50	361.010.5	0,08
12	10	14	37	50	10	361.012.1	-	-	50	361.012.5	0,14
16	13	17	45	60	10	361.016.1	-	-	50	361.016.5	0,17
18	15	19	50	70	10	361.018.1	-	-	50	361.018.5	0,19
20	17	21,5	55	80	10	361.020.1	-	-	50	361.020.5	0,23
25	21,2	26	70	100	10	361.025.1	-	-	50	361.025.5	0,31
32	28,1	34	95	125	10	361.032.1	25	361.032.2	-	-	0,4
40	37,7	45	115	160	10	361.040.1	25	361.040.2	-	-	0,6
50	48,4	56	135	190	10	361.050.1	25	361.050.2	-	-	0,88

The fittings for Multitite are outlined in on pages 2 - 8 till 2 - 19

MULTITITE	10	12	16	18	20	25	32	40	50
ISO	M10 - M12	M12 - M16	M16 - M20	M20	M20	M25	M32	M40	M50 - M63
PG	7	9	11/13,5	13,5	16	21	29	36	48
NPT	-	-	1/2"	-	1/2"	3/4"	1"	-	-

# Anaconda Multitite conduit

## TYPE FCE BLACK



Anaconda  
Multitite

### FLEXIBLE AND EXTRA ROBUST

Type FCE is a high quality galvanised steel core conduit with a PVC cover. Type FCE is mainly used in the apparatus- and machine building industry where tight bending diameters are involved and medium to high mechanical protection is needed. In combination with the IP 65 and IP 68 fittings a complete liquid-tightness can be achieved. Type FCE is delivered on convenient reels (card board reels with stamped metal core).

#### Material & Construction:

**Construction:** Galvanised steel core, square locked with thin wall convoluted thermoplastic (PVC compound) cover. Type FCE is made out of thicker and higher performance strip gauge compared with FCD.

**Cover specifications:** PVC, lead-free according to RoHS.

**Temperature:** -20 °C till +80 °C, intermittent up to +90 °C.

**Colour:** Black.

#### Classification according to NEN-EN-IEC 61386:

**Compression resistance:** Class 4, Heavy (1250 N).

**Impact resistance:** Class 4, Heavy (6 J).

**Tensile strength:** Class 4, Heavy (1000 N).

**Protection class:** IP 67 (dust-proof, water-tight).



Square locked

MULTITITE	DIAMETRE		BENDING RADIUS (CL)		SMALL REEL		STANDARD REEL		LARGE REEL		WEIGHT
	Size (dn)	Inside (mm)	Outside (mm)	Static (mm)	Dynamic (mm)	Metre	Article No. black	Metre	Article No. black	Metre	
10	7	10	30	40	-	-	25	371.010.2	50	371.010.5	0,1
12	10	14	37	50	-	-	25	371.012.2	50	371.012.5	0,18
16	13	17	45	60	10	371.016.1	25	371.016.2	50	371.016.5	0,23
20	17	21,5	55	80	10	371.020.1	25	371.020.2	50	371.020.5	0,3
25	21,2	26	70	100	10	371.025.1	25	371.025.2	50	371.025.5	0,39
32	28,1	34	95	125	10	371.032.1	25	371.032.2	-	-	0,52
40	37,7	45	115	160	10	371.040.1	25	371.040.2	-	-	0,75
50	48,4	56	135	190	10	371.050.1	25	371.050.2	-	-	1,1

The fittings for Multitite are outlined in on pages 2 - 8 till 2 - 19

MULTITITE	10	12	16	18	20	25	32	40	50
ISO	M10 - M12	M12 - M16	M16 - M20	M20	M20	M25	M32	M40	M50 - M63
PG	7	9	11/13,5	13,5	16	21	29	36	48
NPT	-	-	1/2"	-	1/2"	3/4"	1"	-	-

# Anaconda Multitite conduit

## TYPE FCE-LFH BLACK



### FLEXIBLE, EXTRA ROBUST, HALOGEN FREE AND LOW SMOKE

Type FCE-LFH is, a high quality galvanised steel core conduit with a halogen free TPO cover. A halogen free, "low smoke" conduit for use in public areas. The features of the FCE-LFH cover are necessary in the field of environment and safety, as the European guidelines state that materials used in certain areas must meet special requirements regarding toxic gas emission and smoke density in case of fire. Because of the BS approvals is type FCE-LFH optimal for use in the subway-, train- and bus-building industry, in closed areas, airports, tunnels, (subway) stations and other infra-structure projects, but also in hospitals, elevators, escalators and other public areas. Type FCE-LFH is delivered on convenient reels (card board reels with stamped metal core).

#### Material & Construction:

**Construction:** Galvanised steel core, square locked with thin wall convoluted Thermoplastic Polyolefin (TPO) cover.

**Cover specifications:** Polyolefin, lead-free according to RoHS, sunlight and UV resistant, suitable for outside installation.

#### Approvals:

- EN 45545-2 (2013):  
R22 (interior equipment) class HL 1, HL 2 and HL 3.  
R23 (exterior equipment) class HL 1, HL 2 and HL 3.  
(CIT<sub>hp</sub> = 0,09, D<sub>s</sub> max = 121 and LOI = 41,5).

- BS 6853 (1999):  
Tabel 7 (Interior) Category 1b and II vehicle.  
Tabel 8 (Exterior) Category 1a, 1b and II vehicle.
- London Underground LUL 1-085 (2011).  
Tabel 4: limited and dispersed usage.  
Only sizes 20 and 25 are officially registered.

**Temperature:** -25 °C till +80 °C, intermittent up to +100 °C.

**Colour:** Black.

#### Classification according to NEN-EN-IEC 61386:

**Compression resistance:** Class 4, Heavy (1250 N).

**Impact resistance:** Class 4, Heavy (6 J).

**Tensile strength:** Class 4, Heavy (1000 N).

**Protection class:** IP 67 (dust-proof, water-tight).

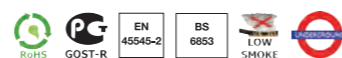

Square locked

MULTITITE	DIAMETRE		BENDING RADIUS (CL)		SMALL REEL		STANDARD REEL		LARGE REEL		WEIGHT
	Size (dn)	Inside (mm)	Outside (mm)	Static (mm)	Dynamic (mm)	Metre	Article No. black	Metre	Article No. black	Metre	
12	10	14	37	50	-	-	25	373.012.2	-	-	0,18
16	13	17	45	60	-	-	25	373.016.2	50	373.016.5	0,23
20	17	21,5	55	80	10	373.020.1	25	373.020.2	50	373.020.5	0,3
25	21,2	26	70	100	10	373.025.1	25	373.025.2	50	373.025.5	0,39
32	28,1	34	95	125	10	373.032.1	25	373.032.2	-	-	0,52
40	37,7	45	115	160	10	373.040.1	25	373.040.2	-	-	0,75
50	48,4	56	135	190	10	373.050.1	25	373.050.2	-	-	1,1

The fittings for Multitite are outlined in on pages 2 - 8 till 2 - 19

MULTITITE	10	12	16	18	20	25	32	40	50
ISO	M10 - M12	M12 - M16	M16 - M20	M20	M20	M25	M32	M40	M50 - M63
PG	7	9	11/13,5	13,5	16	21	29	36	48
NPT	-	-	1/2"	-	1/2"	3/4"	1"	-	-



# Anaconda Multitite conduit

## TYPE FCE-PU-V0 BLACK



Anaconda  
Multitite



### FLEXIBLE, EXTRA ROBUST, HALOGEN FREE AND SUPERIOR CHEMICAL RESISTANT

Type FCE-PU-V0 is, a high quality galvanised steel core conduit with a halogen free TPU cover. This conduit complies in full with the smoke and fire requirements of EN 45545-2. It is a very flexible conduit with good bend radius characteristics and is suitable for protecting cables that are subject to frequent movement and vibration such as on bogies, brake sensor cables, jumper, autocoupler and pantograph cables on low to medium speed trains. The conduit's ability to withstand stone splash, snow, ice and dirt ballast and maintain its flexibility at low temperatures and changing levels of humidity makes it suitable for use in all types of environmental conditions as well as for protecting cables on traction equipment and air conditioning systems onboard trains. It can also be used to protect CCTV and passenger information system cables on trains.

#### Material & Construction:

**Construction:** Galvanised steel core, square R23 (exterior equipment) class HL 1 and HL 2.  
locked with thin wall convoluted Thermoplastic (ClTnlp = 0,15, Ds max = 239,8 and LOI = 30,5).  
Poly-Urethane (TPU) cover.

**Cover specifications:** Polyurethane (V0 acc. R22 (interior equipment) class HL 1 and HL 2.  
UL94), halogen free, lead-free according to RoHS, oil, sunlight and UV resistant.

**Special approvals, flame properties according to:** R22 (interior equipment) class HL 1 and HL 2.

**Flame property tests:** Official tests (VTEC Laboratories Inc.) indicate that the polyurethane used in FCE-PU-V0 meets the requirements for NFPA 130, ASTM E162, ASTM E662 and BSS 7239.

**Temperature:** -50°C till +105°C, intermittent up to +125°C.

**Colour:** Black.

#### Classification according to NEN-EN-IEC 61386:

**Compression resistance:** Class 4, Heavy (1250 N).  
**Impact resistance:** Class 4, Heavy (6 J).  
**Tensile strength:** Class 4, Heavy (1000 N).  
**Protection class:** IP 67 (dust-proof, water-tight).

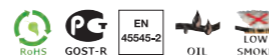

Square locked

MULTITITE	DIAMETRE		BENDING RADIUS (CL)		SMALL REEL		STANDARD REEL		LARGE REEL		WEIGHT	
	Size (dn)	Inside (mm)	Outside (mm)	Static (mm)	Dynamic (mm)	Metre	Article No. black	Metre	Article No. black	Metre		Article No. black
	12	10	14	37	50	-	-	25	374.012.2	-	-	0,18
	16	13	17	45	60	-	-	25	374.016.2	-	-	0,23
	20	17	21,5	55	80	-	-	25	374.020.2	-	-	0,3
	25	21,2	26	70	100	-	-	25	374.025.2	-	-	0,39
	32	28,1	34	95	125	-	-	25	374.032.2	-	-	0,52
	40	37,7	45	115	160	10	374.040.1	-	-	-	-	0,75
	50	48,4	56	135	190	10	374.050.1	-	-	-	-	1,1

The fittings for Multitite are outlined in on pages 2 - 8 till 2 - 19

MULTITITE	10	12	16	18	20	25	32	40	50
ISO	M10 - M12	M12 - M16	M16 - M20	M20	M20	M25	M32	M40	M50 - M63
PG	7	9	11/13,5	13,5	16	21	29	36	48
NPT	-	-	1/2"	-	1/2"	3/4"	1"	-	-

# 2 Piece fittings for FCD / FCE, IP 54, nickel plated brass



## ANACONDA IP 54 NICKEL PLATED BRASS FITTINGS FOR MULTITITE TYPE FCD / FCE

Anacnda IP 54 nickel plated brass fittings are standard fittings which can be used with Anaconda Multitite type FCD and FCE. These 2-piece fittings are universal and offer excellent corrosion protection in combination with a good appearance.

### Material & Construction:

**Construction:** Nickel plated brass fitting, consisting of 2 parts (body and cap).

**Material:** Body and cap are nickel plated brass.

**Temperature:** -55 °C till +260 °C continuous.

**Protection class:** IP 54.

**Colour:** Metal coloured.

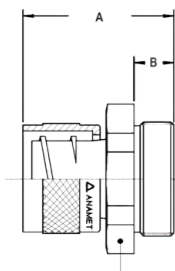

ISO straight fitting, fixed, male, nickel plated brass



THREAD ISO	MULTITITE SIZE (DN)	MIN. INTERNAL BORE (MM)	DIMENSIONS IN MM					STANDARD PACKAGE	ARTICLE NUMBER	WEIGHT (KG/100)
			A	B	C	D	E			
M10 x 1,0	10	5,5	24	8	14	-	-	10	260.110.0	1,3
M12 x 1,5	10	5,5	24	8	14	-	-	10	260.111.0	1,4
M12 x 1,5	12	8,5	26	10	18	-	-	10	260.112.0	1,8
M16 x 1,5	12	8,5	26	10	18	-	-	10	260.115.0	2
M16 x 1,5	16	11,2	27	10	20	-	-	10	260.116.0	2,3
M20 x 1,5	16	11,2	27	10	22	-	-	10	260.117.0	2,6
M20 x 1,5	18	13,2	27	10	24	-	-	10	260.118.0	2,7
M20 x 1,5	20	15,2	27	10	24	-	-	10	260.120.0	3
M25 x 1,5	25	19,2	32	12	30	-	-	5	260.125.0	5,4
M32 x 1,5	32	25,9	35	13	38	-	-	5	260.132.0	8,1
M40 x 1,5	40	34,8	41	14	48	-	-	2	260.140.0	15
M50 x 1,5	50	44,8	45	15	60	-	-	2	260.150.0	22,4
M63 x 1,5	50	44,8	46	16	70	-	-	2	260.160.0	28,6

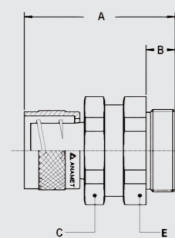

ISO straight fitting, swivel, male, nickel plated brass



THREAD ISO	MULTITITE SIZE (DN)	MIN. INTERNAL BORE (MM)	DIMENSIONS IN MM					STANDARD PACKAGE	ARTICLE NUMBER	WEIGHT (KG/100)
			A	B	C	D	E			
M10 x 1,0	10	5,5	30	8	14	-	14	10	261.110.0	1,7
M12 x 1,5	10	5,5	30	8	14	-	14	10	261.111.0	1,9
M12 x 1,5	12	8,5	34	10	18	-	18	10	261.112.0	2,4
M16 x 1,5	12	8,5	34	10	18	-	18	10	261.115.0	3,1
M16 x 1,5	16	11,2	36	10	20	-	20	10	261.116.0	3,9
M20 x 1,5	16	11,2	36	10	20	-	22	10	261.117.0	4,2
M20 x 1,5	18	13,2	37	10	24	-	24	10	261.118.0	4,4
M20 x 1,5	20	15,2	37	10	24	-	24	10	261.120.0	4,9
M25 x 1,5	25	19,2	43	12	30	-	30	5	261.125.0	8,8
M32 x 1,5	32	25,9	47	13	38	-	38	5	261.132.0	13,3
M40 x 1,5	40	34,8	56	14	48	-	48	2	261.140.0	25,1
M50 x 1,5	50	44,8	60	15	60	-	60	2	261.150.0	36,7
M63 x 1,5	50	44,8	61	16	60	-	70	2	261.160.0	47,1

## 2 PIECE FITTINGS FOR FCD / FCE, IP 54, NICKEL PLATED BRASS

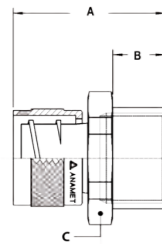

ISO straight fitting, fixed, female, nickel plated brass



Aneonda  
Multitite

THREAD ISO	MULTITITE SIZE (DN)	MIN. INTERNAL BORE (MM)	DIMENSIONS IN MM					STANDARD PACKAGE	ARTICLE NUMBER	WEIGHT (KG/100)
			A	B	C	D	E			
M12 x 1,5	12	8,5	26	11	18	-	-	10	260.312.0	1,9
M16 x 1,5	12	8,5	28	13	20	-	-	10	260.315.0	2,1
M16 x 1,5	16	11,2	29	13	20	-	-	10	260.316.0	2,4
M20 x 1,5	16	11,2	30	13	24	-	-	10	260.317.0	3
M20 x 1,5	20	15,2	30	13	24	-	-	10	260.320.0	3,2
M25 x 1,5	25	19,2	34	15	30	-	-	5	260.325.0	5,9
M32 x 1,5	32	25,9	39	16	38	-	-	5	260.332.0	8,5
M40 x 1,5	40	34,8	43	16	48	-	-	2	260.340.0	16,6
M50 x 1,5	50	44,8	47	17	60	-	-	2	260.350.0	24,5

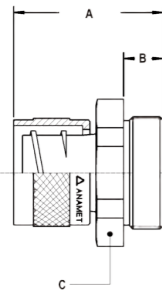

Pg straight fitting, fixed, male, nickel plated brass



THREAD PG	MULTITITE SIZE (DN)	MIN. INTERNAL BORE (MM)	DIMENSIONS IN MM					STANDARD PACKAGE	ARTICLE NUMBER	WEIGHT (KG/100)
			A	B	C	D	E			
Pg 7	10	5,5	24	8	14	-	-	10	260.207.0	1,3
Pg 9	12	8,5	26	10	18	-	-	10	260.209.0	1,9
Pg 11	16	11,2	27	10	20	-	-	10	260.211.0	2,4
Pg 13,5	18	13,2	27	10	24	-	-	10	260.213.0	3
Pg 16	20	15,2	27	10	24	-	-	10	260.216.0	3,2
Pg 21	25	19,2	32	12	30	-	-	5	260.221.0	5,5
Pg 29	32	25,9	35	13	40	-	-	5	260.229.0	8,9
Pg 36	40	34,8	41	14	50	-	-	2	260.236.0	19
Pg 48	50	44,8	45	16	65	-	-	2	260.248.0	25,3

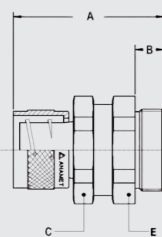

Pg straight fitting, swivel, male, nickel plated brass



THREAD PG	MULTITITE SIZE (DN)	MIN. INTERNAL BORE (MM)	DIMENSIONS IN MM					STANDARD PACKAGE	ARTICLE NUMBER	WEIGHT (KG/100)
			A	B	C	D	E			
Pg 7	10	5,5	30	8	14	-	14	10	261.207.0	1,8
Pg 9	12	8,5	34	10	18	-	18	10	261.209.0	3
Pg 11	16	11,2	36	10	20	-	20	10	261.211.0	4
Pg 13,5	18	13,2	37	10	24	-	24	10	261.213.0	4,6
Pg 16	20	15,2	37	10	24	-	24	10	261.216.0	5,2
Pg 21	25	19,2	43	12	30	-	30	5	261.221.0	9,2
Pg 29	32	25,9	47	13	38	-	40	5	261.229.0	14,6
Pg 36	40	34,8	56	14	48	-	50	2	261.236.0	27,3
Pg 48	50	44,8	61	16	60	-	65	2	261.248.0	43,8

## 2 PIECE FITTINGS FOR FCD / FCE, IP 54, NICKEL PLATED BRASS



Box connector, fixed, nickel plated brass



THREAD	MULTITITE SIZE (DN)	MIN. INTERNAL BORE (MM)	DIMENSIONS IN MM					STANDARD PACKAGE	ARTICLE NUMBER	WEIGHT (KG/100)
			A	B	C	D	E			
-	10	5,5	16	-	14	-	-	10	262.210.0	1
-	12	8,5	16	-	18	-	-	10	262.212.0	1,4
-	16	11,2	17	-	20	-	-	10	262.216.0	1,7
-	18	13,2	17	-	24	-	-	10	262.218.0	2,1
-	20	15,2	17	-	24	-	-	10	262.220.0	2,5
-	25	19,2	20	-	30	-	-	5	262.225.0	4
-	32	25,9	22	-	38	-	-	5	262.232.0	6,1
-	40	34,8	27	-	48	-	-	2	262.240.0	11,6
-	50	44,8	30	-	60	-	-	2	262.250.0	18



End cap, nickel plated brass



OUTSIDE THREAD	MULTITITE SIZE (DN)	MIN. INTERNAL BORE (MM)	DIMENSIONS IN MM					STANDARD PACKAGE	ARTICLE NUMBER	WEIGHT (KG/100)
			A	B	C	D	E			
-	10	5,5	18	6	13	-	-	10	264.110.0	0,4
-	12	8,5	18	6	17	-	-	10	264.112.0	0,4
-	16	11,2	18	6	20	-	-	10	264.116.0	0,8
-	18	12,6	19	6	22	-	-	10	264.118.0	1
-	20	15,2	19	6	24	-	-	10	264.120.0	1,2
-	25	19,2	21	7	30	-	-	5	264.125.0	1,8
-	32	25,9	22	8	38	-	-	5	264.132.0	2,9
-	40	34,8	24	8	49	-	-	2	264.140.0	5,2
-	50	44,8	25	8	60	-	-	2	264.150.0	7,6



90° elbow, ISO, inside / outside thread, nickel plated brass



OUTSIDE THREAD	INSIDE THREAD	MIN. INTERNAL BORE (MM)	DIMENSIONS IN MM					STANDARD PACKAGE	ARTICLE NUMBER	WEIGHT (KG/100)
			A	B	C	D	E			
M16 x 1,5	M16 x 1,5	-	26	10	-	24	22	10	783.016.0	6
M20 x 1,5	M20 x 1,5	-	26	10	-	25	24	10	783.020.0	10
M25 x 1,5	M25 x 1,5	-	32	10	-	34	33	5	783.025.0	16
M32 x 1,5	M32 x 1,5	-	40	12	-	40	42	5	783.032.0	26

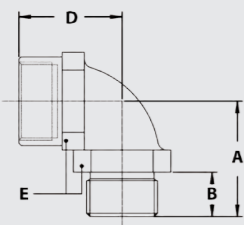

# Compact fittings for FCD / FCE, IP 65, nickel plated brass



Anaconda  
Multitite



## ANACONDA COMPACT FITTINGS, IP 65, NICKEL PLATED BRASS FOR MULTITITE FCD / FCE

Anaconda compact IP 65 fittings are made from nickel plated brass and can be used in combination with FCD and FCE conduit. Anaconda compact fittings offers good corrosion protection, a higher degree of protection (IP 65), and have a nice appearance. Because the design is universal up to 1", all types of Anaconda fittings are possible in this range.

### Material & Construction:

**Construction:** Nickel plated brass fitting, consisting of 4 parts (counter nut, clamping ring, ferrule and body).

**Material:** Counter nut and body are nickel plated brass. Ferrule is from passivated brass and clamping ring is from PA 6. The clamping rubbers of the cable-hose fittings are made from EPDM.

**Special approvals:** The cable-hose fittings have clamping rubbers from flame retardant VO-rated EPDM and are HL 1, HL 2 and HL 3 according EN 45545-2, R22 and R23.

**Temperature:** -45 °C till +105 °C continuous.

**Protection class:** IP 65. Cable-hose fittings are IP 68 on the switchbox.

**Colour:** Metal coloured.



Connection set, passivated brass ferrule and PA 6 clamping ring, for combination with Multitite type FCD / FCE, IP 65



THREAD	MULTITITE SIZE (DN)	MIN. INTERNAL BORE (MM)	FITTING THREAD SIZE			STANDARD PACKAGE	ARTICLE NUMBER	WEIGHT (KG/100)
			ISO	Pg	NPT			
-	12	8,3	M16 x 1,5	Pg 11	1/2" NPT	10	817.012.0	0,8
-	16	11,2	M16 x 1,5	Pg 11	1/2" NPT	10	817.016.0	0,8
-	20	15,2	M20 x 1,5	Pg 16	1/2" NPT	10	817.020.0	1,1
-	25	19,2	M25 x 1,5	Pg 21	3/4" NPT	5	817.025.0	1,5
-	32	25,9	M32 x 1,5	Pg 29	1" NPT	5	817.032.0	3,3

The above mentioned connection sets for FCD and FCE can be used with all types of compact fittings, as outlined in chapter 5.



ISO straight fitting, compact, male, nickel plated brass (including connection set)



THREAD ISO	MULTITITE SIZE (DN)	MIN. INTERNAL BORE (MM)	DIMENSIONS IN MM					STANDARD PACKAGE	ARTICLE NUMBER	WEIGHT (KG/100)
			A	B	C	D	E			
M16 x 1,5	12	8,3	31	10	26	-	24	10	712.015.4	4,3
M20 x 1,5	12	8,3	31	10	26	-	24	10	712.014.4	4,4
M16 x 1,5	16	11,2	31	10	26	-	24	10	712.016.4	4,3
M20 x 1,5	16	11,2	31	10	26	-	24	10	712.017.4	4,4
M20 x 1,5	20	15,2	32	10	29	-	27	10	712.020.4	5
M25 x 1,5	25	19,2	33	10	35	-	33	5	712.025.4	7,4
M32 x 1,5	32	25,9	36	12	45	-	42	5	712.032.4	13,9
M40 x 1,5	40	35,1	40	13	56	-	54	2	712.040.4	19,5
M50 x 1,5	40	35,1	46	14	62	-	58	2	712.045.4	28,3
M50 x 1,5	50	45,4	46	14	62	-	58	2	712.055.4	39,5
M63 x 1,5	50	45,4	52	16	76	-	72	2	712.060.4	42,6

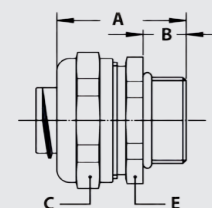



## COMPACT FITTINGS FOR FCD / FCE, IP 65, NICKEL PLATED BRASS

ISO 90° fitting, compact, male, nickel plated brass  
(including connection set)

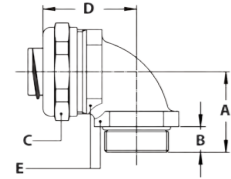

THREAD ISO	MULTITITE SIZE (DN)	MIN. INTERNAL BORE (MM)	DIMENSIONS IN MM					STANDARD PACKAGE	ARTICLE NUMBER	WEIGHT (KG/100)
			A	B	C	D	E			
M16 x 1,5	12	8,3	26	10	26	31	22	10	712.915.4	7
M20 x 1,5	12	8,3	26	10	26	32	24	10	712.914.4	8,3
M16 x 1,5	16	11,2	26	10	26	31	22	10	712.916.4	7
M20 x 1,5	16	11,2	26	10	26	32	24	10	712.917.4	8,3
M20 x 1,5	20	15,2	28	10	29	34	27	10	712.920.4	9,8
M25 x 1,5	25	19,2	32	10	35	40	33	5	712.925.4	17
M32 x 1,5	32	25,9	40	12	45	49	42	5	712.932.4	30
M50 x 1,5	40	35,1	52	14	62	57	60	2	712.945.4	60,5
M63 x 1,5	50	45,4	62	16	76	68	72	2	712.960.4	94,6

ISO cable-hose fitting, compact, male, nickel plated brass, double seal  
according EN 45545-2, HL1 / HL2 / HL 3, table R22 and R23  
(incl. connection set)

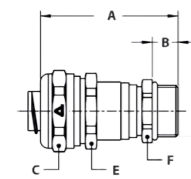

THREAD ISO	MULTITITE SIZE (DN)	CLAMPING RANGE (MM)	DIMENSIONS IN MM					STANDARD PACKAGE	ARTICLE NUMBER	WEIGHT (KG/100)
			A	B	C	E	F			
M16 x 1,5	12	4,0 - 8,3	50	10	26	24	18	10	712.715.4	7,2
M20 x 1,5	12	4,0 - 8,3	50	10	26	24	22	10	712.714.4	7,8
M16 x 1,5	16	4,0 - 9,5	50	10	26	24	18	10	712.716.4	7,2
M20 x 1,5	16	4,0 - 9,5	50	10	26	24	22	10	712.717.4	7,8
M20 x 1,5	20	6,0 - 13,0	53	10	29	27	22	10	712.720.4	8,2
M25 x 1,5	20	6,0 - 13,0	54	10	29	27	27	5	712.722.4	9,6
M25 x 1,5	25	11,0 - 18,0	56	10	35	33	27	5	712.725.4	12,5
M32 x 1,5	25	11,0 - 18,0	58	12	35	33	35	5	712.728.4	15,8
M32 x 1,5	32	16,0 - 25,0	61	12	45	42	35	5	712.732.4	22,5
M40 x 1,5	32	16,0 - 25,0	63	13	45	42	43	2	712.735.4	26,7

ISO straight swivel fitting, male, nickel plated brass  
(including connection set)

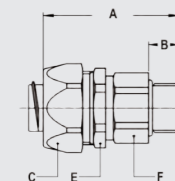

THREAD ISO	MULTITITE SIZE (DN)	MIN. INTERNAL BORE (MM)	DIMENSIONS IN MM					STANDARD PACKAGE	ARTICLE NUMBER	WEIGHT (KG/100)
			A	B	C	E	F			
M16 x 1,5	12	8,3	48	10	26	24	21	10	813.015.4	8,1
M16 x 1,5	16	11,2	48	10	26	24	21	10	813.016.4	8,1
M20 x 1,5	20	15,2	49	10	29	27	25	10	813.020.4	10,2
M25 x 1,5	25	19,2	49	10	35	33	31	5	813.025.4	13,8
M32 x 1,5	32	25,9	55	12	45	42	38	5	813.032.4	32,5
M50 x 1,5	40	35,1	65	14	62	58	55	2	813.045.4	74
M63 x 1,5	50	45,4	74	16	76	72	68	2	813.060.4	130

## COMPACT FITTINGS FOR FCD / FCE, IP 65, NICKEL PLATED BRASS

ISO 90° swivel fitting, male, nickel plated brass  
(including connection set)



Aneonda  
Multitite

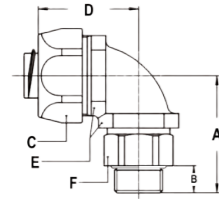

THREAD ISO	MULTITITE SIZE (DN)	MIN. INTERNAL BORE (MM)	DIMENSIONS IN MM						STANDARD PACKAGE	ARTICLE NUMBER	WEIGHT (KG/100)
			A	B	C	D	E	F			
M16 x 1,5	12	8,3	39	10	26	35	22	22	10	813.915.4	10,8
M16 x 1,5	16	11,2	39	10	26	35	22	22	10	813.916.4	10,8
M20 x 1,5	20	15,2	39	10	29	37	27	25	10	813.920.4	13,2
M25 x 1,5	25	19,2	46	10	35	44	33	31	5	813.925.4	22,8
M32 x 1,5	32	25,9	55	12	45	55	42	38	5	813.932.4	41,4

Pg straight fitting, compact, male, nickel plated brass  
(including connection set)

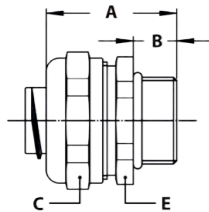

THREAD PG	MULTITITE SIZE (DN)	MIN. INTERNAL BORE (MM)	DIMENSIONS IN MM					STANDARD PACKAGE	ARTICLE NUMBER	WEIGHT (KG/100)
			A	B	C	D	E			
Pg 11	16	11,2	30	10	26	-	24	10	710.011.4	4,4
Pg 13,5	16	11,2	30	10	26	-	24	10	710.013.4	4,6
Pg 16	20	15,2	32	10	29	-	27	10	710.016.4	5,1
Pg 21	25	19,2	33	10	35	-	33	5	710.021.4	7,3
Pg 29	32	25,9	36	12	45	-	44	5	710.029.4	14,4
Pg 42	40	35,1	46	14	62	-	60	2	710.040.4	29,3
Pg 48	50	45,4	52	16	76	-	72	2	710.050.4	42,6

Pg 90° fitting, compact, male, nickel plated brass  
(including connection set)

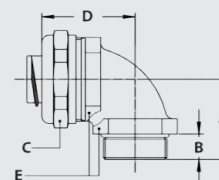

THREAD PG	MULTITITE SIZE (DN)	MIN. INTERNAL BORE (MM)	DIMENSIONS IN MM					STANDARD PACKAGE	ARTICLE NUMBER	WEIGHT (KG/100)
			A	B	C	D	E			
Pg 11	16	11,2	26	10	26	32	24	10	710.911.4	8,1
Pg 13,5	16	11,2	26	10	26	32	24	10	710.913.4	8,4
Pg 16	20	15,2	28	10	29	34	27	10	710.916.4	9,8
Pg 21	25	19,2	32	10	35	40	33	5	710.921.4	16,5
Pg 29	32	25,9	40	12	45	49	42	5	710.929.4	30,8
Pg 42	40	35,1	52	14	62	57	60	2	710.940.4	60,5
Pg 48	50	45,4	62	16	76	68	72	2	710.950.4	96,1

## COMPACT FITTINGS FOR FCD / FCE, IP 65, NICKEL PLATED BRASS

NPT straight fitting, compact, male, nickel plated brass  
(including connection set)

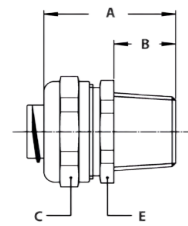

THREAD NPT	MULTITITE SIZE (DN)	MIN. INTERNAL BORE (MM)	DIMENSIONS IN MM					STANDARD PACKAGE	ARTICLE NUMBER	WEIGHT (KG/100)
			A	B	C	D	E			
NPT 1/2"	16	11,2	35	14	26	-	24	10	714.012.4	4,8
NPT 1/2"	20	15,2	36	14	29	-	27	10	714.016.4	5,6
NPT 3/4"	25	19,2	37	14	35	-	33	5	714.020.4	7,8
NPT 1"	32	25,9	40	16	45	-	42	5	714.026.4	14,8
NPT 1.1/2"	40	35,1	50	18	62	-	58	2	714.045.4	28,8
NPT 2"	50	45,4	56	20	76	-	72	2	714.055.4	45,2

NPT 90° fitting, compact, male, nickel plated brass  
(including connection set)

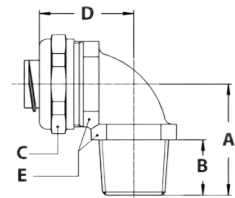

THREAD NPT	MULTITITE SIZE (DN)	MIN. INTERNAL BORE (MM)	DIMENSIONS IN MM					STANDARD PACKAGE	ARTICLE NUMBER	WEIGHT (KG/100)
			A	B	C	D	E			
NPT 1/2"	16	11,2	30	14	26	32	24	10	714.912.4	8,6
NPT 1/2"	20	15,2	32	14	29	34	27	10	714.916.4	10,2
NPT 3/4"	25	19,2	36	14	35	40	33	5	714.920.4	17,5
NPT 1"	32	25,9	44	16	45	49	42	5	714.926.4	30,5
NPT 1.1/2"	40	35,1	56	18	62	57	60	2	714.945.4	60,3
NPT 2"	50	45,4	66	20	76	68	72	2	714.955.4	94,8

NPT 90° swivel fitting, male, nickel plated brass  
(including connection set)

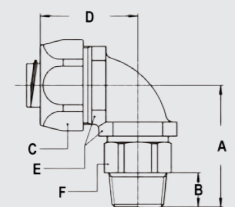

THREAD NPT	MULTITITE SIZE (DN)	MIN. INTERNAL BORE (MM)	DIMENSIONS IN MM						STANDARD PACKAGE	ARTICLE NUMBER	WEIGHT (KG/100)
			A	B	C	D	E	F			
NPT 1/2"	16	10,7	41	12	26	35	22	22	10	819.912.4	12
NPT 1/2"	20	13,9	41	12	29	37	27	25	10	819.916.4	14
NPT 3/4"	25	17,4	48	12	35	44	33	31	5	819.920.4	23,5
NPT 1"	32	23,4	56	13	45	55	42	38	5	819.926.4	42

## COMPACT FITTINGS FOR FCD / FCE, IP 65, NICKEL PLATED BRASS

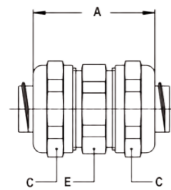

Conduit connector, nickel plated brass (including connection set)



Aneonda  
Multitite

THREAD	MULTITITE SIZE (DN)	MIN. INTERNAL BORE (MM)	DIMENSIONS IN MM					STANDARD PACKAGE	ARTICLE NUMBER	WEIGHT (KG/100)
			A	B	C	D	E			
-	12	8,3	41	-	26	-	24	10	784.010.4	7,4
-	16	11,2	41	-	26	-	24	10	784.012.4	7,4
-	20	15,2	45	-	29	-	27	10	784.016.4	8,8
-	25	19,2	48	-	35	-	33	5	784.020.4	13
-	32	25,9	53	-	45	-	44	5	784.026.4	25,2
-	40	35,1	69	-	62	-	58	2	784.045.4	52,4
-	50	45,1	78	-	76	-	72	2	784.055.4	76,3

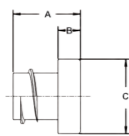

End cap, nickel plated brass



THREAD	MULTITITE SIZE (DN)	MIN. INTERNAL BORE (MM)	DIMENSIONS IN MM					STANDARD PACKAGE	ARTICLE NUMBER	WEIGHT (KG/100)
			A	B	C	D	E			
-	10	5,5	18	6	13	-	-	10	264.110.0	0,4
-	12	8,5	18	6	17	-	-	10	264.112.0	0,4
-	16	11,2	18	6	20	-	-	10	264.116.0	0,8
-	18	12,6	19	6	22	-	-	10	264.118.0	1
-	20	15,2	19	6	24	-	-	10	264.120.0	1,2
-	25	19,2	21	7	30	-	-	5	264.125.0	1,8
-	32	25,9	22	8	38	-	-	5	264.132.0	2,9
-	40	34,8	24	8	49	-	-	2	264.140.0	5,2
-	50	44,8	25	8	60	-	-	2	264.150.0	7,6



Lock nuts, nickel plated brass, ISO



THREAD ISO	MULTITITE SIZE (DN)	MIN. INTERNAL BORE (MM)	DIMENSIONS IN MM					STANDARD PACKAGE	ARTICLE NUMBER	WEIGHT (KG/100)
			A	B	C	D	E			
M16 x 1,5	-	-	2,8	-	19	-	-	50	880.116.0	0,4
M20 x 1,5	-	-	3,5	-	24	-	-	50	880.120.0	0,6
M25 x 1,5	-	-	3,5	-	30	-	-	25	880.125.0	0,9
M32 x 1,5	-	-	4,5	-	35	-	-	20	880.132.0	2,2
M40 x 1,5	-	-	4,5	-	45	-	-	10	880.140.0	3,2
M50 x 1,5	-	-	5,5	-	55	-	-	10	880.150.0	5
M63 x 1,5	-	-	6	-	70	-	-	5	880.163.0	5,6



Lock nuts, nickel plated brass, Pg



THREAD PG	MULTITITE SIZE (DN)	MIN. INTERNAL BORE (MM)	DIMENSIONS IN MM					STANDARD PACKAGE	ARTICLE NUMBER	WEIGHT (KG/100)
			A	B	C	D	E			
Pg 11	-	-	2,9	-	21	-	-	50	880.011.0	0,3
Pg 16	-	-	3,1	-	26	-	-	50	880.016.0	0,5
Pg 21	-	-	3,6	-	32	-	-	20	880.021.0	0,8
Pg 29	-	-	4,1	-	41	-	-	20	880.029.0	1,4
Pg 36	-	-	5,1	-	51	-	-	10	880.036.0	2,1
Pg 42	-	-	5,1	-	60	-	-	5	880.042.0	3,6
Pg 48	-	-	5,6	-	64	-	-	5	880.048.0	4,1

# Compact fittings for FCD / FCE, IP 68, nickel plated brass



## ANACONDA COMPACT FITTINGS, IP 68, NICKEL PLATED BRASS FOR MULTITITE FCD AND FCE

The nickel plated brass Anaconda compact IP 68 fittings are designed for use in combination with FCD and FCE conduit. Anaconda compact fittings offer a good corrosion protection, a high degree of protection (IP 68), and have a nice appearance. Because the design is universal up to 1" all types of Anaconda compact fittings are possible in this range.

### Material & Construction:

**Construction:** Nickel plated brass fitting, consisting of 5 parts (counter nut, filler ring, sealing sleeve, ferrule and body).

**Material:** Counter nut, filler ring, ferrule and body are nickel plated brass. Sealing sleeve is NBR-rubber.

**Special approvals:** The cable-hose fittings have clamping rubbers from flame retardant VO-rated

EPDM and are HL 1, HL 2 and HL 3 according EN 45545-2, R22 and R23.

**Temperature:** -45 °C till +105 °C continuous.

**Protection class:** IP 68, swivel fittings are IP 65 (dynamic applications) or IP 67 (static applications).

**Colour:** Metal coloured.



Connection set, nickel plated brass parts and NBR rubber sleeve, for combination with Multiflex type FCD / FCE, IP 68



THREAD ISO	MULTITITE SIZE (DN)	MIN. INTERNAL BORE (MM)	FITTING THREAD SIZE			STANDARD PACKAGE	ARTICLE NUMBER	WEIGHT (KG/100)
			ISO	Pg	NPT			
-	16	11,2	M16 x 1,5	Pg 11		10	817.816.0	0,8
-	16	11,2	M20 x 1,5	Pg 13,5	1/2" NPT	10	817.816.0	0,8
-	20	15,2	M20 x 1,5	Pg 16	1/2" NPT	10	817.820.0	1,1
-	25	19,2	M25 x 1,5	Pg 21	3/4" NPT	5	817.825.0	1,5
-	32	25,9	M32 x 1,5	Pg 29	1" NPT	5	817.832.0	3,3

The above mentioned connection sets for FCD and FCE can be used with all types of compact fittings, as outlined in chapter 5.

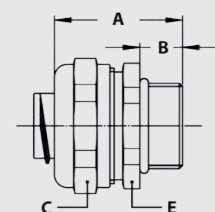

ISO straight fitting, compact, male, nickel plated brass (including connection set)



THREAD ISO	MULTITITE SIZE (DN)	MIN. INTERNAL BORE (MM)	DIMENSIONS IN MM					STANDARD PACKAGE	ARTICLE NUMBER	WEIGHT (KG/100)
			A	B	C	D	E			
M12 x 1,5	12	8,5	31	10	22	-	20	10	812.012.5	3,8
M16 x 1,5	16	11,2	31	10	26	-	24	10	712.016.5	4,3
M20 x 1,5	16	11,2	31	10	26	-	24	10	712.017.5	4,4
M20 x 1,5	20	15,2	32	10	29	-	27	10	712.020.5	5
M25 x 1,5	25	19,2	33	10	35	-	33	5	712.025.5	7,4
M32 x 1,5	32	25,9	36	12	42	-	44	5	712.032.5	13,9
M40 x 1,5	40	34,5	45	14	59	-	55	2	812.040.5	18,8



## COMPACT FITTINGS FOR FCD / FCE, IP 68, NICKEL PLATED BRASS

ISO straight swivel fitting, male, nickel plated brass, IP 65 / IP 67  
(including connection set)



Aneonda  
Multitite

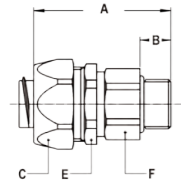

THREAD ISO	MULTITITE SIZE (DN)	MIN. INTERNAL BORE (MM)	DIMENSIONS IN MM					STANDARD PACKAGE	ARTICLE NUMBER	WEIGHT (KG/100)
			A	B	C	E	F			
M16 x 1,5	16	10,7	48	10	26	24	21	10	813.016.5	8,1
M20 x 1,5	20	13,9	49	10	29	27	25	10	813.020.5	10,2
M25 x 1,5	25	17,4	49	10	35	33	31	5	813.025.5	13,8
M32 x 1,5	32	23,4	55	12	45	42	38	5	813.032.5	32,5

ISO 90° fitting, compact, male, nickel plated brass  
(including connection set)

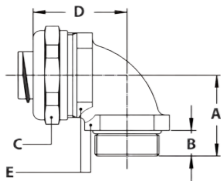

THREAD ISO	MULTITITE SIZE (DN)	MIN. INTERNAL BORE (MM)	DIMENSIONS IN MM					STANDARD PACKAGE	ARTICLE NUMBER	WEIGHT (KG/100)
			A	B	C	D	E			
M16 x 1,5	16	11,2	26	10	26	31	22	10	712.916.5	7
M20 x 1,5	16	11,2	26	10	26	32	24	10	712.917.5	8,3
M20 x 1,5	20	15,2	28	10	29	34	27	10	712.920.5	9,8
M25 x 1,5	25	19,2	32	10	35	40	33	5	712.925.5	17
M32 x 1,5	32	25,9	40	12	45	49	42	5	712.932.5	30

ISO cable-hose fitting, compact, male, nickel plated brass, double seal according EN 45545-2, HL 1 / HL 2 / HL 3, table R22 and R23  
(incl. connection set)

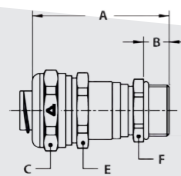

THREAD ISO	MULTITITE SIZE (DN)	CLAMPING RANGE (MM)	DIMENSIONS IN MM					STANDARD PACKAGE	ARTICLE NUMBER	WEIGHT (KG/100)
			A	B	C	E	F			
M16 x 1,5	16	4,0 - 9,5	50	10	26	24	18	10	712.716.5	7,2
M20 x 1,5	16	4,0 - 9,5	50	10	26	24	22	10	712.717.5	7,8
M20 x 1,5	20	6,0 - 13,0	53	10	29	27	22	10	712.720.5	8,2
M25 x 1,5	20	6,0 - 13,0	54	10	29	27	27	5	712.722.5	9,6
M25 x 1,5	25	11,0 - 18,0	56	10	35	33	27	5	712.725.5	12,5
M32 x 1,5	25	11,0 - 18,0	58	12	35	33	35	5	712.728.5	15,8
M32 x 1,5	32	16,0 - 25,0	61	12	45	42	35	5	712.732.5	22,5
M40 x 1,5	32	16,0 - 25,0	63	13	45	42	43	2	712.735.5	26,7

## COMPACT FITTINGS FOR FCD / FCE, IP 68, NICKEL PLATED BRASS

ISO straight fitting, female, nickel plated brass  
(including connection set)

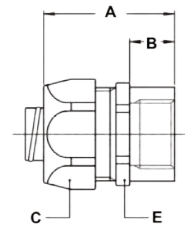

THREAD ISO	MULTITITE SIZE (DN)	MIN. INTERNAL BORE (MM)	DIMENSIONS IN MM					STANDARD PACKAGE	ARTICLE NUMBER	WEIGHT (KG/100)
			A	B	C	D	E			
M16 x 1,5	16	11,2	35	12	26	-	24	10	812.316.5	5,4
M20 x 1,5	20	15,2	37	13	29	-	27	10	812.320.5	8,2
M25 x 1,5	25	19,2	40	15	35	-	33	5	812.325.5	9,8
M32 x 1,5	32	25,9	46	15	45	-	43	5	812.332.5	20,5

ISO 90° swivel fitting, male, nickel plated brass  
(including connection set)

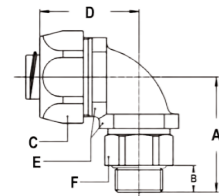

THREAD ISO	MULTITITE SIZE (DN)	MIN. INTERNAL BORE (MM)	DIMENSIONS IN MM						STANDARD PACKAGE	ARTICLE NUMBER	WEIGHT (KG/100)
			A	B	C	D	E	F			
M16 x 1,5	16	10,7	39	10	26	35	22	21	10	813.916.5	10,8
M20 x 1,5	20	13,9	39	10	29	37	27	25	10	813.920.5	13,2
M25 x 1,5	25	17,4	46	10	35	44	33	31	5	813.925.5	22,8
M32 x 1,5	32	23,4	55	12	45	55	42	38	5	813.932.5	41,4

Pg straight fitting, compact, male, nickel plated brass  
(including connection set)

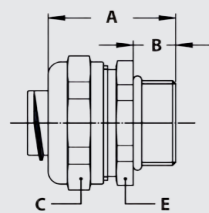

THREAD PG	MULTITITE SIZE (DN)	MIN. INTERNAL BORE (MM)	DIMENSIONS IN MM					STANDARD PACKAGE	ARTICLE NUMBER	WEIGHT (KG/100)
			A	B	C	D	E			
Pg 11	16	11,2	30	10	26	-	24	10	710.011.5	4,4
Pg 13,5	16	11,2	30	10	26	-	24	10	710.013.5	4,6
Pg 16	20	15,2	32	10	29	-	27	10	710.016.5	5,1
Pg 21	25	19,2	33	10	35	-	33	5	710.021.5	7,3
Pg 29	32	25,9	36	12	45	-	44	5	710.029.5	14,4

## COMPACT FITTINGS FOR FCD / FCE, IP 68, NICKEL PLATED BRASS

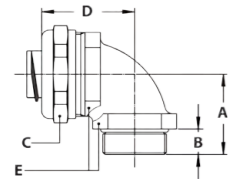

Pg 90° fitting, compact, male, nickel plated brass  
(including connection set)



Aneonda  
Multitite

THREAD PG	MULTITITE SIZE (DN)	MIN. INTERNAL BORE (MM)	DIMENSIONS IN MM					STANDARD PACKAGE	ARTICLE NUMBER	WEIGHT (KG/100)
			A	B	C	D	E			
Pg 11	16	11,2	26	10	26	32	24	10	710.911.5	8,1
Pg 13,5	16	11,2	26	10	26	32	24	10	710.913.5	8,4
Pg 16	20	15,2	28	10	29	34	27	10	710.916.5	9,8
Pg 21	25	19,2	32	10	35	40	33	5	710.921.5	16,5
Pg 29	32	25,9	40	12	45	49	42	5	710.929.5	30,8

NPT straight fitting, compact, male, nickel plated brass  
(including connection set)

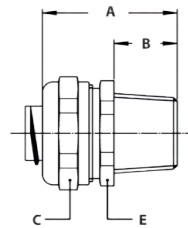

THREAD NPT	MULTITITE SIZE (DN)	MIN. INTERNAL BORE (MM)	DIMENSIONS IN MM					STANDARD PACKAGE	ARTICLE NUMBER	WEIGHT (KG/100)
			A	B	C	D	E			
NPT 1/2"	16	11,2	35	14	26	-	24	10	714.012.5	4,8
NPT 1/2"	20	15,2	36	14	29	-	27	10	714.016.5	5,6
NPT 3/4"	25	19,2	37	14	35	-	33	5	714.020.5	7,8
NPT 1"	32	25,9	40	16	45	-	42	5	714.026.5	14,8

NPT 90° fitting, compact, male, nickel plated brass  
(including connection set)

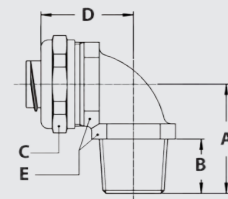

THREAD NPT	MULTITITE SIZE (DN)	MIN. INTERNAL BORE (MM)	DIMENSIONS IN MM					STANDARD PACKAGE	ARTICLE NUMBER	WEIGHT (KG/100)
			A	B	C	D	E			
NPT 1/2"	16	11,2	30	14	26	32	24	10	714.912.5	8,6
NPT 1/2"	20	15,2	32	14	29	34	27	10	714.916.5	10,2
NPT 3/4"	25	19,2	36	14	35	40	33	5	714.920.5	17,5
NPT 1"	32	25,9	44	16	45	49	42	5	714.926.5	30,5

# Anaconda Multitite conduit

## TYPE FCE-LFHB



### FLEXIBLE, EXTRA ROBUST, HALOGEN FREE AND LOW SMOKE

Type FCE-LFHB is a high quality galvanised steel core conduit with a halogen free TPO cover and a stainless steel AISI-304 braid on top. A Halogen free, "low smoke" conduit for use in public areas. The features of the FCE-LFHB cover are necessary in the field of environment and safety, as the European guidelines state that materials used in certain areas must meet special requirements regarding toxic gas emission and smoke density in case of fire. Because of the BS approvals is type FCE-LFHB optimal for use in the subway-, train- and bus-building industry, in closed areas, airports, tunnels, (subway) stations and other infra-structure projects, but also in hospitals, elevators, escalators and other public areas. Type FCE-LFHB is delivered on convenient reels (card board reels with stamped metal core).

#### Material & Construction:

**Construction:** Galvanised steel core, square locked with thin wall convoluted Thermoplastic Polyolefin (TPO compound) cover and stainless steel AISI-304 braiding.

**Cover specifications:** Polyolefin, lead-free according to RoHS, sunlight and UV resistant, suitable for outside installation.

#### Approvals:

- EN 45545-2 (2013): R22 (interior equipment) class HL 1, HL 2 and HL 3.  
R23 (exterior equipment) class HL 1, HL 2 and HL 3.

(CIT<sub>nlp</sub> = 0,09, D<sub>s</sub> max = 121 and LOI = 41,5).

- BS 6853 (1999) Tabel 7 (Interior) Category 1b and II vehicle.  
Tabel 8 (Exterior) Category 1a, 1b and II vehicle.
- London Underground LUL 1-085 (2011).  
Tabel 4: limited and dispersed usage.  
Only sizes 20 and 25 are officially registered.

**Temperature:** -25 °C till +80 °C, intermittent up to +100 °C.

**Colour:** Metal coloured.

#### Classification according to NEN-EN-IEC 61386:

**Compression resistance:** Class 4, Heavy (1250 N).

**Impact resistance:** Class 4, Heavy (6 J).

**Tensile strength:** Class 4, Heavy (1000 N).

**Protection class:** IP 67 (dust-proof, water-tight).



Square locked

FCE-LFHB	DIAMETRE		BENDING RADIUS (CL)		SMALL REEL		STANDARD REEL		LARGE REEL		WEIGHT
	Size (dn)	Inside (mm)	Outside (mm)	Static (mm)	Dynamic (mm)	Metre	Article No.	Metre	Article No.	Metre	
16	13	18,2	45	60	-	-	25	375.016.2	-	-	0,38
20	17	22,7	55	80	-	-	25	375.020.2	-	-	0,49
25	21,2	27,2	70	100	-	-	25	375.025.2	-	-	0,62
32	28,1	35,2	95	125	-	-	25	375.032.2	-	-	0,82

The fittings for Multitite FCE-LFHB are outlined in on pages 2 - 21 till 2 - 24

MULTITITE	10	12	16	18	20	25	32	40	50
ISO	M10 - M12	M12 - M16	M16 - M20	M20	M20	M25	M32	M40	M50 - M63
PG	7	9	11/13,5	13,5	16	21	29	36	48
NPT	-	-	1/2"	-	1/2"	3/4"	1"	-	-

# 2 Piece fittings for FCE-LFHB, IP 54, nickel plated brass



Anaconda  
Multitite



## ANACONDA IP 54 NICKEL PLATED BRASS FITTINGS FOR MULTITITE TYPE FCE-LFHB

Anaconda Universal range of Multitite fittings are made of nickel plated brass. The IP 54 rated fittings are available in ISO and Pg thread and in fixed and swivel executions for use with Anaconda Multitite Type FCE-LFHB. The 2 piece fitting is designed to resist corrosion and handle tough operating conditions.

### Material & Construction:

**Construction:** Nickel plated brass fitting, consisting of 2 parts (body and cap).

**Material:** Body and cap are nickel plated brass.

**Temperature:** -55 °C till +260 °C continuous.

**Protection class:** IP 54.

**Colour:** Metal coloured.

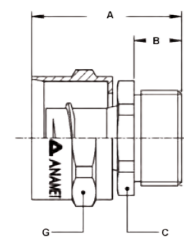

ISO straight fitting, fixed, male, nickel plated brass



THREAD ISO	FCE-LFHB SIZE (DN)	MIN. INTERNAL BORE (MM)	DIMENSIONS IN MM					STANDARD PACKAGE	ARTICLE NUMBER	WEIGHT (KG/100)
			A	B	C	G	E			
M16 x 1,5	16	11,2	30	10	20	21	-	10	260.616.0	2,4
M20 x 1,5	16	11,2	30	10	22	21	-	10	260.617.0	2,8
M20 x 1,5	20	15,2	31	10	24	26	-	10	260.620.0	3,2
M25 x 1,5	25	19,2	37	12	30	30	-	5	260.625.0	5,7
M32 x 1,5	32	25,9	39	13	38	40	-	5	260.632.0	8,4

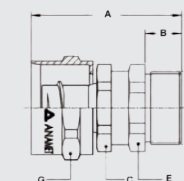

ISO straight fitting, swivel, male, nickel plated brass



THREAD ISO	FCE-LFHB SIZE (DN)	MIN. INTERNAL BORE (MM)	DIMENSIONS IN MM					STANDARD PACKAGE	ARTICLE NUMBER	WEIGHT (KG/100)
			A	B	C	G	E			
M16 x 1,5	16	11,2	39	10	20	21	20	10	261.616.0	4
M20 x 1,5	16	11,2	39	10	20	21	22	10	261.617.0	4,4
M20 x 1,5	20	15,2	41	10	24	26	24	10	261.620.0	5,1
M25 x 1,5	25	19,2	48	12	30	30	30	5	261.625.0	9,1
M32 x 1,5	32	25,9	51	13	38	40	38	5	261.632.0	13,6



## 2 PIECE FITTINGS FOR FCE-LFHB, IP 54, NICKEL PLATED BRASS

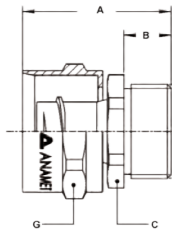

Pg straight fitting, fixed, male, nickel plated brass



THREAD PG	FCE-LFHB SIZE (DN)	MIN. INTERNAL BORE (MM)	DIMENSIONS IN MM					STANDARD PACKAGE	ARTICLE NUMBER	WEIGHT (KG/100)
			A	B	C	G	E			
Pg 11	16	11,2	30	10	20	21	-	10	260.711.0	2,5
Pg 16	20	15,2	31	10	24	26	-	10	260.716.0	3,4
Pg 21	25	19,2	37	12	30	30	-	5	260.721.0	5,8
Pg 29	32	25,9	39	13	38	40	-	5	260.729.0	9,2

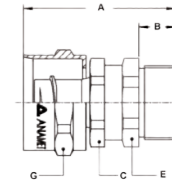

Pg straight fitting, swivel, male, nickel plated brass



THREAD PG	FCE-LFHB SIZE (DN)	MIN. INTERNAL BORE (MM)	DIMENSIONS IN MM					STANDARD PACKAGE	ARTICLE NUMBER	WEIGHT (KG/100)
			A	B	C	G	E			
Pg 11	16	11,2	39	10	20	21	20	10	261.711.0	4,1
Pg 16	20	15,2	41	10	24	26	24	10	261.716.0	5,4
Pg 21	25	19,2	48	12	30	30	30	5	261.721.0	9,5
Pg 29	32	25,9	51	13	38	40	40	5	261.729.0	14,9

# 5 Piece fittings for FCE-LFHB, IP 65, nickel plated brass



Anaconda  
Multitite



## ANACONDA IP 65 NICKEL PLATED BRASS FITTINGS FOR MULTITITE TYPE FCE-LFHB

These fittings are made of nickel plated brass and specially for the Multitite type FCE-LFHB. These IP 65 rated fittings are available in ISO (on request also Pg thread) and in various executions (straight, swivel, elbow and conduit connector) for use with Anaconda Multitite Type FCE-LFHB. This 5 piece fitting is designed to resist corrosion and handle tough operating conditions. The gripping construction on the outside of the braid provides an optimum tensile strength and improved shielding characteristics.

### Material & Construction:

**Construction:** Nickel plated brass fitting, consisting of 5 parts (cap, intermediate body, clamping ring, ferrule and body).

**Material:** Cap, intermediate body and body are nickel plated brass. Ferrule is from passivated brass and clamping ring is from PA 6.

**Temperature:** -45 °C till +105 °C continuous.

**Protection class:** IP 65.

**Colour:** Metal coloured.

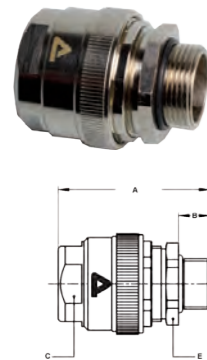

ISO straight fitting, compact, male, nickel plated brass (including connection set)



THREAD ISO	FCE-LFHB SIZE (DN)	MIN. INTERNAL BORE (MM)	DIMENSIONS IN MM					STANDARD PACKAGE	ARTICLE NUMBER	WEIGHT (KG/100)
			A	B	C	D	E			
M16 x 1,5	16	11,2	48	10	24	-	24	10	732.016.4	9,5
M20 x 1,5	16	11,2	48	10	24	-	24	10	732.017.4	9,8
M20 x 1,5	20	15,2	51	10	28	-	27	10	732.020.4	11,5
M25 x 1,5	25	19,2	52	10	34	-	33	5	732.025.4	16
M32 x 1,5	32	25,9	59	12	41	-	42	5	732.032.4	25,5

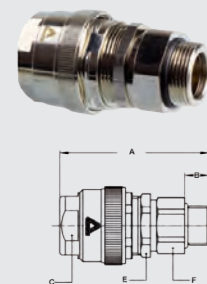

ISO straight swivel fitting, male, nickel plated brass (including connection set)



THREAD ISO	FCE-LFHB SIZE (DN)	MIN. INTERNAL BORE (MM)	DIMENSIONS IN MM					STANDARD PACKAGE	ARTICLE NUMBER	WEIGHT (KG/100)
			A	B	C	E	F			
M16 x 1,5	16	10,7	65	10	24	24	21	10	733.016.4	13,5
M20 x 1,5	20	13,9	68	10	28	27	25	10	733.020.4	16
M25 x 1,5	25	17,4	69	10	34	33	31	5	733.025.4	23
M32 x 1,5	32	23,4	78	12	41	42	38	5	733.032.4	35,5

## 5 PIECE FITTINGS FOR FCE-LFHB, IP 65, NICKEL PLATED BRASS

45° elbow fitting ISO, compact, male, nickel plated brass  
(including connection set)

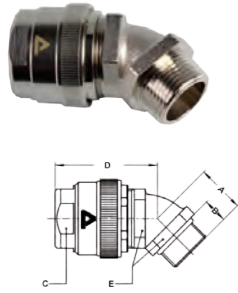

THREAD ISO	FCE-LFHB SIZE (DN)	MIN. INTERNAL BORE (MM)	DIMENSIONS IN MM					STANDARD PACKAGE	ARTICLE NUMBER	WEIGHT (KG/100)
			A	B	C	D	E			
M16 x 1,5	16	11,2	19	10	24	44	22	10	732.416.4	12,5
M20 x 1,5	16	11,2	20	10	24	45	24	10	732.417.4	13,5
M20 x 1,5	20	15,2	21	10	28	50	27	10	732.420.4	15,8
M25 x 1,5	25	19,2	23	10	34	53	33	5	732.425.4	23,5
M32 x 1,5	32	25,9	28	12	41	61	42	5	732.432.4	38,5

90° elbow fitting ISO, compact, male, nickel plated brass  
(including connection set)

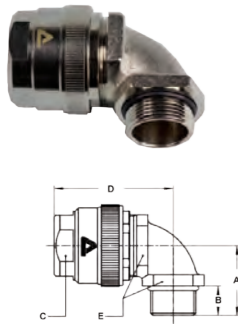

THREAD ISO	FCE-LFHB SIZE (DN)	MIN. INTERNAL BORE (MM)	DIMENSIONS IN MM					STANDARD PACKAGE	ARTICLE NUMBER	WEIGHT (KG/100)
			A	B	C	D	E			
M16 x 1,5	16	11,2	26	10	24	48	22	10	732.916.4	13
M20 x 1,5	16	11,2	26	10	24	49	24	10	732.917.4	14
M20 x 1,5	20	15,2	28	10	28	54	27	10	732.920.4	16,5
M25 x 1,5	25	19,2	32	10	34	61	33	5	732.925.4	24
M32 x 1,5	32	25,9	40	12	41	69	42	5	732.932.4	39

Conduit connector, nickel plated brass  
(including connection set)

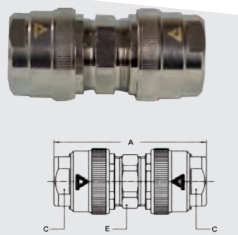

THREAD	FCE-LFHB SIZE (DN)	MIN. INTERNAL BORE (MM)	DIMENSIONS IN MM					STANDARD PACKAGE	ARTICLE NUMBER	WEIGHT (KG/100)
			A	B	C	D	E			
-	16	11,2	75	-	24	-	24	10	785.012.4	18,5
-	20	15,2	84	-	28	-	27	10	785.016.4	21,5
-	25	19,2	88	-	34	-	33	5	785.020.4	29,5
-	32	25,9	96	-	41	-	44	5	785.026.4	48



























Anaconda  
Sealtite



# Anaconda Sealtite

# Conduit selection table

## Anaconda Sealrite®

SEALRITE	MATERIAL	MATERIAL	TEMPERATURE		RESISTANCE (NEN-EN-IEC 61386)			FLEXI- BILITY	RESISTANCE		APPROVALS	PROTEC- TION	PAGE
			Core	Cover	Min.	Max.	Compr.		Impact	Tensile			
<b>EF-M Grey Black</b>	Galvanised steel	PVC RoHS	-20 °C	+70 °C	3 (750N)	4 (6J)	4 (1000N)	++	+++	+++		IP 66 IP 67	3 - 3 3 - 4
<b>EF Grey Black</b>	Galvanised steel	PVC RoHS	-25 °C	+70 °C	4 (1250N)	4 (6J)	4 (1000N)	+++	+++	+++		IP 66 IP 67	3 - 5 3 - 6
<b>OR Black</b>	Galvanised steel	PVC RoHS	-15 °C	+100 °C	4 (1250N)	4 (6J)	4 (1000N)	+++	++++	++++		IP 66 IP 67	3 - 7
<b>OR Blue</b>	Galvanised steel	PVC RoHS	-15 °C	+100 °C	4 (1250N)	4 (6J)	4 (1000N)	+++	++++	++++		IP 66 IP 67	3 - 8
<b>HC Black</b>	Galvanised steel	PVC RoHS	-45 °C	+105 °C	4 (1250N)	4 (6J)	4 (1000N)	+++	++++	++++		IP 66 IP 67	3 - 9
<b>HGX Black</b>	Galvanised steel	TPE RoHS	-55 °C	+145 °C	4 (1250N)	4 (6J)	4 (1000N)	++++	+++	++		IP 66 IP 67	3 - 10
<b>HFX Black</b>	Galvanised steel	TPU Halogen free RoHS	-55 °C	+105 °C	4 (1250N)	4 (6J)	4 (1000N)	++++	++++	++++		IP 66 IP 67	3 - 11
<b>HFX Blue</b>	Galvanised steel	TPU Halogen free RoHS	-55 °C	+105 °C	4 (1250N)	4 (6J)	4 (1000N)	++++	++++	++++		IP 66 IP 67	3 - 12
<b>HFX-VO Black</b>	Galvanised steel	TPU Halogen free RoHS	-50 °C	+105 °C	4 (1250N)	4 (6J)	4 (1000N)	++++	++++	++++	 	IP 66 IP 67	3 - 13
<b>ZHLS Black</b>	Galvanised steel	TPO Halogen free RoHS	-25 °C	+80 °C	4 (1250N)	4 (6J)	4 (1000N)	+++	++++	++	  	IP 66 IP 67	3 - 14
<b>HTDL Black</b>	Galvanised steel	PVC RoHS	-45 °C	+105 °C	4 (1250N)	4 (6J)	4 (1000N)	+++	++++	++++	  	IP 66 IP 67	3 - 15
<b>HTUA Grey</b>	Galvanised steel	PVC RoHS	-45 °C	+105 °C	4 (1250N)	4 (6J)	4 (1000N)	+++	++++	++++	  	IP 66 IP 67	3 - 16
<b>ZHUA Black</b>	Galvanised steel	TPU Halogen free RoHS	-50 °C	+105 °C	4 (1250N)	4 (6J)	4 (1000N)	++++	++++	++++	   	IP 66 IP 67	3 - 17
<b>CW Blue</b>	Galvanised steel	PVC RoHS	-40 °C	+80 °C	4 (1250N)	4 (6J)	4 (1000N)	+++	++++	++++	  	IP 66 IP 67	3 - 18



# Anaconda Sealrite conduit

## TYPE EF-M GREY

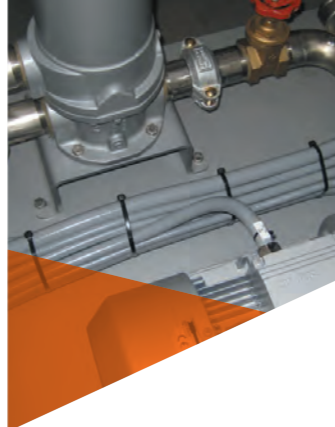
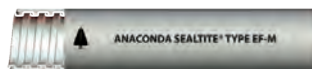

### FLEXIBLE, GENERAL USE CONDUIT WITH GOOD MECHANICAL PROTECTION

Type EF-M features a galvanised steel core and smooth PVC cover. The conduit is designed to provide good mechanical protection of cables and wires on equipment, machines, enclosures and control boxes used in the woodcutting, packaging and metalworking industries etc. The conduit displays good flexibility in both static and semi-dynamic applications.

#### Material & Construction:

**Construction:** Hot dipped galvanised steel core, square locked without cord packing, thick smooth thermoplastic cover (PVC compound).

**Cover specifications:** PVC, lead-free according to RoHS, suitable for burial installation.

**Temperature:** -20 °C till +70 °C, intermittent up to +80 °C.

**Colour:** Grey (black is also available).

#### Classification according to NEN-EN-IEC 61386:

**Compression resistance:** Class 3, Medium (750 N).

**Impact resistance:** Class 4, Heavy (6 J).

**Tensile strength:** Class 4, Heavy (1000 N).

**Protection class:** IP 66 / 67 (dust-proof, water-tight).



Square locked from 3/8" - 2"

Anaconda  
Sealrite

SEALRITE	DIAMETRE		BENDING RADIUS (CL)		STANDARD CARTON		SMALL CARTON		REEL		WEIGHT (kg/m)
	Size (inch)	Inside (mm)	Outside (mm)	Static (mm)	Dynamic (mm)	Metre	Article No. grey	Metre	Article No. grey	Metre	
1/4"	-	-	-	-	-	-	-	-	-	-	-
5/16"	-	-	-	-	-	-	-	-	-	-	-
3/8"	12,6	17,8	60	100	75	314.012.1	-	-	240	314.012.5	0,2
1/2"	16	21,1	75	125	60	314.016.1	-	-	150	314.016.5	0,3
3/4"	21	26,4	90	160	30	314.020.1	-	-	150	314.020.5	0,5
1"	26,5	33,1	120	200	30	314.026.1	-	-	120	314.026.5	0,7
1 1/4"	35,1	41,8	150	240	15	314.035.1	-	-	75	314.035.5	0,9
1 1/2"	40,3	47,8	200	290	15	314.040.1	-	-	45	314.040.5	1,25
2"	51,6	59,9	250	350	15	314.050.1	-	-	30	314.050.5	1,75

The fittings for Sealrite are outlined in chapter 5 Sealrite Fittings

SEALRITE	1/4"	5/16"	3/8"	1/2"	3/4"	1"	1 1/4"	1 1/2"	2"	2 1/2"	3"	4"
ISO	M10 - M12	M16 - M20	M16 - M20	M20	M25	M32	M40	M50 - M63	M50 - M63	M75	M90	-
Pg	7	09 - 11	11 - 13,5	16	21	29	36	42	48	-	-	-
NPT	-	-	1/2"	1/2"	3/4"	1"	1 1/4"	1 1/2"	2"	2 1/2"	3"	4"

# Anaconda Sealbite conduit

## TYPE EF-M BLACK



### FLEXIBLE, GENERAL USE CONDUIT WITH GOOD MECHANICAL PROTECTION

Type EF-M features a galvanised steel core and smooth PVC cover. The conduit is designed to provide good mechanical protection of cables and wires on equipment, machines, enclosures and control boxes used in the woodcutting, packaging and metalworking industries etc. The conduit displays good flexibility in both static and semi-dynamic applications.

#### Material & Construction:

**Construction:** Hot dipped galvanised steel core, square locked without cord packing, thick smooth thermoplastic cover (PVC compound).

**Cover specifications:** PVC, lead-free according to RoHS, sunlight and UV resistant, suitable for outdoor use and burial installation.

**Temperature:** -20 °C till +70 °C, intermittent up to +80 °C.

**Colour:** Black (grey is also available).

#### Classification according to NEN-EN-IEC 61386:

**Compression resistance:** Class 3, Medium (750 N).

**Impact resistance:** Class 4, Heavy (6 J).

**Tensile strength:** Class 4, Heavy (1000 N).

**Protection class:** IP 66 / 67 (dust-proof, water-tight).



Square locked from 3/8" - 2"

SEALBITE	DIAMETRE		BENDING RADIUS (CL)		STANDARD CARTON		SMALL CARTON		REEL		WEIGHT (kg/m)
	Size (inch)	Inside (mm)	Outside (mm)	Static (mm)	Dynamic (mm)	Metre	Article No. black	Metre	Article No. black	Metre	
1/4"	-	-	-	-	-	-	-	-	-	-	-
5/16"	-	-	-	-	-	-	-	-	-	-	-
3/8"	12,6	17,8	60	100	75	310.012.1	-	-	240	310.012.5	0,2
1/2"	16	21,1	75	125	60	310.016.1	-	-	150	310.016.5	0,3
3/4"	21	26,4	90	160	30	310.020.1	-	-	150	310.020.5	0,5
1"	26,5	33,1	120	200	30	310.026.1	-	-	120	310.026.5	0,7
1 1/4"	35,1	41,8	150	240	15	310.035.1	-	-	75	310.035.5	0,9
1 1/2"	40,3	47,8	200	290	15	310.040.1	-	-	45	310.040.5	1,25
2"	51,6	59,9	250	350	15	310.050.1	-	-	30	310.050.5	1,75

The fittings for Sealbite are outlined in chapter 5 Sealbite Fittings

SEALBITE	1/4"	5/16"	3/8"	1/2"	3/4"	1"	1 1/4"	1 1/2"	2"	2 1/2"	3"	4"
ISO	M10 - M12	M16 - M20	M16 - M20	M20	M25	M32	M40	M50 - M63	M50 - M63	M75	M90	-
PG	7	09 - 11	11 - 13,5	16	21	29	36	42	48	-	-	-
NPT	-	-	1/2"	1/2"	3/4"	1"	1 1/4"	1 1/2"	2"	2 1/2"	3"	4"

# Anaconda Sealbite conduit

## TYPE EF GREY



### ROBUST, FLEXIBLE, GENERAL USE CONDUIT WITH GOOD MECHANICAL PROTECTION

Type EF features a galvanised steel core and smooth PVC cover. The conduit provides very good mechanical protection of cables and wires on machines and equipment connected to enclosures and control boxes in a wide range of industries such as packaging machines used in paper recycling industry and other transport systems. The conduit displays good flexibility in both static and semi-dynamic applications.

#### Material & Construction:

**Construction:** Hot dipped galvanised steel core, square locked with cord packing, thick smooth thermoplastic cover (PVC compound).

Size 1/4" and from 1.1/2" till 4", a fully inter locked profile is used. From 2.1/2" till 4" the conduit has a UL approval (type EFST / UA).

**Cover specifications:** PVC, lead-free according to RoHS, suitable for burial installation.

**Temperature:** -25 °C till +70 °C, intermittent up to +90 °C.

**Colour:** Grey (black is also available).

#### Classification according to NEN-EN-IEC 61386:

**Compression resistance:** Class 4, Heavy (1250 N).

**Impact resistance:** Class 4, Heavy (6 J).

**Tensile strength:** Class 4, Heavy (1000 N).

**Protection class:** IP 66 / 67 (dust-proof, water-tight).



Square locked from 5/16" - 1.1/4"



Inter locked for size 1/4", 1.1/2" - 6"

Anaconda  
Sealbite

SEALTITE	DIAMETRE		BENDING RADIUS (CL)		STANDARD CARTON		SMALL CARTON		REEL		WEIGHT
Size (inch)	Inside (mm)	Outside (mm)	Static (mm)	Dynamic (mm)	Metre	Article No. grey	Metre	Article No. grey	Metre	Article No. grey	(kg/m)
1/4"	6,4	11,5	40	50	50	311.006.1	-	-	-	-	0,15
5/16"	10,1	14,4	50	65	50	311.010.1	10	311.010.3	-	-	0,2
3/8"	12,6	17,8	60	85	75	311.012.1	10	311.012.3	250	311.012.5	0,3
1/2"	16	21,1	75	110	60	311.016.1	10	311.016.3	150	311.016.5	0,4
3/4"	21	26,4	90	140	50	311.020.1	10	311.020.3	120	311.020.5	0,55
1"	26,5	33,1	120	170	30	311.026.1	10	311.026.3	90	311.026.5	0,75
1.1/4"	35,1	41,8	135	215	30	311.035.1	10	311.035.3	60	311.035.5	1
1.1/2"	40,3	47,8	165	250	15	311.040.1	-	-	45	311.040.5	1,55
2"	51,6	59,9	210	300	15	311.050.1	-	-	30	311.050.5	2,15
2.1/2"	63,3	72,6	280	375	7,5	311.063.1	-	-	-	-	2,8
3"	78,4	88,4	425	530	7,5	311.075.1	-	-	-	-	3,7
4"	102,1	113,8	490	600	7,5	311.100.1	-	-	-	-	4,9
5"	127,1	140,5	630	750	7,5	311.125.1	-	-	-	-	7,9
6"	153,5	167,5	850	1000	7,5	311.150.1	-	-	-	-	9,9

The fittings for Sealbite are outlined in chapter 5 Sealbite Fittings

SEALTITE	1/4"	5/16"	3/8"	1/2"	3/4"	1"	1.1/4"	1.1/2"	2"	2.1/2"	3"	4"
ISO	M10 - M12	M16 - M20	M16 - M20	M20	M25	M32	M40	M50 - M63	M50 - M63	M75	M90	-
Pg	7	09 - 11	11 - 13,5	16	21	29	36	42	48	-	-	-
NPT	-	-	1/2"	1/2"	3/4"	1"	1.1/4"	1.1/2"	2"	2.1/2"	3"	4"

# Anaconda Sealtite conduit

## TYPE EF BLACK



### ROBUST, FLEXIBLE, GENERAL USE CONDUIT WITH GOOD MECHANICAL PROTECTION

Type EF features a galvanised steel core and smooth PVC cover. The conduit provides very good mechanical protection of cables and wires on machines and equipment connected to enclosures and control boxes in a wide range of industries such as packaging machines used in paper recycling industry and other transport systems. The conduit displays good flexibility in both static and semi-dynamic applications.

#### Material & Construction:

**Construction:** Hot dipped galvanised steel core, square locked with cord packing, thick smooth thermoplastic cover (PVC compound). Size 1/4" and from 1.1/2" till 4", a fully inter locked profile is used. From 2.1/2" till 4" the conduit has a UL approval (type EFST / UA).

**Cover specifications:** PVC, lead-free according to RoHS, sunlight and UV resistant, suitable for outdoor use and burial installation.

**Temperature:** -25 °C till +70 °C, intermittent up to +90 °C.

**Colour:** Black (grey is also available).



#### Classification according to NEN-EN-IEC 61386:

**Compression resistance:** Class 4, Heavy (1250 N).

**Impact resistance:** Class 4, Heavy (6 J).

**Tensile strength:** Class 4, Heavy (1000 N).

**Protection class:** IP 66 / 67 (dust-proof, water-tight).



Square locked from 5/16" - 1.1/4"



Inter locked for size 1/4", 1.1/2" - 6"

SEALTITE	DIAMETRE		BENDING RADIUS (CL)		STANDARD CARTON		SMALL CARTON		REEL		WEIGHT
Size (inch)	Inside (mm)	Outside (mm)	Static (mm)	Dynamic (mm)	Metre	Article No. black	Metre	Article No. black	Metre	Article No. black	(kg/m)
1/4"	6,4	11,5	40	50	50	315.006.1	-	-	-	-	0,15
5/16"	10,1	14,4	50	65	50	315.010.1	10	315.010.3	-	-	0,2
3/8"	12,6	17,8	60	85	75	315.012.1	10	315.012.3	250	315.012.5	0,3
1/2"	16	21,1	75	110	60	315.016.1	10	315.016.3	150	315.016.5	0,4
3/4"	21	26,4	90	140	50	315.020.1	10	315.020.3	120	315.020.5	0,55
1"	26,5	33,1	120	170	30	315.026.1	10	315.026.3	90	315.026.5	0,75
1.1/4"	35,1	41,8	150	215	30	315.035.1	10	315.035.3	60	315.035.5	1
1.1/2"	40,3	47,8	200	250	15	315.040.1	-	-	45	315.040.5	1,55
2"	51,6	59,9	250	300	15	315.050.1	-	-	30	315.050.5	2,15
2.1/2"	63,3	72,6	280	375	7,5	315.063.1	-	-	-	-	2,8
3"	78,4	88,4	425	530	7,5	315.075.1	-	-	-	-	3,7
4"	102,1	113,8	490	600	7,5	315.100.1	-	-	-	-	4,9
5"	127,1	140,6	600	750	7,5	315.125.1	-	-	-	-	7,9
6"	153,5	167,5	730	1000	7,5	315.150.1	-	-	-	-	9,9

The fittings for Sealtite are outlined in chapter 5 Sealtite Fittings

SEALTITE	1/4"	5/16"	3/8"	1/2"	3/4"	1"	1.1/4"	1.1/2"	2"	2.1/2"	3"	4"
ISO	M10 - M12	M16 - M20	M16 - M20	M20	M25	M32	M40	M50 - M63	M50 - M63	M75	M90	-
Pg	7	09 - 11	11 - 13,5	16	21	29	36	42	48	-	-	-
NPT	-	-	1/2"	1/2"	3/4"	1"	1.1/4"	1.1/2"	2"	2.1/2"	3"	4"

# Anaconda Sealrite conduit

## TYPE OR BLACK



Anaconda  
Sealrite

### ROBUST, OIL & GREASE RESISTANT

Type OR is a robust conduit with a galvanised steel core and thick, smooth oil resistant PVC cover. A construction that provides good mechanical protection of cables and resistance to aggressive oils and greases. When exposed to these substances, the conduit retains its flexibility and does not stiffen or rupture. Type OR is used in many applications including machines where metalworking fluids are used, on diesel-engines, generator-sets and machines and equipment in the metal, paper, chemical and petrochemical industry.

#### Material & Construction:

**Construction:** Hot dipped galvanised steel core, square locked with cord packing, thick smooth thermoplastic cover (PVC compound). Size ¼" and from 1.1/2" up to 4", a fully inter locked profile is used.

to RoHS, sunlight and UV resistant, suitable for outside installation. The cover is good resistant against oil and grease.

**Temperature:** -15 °C till +100 °C, intermittent up to +120 °C.

**Cover specifications:** PVC, lead-free according

**Colour:** Black (blue is also available).



#### Classification according to NEN-EN-IEC 61386:

**Compression resistance:** Class 4, Heavy (1250 N).

**Impact resistance:** Class 4, Heavy (6 J).

**Tensile strength:** Class 4, Heavy (1000 N).

**Protection class:** IP 66 / 67 (dust-proof, water-tight).



Square locked from 5/16" - 1.1/4"



Inter locked for size 1/4", 1.1/2" - 6"

SEALRITE	DIAMETRE		BENDING RADIUS (CL)		STANDARD CARTON		SMALL CARTON		REEL		WEIGHT (Kg/m)
	Size (inch)	Inside (mm)	Outside (mm)	Static (mm)	Dynamic (mm)	Metre	Article No. black	Metre	Article No. black	Metre	
1/4"	6,4	11,5	40	50	50	320.006.1	-	-	-	-	0,15
5/16"	10,1	14,4	50	65	50	320.010.1	10	320.010.3	-	-	0,2
3/8"	12,6	17,8	60	85	75	320.012.1	10	320.012.3	250	320.012.5	0,3
1/2"	16	21,1	75	110	60	320.016.1	10	320.016.3	150	320.016.5	0,4
3/4"	21	26,4	90	140	50	320.020.1	10	320.020.3	120	320.020.5	0,55
1"	26,5	33,1	120	170	30	320.026.1	10	320.026.3	90	320.026.5	0,75
1.1/4"	35,1	41,8	150	215	30	320.035.1	10	320.035.3	60	320.035.5	1
1.1/2"	40,3	47,8	200	250	15	320.040.1	-	-	45	320.040.5	1,55
2"	51,6	59,9	250	300	15	320.050.1	-	-	30	320.050.5	2,15
2.1/2"	63,3	72,6	280	375	15	320.063.1	-	-	-	-	2,8
3"	78,4	88,4	425	530	7,5	320.075.1	-	-	-	-	3,7
4"	102,1	113,8	490	600	7,5	320.100.1	-	-	-	-	4,9

The fittings for Sealrite are outlined in chapter 5 Sealrite Fittings

SEALRITE	1/4"	5/16"	3/8"	1/2"	3/4"	1"	1.1/4"	1.1/2"	2"	2.1/2"	3"	4"
ISO	M10 - M12	M16 - M20	M16 - M20	M20	M25	M32	M40	M50 - M63	M50 - M63	M75	M90	-
Pg	7	09 - 11	11 - 13,5	16	21	29	36	42	48	-	-	-
NPT	-	-	1/2"	1/2"	3/4"	1"	1.1/4"	1.1/2"	2"	2.1/2"	3"	4"



# Anaconda Sealrite conduit

## TYPE OR BLUE



### ROBUST, OIL & GREASE RESISTANT

Type OR is a robust conduit with a galvanised steel core and thick, smooth oil resistant PVC cover. A construction that provides good mechanical protection of cables and resistance to aggressive oils and greases. When exposed to these substances, the conduit retains its flexibility and does not stiffen or rupture. Type OR is used in many applications including machines where metalworking fluids are used, on diesel-engines, generator-sets and machines and equipment in the metal, paper, chemical and petrochemical industry.

#### Material & Construction:

**Construction:** Hot dipped galvanised steel core, square locked with cord packing, thick smooth thermoplastic cover (PVC compound).

**Temperature:** -15 °C till +100 °C, intermittent up to +120 °C.

**Colour:** Blue (black is also available).

**Cover specifications:** PVC, lead-free according to RoHS, sunlight and UV resistant, suitable for outside installation. The cover is good resistant against oil and grease.

#### Classification according to NEN-EN-IEC 61386:

**Compression resistance:** Class 4, Heavy (1250 N).

**Impact resistance:** Class 4, Heavy (6 J).

**Tensile strength:** Class 4, Heavy (1000 N).

**Protection class:** IP 66 / 67 (dust-proof, water-tight).



Square locked from 5/16" - 1.1/4"

SEALRITE	DIAMETRE		BENDING RADIUS (CL)		STANDARD CARTON		SMALL CARTON		REEL		WEIGHT (kg/m)
	Size (inch)	Inside (mm)	Outside (mm)	Static (mm)	Dynamic (mm)	Metre	Article No. blue	Metre	Article No. blue	Metre	
3/8"	12,6	17,8	60	85	30	322.012.1	-	-	-	-	0,3
1/2"	16	21,1	75	110	30	322.016.1	-	-	-	-	0,4
3/4"	21	26,4	90	140	30	322.020.1	-	-	-	-	0,55
1"	26,5	33,1	120	170	30	322.026.1	-	-	-	-	0,75
1.1/4"	35,1	41,8	150	215	30	322.035.1	-	-	-	-	1

The fittings for Sealrite are outlined in chapter 5 Sealrite Fittings

SEALRITE	1/4"	5/16"	3/8"	1/2"	3/4"	1"	1.1/4"	1.1/2"	2"	2.1/2"	3"	4"
ISO	M10 - M12	M16 - M20	M16 - M20	M20	M25	M32	M40	M50 - M63	M50 - M63	M75	M90	-
Pg	7	09 - 11	11 - 13,5	16	21	29	36	42	48	-	-	-
NPT	-	-	1/2"	1/2"	3/4"	1"	1.1/4"	1.1/2"	2"	2.1/2"	3"	4"

# Anaconda Sealrite conduit

## TYPE HC BLACK



Anaconda  
Sealrite

### ROBUST, WIDE OPERATING TEMPERATURE RANGE

Type HC is a robust conduit with a galvanised steel core and a thick, smooth heat resistant PVC cover. The conduit retains its functional integrity equally good in freezing and extremely hot conditions. Type HC is used in train warning systems, transformers, transport systems, woodcutting machines, sewing machines, security systems in energy plants, and equipment and cabinets in the chemical, ceramic and construction industries.

#### Material & Construction:

**Construction:** Hot dipped galvanised steel core, square locked with cord packing, thick smooth thermoplastic cover (PVC compound). Size 1/4" and from 1 1/2" up to 4", a fully inter locked profile is used.

**Cover specifications:** High and low temperature resistant PVC, lead-free according to RoHS,

sunlight and UV resistant, suitable for outside installation. The cover is good resistant against oil and grease.

**Temperature:** -45 °C till +105 °C, intermittent up to +120 °C.

**Colour:** Black.



Square locked from 5/16" - 1 1/4"



Inter locked for size 1/4", 1 1/2" - 4"

#### Classification according to NEN-EN-IEC 61386:

**Compression resistance:** Class 4, Heavy (1250 N).

**Impact resistance:** Class 4, Heavy (6 J).

**Tensile strength:** Class 4, Heavy (1000 N).

**Protection class:** IP 66 / 67 (dust-proof, water-tight).

SEALRITE	DIAMETRE		BENDING RADIUS (CL)		STANDARD CARTON		SMALL CARTON		REEL		WEIGHT
	Size (inch)	Inside (mm)	Outside (mm)	Static (mm)	Dynamic (mm)	Metre	Article No. black	Metre	Article No. black	Metre	
1/4"	6,4	11,5	40	50	50	317.006.1	-	-	-	-	0,15
5/16"	10,1	14,4	50	65	50	317.010.1	10	317.010.3	-	-	0,2
3/8"	12,6	17,8	60	85	75	317.012.1	10	317.012.3	250	317.012.5	0,3
1/2"	16	21,1	75	110	60	317.016.1	10	317.016.3	150	317.016.5	0,4
3/4"	21	26,4	90	140	50	317.020.1	10	317.020.3	120	317.020.5	0,55
1"	26,5	33,1	120	170	30	317.026.1	10	317.026.3	90	317.026.5	0,75
1 1/4"	35,1	41,8	135	215	30	317.035.1	10	317.035.3	60	317.035.5	1
1 1/2"	40,3	47,8	165	250	15	317.040.1	-	-	45	317.040.5	1,55
2"	51,6	59,9	210	300	15	317.050.1	-	-	30	317.050.5	2,15
2 1/2"	63,3	72,6	280	375	7,5	317.063.1	-	-	-	-	2,8
3"	78,4	88,4	425	530	7,5	317.075.1	-	-	-	-	3,7
4"	102,1	113,8	490	600	7,5	317.100.1	-	-	-	-	4,9

The fittings for Sealrite are outlined in chapter 5 Sealrite Fittings

SEALRITE	1/4"	5/16"	3/8"	1/2"	3/4"	1"	1 1/4"	1 1/2"	2"	2 1/2"	3"	4"
ISO	M10 - M12	M16 - M20	M16 - M20	M20	M25	M32	M40	M50 - M63	M50 - M63	M75	M90	-
Pg	7	09 - 11	11 - 13,5	16	21	29	36	42	48	-	-	-
NPT	-	-	1/2"	1/2"	3/4"	1"	1 1/4"	1 1/2"	2"	2 1/2"	3"	4"

# Anaconda Sealbite conduit

## TYPE HCX BLACK



### ROBUST, VERY WIDE OPERATING TEMPERATURE RANGE

Type HCX is a very robust conduit that features a galvanised steel core and a thick, smooth TPE cover that is very temperature resistant. The conduit retains its functional integrity equally good when exposed to freezing and extreme hot temperatures. Robust, yet very flexible, type HCX is used in transformers, offshore applications, steelworks, foundries, machine building and many outdoor installations where temperature and humidity are critical.

#### Material & Construction:

**Construction:** Hot dipped galvanised steel core, square locked with cord packing, thick smooth Thermo-Plastic Elastomer (TPE compound) cover. From 1.1/2" a fully inter locked profile will be used.

**Temperature:** -55 °C till +145 °C, intermittent up to +160 °C.

**Colour:** Black.

**Cover specifications:** TPE, lead-free according to RoHS, sunlight and UV resistant. Suitable for outside installation.



Square locked from 3/8" - 1.1/4"



Inter locked for size 1.1/2" and 2"

#### Classification according to NEN-EN-IEC 61386:

**Compression resistance:** Class 4, Heavy (1250 N).

**Impact resistance:** Class 4, Heavy (6 J).

**Tensile strength:** Class 4, Heavy (1000 N).

**Protection class:** IP 66 / 67 (dust-proof, water-tight).

SEALTITE	DIAMETRE		BENDING RADIUS (CL)		STANDARD CARTON		SMALL CARTON		REEL		WEIGHT (kg/m)
	Size (inch)	Inside (mm)	Outside (mm)	Static (mm)	Dynamic (mm)	Metre	Article No. black	Metre	Article No. black	Metre	
3/8"	12,6	17,8	60	85	30	326.012.1	10	326.012.3	250	326.012.5	0,30
1/2"	16	21,1	75	110	30	326.016.1	10	326.016.3	150	326.016.5	0,4
3/4"	21	26,4	90	140	30	326.020.1	10	326.020.3	120	326.020.5	0,55
1"	26,5	33,1	120	170	30	326.026.1	10	326.026.3	90	326.026.5	0,75
1.1/4"	35,1	41,8	135	215	15	326.035.1	-	-	60	326.035.5	1
1.1/2"	40,3	47,8	165	250	15	326.040.1	-	-	45	326.040.5	1,55
2"	51,6	59,9	210	300	15	326.050.1	-	-	30	326.050.5	2,15

The fittings for Sealbite are outlined in chapter 5 Sealbite Fittings

SEALTITE	1/4"	5/16"	3/8"	1/2"	3/4"	1"	1.1/4"	1.1/2"	2"	2.1/2"	3"	4"
ISO	M10 - M12	M16 - M20	M16 - M20	M20	M25	M32	M40	M50 - M63	M50 - M63	M75	M90	-
Pg	7	09 - 11	11 - 13,5	16	21	29	36	42	48	-	-	-
NPT	-	-	1/2"	1/2"	3/4"	1"	1.1/4"	1.1/2"	2"	2.1/2"	3"	4"

# Anaconda Sealrite conduit



## TYPE HFX BLACK



### ROBUST, HALOGEN FREE, VERY FLEXIBLE, FLAME RETARDANT AND CHEMICAL RESISTANT

Type HFX is a robust conduit with a galvanised steel core and a thick, smooth TPU cover that is highly resistant to chemicals, is Halogen free and flame retardant. It is a very flexible conduit designed for dynamic applications where frequent movement occurs. When exposed to movement, the conduit retains its flexibility and integrity even at low operating temperatures; it does not stiffen or rupture. Type HFX meets the stringent requirements of the rail and subway infrastructure, train signalling, rolling stock, marine, petrochemical and chemical industries as well as closed areas like airports, tunnels and subway stations.

#### Material & Construction:

**Construction:** Hot dipped galvanised steel core, square locked with cord packing, thick smooth Thermoplastic Polyurethane (TPU compound) cover. Size 1/4" and from 1 1/2" a fully inter locked profile is used.

**Cover specifications:** Polyurethane, lead-free according to RoHS, sunlight and UV resistant, suitable for outside installation. The cover is resistant against oil and grease.

**Temperature:** -55 °C till +105 °C, intermittent up to +125 °C.

**Colour:** Black (blue is also available).



Square locked from 5/16" - 1 1/4"



Inter locked for size 1/4", 1 1/2" - 2"

#### Classification according to NEN-EN-IEC 61386:

**Compression resistance:** Class 4, Heavy (1250 N).

**Impact resistance:** Class 4, Heavy (6 J).

**Tensile strength:** Class 4, Heavy (1000 N).

**Protection class:** IP 66 / 67 (dust-proof, water-tight).

SEALRITE	DIAMETRE		BENDING RADIUS (CL)		STANDARD CARTON		SMALL CARTON		REEL		WEIGHT (kg/m)
	Size (inch)	Inside (mm)	Outside (mm)	Static (mm)	Dynamic (mm)	Metre	Article No. black	Metre	Article No. black	Metre	
1/4"	6,4	11,5	40	50	30	331.006.1	-	-	-	-	0,15
5/16"	10,1	14,4	50	65	30	331.010.1	10	331.010.3	250	331.010.5	0,2
3/8"	12,6	17,8	60	85	30	331.012.1	10	331.012.3	250	331.012.5	0,3
1/2"	16	21,1	75	110	30	331.016.1	10	331.016.3	150	331.016.5	0,4
3/4"	21	26,4	90	140	30	331.020.1	10	331.020.3	120	331.020.5	0,5
1"	26,5	33,1	120	170	30	331.026.1	10	331.026.3	90	331.026.5	0,7
1 1/4"	35,1	41,8	135	215	15	331.035.1	-	-	60	331.035.5	1,15
1 1/2"	40,3	47,8	165	250	15	331.040.1	-	-	-	-	1,5
2"	51,6	59,9	210	300	15	331.050.1	-	-	-	-	2,15

The fittings for Sealrite are outlined in chapter 5 Sealrite Fittings

SEALRITE	1/4"	5/16"	3/8"	1/2"	3/4"	1"	1 1/4"	1 1/2"	2"	2 1/2"	3"	4"
ISO	M10 - M12	M16 - M20	M16 - M20	M20	M25	M32	M40	M50 - M63	M50 - M63	M75	M90	-
Pg	7	09 - 11	11 - 13,5	16	21	29	36	42	48	-	-	-
NPT	-	-	1/2"	1/2"	3/4"	1"	1 1/4"	1 1/2"	2"	2 1/2"	3"	4"

Anaconda  
Sealrite

# Anaconda Sealbite conduit



## TYPE HFX BLUE



### ROBUST, HALOGEN FREE, VERY FLEXIBLE, FLAME RETARDANT AND CHEMICAL RESISTANT

Type HFX Blue is a robust conduit with a galvanised steel core and a TPU cover that is highly resistant to chemicals, is halogen free and is flame retardant. It is a very flexible conduit designed for dynamic applications where frequent movement occurs. When exposed to movement, the conduit retains its flexibility and integrity even at low operating temperatures: it does not stiffen or rupture. Type HFX Blue can be used to protect cables and wires in hazardous areas, including low energy ATEX Ex i components, and equipment and cabinets in the oil & gas, chemical and petro-chemical industries etc.

#### Material & Construction:

**Construction:** Hot dipped galvanised steel core, square locked with cord packing, thick smooth Thermoplastic Polyurethane (TPU compound) cover. Size 1/4" and from 1.1/2" a fully inter locked profile is used.

**Cover specifications:** Polyurethane, lead-free according to RoHS, sunlight and UV resistant, suitable for outside installation. The cover is resistant against oil and grease.

**Temperature:** -55 °C till +105 °C, intermittent up to +125 °C.

**Colour:** Blue (black is also available).



#### Classification according to NEN-EN-IEC 61386:

**Compression resistance:** Class 4, Heavy (1250 N).

**Impact resistance:** Class 4, Heavy (6 J).

**Tensile strength:** Class 4, Heavy (1000 N).

**Protection class:** IP 66 / 67 (dust-proof, water-tight).



Square locked from 3/8" - 1.1/4"



Inter locked for size 1.1/2" and 2"

SEALTITE	DIAMETRE		BENDING RADIUS (CL)		STANDARD CARTON		SMALL CARTON		REEL		WEIGHT	
	Size (inch)	Inside (mm)	Outside (mm)	Static (mm)	Dynamic (mm)	Metre	Article No. blue	Metre	Article No. blue	Metre		Article No. blue
	3/8"	12,6	17,8	60	85	30	335.212.1	-	-	-	-	0,3
	1/2"	16	21,1	75	110	30	335.216.1	-	-	-	-	0,4
	3/4"	21	26,4	90	140	30	335.220.1	-	-	-	-	0,5
	1"	26,5	33,1	120	170	30	335.226.1	-	-	-	-	0,7
	1.1/4"	35,1	41,8	135	215	15	335.235.1	-	-	-	-	1,15
	1.1/2"	40,3	47,8	165	250	15	335.240.1	-	-	-	-	1,5
	2"	51,6	59,9	210	300	15	335.250.1	-	-	-	-	2,15

The fittings for Sealbite are outlined in chapter 5 Sealbite Fittings

SEALTITE	1/4"	5/16"	3/8"	1/2"	3/4"	1"	1.1/4"	1.1/2"	2"	2.1/2"	3"	4"
ISO	M10 - M12	M16 - M20	M16 - M20	M20	M25	M32	M40	M50 - M63	M50 - M63	M75	M90	-
Pg	7	09 - 11	11 - 13,5	16	21	29	36	42	48	-	-	-
NPT	-	-	1/2"	1/2"	3/4"	1"	1.1/4"	1.1/2"	2"	2.1/2"	3"	4"



# Anaconda Sealrite conduit

## TYPE HFX-VO



### ROBUST, HALOGEN FREE, VERY FLEXIBLE, WIDE TEMPERATURE RANGE AND FLAME RETARDANT

Type HFX-VO features a galvanised steel core with a thick, smooth TPU cover which is Halogen free and flame retardant and meets the smoke, fire and toxicity requirements of EN 45545-2, NFPA 130, ASTM E162, E662 and BSS 7239 standards. Type HFX-VO is a very robust conduit that retains its flexibility at low temperatures and changing levels of humidity. The conduit is used to mechanically protect brake sensor, jumper, auto coupler, pantograph cables that are constantly exposed to frequent movement, vibration, stone splash, snow, ice and dirt ballast etc.

#### Material & Construction:

**Construction:** Hot dipped galvanised steel core, square locked with cord packing, thick smooth Thermoplastic Polyurethane (VO-rated TPU) cover.

**Cover specifications:** VO-rated Polyurethane, lead-free according to RoHS, sunlight and UV resistant, suitable for outside installation.

**Special approvals, flame properties according to:**

- EN 45545-2 (2013):  
R22 (interior equipment) class HL1 and HL2  
R23 (exterior equipment) class HL1 and HL2.  
(Average results: CI/Tnlp = 0,19 , Ds max = 262 and LOI = 31,6).

- EN ISO 11925-2: passes the Allumability test at 30 sec.

**Flame property tests:** Official tests (VTEC Laboratories Inc.) indicate that the Poly-Uretane used in HFX-VO meets the requirements for NFPA 130, ASTM E162, ASTM E662 and BSS 7239.

**Temperature:** -50 °C till +105 °C, intermittent up to +125 °C.

**Colour:** Black.



Square locked from 5/16" - 1 1/4"



Inter locked for size 1 1/2" - 2"

Anaconda  
Sealrite

SEALRITE	DIAMETRE		BENDING RADIUS (CL)		STANDARD CARTON		SMALL CARTON		REEL		WEIGHT (kg/m)
	Size (inch)	Inside (mm)	Outside (mm)	Static (mm)	Dynamic (mm)	Metre	Article No. black	Metre	Article No. black	Metre	
5/16"	10,1	14,4	50	65	30	348.010.1	-	-	-	-	0,2
3/8"	12,6	17,8	60	85	30	348.012.1	-	-	-	-	0,3
1/2"	16	21,1	75	110	30	348.016.1	-	-	-	-	0,4
3/4"	21	26,4	90	140	30	348.020.1	-	-	-	-	0,55
1"	26,5	33,1	120	170	30	348.026.1	-	-	-	-	0,75
1 1/4"	35,1	41,8	135	215	15	348.035.1	-	-	-	-	1
1 1/2"	40,3	47,8	165	250	15	348.040.1	-	-	-	-	1,55
2"	51,6	59,9	210	300	15	348.050.1*	-	-	-	-	2,15

\* Size 2" only HL1 for R22 (interior equipment) and HL1/HL2 for R23 (exterior equipment)

The fittings for Sealrite are outlined in chapter 5 Sealrite Fittings

SEALRITE	1/4"	5/16"	3/8"	1/2"	3/4"	1"	1 1/4"	1 1/2"	2"	2 1/2"	3"	4"
ISO	M10 - M12	M16 - M20	M16 - M20	M20	M25	M32	M40	M50 - M63	M50 - M63	M75	M90	-
Pg	7	09 - 11	11 - 13,5	16	21	29	36	42	48	-	-	-
NPT	-	-	1/2"	1/2"	3/4"	1"	1 1/4"	1 1/2"	2"	2 1/2"	3"	4"

# Anaconda Sealrite conduit

## TYPE ZHLS

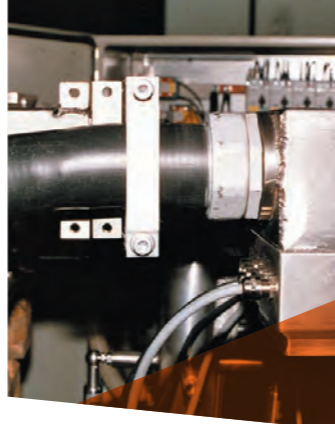

### ROBUST, HALOGEN FREE, LOW SMOKE, FLAME RETARDANT

Type ZHLS is a robust conduit with a galvanised steel core and a thick, smooth TPO cover which is both halogen free and flame retardant. The conduit meets European environment and health & safety regulations with regards to toxic gas emissions and smoke density requirements in case of fire. Type ZHLS meets the requirements of BS6853, LUL 1-085 and EN 45545-2 and is used in the metro-, train- and bus-building industry, in closed areas, airports, tunnels, (subway) stations and other infra-structure projects, but also in public buildings like malls, hospitals, and on elevators and escalators.

#### Material & Construction:

**Construction:** Hot dipped galvanised steel core, square locked with cord packing, thick smooth Thermoplastic Polyolefin (TPO compound) cover.

**Cover specifications:** Polyolefin, lead-free according to RoHS, sunlight and UV resistant, suitable for outside installation.

#### Special approvals, flame properties according to:

- EN 45545-2 (2013):  
R22 (interior equipment) class HL1, HL2 and HL3.  
R23 (exterior equipment) class HL1, HL2 and HL3.

(Average results : ClTnp = 0,09, Ds max = 121 and LOI = 41,5).

- BS 6853 (1999): Tabel 7 (Interior) Category 1b and II vehicle.  
Tabel 8 (Exterior) Category 1a, 1b and II vehicle.

#### Flame property tests:

- London Underground LUL 1-085 (2011)  
Tabel 4: limited and dispersed usage.

**Temperature:** -25 °C till +80 °C, intermittent up to +100 °C.

**Colour:** Black.



Square locked from 5/16" - 1 1/4"



Inter locked for size 1/4", 1 1/2" and 2"

SEALRITE	DIAMETRE		BENDING RADIUS (CL)		STANDARD CARTON		SMALL CARTON		REEL		WEIGHT (kg/m)
	Size (inch)	Inside (mm)	Outside (mm)	Static (mm)	Dynamic (mm)	Metre	Article No. black	Metre	Article No. black	Metre	
1/4"	6,4	11,5	40	50	30	309.006.1	-	-	-	-	0,15
5/16"	10,1	14,4	50	65	30	309.010.1	10	309.010.3	-	-	0,2
3/8"	12,6	17,8	60	85	30	309.012.1	10	309.012.3	250	309.012.5	0,3
1/2"	16	21,1	75	110	30	309.016.1	10	309.016.3	150	309.016.5	0,4
3/4"	21	26,4	90	140	30	309.020.1	10	309.020.3	120	309.020.5	0,55
1"	26,5	33,1	120	170	30	309.026.1	10	309.026.3	90	309.026.5	0,75
1 1/4"	35,1	41,8	135	215	15	309.035.1	-	-	60	309.035.5	1
1 1/2"	40,3	47,8	165	250	15	309.040.1	-	-	45	309.040.5	1,55
2"	51,6	59,9	210	300	15	309.050.1	-	-	22	309.050.5	2,15

The fittings for Sealrite are outlined in chapter 5 Sealrite Fittings

SEALRITE	1/4"	5/16"	3/8"	1/2"	3/4"	1"	1 1/4"	1 1/2"	2"	2 1/2"	3"	4"
ISO	M10 - M12	M16 - M20	M16 - M20	M20	M25	M32	M40	M50 - M63	M50 - M63	M75	M90	-
Pg	7	09 - 11	11 - 13,5	16	21	29	36	42	48	-	-	-
NPT	-	-	1/2"	1/2"	3/4"	1"	1 1/4"	1 1/2"	2"	2 1/2"	3"	4"

# Anaconda Sealrite conduit

## TYPE HTDL BLACK



### ROBUST, UL & CSA APPROVED, WIDE TEMPERATURE RANGE

Type HTDL is a robust conduit with a galvanised steel core and a thick, smooth PVC cover. An integral grounding copper wire (till 1.1/4") provides EMI / EMP shielding for cables that require electromagnetic protection. Type HTDL is UL & CSA approved and is used to protect cables on machines, equipment, enclosures and installations exported to countries outside, but also inside Europe. The conduit is used on transformers, paper-recycling machinery, internal transport systems, air-traffic-control systems, UMTS systems, oil & gas installations as well as the apparatus-building industry and equipment in hazardous areas.

#### Material & Construction:

**Construction:** Hot dipped galvanised steel core, square locked with integral copper grounding wire till 1.1/4", thick smooth thermoplastic cover (PVC compound).

**Cover specifications:** High and low temperature resistant PVC (lead-free acc. to RoHS), sunlight and UV resistant, suitable for outside installation. The cover is good resistant against oil and grease.

**Special approvals:** UL-360 (file # E18917) and CSA C 22.2 (file # 63790 / 158897).

Applicable for NEC Article 250.118 (6), 350, 300.22 (D), 620.21 and 645.5 (E) (2).

Suitable for use in hazardous environments according to NEC:

- Article 501.10 (B) (2) Class I, Division 2.
- Article 502.10 (A) (2) and (B) (2) Class II, Division 1 and 2
- Article 503.10 (A) (3) and (B) Class III, Division 1 and 2.

**Temperature:** -45 °C till +105 °C, intermittent up to +120 °C. Max. temperature according CSA is +75 °C.

**Colour:** Black.

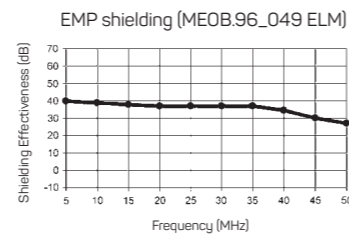

Square locked from 3/8" - 1.1/4"



Inter locked for size 1/2" - 4"

Anaconda  
Sealrite

SEALRITE	DIAMETRE		BENDING RADIUS (CL)		STANDARD CARTON		SMALL CARTON		REEL		WEIGHT (kg/m)	
	Size (inch)	Inside (mm)	Outside (mm)	Static (mm)	Dynamic (mm)	Metre	Article No. black	Metre	Article No. black	Metre		Article No. black
	3/8"	12,6	17,8	70	85	60	330.012.2	10	330.012.3	150	330.012.5	0,4
	1/2"	16,1	21,1	90	110	60	330.016.2	10	330.016.3	150	330.016.5	0,45
	3/4"	21,1	26,4	115	140	45	330.020.2	10	330.020.3	120	330.020.5	0,65
	1"	26,8	33,1	145	170	30	330.026.1	10	330.026.3	150	330.026.5	1,05
	1.1/4"	35,4	41,8	175	215	15	330.035.1	-	-	60	330.035.5	1,2
	1.1/2"	40,3	47,8	205	250	15	330.040.1	-	-	45	330.040.5	1,5
	2"	51,6	59,9	240	300	15	330.050.1	-	-	30	330.050.5	2,3
	2.1/2"	63,3	72,6	280	375	15	330.063.1	-	-	-	-	2,8
	3"	78,4	88,4	425	530	7,5	330.075.1	-	-	-	-	3,7

The fittings for Sealrite are outlined in chapter 5 Sealrite Fittings

SEALRITE	1/4"	5/16"	3/8"	1/2"	3/4"	1"	1.1/4"	1.1/2"	2"	2.1/2"	3"	4"
ISO	M10 - M12	M16 - M20	M16 - M20	M20	M25	M32	M40	M50 - M63	M50 - M63	M75	M90	-
Pg	7	09 - 11	11 - 13,5	16	21	29	36	42	48	-	-	-
NPT	-	-	1/2"	1/2"	3/4"	1"	1.1/4"	1.1/2"	2"	2.1/2"	3"	4"

# Anaconda Sealтите conduit

## TYPE HTUA GREY

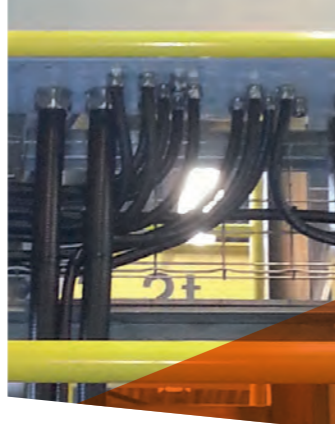

### ROBUST, UL & CSA APPROVED, WIDE TEMPERATURE RANGE

Type HTUA is a robust conduit with a galvanised steel core and a thick, smooth PVC cover. An integral grounding copper wire (till 1.1/4") provides a high level of EMI / EMP shielding for cables that require a high degree of electromagnetic protection. Type HTUA is UL & CSA approved and is used to protect cables on transformers, generators, motors, actuators, valves, machinery, equipment, enclosures and installations exported to countries outside, but also inside Europe.

#### Material & Construction:

**Construction:** Hot dipped galvanised steel core, square locked with integral copper grounding wire till 1.1/4", thick smooth thermoplastic cover (PVC compound).

**Cover specifications:** High and low temperature resistant PVC (lead-free acc. to RoHS), sunlight and UV resistant, suitable for outside installation. The cover is good resistant against oil and grease.

**Special approvals:** UL-360 (file # E18917) and CSA C 22.2 (file # 63790 / 158897).

Applicable for NEC Article 250.118 (6), 350, 300.22 (D), 620.21 and 645.5 (E) (2).

Suitable for use in hazardous environments according to NEC:

- Article 501.10 (B) (2) Class I, Division 2
- Article 502.10 (A) (2) and (B) (2) Class II, Division 1 and 2.
- Article 503.10 (A) (3) and (B) Class III, Division 1 and 2.

**Temperature:** -45 °C till +105 °C, intermittent up to +120 °C. Max. temperature according CSA is +75 °C.

**Colour:** Grey.

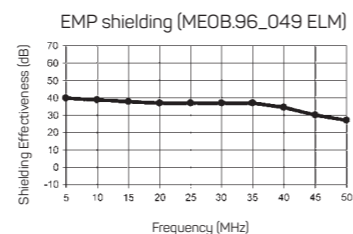

Square locked from 3/8" - 1.1/4"



Inter locked for size 1/2" - 4"

SEALTITE	DIAMETRE		BENDING RADIUS (CL)		STANDARD CARTON		SMALL CARTON		REEL		WEIGHT
	Size (inch)	Inside (mm)	Outside (mm)	Static (mm)	Dynamic (mm)	Metre	Article No. grey	Metre	Article No. grey	Metre	
3/8"	12,6	17,8	70	85	30	312.512.1	-	-	-	-	0,4
1/2"	16,1	21,1	90	110	30	312.516.1	-	-	-	-	0,45
3/4"	21,1	26,4	115	140	30	312.520.1	-	-	-	-	0,65
1"	26,8	33,1	145	170	30	312.526.1	-	-	-	-	1,05
1.1/4"	35,4	41,8	175	215	15	312.535.1	-	-	-	-	1,2
1.1/2"	40,3	47,8	205	250	15	312.540.1	-	-	-	-	1,5
2"	51,6	59,9	240	300	15	312.550.1	-	-	-	-	2,3
2.1/2"	63,3	72,6	280	375	15	312.563.1	-	-	-	-	2,8
3"	78,4	88,4	425	530	7,5	312.575.1	-	-	-	-	3,7

The fittings for Sealтите are outlined in chapter 5 Sealтите Fittings

SEALTITE	1/4"	5/16"	3/8"	1/2"	3/4"	1"	1.1/4"	1.1/2"	2"	2.1/2"	3"	4"
ISO	M10 - M12	M16 - M20	M16 - M20	M20	M25	M32	M40	M50 - M63	M50 - M63	M75	M90	-
Pg	7	09 - 11	11 - 13,5	16	21	29	36	42	48	-	-	-
NPT	-	-	1/2"	1/2"	3/4"	1"	1.1/4"	1.1/2"	2"	2.1/2"	3"	4"

# Anaconda Sealrite conduit

## TYPE ZHUA



Anaconda  
Sealrite

### ROBUST, UL / CSA APPROVED, HALOGEN FREE, FLAME RETARDANT (UL-94 V0)

Type ZHUA features a galvanised steel core with a thick, smooth TPU cover which is Halogen free and flame retardant in line with the smoke and fire requirements of EN 45545-2 and NFPA 130, ASTM E162, E662 and BSS 7239 standards. The conduit retains its flexibility at low and high temperatures and changing levels of humidity. Type ZHUA conduit is UL & CSA approved and has an integrated grounding copper wire (in sizes 3/8" to 1.1/4") to protect cables from electromagnetic interference. Type ZHUA is used in the metro-, train- and bus-building industry, in closed areas, airports, tunnels and (subway) stations, shipbuilding industry and navy.

#### Material & Construction:

**Construction:** Hot dipped galvanised steel core, square locked with integral copper grounding wire till 1.1/4", thick smooth Thermoplastic Polyurethane (VO-rated TPU compound) cover.  
**Cover specifications:** VO-rated Polyurethane, lead-free acc. to RoHS, sunlight and UV resistant, suitable for outside installation.

**Special approvals:** UL-360 (file # E18917). Applicable for NEC Article 250.118 (6), 350, 300.22 (D), 620.21 and 645.5 (E) (2). Suitable for use in hazardous environments according to NEC:

- Article 501.10 (B) (2) Class I, Division 2.
- Article 502.10 (A) (2) and (B) (2) Class II, Division 1 and 2.
- Article 503.10 (A) (3) and (B) Class III, Division 1

and 2.

- EN 45545-2: R22 (interior equipment) class HL1 and HL2, R23 (exterior equipment) class HL1/HL2/HL3. (Average results: ITCpnl = 0,12, Ds max = 230 and LOI >32).
- EN ISO 11925-2: passes the Allumability test at 30 sec.

**Flame property tests:** Official tests (VTEC Laboratories Inc.) indicate that the Poly-Urethane used in ZHUA meets the requirements for NFPA 130, ASTM E162, ASTM E662 and BSS 7239.

**Temperature:** -50 °C till +105 °C, intermittent up to +125 °C. Approved for UL from -40 °C till +80 °C.

**Colour:** Black.

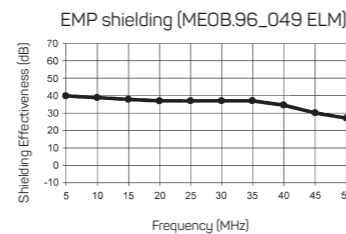

Square locked from 3/8" - 1.1/4"



Inter locked for size 1/2" - 2"

SEALRITE	DIAMETRE		BENDING RADIUS (CL)		STANDARD CARTON		SMALL CARTON		REEL		WEIGHT (kg/m)	
	Size (inch)	Inside (mm)	Outside (mm)	Static (mm)	Dynamic (mm)	Metre	Article No. black	Metre	Article No. black	Metre		Article No. black
	3/8"	12,6	17,8	70	85	30	334.012.1	-	-	150	334.012.5	0,4
	1/2"	16,1	21,1	90	110	30	334.016.1	-	-	150	334.016.5	0,45
	3/4"	21,1	26,4	115	140	30	334.020.1	-	-	150	334.020.5	0,65
	1"	26,8	33,1	145	170	30	334.026.1	-	-	120	334.026.5	1,05
	1.1/4"	35,4	41,8	175	215	15	334.035.1	-	-	60	334.035.5	1,2
	1.1/2"	40,3	47,8	205	250	15	334.040.1	-	-	45	334.040.5	1,5
	2"	51,6	59,9	240	300	15	334.050.1*	-	-	30	334.050.5	2,3

\* Size 2" only HL1 for R22 (interior equipment) and HL1/HL2 for R23 (exterior equipment)

The fittings for Sealrite are outlined in chapter 5 Sealrite Fittings

SEALRITE	1/4"	5/16"	3/8"	1/2"	3/4"	1"	1.1/4"	1.1/2"	2"	2.1/2"	3"	4"
ISO	M10 - M12	M16 - M20	M16 - M20	M20	M25	M32	M40	M50 - M63	M50 - M63	M75	M90	-
Pg	7	09 - 11	11 - 13,5	16	21	29	36	42	48	-	-	-
NPT	-	-	1/2"	1/2"	3/4"	1"	1.1/4"	1.1/2"	2"	2.1/2"	3"	4"



# Anaconda Sealbite conduit

## TYPE CW BLUE

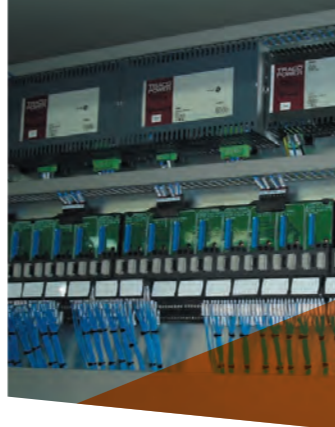

### ROBUST, UL & CSA APPROVED, COMPUTER WIRE CONDUIT

Type CW features a galvanised steel core and a thick, smooth PVC cover which is flame retardant and resistant to sunlight, heat, oils and chemicals. The conduit is UL & CSA certified and has an integrated grounding copper wire (in sizes 1/2" to 1.1/4") to protect cables from electromagnetic interference. Type CW can be used to protect cables on information technology equipment in data centres, air traffic-control centres as well as the apparatus-building industry and in underfloor and behind wall applications.

#### Material & Construction:

**Construction:** Hot dipped galvanised steel core, square locked with integral copper grounding wire till 1.1/4", thick smooth thermoplastic cover (PVC compound).

**Cover specifications:** PVC (lead-free acc. to RoHS), sunlight and UV resistant, suitable for outside installation. The cover is good resistant against oil and grease.

**Special approvals:** UL-360 (file # E18917) and CSA C 22.2 (file # 158897).

Applicable for NEC Article 250.118 (6), 350,

300.22 (D), 620.21 and 645.5 (E) (2).

Suitable for use in hazardous environments according to NEC:

- Article 501.10 (B) (2) Class I, Division 2.
- Article 502.10 (A) (2) and (B) (2) Class II, Division 1 and 2.
- Article 503.10 (A) (3) and (B) Class III, Division 1 and 2.

**Temperature:** -40 °C till +80 °C, intermittent up to +90 °C.

**Colour:** Blue.

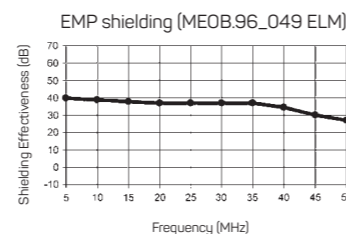

Square locked from 1/2" - 1.1/4"



Inter locked for size 1/2" - 4"

#### Classification according to NEN-EN-IEC 61386:

**Compression resistance:** Class 4, Heavy (1250 N).

**Impact resistance:** Class 4, Heavy (6 J).

**Tensile strength:** Class 4, Heavy (1000 N).

**Protection class:** IP 66 / 67 (dust-proof, water-tight).

SEALTITE	DIAMETRE		BENDING RADIUS (CL)		STANDARD CARTON		SMALL CARTON		REEL		WEIGHT
	Size (inch)	Inside (mm)	Outside (mm)	Static (mm)	Dynamic (mm)	Metre	Article No. blue	Metre	Article No. blue	Metre	
3/8"	-	-	-	-	-	-	-	-	-	-	-
1/2"	16,1	21,1	90	110	30	323.016.1	-	-	-	-	0,45
3/4"	21,1	26,4	115	140	30	323.020.1	-	-	-	-	0,65
1"	26,8	33,1	145	170	30	323.026.1	-	-	-	-	1,05
1.1/4"	35,4	41,8	175	215	15	323.035.1	-	-	-	-	1,2
1.1/2"	40,3	47,8	205	250	15	323.040.1	-	-	-	-	1,5
2"	51,6	59,9	240	300	15	323.050.1	-	-	-	-	2,3

The fittings for Sealbite are outlined in chapter 5 Sealbite Fittings















SEALTITE	1/4"	5/16"	3/8"	1/2"	3/4"	1"	1.1/4"	1.1/2"	2"	2.1/2"	3"	4"
ISO	M10 - M12	M16 - M20	M16 - M20	M20	M25	M32	M40	M50 - M63	M50 - M63	M75	M90	-
Pg	7	09 - 11	11 - 13,5	16	21	29	36	42	48	-	-	-
NPT	-	-	1/2"	1/2"	3/4"	1"	1.1/4"	1.1/2"	2"	2.1/2"	3"	4"



**Sealtite**  
**Special**

# Conduit selection table

## Anaconda Sealtite® Special

SEALTITE	MATERIAL	MATERIAL	TEMPERATURE		RESISTANCE (NEN-EN-IEC 61386)			FLEXI- BILITY	RESISTANCE		APPROVALS	PROTEC- TION	PAGE
			Min.	Max.	Compr.	Impact	Tensile		UV	Oil			
<b>HCI Black/ Blue</b>	Stainless steel AISI-304	PVC RoHS	-45 °C	+105 °C	4 1250N	4 (6J)	4 1000N	+++	++++	++++		IP 66	4 - 3
												IP 67	4 - 4
<b>HFI Black</b>	Stainless steel AISI-304	TPU Halogen free RoHS	-55 °C	+105 °C	4 1250N	4 (6J)	4 1000N	++++	++++	++++		IP 66	4 - 5
												IP 67	
<b>HFI Blue</b>	Stainless steel AISI-304	TPU Halogen free RoHS	-55 °C	+105 °C	4 1250N	4 (6J)	4 1000N	++++	++++	++++		IP 66	4 - 6
												IP 67	
<b>HCI Black</b>	Stainless steel AISI-304	TPE RoHS	-55 °C	+145 °C	4 1250N	4 (6J)	4 1000N	++++	+++	++		IP 66	4 - 7
												IP 67	
<b>HCI-316 Black</b>	Stainless steel AISI-316	PVC RoHS	-45 °C	+105 °C	4 1250N	4 (6J)	4 1000N	+++	++++	++++		IP 66	4 - 8
												IP 67	
<b>HFI-316 Black/ Blue</b>	Stainless steel AISI-316	TPU Halogen free RoHS	-55 °C	+105 °C	4 1250N	4 (6J)	4 1000N	++++	++++	++++		IP 66	4 - 09
												IP 67	
<b>EF-L Grey</b>	Aluminum	PVC RoHS	-20 °C	+80 °C	3 750N	3 (2J)	3 500N	+++	+++	+++		IP 66	4 - 11
												IP 67	
<b>AS Black</b>	Galvanised steel	PVC RoHS	-25 °C	+70 °C	4 1250N	4 (6J)	4 1000N	+++	++++	+++		IP 66	4 - 12
												IP 67	
<b>Shieldtite Grey</b>	Bronze	PVC RoHS	-45 °C	+105 °C	4 1250N	4 (6J)	4 1000N	+++	++++	++++		IP 66	4 - 13
												IP 67	
<b>Shieldtite Z1</b>	Bronze	TPU Halogen free RoHS	-50 °C	+105 °C	4 1250N	4 (6J)	4 1000N	+++	++++	++++		IP 66	4 - 14
												IP 67	
<b>FG White/ Blue</b>	Galvanised steel	PVC RoHS	-20 °C	+60 °C	4 1250N	4 (6J)	4 1000N	+++	++	+++		IP 66	4 - 15
												IP 67	
<b>HTFG White</b>	Galvanised steel	TPU Halogen free RoHS	-55 °C	+105 °C	4 1250N	4 (6J)	4 1000N	++++	++++	++++		IP 66	4 - 17
												IP 67	
<b>HTFG Blue</b>	Galvanised steel	TPU Halogen free RoHS	-55 °C	+105 °C	4 1250N	4 (6J)	4 1000N	++++	++++	++++		IP 66	4 - 18
												IP 67	
<b>HTFGI -316 Blue</b>	Stainless steel AISI-316	TPU Halogen free RoHS	-55 °C	+105 °C	4 1250N	4 (6J)	4 1000N	++++	++++	++++		IP 66	4 - 19
												IP 67	
<b>XTHF Grey</b>	Galvanised steel	Silicone Halogen free RoHS	-70 °C	+200 °C	4 1250N	4 (6J)	4 1000N	+++	+++	++++		IP 66	4 - 20
												IP 67	

# Anaconda Sealtite conduit

## TYPE HCI BLACK



### ROBUST, WIDE TEMPERATURE RANGE AND CORROSION RESISTANT

Type HCI has a AISI-304 stainless steel, corrosion resistant, core and a thick, smooth PVC cover that can handle very low and very high temperatures. This very robust conduit is designed for use in applications where mechanical, corrosion and thermal protection of cables are required. Type HCI is used on equipment and installations in coastal, offshore and other demanding locations where conditions can be extreme. Other areas of application include equipment, machines, control boxes and enclosures in the food, foundry, chemical and ceramics industries.

#### Material & Construction:

**Construction:** Stainless steel AISI-304, square locked with cord packing, thick smooth thermoplastic cover (PVC compound). For sizes 1/4", 1.1/2" and 2" a fully inter locked profile is used. Also available with innercore in AISI-316 (see type HCI-316).

**Cover specifications:** PVC, lead-free according to RoHS, sunlight and UV resistant, suitable for outside installation. The cover is good resistant against oil and grease.  
**Temperature:** -45 °C till +105 °C, intermittent up to +120 °C.  
**Colour:** Black (blue is also available).



Square locked from 5/16" - 1.1/4"



Inter locked for size 1/4", 1.1/2" - 2"

#### Classification according to NEN-EN-IEC 61386:

**Compression resistance:** Class 4, Heavy (1250 N).

**Impact resistance:** Class 4, Heavy (6 J).

**Tensile strength:** Class 4, Heavy (1000 N).

**Protection class:** IP 66 / 67 (dust-proof, water-tight).

Sealtite  
Special

SEALTITE	DIAMETRE		BENDING RADIUS (CL)		STANDARD CARTON		SMALL CARTON		REEL		WEIGHT
	Size (inch)	Inside (mm)	Outside (mm)	Static (mm)	Dynamic (mm)	Metre	Article No. black	Metre	Article No. black	Metre	
1/4"	6,4	11,5	40	50	50	318.006.1	-	-	-	-	0,15
5/16"	10,1	14,4	50	65	50	318.010.1	10	318.010.3	-	-	0,2
3/8"	12,6	17,8	60	85	75	318.012.1	10	318.012.3	-	-	0,3
1/2"	16	21,1	75	110	60	318.016.1	10	318.016.3	-	-	0,4
3/4"	21	26,4	90	140	50	318.020.1	10	318.020.3	-	-	0,55
1"	26,5	33,1	120	170	30	318.026.1	10	318.026.3	-	-	0,75
1.1/4"	35,1	41,8	135	215	30	318.035.1	10	318.035.3	-	-	1
1.1/2"	40,3	47,8	165	250	15	318.040.1	-	-	-	-	1,55
2"	51,6	59,9	210	300	15	318.050.1	-	-	-	-	2,15

The fittings for Sealtite are outlined in chapter 5 Sealtite Fittings

SEALTITE	1/4"	5/16"	3/8"	1/2"	3/4"	1"	1.1/4"	1.1/2"	2"	2.1/2"	3"	4"
ISO	M10 - M12	M16 - M20	M16 - M20	M20	M25	M32	M40	M50 - M63	M50 - M63	M75	M90	-
Pg	7	9 - 11	11 - 13,5	16	21	29	36	42	48	-	-	-
NPT	-	-	1/2"	1/2"	3/4"	1"	1.1/4"	1.1/2"	2"	2.1/2"	3"	4"

# Anaconda Sealtite conduit

## TYPE HCI BLUE



### ROBUST, WIDE TEMPERATURE RANGE AND CORROSION RESISTANT

Type HCI has a AISI-304 stainless steel, corrosion resistant, core and a thick, smooth PVC cover that can handle very low and very high temperatures. This very robust conduit is designed for use in applications where mechanical, corrosion and thermal protection of cables are required. Type HCI is used on equipment and installations in coastal, offshore and other demanding locations where conditions can be extreme. Other areas of application include equipment, machines, control boxes and enclosures in the food, foundry, chemical and ceramics industries.

#### Material & Construction:

**Construction:** Stainless steel AISI-304, square locked with cord packing, thick smooth thermoplastic cover (PVC compound).

**Cover specifications:** High and low temperature resistant PVC, lead-free according to RoHS, sunlight and UV resistant, suitable for outside installation. The cover is good resistant against oil and grease.

**Temperature:** -45 °C till +105 °C, intermittent up to +120 °C.

**Colour:** Blue (black is also available).

#### Classification according to NEN-EN-IEC 61386:

**Compression resistance:** Class 4, Heavy (1250 N).

**Impact resistance:** Class 4, Heavy (6 J).

**Tensile strength:** Class 4, Heavy (1000 N).

**Protection class:** IP 66 / 67 (dust-proof, water-tight).



Square locked from 3/8"- 1.1/4"

SEALTITE	DIAMETRE		BENDING RADIUS (CL)		STANDARD CARTON		SMALL CARTON		REEL		WEIGHT
	Size (inch)	Inside (mm)	Outside (mm)	Static (mm)	Dynamic (mm)	Metre	Article No. blue	Metre	Article No. blue	Metre	
3/8"	12,6	17,8	60	85	30	358.012.1	-	-	-	-	0,3
1/2"	16	21,1	75	110	30	358.016.1	-	-	-	-	0,4
3/4"	21	26,4	90	140	30	358.020.1	-	-	-	-	0,55
1"	26,5	33,1	120	170	30	358.026.1	-	-	-	-	0,75
1.1/4"	35,1	41,8	135	215	30	358.035.1	-	-	-	-	1

The fittings for Sealtite are outlined in chapter 5 Sealtite Fittings

SEALTITE	1/4"	5/16"	3/8"	1/2"	3/4"	1"	1.1/4"	1.1/2"	2"	2.1/2"	3"	4"
ISO	M10 - M12	M16 - M20	M16 - M20	M20	M25	M32	M40	M50 - M63	M50 - M63	M75	M90	-
Pg	7	9 - 11	11 - 13,5	16	21	29	36	42	48	-	-	-
NPT	-	-	1/2"	1/2"	3/4"	1"	1.1/4"	1.1/2"	2"	2.1/2"	3"	4"



# Anaconda Sealtite conduit

## TYPE HFI BLACK



### ROBUST, HALOGEN FREE, VERY FLEXIBLE, CHEMICAL RESISTANT, FLAME RETARDANT AND CORROSION RESISTANT

Type HFI is a robust conduit with a AISI-304 stainless steel core and a thick, smooth TPU cover that is chemical resistant, halogen free and flame retardant in compliance with European environment and health & safety guidelines. Type HFI retains its flexibility at both high and low temperatures and its stainless steel inner hose resists corrosion attack. These features make Type HFI suitable for installations in the chemical, food-processing, on-shore & off-shore, shipbuilding and marine industries.

#### Material & Construction:

**Construction:** Stainless steel (AISI-304) core, squarelocked with cord packing, thick smooth Thermoplastic Polyurethane (TPU compound) cover. For size 3/4" a fully inter locked profile is used.

**Cover specifications:** Polyurethane, lead-free according to RoHS, sunlight and UV resistant, suitable for outside installation. The cover is resistant against oil and grease.

**Temperature:** -55 °C till +105 °C, intermittent up to +125 °C.

**Colour:** Black (also available in blue).



Square locked from 3/8"- 1 1/4"



Inter locked for size 1/4"

#### Classification according to NEN-EN-IEC 61386:

**Compression resistance:** Class 4, Heavy (1250 N).

**Impact resistance:** Class 4, Heavy (6 J).

**Tensile strength:** Class 4, Heavy (1000 N).

**Protection class:** IP 66 / 67 (dust-proof, water-tight).

Sealtite  
Special

SEALTITE	DIAMETRE		BENDING RADIUS (CL)		STANDARD CARTON		SMALL CARTON		REEL		WEIGHT (kg/m)
	Size (inch)	Inside (mm)	Outside (mm)	Static (mm)	Dynamic (mm)	Metre	Article No. black	Metre	Article No. black	Metre	
1/4"	6,4	11,5	40	50	30	333.006.1	-	-	-	-	0,15
5/16"	10,1	14,4	50	62	30	333.010.1	10	333.010.3	-	-	0,20
3/8"	12,6	17,8	60	85	30	333.012.1	10	333.012.3	-	-	0,30
1/2"	16,0	21,1	75	110	30	333.016.1	10	333.016.3	-	-	0,40
3/4"	21,0	26,4	90	140	30	333.020.1	10	333.020.3	-	-	0,50
1"	26,5	33,1	120	170	30	333.026.1	10	333.026.3	-	-	0,70
1 1/4"	35,1	41,8	135	215	15	333.035.1	-	-	-	-	1,15

The fittings for Sealtite are outlined in chapter 5 Sealtite Fittings

SEALTITE	1/4"	5/16"	3/8"	1/2"	3/4"	1"	1 1/4"	1 1/2"	2"	2 1/2"	3"	4"
ISO	M10 - M12	M16 - M20	M16 - M20	M20	M25	M32	M40	M50 - M63	M50 - M63	M75	M90	-
Pg	7	9 - 11	11 - 13,5	16	21	29	36	42	48	-	-	-
NPT	-	-	1/2"	1/2"	3/4"	1"	1 1/4"	1 1/2"	2"	2 1/2"	3"	4"

# Anaconda Sealbite conduit



## TYPE HFI BLUE



### ROBUST, HALOGEN FREE, VERY FLEXIBLE, CHEMICAL RESISTANT, FLAME RETARDANT AND CORROSION RESISTANT

Type HFI is a robust conduit with a AISI-304 stainless steel core and a thick, smooth TPU cover that is chemical resistant, halogen free and flame retardant in compliance with European environment and health & safety guidelines. Type HFI retains its flexibility at both high and low temperatures and its stainless steel inner hose resists corrosion attack. These features make Type HFI suitable for installations in the chemical, food-processing, on-shore & off-shore, shipbuilding and marine industries.

#### Material & Construction:

**Construction:** Stainless steel (AISI-304) core, squarelocked with cord packing, thick smooth Thermoplastic Polyurethane (TPU compound) cover. From 1.1/2" and 2" a fully inter locked profile is used. Also available with inner core in AISI-316 (see HFI-316 blue).

**Cover specifications:** Polyurethane, lead-free according to RoHS, sunlight and UV resistant, suitable for outside installation. The cover is resistant against oil and grease.  
**Temperature:** -55 °C till +105 °C, intermittent up to +125 °C.  
**Colour:** Blue (also available in black).



#### Classification according to NEN-EN-IEC 61386:

**Compression resistance:** Class 4, Heavy (1250 N).  
**Impact resistance:** Class 4, Heavy (6 J).  
**Tensile strength:** Class 4, Heavy (1000 N).  
**Protection class:** IP 66 / 67 (dust-proof, water-tight).



Square locked from 3/8"- 1 1/4"



Inter locked for size 1 1/2" and 2"

SEALTITE	DIAMETRE		BENDING RADIUS (CL)		STANDARD CARTON		SMALL CARTON		REEL		WEIGHT (kg/m)	
	Size (inch)	Inside (mm)	Outside (mm)	Static (mm)	Dynamic (mm)	Metre	Article No. blue	Metre	Article No. blue	Metre		Article No. blue
	3/8"	12,6	17,8	60	85	30	339.212.1	-	-	-	-	0,3
	1/2"	16	21,1	75	110	30	339.216.1	-	-	-	-	0,4
	3/4"	21	26,4	90	140	30	339.220.1	-	-	-	-	0,5
	1"	26,5	33,1	120	170	30	339.226.1	-	-	-	-	0,7
	1 1/4"	35,1	41,8	135	215	15	339.235.1	-	-	-	-	1,15
	1 1/2"	40,3	47,8	165	250	15	339.240.1	-	-	-	-	1,5
	2"	51,6	59,9	210	300	15	339.250.1	-	-	-	-	2,15

The fittings for Sealbite are outlined in chapter 5 Sealbite Fittings

SEALTITE	1/4"	5/16"	3/8"	1/2"	3/4"	1"	1 1/4"	1 1/2"	2"	2 1/2"	3"	4"
ISO	M10 - M12	M16 - M20	M16 - M20	M20	M25	M32	M40	M50 - M63	M50 - M63	M75	M90	-
Pg	7	9 - 11	11 - 13,5	16	21	29	36	42	48	-	-	-
NPT	-	-	1/2"	1/2"	3/4"	1"	1 1/4"	1 1/2"	2"	2 1/2"	3"	4"

# Anaconda Sealrite conduit

## TYPE HCXI BLACK



### ROBUST, VERY WIDE TEMPERATURE RANGE AND CORROSION RESISTANT

Type HCXI is a very robust conduit with a AISI-304 stainless steel core and a thick, smooth TPE cover that has a very wide operating temperature range. The conduit retains its flexibility at both high and low temperatures and its stainless steel inner hose is corrosion resistant. Type HCXI is designed for use in applications where mechanical, corrosion and thermal protection of cables in on-shore and off-shore installations as well as equipment and machines installed in exposed areas in chemical, pharmaceutical, food processing, steel and foundry plants.

#### Material & Construction:

**Construction:** Stainless steel (AISI-304) core, square locked with cord packing, thick smooth Thermo-Plastic Elastomer (TPE compound) cover.

**Temperature:** -55 °C till +145 °C, intermittent up to +160 °C.

**Colour:** Black.

**Cover specifications:** TPE, lead-free according to RoHS, sunlight and UV resistant. Suitable for outside installation.

#### Classification according to NEN-EN-IEC 61386:

**Compression resistance:** Class 4, Heavy (1250 N).

**Impact resistance:** Class 4, Heavy (6 J).

**Tensile strength:** Class 4, Heavy (1000 N).

**Protection class:** IP 66 / 67 (dust-proof, water-tight).



Square locked from 3/8"- 1.1/4"

Sealrite  
Special

SEALRITE	DIAMETRE		BENDING RADIUS (CL)		STANDARD CARTON		SMALL CARTON		REEL		WEIGHT (kg/m)
	Size (inch)	Inside (mm)	Outside (mm)	Static (mm)	Dynamic (mm)	Metre	Article No. black	Metre	Article No. black	Metre	
3/8"	12,6	17,8	60	85	30	340.012.1	10	340.012.3	-	-	0,3
1/2"	16	21,1	75	110	30	340.016.1	10	340.016.3	-	-	0,4
3/4"	21	26,4	90	140	30	340.020.1	10	340.020.3	-	-	0,55
1"	26,5	33,1	120	170	30	340.026.1	10	340.026.3	-	-	0,75
1.1/4"	35,1	41,8	135	215	15	340.035.1	-	-	-	-	1

The fittings for Sealrite are outlined in chapter 5 Sealrite Fittings

SEALRITE	1/4"	5/16"	3/8"	1/2"	3/4"	1"	1.1/4"	1.1/2"	2"	2.1/2"	3"	4"
ISO	M10 - M12	M16 - M20	M16 - M20	M20	M25	M32	M40	M50 - M63	M50 - M63	M75	M90	-
Pg	7	9 - 11	11 - 13,5	16	21	29	36	42	48	-	-	-
NPT	-	-	1/2"	1/2"	3/4"	1"	1.1/4"	1.1/2"	2"	2.1/2"	3"	4"

# Anaconda Sealrite conduit

## TYPE HCI-316 BLACK



### ROBUST, WIDE TEMPERATURE RANGE AND SUPERIOR CORROSION RESISTANT

Type HCI-316 is a very robust conduit with a superior corrosion resistant AISI-316 stainless steel core and a thick, smooth PVC cover that is suitable for use in very low and very high temperature applications. This very robust conduit is designed for use in applications where mechanical, corrosion and thermal protection of cables installed on equipment and installations in coastal, offshore and other demanding locations where conditions can be extreme. Other areas of application include equipment, machines, control boxes and enclosures in the food, foundry, chemical and ceramics industries.

#### Material & Construction:

**Construction:** Stainless steel (AISI-316), square locked with cord packing, thick smooth thermoplastic cover (PVC compound).

**Cover specifications:** High and low temperature resistant PVC, lead-free according to RoHS, sunlight and UV resistant, suitable for outside installation. The cover is good resistant against oil and grease.

**Temperature:** -45 °C till +105 °C, intermittent up to +120 °C.

**Colour:** Black.

#### Classification according to NEN-EN-IEC 61386:

**Compression resistance:** Class 4, Heavy (1250 N).

**Impact resistance:** Class 4, Heavy (6 J).

**Tensile strength:** Class 4, Heavy (1000 N).

**Protection class:** IP 66 / 67 (dust-proof, water-tight).



Square locked from 3/8"- 1"

SEALRITE	DIAMETRE		BENDING RADIUS (CL)		STANDARD CARTON		SMALL CARTON		REEL		WEIGHT (kg/m)
	Size (inch)	Inside (mm)	Outside (mm)	Static (mm)	Dynamic (mm)	Metre	Article No. black	Metre	Article No. black	Metre	
3/8"	12,6	17,8	60	85	30	319.012.1	10	319.012.3	-	-	0,3
1/2"	16	21,1	75	110	30	319.016.1	10	319.016.3	-	-	0,4
3/4"	21	26,4	90	140	30	319.020.1	10	319.020.3	-	-	0,55
1"	26,5	33,1	120	170	30	319.026.1	10	319.026.3	-	-	0,75

The fittings for Sealrite are outlined in chapter 5 Sealrite Fittings

SEALRITE	1/4"	5/16"	3/8"	1/2"	3/4"	1"	1.1/4"	1.1/2"	2"	2.1/2"	3"	4"
ISO	M10 - M12	M16 - M20	M16 - M20	M20	M25	M32	M40	M50 - M63	M50 - M63	M75	M90	-
Pg	7	9 - 11	11 - 13,5	16	21	29	36	42	48	-	-	-
NPT	-	-	1/2"	1/2"	3/4"	1"	1.1/4"	1.1/2"	2"	2.1/2"	3"	4"

# Anaconda Sealtite conduit

## TYPE HFI-316 BLACK



### ROBUST, HALOGEN FREE, VERY FLEXIBLE, CHEMICAL RESISTANT, FLAME RETARDANT AND SUPERIOR CORROSION RESISTANT

Type HFI-316 Black is a robust conduit with a AISI-316 stainless steel core and a thick, smooth TPU cover that is highly chemical resistant, halogen free and flame retardant in compliance with European environmental health & safety guidelines. The conduit retains its flexibility at both high and low temperatures and is superior corrosion resistant. Type HFI-316 Black suitable for the mechanical protection of sensitive cables and wires in hazardous applications in the oil & gas, chemical and petro-chemical and shipbuilding industries.

#### Material & Construction:

**Construction:** Stainless steel (AISI-316) core, squarelocked with cord packing, thick smooth Thermoplastic Polyurethane (TPU compound) cover.

**Cover specifications:** Polyurethane, lead-free according to RoHS, sunlight and UV resistant, suitable for outside installation. The cover is resistant against oil and grease.

**Temperature:** -55 °C till +105 °C, intermittent up to +125 °C.

**Colour:** Black, availability subject to minimum order quantities (also available in blue).

#### Classification according to NEN-EN-IEC 61386:

**Compression resistance:** Class 4, Heavy (1250 N).

**Impact resistance:** Class 4, Heavy (6 J).

**Tensile strength:** Class 4, Heavy (1000 N).

**Protection class:** IP 66 / 67 (dust-proof, water-tight).



Square locked from 3/8"- 1"

Sealtite  
Special

SEALTITE	DIAMETRE		BENDING RADIUS (CL)		STANDARD CARTON		SMALL CARTON		REEL		WEIGHT
	Size (inch)	Inside (mm)	Outside (mm)	Static (mm)	Dynamic (mm)	Metre	Article No. black	Metre	Article No. black	Metre	
3/8"	12,6	17,8	60	85	30	333.512.1	-	-	-	-	0,3
1/2"	16	21,1	75	110	30	333.516.1	-	-	-	-	0,4
3/4"	21	26,4	90	140	30	333.520.1	-	-	-	-	0,5
1"	26,5	33,1	120	170	30	333.526.1	-	-	-	-	0,7

The fittings for Sealtite are outlined in chapter 5 Sealtite Fittings

SEALTITE	1/4"	5/16"	3/8"	1/2"	3/4"	1"	1.1/4"	1.1/2"	2"	2.1/2"	3"	4"
ISO	M10 - M12	M16 - M20	M16 - M20	M20	M25	M32	M40	M50 - M63	M50 - M63	M75	M90	-
Pg	7	9 - 11	11 - 13,5	16	21	29	36	42	48	-	-	-
NPT	-	-	1/2"	1/2"	3/4"	1"	1.1/4"	1.1/2"	2"	2.1/2"	3"	4"



# Anaconda Sealrite conduit

## TYPE HFI-316 BLUE



### ROBUST, HALOGEN FREE, VERY FLEXIBLE, CHEMICAL RESISTANT, FLAME RETARDANT AND SUPERIOR CORROSION RESISTANT

Type HFI-316 Blue is a robust conduit with a AISI-316 stainless steel core and a thick, smooth TPU cover that is highly chemical resistant, halogen free and flame retardant in compliance with European environmental health & safety guidelines. The conduit retains its flexibility at both high and low temperatures and is superior corrosion resistant. Type HFI-316 Blue is suitable for the mechanical protection of sensitive cables and wires in hazardous, including low energy ATEX Ex i applications in the oil & gas, chemical and petro-chemical, food processing, pharmaceutical and shipbuilding industries.

#### Material & Construction:

**Construction:** Stainless steel (AISI-316) core, squarelocked with cord packing, thick smooth Thermoplastic Polyurethane (TPU compound) cover.

**Temperature:** -55 °C till +105 °C, intermittent up to +125 °C.

**Colour:** Blue (subject to minimum order quantities also available in black).

**Cover specifications:** Polyurethane, lead-free according to RoHS, sunlight and UV resistant, suitable for outside installation. The cover is resistant against oil and grease.

#### Classification according to NEN-EN-IEC 61386:

**Compression resistance:** Class 4, Heavy (1250 N).

**Impact resistance:** Class 4, Heavy (6 J).

**Tensile strength:** Class 4, Heavy (1000 N).

**Protection class:** IP 66 / 67 (dust-proof, water-tight).



Square locked from 3/8"- 1"

SEALTITE	DIAMETRE		BENDING RADIUS (CL)		STANDARD CARTON		SMALL CARTON		REEL		WEIGHT
	Size (inch)	Inside (mm)	Outside (mm)	Static (mm)	Dynamic (mm)	Metre	Article No. blue	Metre	Article No. blue	Metre	
3/8"	12,6	17,8	60	85	30	339.412.1	-	-	-	-	0,3
1/2"	16	21,1	75	110	30	339.416.1	-	-	-	-	0,4
3/4"	21	26,4	90	140	30	339.420.1	-	-	-	-	0,5
1"	26,5	33,1	120	170	30	339.426.1	-	-	-	-	0,7

The fittings for Sealrite are outlined in chapter 5 Sealrite Fittings

SEALTITE	1/4"	5/16"	3/8"	1/2"	3/4"	1"	1.1/4"	1.1/2"	2"	2.1/2"	3"	4"
ISO	M10 - M12	M16 - M20	M16 - M20	M20	M25	M32	M40	M50 - M63	M50 - M63	M75	M90	-
Pg	7	9 - 11	11 - 13,5	16	21	29	36	42	48	-	-	-
NPT	-	-	1/2"	1/2"	3/4"	1"	1.1/4"	1.1/2"	2"	2.1/2"	3"	4"

# Anaconda Sealтите conduit

## TYPE EF-L GREY



### LIGHTWEIGHT AND EXTRA CORROSION RESISTANT

Type EF-L is a lightweight conduit with an aluminum core and a PVC cover. The conduit is very flexible and is used to protect cables and wires on machines, equipment and cabinets used in the train-building industry but also in military/naval applications where weight is important and non-magnetic, non-corrosive materials are needed.

#### Material & Construction:

**Construction:** Aluminum core, square locked with cord packing, thick smooth thermoplastic cover (PVC compound). **Temperature:** -20 °C till +80 °C, intermittent up to +90 °C. **Colour:** Grey.

**Cover specifications:** PVC, lead-free according to RoHS, sunlight and UV resistant, suitable for outside installation.



Square locked from 3/8" - 2"



Inter locked for size 1.1/2" and 2"

#### Classification according to NEN-EN-IEC 61386:

**Compression resistance:** Class 3, Medium (750 N).

**Impact resistance:** Class 3, Medium (2 J).

**Tensile strength:** Class 3, Medium (500 N).

**Protection class:** IP 66 / 67 (dust-proof, water-tight).

Sealтите Special

SEALTITE	DIAMETRE		BENDING RADIUS (CL)		STANDARD CARTON		SMALL CARTON		REEL		WEIGHT (kg/m)
	Size (inch)	Inside (mm)	Outside (mm)	Static (mm)	Dynamic (mm)	Metre	Article No. grey	Metre	Article No. grey	Metre	
3/8"	12,6	17,8	60	85	30	324.012.1	-	-	-	-	0,2
1/2"	16	21,1	75	110	30	324.016.1	-	-	-	-	0,25
3/4"	21	26,4	90	140	30	324.020.1	-	-	-	-	0,3
1"	26,5	33,1	120	170	30	324.026.1	-	-	-	-	0,5
1.1/4"	35,1	41,8	135	215	15	324.035.1	-	-	-	-	0,65
1.1/2"	40,3	47,8	165	250	15	324.040.1	-	-	-	-	0,9
2"	51,6	59,9	210	300	15	324.050.1	-	-	-	-	1,2

The fittings for Sealтите are outlined in chapter 5 on page 5 - 38

SEALTITE	1/4"	5/16"	3/8"	1/2"	3/4"	1"	1.1/4"	1.1/2"	2"	2.1/2"	3"	4"
ISO	M10 - M12	M16 - M20	M16 - M20	M20	M25	M32	M40	M50 - M63	M50 - M63	M75	M90	-
Pg	7	9 - 11	11 - 13,5	16	21	29	36	42	48	-	-	-
NPT	-	-	1/2"	1/2"	3/4"	1"	1.1/4"	1.1/2"	2"	2.1/2"	3"	4"

# Anaconda Sealrite conduit

## TYPE AS BLACK



### ROBUST & ANTI-STATIC

Type AS is a robust conduit with a galvanised steel core and a thick, smooth anti-static PVC cover for use in hazardous areas where a risk of explosion exists. The conduit cover provides a surface resistance of  $<10^9$  Ohm according to Standard NEN-EN-IEC 600079-0, Section 26-13 thus preventing electrostatic charge from accumulating on the surface of the conduit cover and also sparks in the case of discharge by contact.

#### Material & Construction:

**Construction:** Hot dipped galvanised steel core, square locked with cord packing, thick smooth thermoplastic cover (PVC compound).

From 1.1/2" and 2" a fully inter locked profile will be used.

**Cover specifications:** Anti-Static PVC, lead-free according to RoHS, sunlight and UV resistant, suitable for outdoor use and burial installation.

**Anti-Static performance:** Surface resistance  $< 10^9$  Ohm, meeting the requirements of standard NEN-EN-IEC 60079-0, section 26-13.

**Temperature:** -25 °C till +70 °C, intermittent up to +90 °C.

**Colour:** Black.



Square locked from 5/16"- 1.1/4"



Inter locked for size 1.1/2" and 2"

#### Classification according to NEN-EN-IEC 61386:

**Compression resistance:** Class 4, Heavy (1250 N).

**Impact resistance:** Class 4, Heavy (6 J).

**Tensile strength:** Class 4, Heavy (1000 N).

**Protection class:** IP 66 / 67 (dust-proof, water-tight).

SEALRITE	DIAMETRE		BENDING RADIUS (CL)		STANDARD CARTON		SMALL CARTON		REEL		WEIGHT
	Size (inch)	Inside (mm)	Outside (mm)	Static (mm)	Dynamic (mm)	Metre	Article No. black	Metre	Article No. black	Metre	
5/16"	10,1	14,4	50	65	30	350.010.1	-	-	-	-	0,2
3/8"	12,6	17,8	60	85	30	350.012.1	-	-	-	-	0,3
1/2"	16	21,1	75	110	30	350.016.1	-	-	-	-	0,4
3/4"	21	26,4	90	140	30	350.020.1	-	-	-	-	0,55
1"	26,5	33,1	120	170	30	350.026.1	-	-	-	-	0,75
1.1/4"	35,1	41,8	150	215	15	350.035.1	-	-	-	-	1
1.1/2"	40,3	47,8	200	250	15	350.040.1	-	-	-	-	1,55
2"	51,6	59,9	250	300	15	350.050.1	-	-	-	-	2,15

The fittings for Sealrite are outlined in chapter 5 Sealrite Fittings

SEALRITE	1/4"	5/16"	3/8"	1/2"	3/4"	1"	1.1/4"	1.1/2"	2"	2.1/2"	3"	4"
ISO	M10 - M12	M16 - M20	M16 - M20	M20	M25	M32	M40	M50 - M63	M50 - M63	M75	M90	-
Pg	7	9 - 11	11 - 13,5	16	21	29	36	42	48	-	-	-
NPT	-	-	1/2"	1/2"	3/4"	1"	1.1/4"	1.1/2"	2"	2.1/2"	3"	4"

# Anaconda Sealtite conduit

## TYPE SHIELDTITE GREY



### ROBUST, EMI / EMP SHIELDING

Type Shieldtite is a very robust conduit with a fully interlocked bronze core and thick, smooth PVC cover designed specifically for protection of cables against electromagnetic interference and pulses (EMI / EMP). The conduit has been developed according to MIL-STD 1310D (military standard USA) and is used in applications requiring a high degree of shielding and electrical continuity on equipment and installations in the military, marine and air traffic control sectors. The conduit is resistant to UV, sunlight, heat, oils and chemicals.

#### Material & Construction:

**Construction:** Bronze core, fully-interlocked, thick smooth thermoplastic cover (PVC compound).

**Cover specifications:** PVC, lead-free according to RoHS, sunlight and UV resistant, suitable for outside installation. The cover is good resistant against oil and grease. On demand also available with halogen free cover (see type Shieldtite Z1).

**Special approvals:** MIL-STD 1310D.

**Temperature:** -45 °C till +105 °C, intermittent up to +120 °C.

**Colour:** Grey.

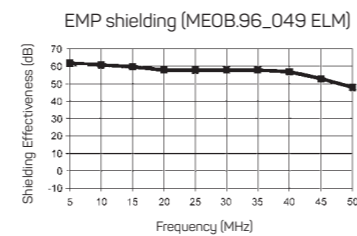

Inter locked

#### Classification according to NEN-EN-IEC 61386:

**Compression resistance:** Class 4, Heavy (1250 N).

**Impact resistance:** Class 4, Heavy (6 J).

**Tensile strength:** Class 4, Heavy (1000 N).

**Protection class:** IP 66 / 67 (dust-proof, water-tight).

SEALTITE	DIAMETRE		BENDING RADIUS (CL)		STANDARD CARTON		SMALL CARTON		REEL		WEIGHT
	Size (inch)	Inside (mm)	Outside (mm)	Static (mm)	Dynamic (mm)	Metre	Article No. grey	Metre	Article No. grey	Metre	
3/8"	12,6	17,8	80	100	30	304.012.1	-	-	250	304.012.5	0,3
1/2"	16	21,1	90	125	30	304.016.1	-	-	150	304.016.5	0,4
3/4"	21	26,4	110	160	30	304.020.1	-	-	120	304.020.5	0,6
1"	26,5	33,1	120	200	30	304.026.1	-	-	90	304.026.5	0,8
1.1/4"	35,1	41,8	135	240	15	304.035.1	-	-	60	304.035.5	1,1
1.1/2"	40,3	47,8	200	290	15	304.040.1	-	-	45	304.040.5	1,5
2"	51,6	59,9	275	380	15	304.050.1	-	-	30	304.050.5	2,1

The fittings for Sealtite are outlined in chapter 5 Sealtite Fittings

SEALTITE	1/4"	5/16"	3/8"	1/2"	3/4"	1"	1.1/4"	1.1/2"	2"	2.1/2"	3"	4"
ISO	M10 - M12	M16 - M20	M16 - M20	M20	M25	M32	M40	M50 - M63	M50 - M63	M75	M90	-
Pg	7	9 - 11	11 - 13,5	16	21	29	36	42	48	-	-	-
NPT	-	-	1/2"	1/2"	3/4"	1"	1.1/4"	1.1/2"	2"	2.1/2"	3"	4"

Sealtite Special

# Anaconda Sealtite conduit

## TYPE SHIELDTITE Z1 GREY



### ROBUST, EMI / EMP SHIELDING AND HALOGEN FREE

Type Shieldtite Z1 is a very robust conduit with a fully interlocked bronze core and thick, smooth low smoke, halogen free TPU cover. The conduit meets the requirements of MIL-STD-1310D in applications requiring protection against electromagnetic interference. Type Shieldtite Z1 TPU cover complies with the smoke and fire requirements of EN 45545-2 and is resistant to sunlight, heat, oil and chemicals. The conduit provides EMI/EMC shielding applications on rolling stock, submarines, control stations and towers and other applications where electrical continuity is required.

#### Material & Construction:

**Construction:** Bronze core, fully-interlocked, thick smooth Thermoplastic Polyurethane (TPU compound) cover.

**Cover specifications:** VO-rated Polyurethane, lead-free according to RoHS, sunlight and UV resistant, suitable for outside installation. The cover is resistant against oil and grease.

**Special approvals, flame properties according to:**

- EN 45545-2 (2013):  
R22 (interior equipment) class HL1 and HL2  
R23 (exterior equipment) class HL1 and HL2

(Average results: CIT<sub>nlp</sub> = 0,19, D<sub>s</sub> max = 262 and LOI = 31,6).

- EN ISO 11925-2: passes the Allumability test at 30 sec.

**Flame property tests:** Official tests (VTEC Laboratories Inc.) indicate that the Polyurethane used in Shieldtite Z1 meets the requirements for NFPA 130, ASTM E162, ASTM E662 and BSS 7239.

**Temperature:** -50 °C till +105 °C, intermittent up to +125 °C.

**Colour:** Grey.

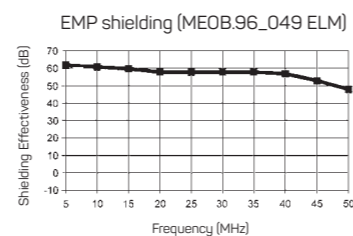

Inter locked

#### Classification according to NEN-EN-IEC 61386:

**Compression resistance:** Class 4, Heavy (1250 N).

**Impact resistance:** Class 4, Heavy (6 J).

**Tensile strength:** Class 4, Heavy (1000 N).

**Protection class:** IP 66 / 67 (dust-proof, water-tight).

SEALTITE	DIAMETRE		BENDING RADIUS (CL)		STANDARD CARTON		SMALL CARTON		REEL		WEIGHT
	Size (inch)	Inside (mm)	Outside (mm)	Static (mm)	Dynamic (mm)	Metre	Article No. grey	Metre	Article No. grey	Metre	
3/8"	12,6	17,8	80	100	30	304.212.1	-	-	-	-	0,3
1/2"	16	21,1	90	125	30	304.216.1	-	-	-	-	0,4
3/4"	21	26,4	110	160	30	304.220.1	-	-	-	-	0,5
1"	26,5	33,1	120	200	30	304.226.1	-	-	-	-	0,7
1.1/4"	35,1	41,8	135	240	15	304.235.1	-	-	-	-	1,1
1.1/2"	40,3	47,8	200	290	15	304.240.1	-	-	-	-	1,5
2"	51,6	59,9	275	380	15	304.250.1	-	-	-	-	2

The fittings for Sealtite are outlined in chapter 5 Sealtite Fittings

SEALTITE	1/4"	5/16"	3/8"	1/2"	3/4"	1"	1.1/4"	1.1/2"	2"	2.1/2"	3"	4"
ISO	M10 - M12	M16 - M20	M16 - M20	M20	M25	M32	M40	M50 - M63	M50 - M63	M75	M90	-
Pg	7	9 - 11	11 - 13,5	16	21	29	36	42	48	-	-	-
NPT	-	-	1/2"	1/2"	3/4"	1"	1.1/4"	1.1/2"	2"	2.1/2"	3"	4"



# Anaconda Sealtite conduit

## TYPE FG WHITE



### ROBUST, 'HYGIENICALLY DESIGNED' FOOD GRADE

Type FG is a robust, very flexible conduit with a galvanised steel core and a thick, smooth PVC cover for use on machines and equipment in the food and beverage industry. The hygienically designed conduit cover utilises a microbe inhibiting compound formulated for food and beverage applications per FDA CFR21 requirements and is suitable for use in zones where wash and wipe down frequently take place, including the splash zone.

#### Material & Construction:

**Construction:** Hot dipped galvanised steel core, square locked with cord packing, thick smooth thermoplastic cover (PVC compound).

**Temperature:** -20 °C till +60 °C, intermittent up to +80 °C.

**Colour:** White.

**Cover specifications:** PVC, lead-free according to RoHS, specially formulated for food and beverage applications per FDA CFR 21 requirements.

#### Classification according to NEN-EN-IEC 61386:

**Compression resistance:** Class 4, Heavy (1250 N).

**Impact resistance:** Class 4, Heavy (6 J).

**Tensile strength:** Class 4, Heavy (1000 N).

**Protection class:** IP 66 / 67 (dust-proof, water-tight).



Square locked from 3/8"- 1"

Sealtite  
Special

SEALTITE	DIAMETRE		BENDING RADIUS (CL)		STANDARD CARTON		SMALL CARTON		REEL		WEIGHT (kg/m)
	Size (inch)	Inside (mm)	Outside (mm)	Static (mm)	Dynamic (mm)	Metre	Article No. white	Metre	Article No. white	Metre	
3/8"	12,6	17,8	60	85	30	341.012.1	-	-	-	-	0,3
1/2"	16	21,1	75	110	30	341.016.1	-	-	-	-	0,4
3/4"	21	26,4	90	140	30	341.020.1	-	-	-	-	0,55
1"	26,5	33,1	120	170	30	341.026.1	-	-	-	-	0,75

The fittings for Sealtite are outlined in chapter 5 Sealtite Fittings

SEALTITE	1/4"	5/16"	3/8"	1/2"	3/4"	1"	1.1/4"	1.1/2"	2"	2.1/2"	3"	4"
ISO	M10 - M12	M16 - M20	M16 - M20	M20	M25	M32	M40	M50 - M63	M50 - M63	M75	M90	-
Pg	7	9 - 11	11 - 13,5	16	21	29	36	42	48	-	-	-
NPT	-	-	1/2"	1/2"	3/4"	1"	1.1/4"	1.1/2"	2"	2.1/2"	3"	4"

# Anaconda Sealtite conduit

## TYPE FG BLUE



### ROBUST, 'HYGIENICALLY DESIGNED' FOOD GRADE

Type FG is a robust, very flexible conduit with a galvanised steel core and a thick, smooth PVC cover for use on machines and equipment in the food and beverage industry. The hygienically designed conduit cover utilises a microbe inhibiting compound formulated for food and beverage applications per FDA CFR21 requirements and is suitable for use in zones where wash and wipe down frequently take place, including the splash zone.

#### Material & Construction:

**Construction:** Hot dipped galvanised steel core, square locked with cord packing, thick smooth thermoplastic cover (PVC compound).  
From 1.1/2" and 2" a fully inter locked profile will be used.

**Cover specifications:** PVC, lead-free according to RoHS, specially formulated for food and beverage applications per FDA CFR 21 requirements.  
**Temperature:** -20 °C till +60 °C, intermittent up to +80 °C.  
**Colour:** Blue.



#### Classification according to NEN-EN-IEC 61386:

**Compression resistance:** Class 4, Heavy (1250 N).  
**Impact resistance:** Class 4, Heavy (6 J).  
**Tensile strength:** Class 4, Heavy (1000 N).  
**Protection class:** IP 66 / 67 (dust-proof, water-tight).

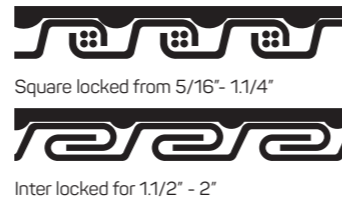

SEALTITE	DIAMETRE		BENDING RADIUS (CL)		STANDARD CARTON		SMALL CARTON		REEL		WEIGHT (kg/m)
	Size (inch)	Inside (mm)	Outside (mm)	Static (mm)	Dynamic (mm)	Metre	Article No. blue	Metre	Article No. blue	Metre	
5/16"	10,1	14,4	50	65	30	352.010.1	-	-	-	-	0,2
3/8"	12,6	17,8	60	85	30	352.012.1	-	-	-	-	0,3
1/2"	16	21,1	75	110	30	352.016.1	-	-	-	-	0,4
3/4"	21	26,4	90	140	30	352.020.1	-	-	-	-	0,55
1"	26,5	33,1	120	170	30	352.026.1	-	-	-	-	0,75
1.1/4"	35,1	41,8	135	215	15	352.035.1	-	-	-	-	1
1.1/2"	40,3	47,8	200	250	15	352.040.1	-	-	-	-	1,55
2"	51,6	59,9	250	300	15	352.050.1	-	-	-	-	2,15

The fittings for Sealtite are outlined in chapter 5 Sealtite Fittings

SEALTITE	1/4"	5/16"	3/8"	1/2"	3/4"	1"	1.1/4"	1.1/2"	2"	2.1/2"	3"	4"
ISO	M10 - M12	M16 - M20	M16 - M20	M20	M25	M32	M40	M50 - M63	M50 - M63	M75	M90	-
Pg	7	9 - 11	11 - 13,5	16	21	29	36	42	48	-	-	-
NPT	-	-	1/2"	1/2"	3/4"	1"	1.1/4"	1.1/2"	2"	2.1/2"	3"	4"

# Anaconda Sealtite conduit

## TYPE HTFG WHITE



### ROBUST, 'HYGIENICALLY DESIGNED' FOOD GRADE, HIGH TEMPERATURES

Type HTFG is a robust, highly flexible conduit with a galvanised steel core and a thick, smooth TPU cover for use on machines and equipment in the food and beverage industry. The hygienically designed conduit cover utilises a microbe inhibiting compound formulated for food and beverage applications per FDA CFR21 requirements and is suitable for use in zones where wash and wipe down frequently take place, including the splash zone.

#### Material & Construction:

**Construction:** Hot dipped galvanised steel core, square locked with cord packing, thick smooth Thermoplastic Polyurethane cover (TPU compound). From 1.1/2" and 2" a fully inter locked profile will be used.

**Cover specifications:** TPU, halogenfree, lead-free according to RoHS, specially formulated for food and beverage applications per FDA CFR 21 requirements.

**Temperature:** -55 °C till +105 °C, intermittent up to +125 °C.

**Colour:** White.



Square locked from 3/8" - 1.1/4"



Inter locked for size 1.1/2" and 2"

#### Classification according to NEN-EN-IEC 61386:

**Compression resistance:** Class 4, Heavy (1250 N).

**Impact resistance:** Class 4, Heavy (6 J).

**Tensile strength:** Class 4, Heavy (1000 N).

**Protection class:** IP 66 / 67 (dust-proof, water-tight).

Sealtite  
Special

SEALTITE	DIAMETRE		BENDING RADIUS (CL)		STANDARD CARTON		SMALL CARTON		REEL		WEIGHT (kg/m)
	Size (inch)	Inside (mm)	Outside (mm)	Static (mm)	Dynamic (mm)	Metre	Article No. white	Metre	Article No. white	Metre	
3/8"	12,6	17,8	60	85	30	308.212.1	-	-	-	-	0,3
1/2"	16	21,1	75	110	30	308.216.1	-	-	-	-	0,4
3/4"	21	26,4	90	140	30	308.220.1	-	-	-	-	0,5
1"	26,5	33,1	120	170	30	308.226.1	-	-	-	-	0,7
1.1/4"	35,1	41,8	135	215	15	308.235.1	-	-	-	-	1,15
1.1/2"	40,3	47,8	165	250	15	308.240.1	-	-	-	-	1,5
2"	51,6	59,9	210	300	15	308.250.1	-	-	-	-	2,15

The fittings for Sealtite are outlined in chapter 5 Sealtite Fittings

SEALTITE	1/4"	5/16"	3/8"	1/2"	3/4"	1"	1.1/4"	1.1/2"	2"	2.1/2"	3"	4"
ISO	M10 - M12	M16 - M20	M16 - M20	M20	M25	M32	M40	M50 - M63	M50 - M63	M75	M90	-
Pg	7	9 - 11	11 - 13,5	16	21	29	36	42	48	-	-	-
NPT	-	-	1/2"	1/2"	3/4"	1"	1.1/4"	1.1/2"	2"	2.1/2"	3"	4"

# Anaconda Sealtite conduit

## TYPE HTFG BLUE



### ROBUST, 'HYGIENICALLY DESIGNED' FOOD GRADE, HIGH TEMPERATURES

Type HTFG is a robust, highly flexible conduit with a galvanised steel core and a thick, smooth TPU cover for use on machines and equipment in the food and beverage industry. The hygienically designed conduit cover utilises a microbe inhibiting compound formulated for food and beverage applications per FDA CFR21 requirements and is suitable for use in zones where wash and wipe down frequently take place, including the splash zone.

#### Material & Construction:

**Construction:** Hot dipped galvanised steel core, square locked with cord packing, thick smooth Thermoplastic Polyurethane cover (TPU compound). From 1.1/2" and 2" a fully inter locked profile will be used.

**Cover specifications:** TPU, halogenfree, lead-free according to RoHS, specially formulated for food and beverage applications per FDA CFR 21 requirements.

**Temperature:** -55 °C till +105 °C, intermittent up to +125 °C.

**Colour:** Blue.



#### Classification according to NEN-EN-IEC 61386:

**Compression resistance:** Class 4, Heavy (1250 N).

**Impact resistance:** Class 4, Heavy (6 J).

**Tensile strength:** Class 4, Heavy (1000 N).

**Protection class:** IP 66 / 67 (dust-proof, water-tight).



Square locked from 3/8" - 1.1/4"



Inter locked for size 1.1/2" and 2"

SEALTITE	DIAMETRE		BENDING RADIUS (CL)		STANDARD CARTON		SMALL CARTON		REEL		WEIGHT (kg/m)	
	Size (inch)	Inside (mm)	Outside (mm)	Static (mm)	Dynamic (mm)	Metre	Article No. blue	Metre	Article No. blue	Metre		Article No. blue
	3/8"	12,6	17,8	60	85	30	308.012.1	-	-	-	-	0,3
	1/2"	16	21,1	75	110	30	308.016.1	-	-	-	-	0,4
	3/4"	21	26,4	90	140	30	308.020.1	-	-	-	-	0,5
	1"	26,5	33,1	120	170	30	308.026.1	-	-	-	-	0,7
	1.1/4"	35,1	41,8	135	215	15	308.035.1	-	-	-	-	1,15
	1.1/2"	40,3	47,8	165	250	15	308.040.1	-	-	-	-	1,5
	2"	51,6	59,9	210	300	15	308.050.1	-	-	-	-	2,15

The fittings for Sealtite are outlined in chapter 5 Sealtite Fittings

SEALTITE	1/4"	5/16"	3/8"	1/2"	3/4"	1"	1.1/4"	1.1/2"	2"	2.1/2"	3"	4"
ISO	M10 - M12	M16 - M20	M16 - M20	M20	M25	M32	M40	M50 - M63	M50 - M63	M75	M90	-
Pg	7	9 - 11	11 - 13,5	16	21	29	36	42	48	-	-	-
NPT	-	-	1/2"	1/2"	3/4"	1"	1.1/4"	1.1/2"	2"	2.1/2"	3"	4"

# Anaconda Sealtite conduit

## HTFGI-316 BLUE



### ROBUST, 'HYGIENICALLY DESIGNED' FOOD GRADE, HIGH TEMPERATURES AND SUPERIOR CORROSION RESISTANT

Type HTFGI-316 is a robust, highly flexible conduit with an AISI-316 stainless steel core and a thick, smooth TPU cover for use on machines and equipment in the food and beverage industry. The hygienically designed conduit cover utilises a microbe inhibiting compound formulated for food and beverage applications per FDA CFR21 requirements and is suitable for use in zones where wash and wipe down frequently take place, including the splash zone. The stainless steel AISI-316 innercore secures an excellent corrosion resistance.

#### Material & Construction:

**Construction:** Stainless steel (AISI-316) core, square locked with cord packing, thick smooth Thermoplastic Polyurethane cover (TPU compound).

From 1.1/2" and 2" a fully inter locked profile will be used.

**Cover specifications:** TPU, halogenfree, lead-free according to RoHS, specially formulated for food and beverage applications per FDA CFR 21 requirements.

**Temperature:** -55 °C till +105 °C, intermittent up to +125 °C.

**Colour:** Blue.



Square locked from 3/8" – 1.1/4"



Inter locked for size 1.1/2" and 2"

#### Classification according to NEN-EN-IEC 61386:

**Compression resistance:** Class 4, Heavy (1250 N).

**Impact resistance:** Class 4, Heavy (6 J).

**Tensile strength:** Class 4, Heavy (1000 N).

**Protection class:** IP 66 / 67 (dust-proof, water-tight).

Sealtite Special

SEALTITE	DIAMETRE		BENDING RADIUS (CL)		STANDARD CARTON		SMALL CARTON		REEL		WEIGHT (kg/m)
	Size (inch)	Inside (mm)	Outside (mm)	Static (mm)	Dynamic (mm)	Metre	Article No. blue	Metre	Article No. blue	Metre	
3/8"	12,6	17,8	60	85	30	351.512.1	-	-	-	-	0,3
1/2"	16	21,1	75	110	30	351.516.1	-	-	-	-	0,4
3/4"	21	26,4	90	140	30	351.520.1	-	-	-	-	0,5
1"	26,5	33,1	120	170	30	351.526.1	-	-	-	-	0,7
1.1/4"	35,1	41,8	135	215	15	351.535.1	-	-	-	-	1,15
1.1/2"	40,3	47,8	165	250	15	351.540.1	-	-	-	-	1,5
2"	51,6	59,9	210	300	15	351.550.1	-	-	-	-	2,15

The fittings for Sealtite are outlined in chapter 5 Sealtite Fittings

SEALTITE	1/4"	5/16"	3/8"	1/2"	3/4"	1"	1.1/4"	1.1/2"	2"	2.1/2"	3"	4"
ISO	M10 - M12	M16 - M20	M16 - M20	M20	M25	M32	M40	M50 - M63	M50 - M63	M75	M90	-
Pg	7	9 - 11	11 - 13,5	16	21	29	36	42	48	-	-	-
NPT	-	-	1/2"	1/2"	3/4"	1"	1.1/4"	1.1/2"	2"	2.1/2"	3"	4"



# Anaconda Sealtite conduit

## TYPE XTHF GREY



### ROBUST, HALOGEN FREE, LOW SMOKE AND VERY WIDE OPERATING TEMPERATURE RANGE

Type XTHF is a robust conduit with a galvanised steel core and a flame retardant, low smoke, halogen free silicone cover for use in applications at very low and/or very high temperatures. At low or high temperatures the conduit retains its flexibility and resistance to UV, sunlight, oil and chemicals. Type XTHF is used in applications where thermal, mechanical and chemical protection for cables on equipment, enclosures and components used in foundries, steelworks and other rigorous environments such as hazardous areas is required.

#### Material & Construction:

**Construction:** Hot dipped galvanised steel core, square locked with integral copper grounding wire, thick smooth thermoplastic (silicone compound, laid-on).  
**Cover specifications:** Silicone, lead-free according to RoHS, UV resistant, low smoke, zero halogen. The cover is good resistant against oil and grease. Flame resistant according to IEC 60614-1, halogen free according to IEC 60614-1.  
**Special tests:** Toxicity according to NES 713 (1,0). Low smoke according to NES 711 Oxygen index 29.2.  
**Temperature:** -70 °C till +200 °C, intermittent up to 260°C.  
**Colour:** Grey.

#### Classification according to NEN-EN-IEC 61386:

**Compression resistance:** Class 4, Heavy (1250 N).  
**Impact resistance:** Class 4, Heavy (6 J).  
**Tensile strength:** Class 4, Heavy (1000 N).  
**Protection class:** IP 66 / 67 (dust-proof, water-tight).



Square locked

SEALTITE	DIAMETRE		BENDING RADIUS (CL)		STANDARD CARTON		SMALL CARTON		REEL		WEIGHT (kg/m)
	Size (inch)	Inside (mm)	Outside (mm)	Static (mm)	Dynamic (mm)	Metre	Article No. grey	Metre	Article No. grey	Metre	
1/2"	16,1	21,1	90	110	30	353.016.1	-	-	-	-	0,45
3/4"	21,1	26,4	115	140	30	353.020.1	-	-	-	-	0,65
1"	26,8	33,1	145	170	30	353.026.1	-	-	-	-	1,05

The fittings for Sealtite are outlined in chapter 5 Sealtite Fittings

SEALTITE	1/4"	5/16"	3/8"	1/2"	3/4"	1"	1.1/4"	1.1/2"	2"	2.1/2"	3"	4"
ISO	M10 - M12	M16 - M20	M16 - M20	M20	M25	M32	M40	M50 - M63	M50 - M63	M75	M90	-
Pg	7	9 - 11	11 - 13,5	16	21	29	36	42	48	-	-	-
NPT	-	-	1/2"	1/2"	3/4"	1"	1.1/4"	1.1/2"	2"	2.1/2"	3"	4"



Sealtite fittings

# Sealtite fittings

# Fitting selection table

## Anaconda / Anamet fittings

FITTING	MATERIAL	TEMPERATURE		THREAD SIZE RANGE			SHIELDING	APPROVALS	PROTECTION	PAGE
		Min.	Max.	ISO	Pg	NPT				
<b>Straight compact</b>	Nickel plated brass	-45 °C	+105 °C	M16 to M90	Pg 11 to Pg 48	1/2" to 3"	++++	   	IP 66 IP 67	5 - 3 till 5 - 9
<b>45° compact</b>	Nickel plated brass	-45 °C	+105 °C	M16 to M75	-	1/2" to 3"	+++	   	IP 66 IP 67	5 - 3 till 5 - 9
<b>90° compact</b>	Nickel plated brass	-45 °C	+105 °C	M16 to M75	Pg 11 to Pg 48	1/2" to 3"	+++	   	IP 66 IP 67	5 - 3 till 5 - 9
<b>Cable-hose</b>	Nickel plated brass	-45 °C	+105 °C	M16 to M40	-	-	+++	 	IP 67 IP 68	5 - 4
<b>Str / 45° / 90° Swivel</b>	Nickel plated brass	-45 °C	+105 °C	M16 to M63	-	1/2" to 1"	+++	 	IP 67	5 - 10 till 5 - 11
<b>Straight</b>	Nickel plated brass	-45 °C	+105 °C	M12 to M63	Pg 7 to Pg 48	1/2" to 2"	+++	   	IP 67	5 - 12 till 5 - 19
<b>45°</b>	Nickel plated brass	-45 °C	+105 °C	M16 to M63	Pg 11 to Pg 48	1/2" to 2"	+++	   	IP 67	5 - 12 till 5 - 19
<b>90°</b>	Nickel plated brass	-45 °C	+105 °C	M16 to M63	Pg 11 to Pg 48	1/2" to 2"	+++	   	IP 67	5 - 12 till 5 - 19
<b>Female</b>	Nickel plated brass	-45 °C	+105 °C	M16 to M63	Pg 11 to Pg 48	1/2" to 2"	+++	   	IP 67	5 - 12 till 5 - 19
<b>Cable-hose (EMC)</b>	Nickel plated brass	-40 °C	+100 °C	M16 to M63	Pg 9 to Pg 29	1/2" to 3/4"	+++	 	IP 67 IP 68	5 - 12 till 5 - 19
<b>Str / 45° / 90° Compact</b>	Stainless steel AISI-304	-45 °C	+105 °C	M16 to M63	-	1/2" to 3"	+++	   	IP 66 IP 67	5 - 20 till 5 - 23
<b>Straight / 45° / 90°</b>	Stainless steel AISI-304	-45 °C	+105 °C	M16 to M50	Pg 11 to Pg 48	1/2" to 1"	+++	   	IP 67	5 - 24 till 5 - 27
<b>Str / 45° / 90° Compact</b>	Stainless steel AISI-316	-45 °C	+105 °C	M16 to M63	-	1/2" to 3"	+++	   	IP 66 IP 67	5 - 28 till 5 - 34
<b>Food Compact Food</b>	Stainless steel AISI-316	-45 °C	+105 °C	M16 to M63	-	-	+++	 	IP 68 IP 69	5 - 35 till 5 - 37
<b>Straight / 90°</b>	Aluminum	-55 °C	+300 °C	-	-	1/2" to 2"	+++	   	IP 67	5 - 38
<b>Straight / 45° / 90°</b>	Galvanised steel	-55 °C	+300 °C	M16 to M32	Pg 11 to Pg 48	1/2" to 4"	+++	   	IP 67	5 - 39 till 5 - 44

# Compact fittings, IP 66 / IP 67, nickel plated brass



## ANACONDA COMPACT FITTINGS, UL & CSA, NICKEL PLATED BRASS, FOR ANACONDA SEALTITE

Anaconda compact nickel plated brass fittings can be used with all types of Anaconda Sealtite conduit with the exception of Type CNP. The Anaconda compact range contains less material, are shorter in length and lighter in weight than the Anaconda standard range of fittings. They are ideal in standard applications and installations where space is limited. The fittings have a flanged ferrule which ensures a secure connection between fitting and conduit. Anaconda compact fittings are UL & CSA approval and are corrosion resistant. The Anaconda range of cable-hose fittings feature a double clamping rubber system which complies with EN45545-2 and are approved for use in the OEM train building industry.

### Material & Construction:

**Construction:** Nickel plated brass fitting, consisting of 4 parts (counter nut, clamping ring, ferrule and body).

**Material:** Counter nut and body are nickel plated brass. Clamping ring is made from PAG and the ferrule is made from galvanised steel. The O-rings are from NBR rubber (black for ISO and blue for Pg). The clamping rubbers of the cable-hose fittings are made from EPDM.

**Special approvals:** UL-514B and CSA C 22.2 (combined UL / CSA (CUL) file # E 234207). Suitable for use in hazardous environments according to NEC:

- Article 501.10 (B) (2) Class I, Division 2.

- Article 502.10 (A) (2) and (B) (2). Class II, Division 1 and 2.

- Article 503.10 (A) (3) and (B). Class III, Division 1 and 2.

\* Sizes 1/4", 5/16", 2.1/2" and 3" do not have UL/CSA approval. The cable-hose fittings have clamping rubbers from flame retardant V0-rated EPDM and are HL 1, HL 2 and HL 3 according EN 45545-2, R22 and R23.

**Temperature:** -45 °C till +105 °C continuous.

**Protection class:** IP 66, IP 67, NEMA 4X.

Cable-hose fittings are IP 68 on the switchbox.

**Colour:** Metal coloured.

Sealtite fittings

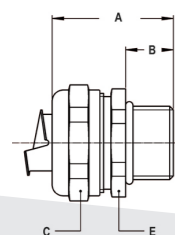

ISO straight fitting, compact, male, nickel plated brass



THREAD ISO	SEALTITE SIZE (INCH)	MIN. INTERNAL BORE (MM)	DIMENSIONS IN MM					STANDARD PACKAGE	ARTICLE NUMBER	WEIGHT (KG/100)
			A	B	C	D	E			
M16 x 1,5	5/16"	8,3	31	10	26	-	24	10	712.015.0*	4,3
M20 x 1,5	5/16"	8,3	31	10	26	-	24	10	712.014.0*	4,4
M16 x 1,5	3/8"	11	31	10	26	-	24	10	712.016.1	3,9
M20 x 1,5	3/8"	11	31	10	26	-	24	10	712.017.1	4
M20 x 1,5	1/2"	14,5	32	10	29	-	27	10	712.020.1	4,4
M25 x 1,5	3/4"	19,4	33	10	35	-	33	5	712.025.1	6,6
M32 x 1,5	1"	24,7	36	12	45	-	42	5	712.032.1	11,7
M40 x 1,5	1.1/4"	33,3	40	13	53	-	50	2	712.040.1	16
M50 x 1,5	1.1/2"	38	46	14	62	-	58	2	712.050.1	25,3
M50 x 1,5	2"	44,0	50	14	76	-	72	2	712.055.1	39,5
M63 x 1,5	2"	49	52	16	76	-	72	2	712.063.1	38,6
M75 x 1,5	2.1/2"	60,7	62	20	90	-	85	1	712.075.1*	74,8
M90 x 2,0	3"	75,5	70	24	108	-	102	1	712.090.1*	107

## COMPACT FITTINGS, IP 66 / IP 67, NICKEL PLATED BRASS

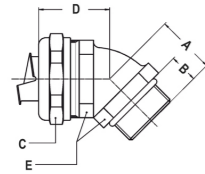
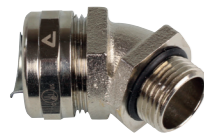

ISO 45° fitting, compact, male, nickel plated brass



THREAD ISO	SEALTITE SIZE (INCH)	MIN. INTERNAL BORE (MM)	DIMENSIONS IN MM					STANDARD PACKAGE	ARTICLE NUMBER	WEIGHT (KG/100)
			A	B	C	D	E			
M16 x 1,5	5/16"	8,3	19	10	26	27	22	10	712.415.0*	6,7
M20 x 1,5	5/16"	8,3	20	10	26	28	24	10	712.414.0*	7,6
M16 x 1,5	3/8"	11	19	10	26	27	22	10	712.416.1	6,3
M20 x 1,5	3/8"	11	20	10	26	28	24	10	712.417.1	7,2
M20 x 1,5	1/2"	14,5	21	10	29	30	27	10	712.420.1	8,3
M25 x 1,5	3/4"	19,4	23	10	35	33	33	5	712.425.1	12,8
M32 x 1,5	1"	24,7	28	12	45	38	42	5	712.432.1	22,5
M40 x 1,5	1.1/4"	33,3	33	13	53	39	52	2	712.440.1	34,5
M50 x 1,5	1.1/2"	38	35	14	62	46	60	2	712.450.1	50
M63 x 1,5	2"	49	40	16	76	53	72	2	712.463.1	80,5
M75 x 1,5	2.1/2"	60,7	51	20	90	65	85	1	712.475.1*	146

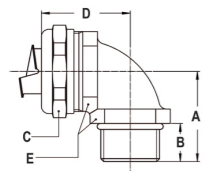

ISO 90° fitting, compact, male, nickel plated brass



THREAD ISO	SEALTITE SIZE (INCH)	MIN. INTERNAL BORE (MM)	DIMENSIONS IN MM					STANDARD PACKAGE	ARTICLE NUMBER	WEIGHT (KG/100)
			A	B	C	D	E			
M16 x 1,5	5/16"	8,3	26	10	26	31	22	10	712.915.0*	7
M20 x 1,5	5/16"	8,3	26	10	26	32	24	10	712.914.0*	8,3
M16 x 1,5	3/8"	11	26	10	26	31	22	10	712.916.1	6,6
M20 x 1,5	3/8"	11	26	10	26	32	24	10	712.917.1	7,9
M20 x 1,5	1/2"	14,5	28	10	29	34	27	10	712.920.1	9,2
M25 x 1,5	3/4"	19,4	32	10	35	40	33	5	712.925.1	16,2
M32 x 1,5	1"	24,7	40	12	45	49	42	5	712.932.1	27,8
M40 x 1,5	1.1/4"	33,3	46	13	53	53	52	2	712.940.1	40,1
M50 x 1,5	1.1/2"	38	52	14	62	57	60	2	712.950.1	57,5
M63 x 1,5	2"	49	62	16	76	68	72	2	712.963.1	90,6
M75 x 1,5	2.1/2"	60,7	75	20	90	87	85	1	712.975.1*	186

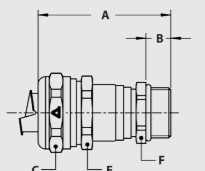

ISO cable-hose fitting, compact, male, nickel plated brass, double EPDM seal according EN 45545-2, HL1 / HL2 / HL3, table R22 and R23



THREAD ISO	SEALTITE SIZE (INCH)	CLAMPING RANGE (MM)	DIMENSIONS IN MM					STANDARD PACKAGE	ARTICLE NUMBER	WEIGHT (KG/100)
			A	B	C	E	F			
M12 x 1,5	1/4"	1,0 - 5,2	46	9	19	17	14	10	712.712.2*	4
M16 x 1,5	1/4"	1,0 - 5,2	47	10	19	17	18	10	712.713.2*	4,7
M16 x 1,5	5/16"	4,0 - 8,3	50	10	22	20	18	10	712.715.2*	5,7
M20 x 1,5	5/16"	4,0 - 8,3	50	10	22	20	22	10	712.714.2*	6,4
M16 x 1,5	3/8"	4,0 - 9,5	50	10	26	24	18	10	712.716.1	6,8
M20 x 1,5	3/8"	4,0 - 9,5	50	10	26	24	22	10	712.717.1	7,4
M20 x 1,5	1/2"	6,0 - 13,0	53	10	29	27	22	10	712.720.1	7,6
M25 x 1,5	1/2"	6,0 - 13,0	54	10	29	27	27	5	712.722.1	9
M25 x 1,5	3/4"	11,0 - 18,0	56	10	35	33	27	5	712.725.1	11,7
M32 x 1,5	3/4"	11,0 - 18,0	58	12	35	33	35	5	712.728.1	15
M32 x 1,5	1"	16,0 - 25,0	61	12	45	42	35	5	712.732.1	20,3
M40 x 1,5	1"	16,0 - 25,0	63	13	45	42	43	2	712.735.1	24,5
M40 x 1,5	1.1/4"	22,0 - 32,0	69	13	53	50	43	2	712.740.1	28,6
M50 x 1,5	1.1/4"	22,0 - 32,0	70	14	53	50	55	1	712.745.1	34,5
M50 x 1,5	1.1/2"	30,0 - 40,0	78	14	62	58	55	1	712.750.1	46,0
M63 x 1,5	1.1/2"	30,0 - 40,0	82	16	62	58	70	1	712.755.1	62
M63 x 1,5	2"	40,0 - 50,0	89	16	76	72	70	1	712.763.1*	81



## COMPACT FITTINGS, IP 66 / IP 67, NICKEL PLATED BRASS

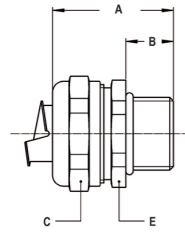

Pg straight fitting, compact, male, nickel plated brass



THREAD PG	SEALTITE SIZE (INCH)	MIN. INTERNAL BORE (MM)	DIMENSIONS IN MM					STANDARD PACKAGE	ARTICLE NUMBER	WEIGHT (KG/100)
			A	B	C	D	E			
Pg 11	5/16"	8,3	31	10	26	-	24	10	710.012.0*	4,4
Pg 13,5	5/16"	8,3	31	10	26	-	24	10	710.014.0*	4,6
Pg 11	3/8"	11	31	10	26	-	24	10	710.011.1	4
Pg 13,5	3/8"	11	31	10	26	-	24	10	710.013.1	4,2
Pg 16	1/2"	14,5	32	10	29	-	27	10	710.016.1	4,5
Pg 21	3/4"	19,4	33	10	35	-	33	5	710.021.1	6,5
Pg 29	1"	24,7	36	12	45	-	44	5	710.029.1	12,2
Pg 36	1.1/4"	33,3	40	13	53	-	52	2	710.036.1	16,4
Pg 42	1.1/2"	38	46	14	62	-	60	2	710.042.1	26,3
Pg 48	2"	49	52	16	76	-	72	2	710.048.1	38,6

\* Sizes 1/4", 5/16", 2.1/2" and 3" do not have UL / CSA approval.

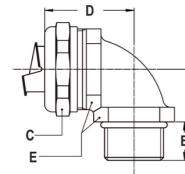

Pg 90° fitting, compact, male, nickel plated brass



Sealtite fittings

THREAD PG	SEALTITE SIZE (INCH)	MIN. INTERNAL BORE (MM)	DIMENSIONS IN MM					STANDARD PACKAGE	ARTICLE NUMBER	WEIGHT (KG/100)
			A	B	C	D	E			
Pg 11	5/16"	8,3	26	10	26	32	24	10	710.912.0*	8,1
Pg 13,5	5/16"	8,3	26	10	26	32	24	10	710.914.0*	8,4
Pg 11	3/8"	11	26	10	26	32	24	10	710.911.1	7,7
Pg 13,5	3/8"	11	26	10	26	32	24	10	710.913.1	8
Pg 16	1/2"	14,5	28	10	29	34	27	10	710.916.1	9,2
Pg 21	3/4"	19,4	32	10	35	40	33	5	710.921.1	15,7
Pg 29	1"	24,7	40	12	45	49	42	5	710.929.1	28,6
Pg 36	1.1/4"	33,3	46	13	53	53	52	2	710.936.1	40,1
Pg 42	1.1/2"	38	52	14	62	57	60	2	710.942.1	57,5
Pg 48	2"	49	62	16	76	68	72	2	710.948.1	92,1

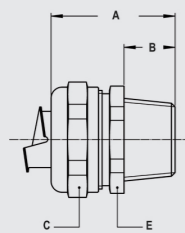

NPT straight fitting, compact, male, nickel plated brass



THREAD NPT	SEALTITE SIZE (INCH)	MIN. INTERNAL BORE (MM)	DIMENSIONS IN MM					STANDARD PACKAGE	ARTICLE NUMBER	WEIGHT (KG/100)
			A	B	C	D	E			
NPT 1/2"	5/16"	8,3	35	14	26	-	24	10	714.011.0*	4,8
NPT 1/2"	3/8"	11	35	14	26	-	24	10	714.012.1	4,4
NPT 1/2"	1/2"	14,5	36	14	29	-	27	10	714.016.1	5
NPT 3/4"	3/4"	19,4	37	14	35	-	33	5	714.020.1	7
NPT 1"	1"	24,7	40	16	45	-	42	5	714.026.1	12,6
NPT 1.1/4"	1.1/4"	33,3	43	16	53	-	50	2	714.035.1	16,8
NPT 1.1/2"	1.1/2"	38	50	18	62	-	58	2	714.040.1	25,8
NPT 2"	2"	49	56	20	76	-	72	2	714.050.1	41,2
NPT 2.1/2"	2.1/2"	60,7	67	25	90	-	85	1	714.063.1*	83,6
NPT 3"	3"	75,5	73	27	108	-	102	1	714.075.1*	113,9

## COMPACT FITTINGS, IP 66 / IP 67, NICKEL PLATED BRASS

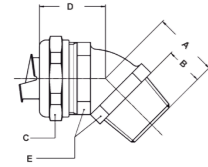

NPT 45° fitting, compact, male, nickel plated brass



THREAD NPT	SEALTITE SIZE (INCH)	MIN. INTERNAL BORE (MM)	DIMENSIONS IN MM					STANDARD PACKAGE	ARTICLE NUMBER	WEIGHT (KG/100)
			A	B	C	D	E			
NPT 1/2"	5/16"	8,3	24	14	26	28	24	10	714.411.0*	8,1
NPT 1/2"	3/8"	11	24	14	26	28	24	10	714.412.1	7,7
NPT 1/2"	1/2"	14,5	25	14	29	30	27	10	714.416.1	8,8
NPT 3/4"	3/4"	19,4	27	14	35	33	33	5	714.420.1	14,5
NPT 1"	1"	24,7	32	16	45	38	42	5	714.426.1	24
NPT 1.1/4"	1.1/4"	33,3	36	16	53	39	52	2	714.435.1	35,5
NPT 1.1/2"	1.1/2"	38	39	18	62	46	60	2	714.440.1	51
NPT 2"	2"	49	44	20	76	53	72	2	714.450.1	85,5
NPT 2.1/2"	2.1/2"	60,7	56	25	90	65	85	1	714.463.1*	155
NPT 3"	3"	75,5	61	27	108	74	102	1	714.475.1*	220

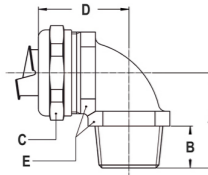

NPT 90° fitting, compact, male, nickel plated brass



THREAD NPT	SEALTITE SIZE (INCH)	MIN. INTERNAL BORE (MM)	DIMENSIONS IN MM					STANDARD PACKAGE	ARTICLE NUMBER	WEIGHT (KG/100)
			A	B	C	D	E			
NPT 1/2"	5/16"	8,3	30	14	26	32	24	10	714.911.0*	8,6
NPT 1/2"	3/8"	11	30	14	26	32	24	10	714.912.1	8,2
NPT 1/2"	1/2"	14,5	32	14	29	34	27	10	714.916.1	9,6
NPT 3/4"	3/4"	19,4	36	14	35	40	33	5	714.920.1	16,7
NPT 1"	1"	24,7	44	16	45	49	42	5	714.926.1	28,3
NPT 1.1/4"	1.1/4"	33,3	49	16	53	53	52	2	714.935.1	41,4
NPT 1.1/2"	1.1/2"	38	56	18	62	57	60	2	714.940.1	57,3
NPT 2"	2"	49	66	20	76	68	72	2	714.950.1	90,8
NPT 2.1/2"	2.1/2"	60,7	80	25	90	87	85	1	714.963.1*	198
NPT 3"	3"	75,5	92	27	108	97	102	1	714.975.1*	289

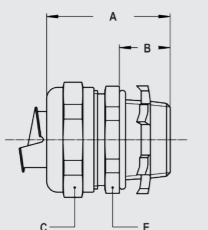

NPT straight fitting, compact, male, nickel plated brass  
(including flat seal and locknut)



THREAD NPT	SEALTITE SIZE (INCH)	MIN. INTERNAL BORE (MM)	DIMENSIONS IN MM					STANDARD PACKAGE	ARTICLE NUMBER	WEIGHT (KG/100)
			A	B	C	D	E			
NPT 1/2"	5/16"	8,3	35	14	26	-	24	10	714.011.2*	5,3
NPT 1/2"	3/8"	11	35	14	26	-	24	10	714.012.2	4,9
NPT 1/2"	1/2"	14,5	36	14	29	-	27	10	714.016.2	5,5
NPT 3/4"	3/4"	19,4	37	14	35	-	33	5	714.020.2	7,8
NPT 1"	1"	24,7	40	16	45	-	42	5	714.026.2	13,9
NPT 1.1/4"	1.1/4"	33,3	43	16	53	-	50	2	714.035.2	18,6
NPT 1.1/2"	1.1/2"	38	50	18	62	-	58	2	714.040.2	28
NPT 2"	2"	49	56	20	76	-	72	2	714.050.2	45
NPT 2.1/2"	2.1/2"	60,7	67	25	90	-	85	1	714.063.2*	87,1
NPT 3"	3"	75,5	73	27	108	-	102	1	714.075.2*	119,5

\* Sizes 1/4", 5/16", 2.1/2" and 3" do not have UL / CSA approval.

## COMPACT FITTINGS, IP 66 / IP 67, NICKEL PLATED BRASS

NPT 45° fitting, compact, male, nickel plated brass  
(including flat seal and locknut)

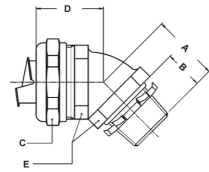

THREAD NPT	SEALTITE SIZE (INCH)	MIN. INTERNAL BORE (MM)	DIMENSIONS IN MM					STANDARD PACKAGE	ARTICLE NUMBER	WEIGHT (KG/100)
			A	B	C	D	E			
NPT 1/2"	5/16"	8,3	24	14	26	28	24	10	714.411.2*	8,6
NPT 1/2"	3/8"	11	24	14	26	28	24	10	714.412.2	8,2
NPT 1/2"	1/2"	14,5	25	14	29	30	27	10	714.416.2	9,3
NPT 3/4"	3/4"	19,4	27	14	35	33	33	5	714.420.2	15,3
NPT 1"	1"	24,7	32	16	45	38	42	5	714.426.2	25,3
NPT 1.1/4"	1.1/4"	33,3	36	16	53	39	52	2	714.435.2	37,3
NPT 1.1/2"	1.1/2"	38	39	18	62	46	60	2	714.440.2	53,2
NPT 2"	2"	49	44	20	76	53	72	2	714.450.2	88,3
NPT 2.1/2"	2.1/2"	60,7	56	25	90	65	85	1	714.463.2*	158,3
NPT 3"	3"	75,5	61	27	108	74	102	1	714.475.2*	225,6

\* Sizes 1/4", 5/16", 2.1/2" and 3" do not have UL / CSA approval.

NPT 90° fitting, compact, male, nickel plated brass  
(including flat seal and locknut)

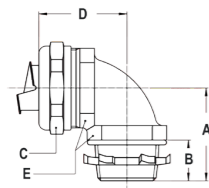

THREAD NPT	SEALTITE SIZE (INCH)	MIN. INTERNAL BORE (MM)	DIMENSIONS IN MM					STANDARD PACKAGE	ARTICLE NUMBER	WEIGHT (KG/100)
			A	B	C	D	E			
NPT 1/2"	5/16"	8,3	30	14	26	32	24	10	714.911.2*	9,1
NPT 1/2"	3/8"	11	30	14	26	32	24	10	714.912.2	8,7
NPT 1/2"	1/2"	14,5	32	14	29	34	27	10	714.916.2	10,1
NPT 3/4"	3/4"	19,4	36	14	35	40	33	5	714.920.2	17,5
NPT 1"	1"	24,7	44	16	45	49	42	5	714.926.2	29,6
NPT 1.1/4"	1.1/4"	33,3	49	16	53	53	52	2	714.935.2	43,2
NPT 1.1/2"	1.1/2"	38	56	18	62	57	60	2	714.940.2	59,5
NPT 2"	2"	49	66	20	76	68	72	2	714.950.2	93,6
NPT 2.1/2"	2.1/2"	60,7	80	25	90	87	85	1	714.963.2*	201,5
NPT 3"	3"	75,5	92	27	108	97	102	1	714.975.2*	294,6

\* Sizes 1/4", 5/16", 2.1/2" and 3" do not have UL / CSA approval.

NPT cable-hose fitting, compact, male, nickel plated brass, double  
EPDM seal according EN 45545-2, HL1 / HL2 / HL3, table R22  
and R23 incl. NBR flat seal and galvanised steel locknut

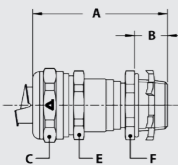

THREAD NPT	SEALTITE SIZE (INCH)	CLAMPING RANGE (MM)	DIMENSIONS IN MM					STANDARD PACKAGE	ARTICLE NUMBER	WEIGHT (KG/100)
			A	B	C	E	F			
NPT 1/2"	3/8"	4,0 - 9,5	54	14	26	24	24	10	714.712.2	8,0
NPT 1/2"	1/2"	6,0 - 13,0	57	14	29	27	24	10	714.716.2	8,9
NPT 3/4"	1/2"	6,0 - 13,0	58	14	29	27	30	5	714.718.2	10,3
NPT 3/4"	3/4"	10,5 - 18,0	60	14	35	33	30	5	714.720.2	13,2
NPT 1"	3/4"	10,5 - 18,0	62	16	35	33	38	5	714.723.2	16,5
NPT 1"	1"	16,0 - 24,7	65	16	45	42	38	5	714.726.2	22,2
NPT 1.1/4"	1"	16,0 - 24,7	66	16	45	42	48	2	714.730.2	26,4
NPT 1.1/4"	1.1/4"	22,0 - 32,0	72	16	53	50	48	2	714.735.2	31,8
NPT 1.1/2"	1.1/4"	22,0 - 32,0	74	18	53	50	55	1	714.738.2	36,5
NPT 1.1/2"	1.1/2"	29,5 - 38,0	92	18	62	58	55	1	714.740.2	53,0

Sealtite fittings

## COMPACT FITTINGS, IP 66 / IP 67, NICKEL PLATED BRASS

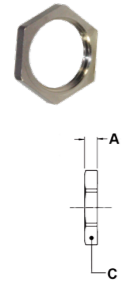

ISO lock nuts, nickel plated brass



THREAD ISO	SEALTITE SIZE (INCH)	MIN. INTERNAL BORE (MM)	DIMENSIONS IN MM					STANDARD PACKAGE	ARTICLE NUMBER	WEIGHT (KG/100)
			A	B	C	D	E			
M16 x 1,5	-	-	3	-	20	-	-	50	880.116.0	0,4
M20 x 1,5	-	-	3,5	-	24	-	-	50	880.120.0	0,6
M25 x 1,5	-	-	3,5	-	30	-	-	25	880.125.0	0,9
M32 x 1,5	-	-	4,5	-	35	-	-	20	880.132.0	2,2
M40 x 1,5	-	-	4,5	-	45	-	-	10	880.140.0	3,2
M50 x 1,5	-	-	5,5	-	55	-	-	10	880.150.0	5
M63 x 1,5	-	-	6	-	70	-	-	5	880.163.0	5,6
M75 x 1,5	-	-	7	-	80	-	-	5	880.175.0	-
M90 x 2,0	-	-	8	-	100	-	-	5	880.190.0	-



Neoprene sealing gasket for ISO



THREAD ISO	THREAD PG	THREAD NPT	DIMENSIONS IN MM					STANDARD PACKAGE	ARTICLE NUMBER	WEIGHT (KG/100)
			A	B	C	D	E			
M16 x 1,5	-	-	1,2	-	20	14	-	100	815.416.0	0,03
M20 x 1,5	-	-	1,2	-	24	18	-	100	815.420.0	0,03
M25 x 1,5	-	-	1,2	-	30	23	-	50	815.425.0	0,05
M32 x 1,5	-	-	1,2	-	40	30	-	50	815.432.0	0,11
M40 x 1,5	-	-	1,2	-	48	38	-	50	815.440.0	0,15
M50 x 1,5	-	-	1,2	-	58	48	-	50	815.450.0	0,19
M63 x 1,5	-	-	1,2	-	75	61	-	50	815.463.0	0,33



Pg lock nuts, nickel plated brass



THREAD PG	SEALTITE SIZE (INCH)	MIN. INTERNAL BORE (MM)	DIMENSIONS IN MM					STANDARD PACKAGE	ARTICLE NUMBER	WEIGHT (KG/100)
			A	B	C	D	E			
Pg 7	-	-	2,9	-	15	-	-	50	880.007.0	0,2
Pg 9	-	-	2,9	-	18	-	-	50	880.009.0	0,2
Pg 11	-	-	2,9	-	21	-	-	50	880.011.0	0,3
Pg 13,5	-	-	3,1	-	23	-	-	50	880.013.0	0,4
Pg 16	-	-	3,1	-	26	-	-	50	880.016.0	0,5
Pg 21	-	-	3,6	-	32	-	-	20	880.021.0	0,8
Pg 29	-	-	4,1	-	41	-	-	20	880.029.0	1,4
Pg 36	-	-	5,1	-	51	-	-	10	880.036.0	2,1
Pg 42	-	-	5,1	-	60	-	-	5	880.042.0	3,6
Pg 48	-	-	5,6	-	64	-	-	5	880.048.0	4,1

## COMPACT FITTINGS, IP 66 / IP 67, NICKEL PLATED BRASS

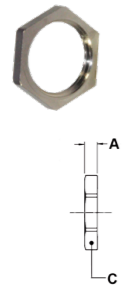

NPT lock nuts, nickel plated brass



THREAD NPT	SEALTITE SIZE (INCH)	MIN. INTERNAL BORE (MM)	DIMENSIONS IN MM					STANDARD PACKAGE	ARTICLE NUMBER	WEIGHT (KG/100)
			A	B	C	D	E			
NPT 1/2"	-	-	4	-	27	-	-	50	880.216.0	1,1
NPT 3/4"	-	-	4,5	-	32	-	-	25	880.220.0	1,4
NPT 1"	-	-	6	-	38	-	-	25	880.226.0	2,1
NPT 1.1/4"	-	-	6,5	-	48	-	-	5	880.235.0	3,5
NPT 1.1/2"	-	-	7	-	55	-	-	5	880.240.0	5
NPT 2"	-	-	7,5	-	70	-	-	5	880.250.0	8,8



Grounding ferrule, galvanised steel



THREAD	SEALTITE SIZE (INCH)	MIN. INTERNAL BORE (MM)	DIMENSIONS IN MM					STANDARD PACKAGE	ARTICLE NUMBER	WEIGHT (KG/100)
			A	B	C	D	E			
-	3/8"	11	-	-	-	-	-	50	815.011.2	0,4
-	1/2"	14,5	-	-	-	-	-	50	815.016.2	0,5
-	3/4"	19,4	-	-	-	-	-	25	815.021.2	0,7
-	1"	24,7	-	-	-	-	-	25	815.029.2	1,1
-	1.1/4"	33,3	-	-	-	-	-	10	815.036.2	1,5
-	1.1/2"	38	-	-	-	-	-	10	815.042.2	2,1
-	2"	49	-	-	-	-	-	10	815.048.2	3,2
-	2.1/2"	60,7	-	-	-	-	-	5	815.063.2	4,3
-	3"	75,5	-	-	-	-	-	5	815.075.2	5,9

Sealtite  
fittings



# Swivel fittings, IP 67, nickel plated brass

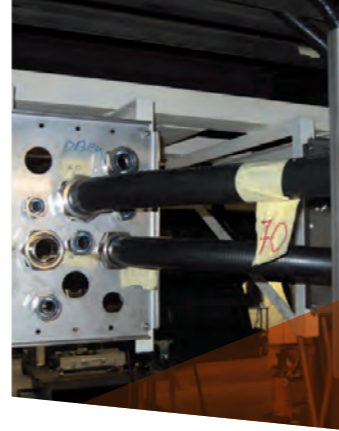

## ANACONDA SWIVEL FITTINGS, NICKEL PLATED BRASS, FOR ANACONDA SEALTITE

Anaconda nickel plated brass swivel fittings can be used with all types of Anaconda SealTite conduit with the exception of Type CNP. These fittings feature a special swivel mechanism which eliminates torque tension at the conduit and fitting interface, allowing easy installation. All ferrules are turned nickel plated brass, waterproof IP 67 rated and are corrosion resistant.

### Material & Construction:

**Construction:** Nickel plated brass fitting, consisting of 4 parts (counter nut, clamping ring, ferrule and body).

**Material:** Counter nut and body are nickel plated brass. Clamping ring is made from PAG and the ferrule is made from nickel plated brass. The O-rings are from NBR rubber (black for ISO).

**Temperature:** -45 °C till +105 °C continuous.

**Protection class:** IP 67.

**Colour:** Metal coloured.

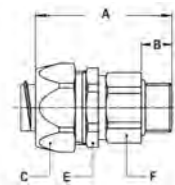

ISO straight swivel fitting, male, nickel plated brass



THREAD ISO	SEALTITE SIZE (INCH)	MIN. INTERNAL BORE (MM)	DIMENSIONS IN MM					STANDARD PACKAGE	ARTICLE NUMBER	WEIGHT (KG/100)
			A	B	C	E	F			
M16 x 1,5	5/16"	8,3	48	10	26	24	21	10	813.015.0	8,1
M16 x 1,5	3/8"	10,4	48	10	26	24	21	10	813.016.0	8,1
M20 x 1,5	3/8"	10,4	49	10	26	25	25	10	813.017.0	8,9
M20 x 1,5	1/2"	13,8	49	10	29	27	25	10	813.020.0	10,2
M25 x 1,5	3/4"	17,4	49	10	35	33	31	5	813.025.0	13,8
M32 x 1,5	1"	23,4	55	12	45	42	38	5	813.032.0	32,5
M40 x 1,5	1.1/4"	29,4	58	14	54	50	48	2	813.040.0	53
M50 x 1,5	1.1/2"	36,9	65	14	62	58	55	2	813.050.0	74
M63 x 1,5	2"	47,9	74	16	76	72	68	2	813.063.0	130

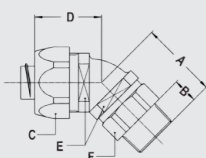

ISO 45° swivel fitting, male, nickel plated brass



THREAD ISO	SEALTITE SIZE (INCH)	MIN. INTERNAL BORE (MM)	DIMENSIONS IN MM						STANDARD PACKAGE	ARTICLE NUMBER	WEIGHT (KG/100)
			A	B	C	D	E	F			
M16 x 1,5	5/16"	8,3	34	10	26	28	22	21	10	813.415.0	9,9
M16 x 1,5	3/8"	10,4	34	10	26	28	22	21	10	813.416.0	9,5
M20 x 1,5	1/2"	13,8	34	10	29	30	27	25	10	813.420.0	13,5
M25 x 1,5	3/4"	17,4	37	10	35	32	33	31	5	813.425.0	21,5
M32 x 1,5	1"	23,4	41	12	45	37	42	38	5	813.432.0	36,5

## SWIVEL FITTINGS, IP 67, NICKEL PLATED BRASS

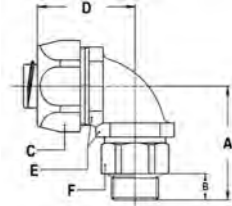

ISO 90° swivel fitting, male, nickel plated brass



THREAD ISO	SEALTITE SIZE (INCH)	MIN. INTERNAL BORE (MM)	DIMENSIONS IN MM						STANDARD PACKAGE	ARTICLE NUMBER	WEIGHT (KG/100)
			A	B	C	D	E	F			
M16 x 1,5	5/16"	8,3	39	10	26	35	22	22	10	813.915.0	11,2
M16 x 1,5	3/8"	10,4	39	10	26	35	22	22	10	813.916.0	10,8
M20 x 1,5	1/2"	13,8	39	10	29	37	27	25	10	813.920.0	13,2
M25 x 1,5	3/4"	17,4	46	10	35	44	33	31	5	813.925.0	22,8
M32 x 1,5	1"	23,4	55	12	45	55	42	38	5	813.932.0	41,4

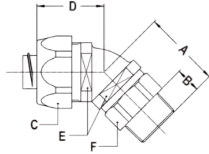

NPT 45° swivel fitting, male, nickel plated brass



Sealtite fittings

THREAD NPT	SEALTITE SIZE (INCH)	MIN. INTERNAL BORE (MM)	DIMENSIONS IN MM						STANDARD PACKAGE	ARTICLE NUMBER	WEIGHT (KG/100)
			A	B	C	D	E	F			
NPT 1/2"	5/16"	8,3	36	12	26	28	22	22	10	819.411.0	11,9
NPT 1/2"	3/8"	10,4	36	12	26	28	22	22	10	819.412.0	11,5
NPT 1/2"	1/2"	13,8	36	12	29	30	27	25	10	819.416.0	14
NPT 3/4"	3/4"	17,4	39	12	35	32	33	31	5	819.420.0	22
NPT 1"	1"	23,4	42	13	45	37	42	38	5	819.426.0	37

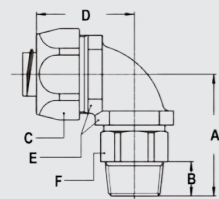

NPT 90° swivel fitting, male, nickel plated brass



THREAD NPT	SEALTITE SIZE (INCH)	MIN. INTERNAL BORE (MM)	DIMENSIONS IN MM						STANDARD PACKAGE	ARTICLE NUMBER	WEIGHT (KG/100)
			A	B	C	D	E	F			
NPT 1/2"	5/16"	8,3	41	12	26	35	22	22	10	819.911.0	12,4
NPT 1/2"	3/8"	10,4	41	12	26	35	22	22	10	819.912.0	12
NPT 1/2"	1/2"	13,8	41	12	29	37	27	25	10	819.916.0	14
NPT 3/4"	3/4"	17,4	48	12	35	44	33	31	5	819.920.0	23,5
NPT 1"	1"	23,4	56	13	45	55	42	38	5	819.926.0	42,0

# Standard fittings, IP 67, nickel plated brass



## ANACONDA NICKEL PLATED BRASS FITTINGS FOR ANACONDA SEALTITE

Anaconda standard nickel plated brass fittings can be used with all types of Anaconda Sealtite (except CNP). This Anaconda fitting is an universal fitting and offers excellent corrosion protection in combination with a nice appearance. Because of the UL & CSA approvals the fittings are also suitable for export projects outside Europe.

### Material & Construction:

**Construction:** Nickel plated brass fitting, consisting of 4 parts (counter nut, clamping ring, ferrule and body).

**Material:** Counter nut, body and ferrule are nickel plated brass with exception of size 3/8" till 1" where the ferrule is from galvanised steel. Clamping ring and inserts are made from PA6 (red for ISO metric, blue for Pg and white for NPT).

**Special approvals:** UL-514B and CSA C 22.2 (combined UL / CSA CUL) file # E 234207).

Suitable for use in hazardous environments according to NEC:

- Article 501.10 (B) (2) Class I, Division 2.

- Article 502.10 (A) (2) and (B) (2). Class II, Division 1 and 2.

- Article 503.10 (A) (3) and (B). Class III, Division 1 and 2.

**Temperature:** -45 °C till +105 °C continuous (cable-hose fittings are -40 °C till +100 °C).

**Protection class:** IP 67, with cable-hose fittings an IP 68 rate on the switchbox can be obtained.

**Colour:** Metal coloured.

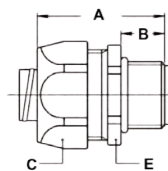

ISO straight fitting, male, nickel plated brass



THREAD ISO	SEALTITE SIZE (INCH)	MIN. INTERNAL BORE (MM)	DIMENSIONS IN MM					STANDARD PACKAGE	ARTICLE NUMBER	WEIGHT (KG/100)
			A	B	C	D	E			
M12 x 1,5	1/4"	5,2	33	10	22	-	20	10	812.012.1*	4,8
M16 x 1,5	5/16"	8,3	35	12	26	-	24	10	812.015.1*	5,2
M20 x 1,5	5/16"	8,3	36	13	26	-	24	10	812.014.1*	5,5
M16 x 1,5	3/8"	10,2	35	12	26	-	24	10	812.016.1	4,8
M20 x 1,5	3/8"	10,2	36	13	26	-	24	10	812.017.1	5,1
M20 x 1,5	1/2"	13,9	37	13	29	-	27	10	812.020.1	5,9
M25 x 1,5	3/4"	18,5	40	15	35	-	33	5	812.025.1	7,9
M32 x 1,5	1"	23,8	46	15	45	-	43	5	812.032.1	17,5
M40 x 1,5	1.1/4"	31,8	52	16	54	-	52	2	812.040.1	27,9
M50 x 1,5	1.1/2"	36,8	56	18	63	-	60	2	812.050.1	42,3
M63 x 1,5	2"	47,8	66	20	77	-	74	2	812.063.1	73,5

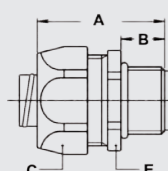

ISO straight fitting, small design, male, nickel plated brass



THREAD ISO	SEALTITE SIZE (INCH)	MIN. INTERNAL BORE (MM)	DIMENSIONS IN MM					STANDARD PACKAGE	ARTICLE NUMBER	WEIGHT (KG/100)
			A	B	C	D	E			
M12 x 1,5	1/4"	5,2	33	10	19	-	17	10	812.012.2	2,8
M16 x 1,5	1/4"	5,2	35	12	19	-	19	10	812.013.2	3,4
M12 x 1,5	5/16"	8,3	33	10	22	-	20	10	812.011.2	3,6
M16 x 1,5	5/16"	8,3	35	12	22	-	20	10	812.015.2	3,8
M20 x 1,5	5/16"	8,3	36	13	22	-	24	10	812.014.2	4,2

\* Sizes 1/4" and 5/16" do not have UL / CSA approval.

## STANDARD FITTINGS, IP 67, NICKEL PLATED BRASS

ISO straight fitting, female, nickel plated brass

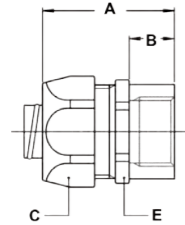

THREAD ISO	SEALTITE SIZE (INCH)	MIN. INTERNAL BORE (MM)	DIMENSIONS IN MM					STANDARD PACKAGE	ARTICLE NUMBER	WEIGHT (KG/100)
			A	B	C	D	E			
M16 x 1,5	5/16"	8,3	35	12	26	-	24	10	812.315.1*	5,4
M16 x 1,5	3/8"	10,2	35	12	26	-	24	10	812.316.1	5
M20 x 1,5	1/2"	13,9	37	13	29	-	27	10	812.320.1	7,6
M25 x 1,5	3/4"	18,5	40	15	35	-	33	5	812.325.1	9
M32 x 1,5	1"	23,8	46	15	45	-	43	5	812.332.1	18,3
M40 x 1,5	1.1/4"	31,8	52	16	54	-	52	2	812.340.1	29,3
M50 x 1,5	1.1/2"	36,8	56	18	63	-	60	2	812.350.1	41,2
M63 x 1,5	2"	47,8	66	20	77	-	74	2	812.363.1	71,8

ISO 45° fitting, male, nickel plated brass

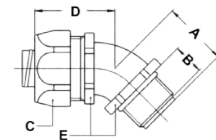

THREAD ISO	SEALTITE SIZE (INCH)	MIN. INTERNAL BORE (MM)	DIMENSIONS IN MM					STANDARD PACKAGE	ARTICLE NUMBER	WEIGHT (KG/100)
			A	B	C	D	E			
M16 x 1,5	5/16"	8,3	23	12	26	33	22	10	812.415.1*	7,7
M20 x 1,5	5/16"	8,3	24	13	26	33	22	10	812.414.1*	7,8
M16 x 1,5	3/8"	10,2	23	12	26	33	22	10	812.416.1	7,3
M20 x 1,5	3/8"	10,2	24	13	26	33	22	10	812.417.1	7,4
M20 x 1,5	1/2"	13,9	25	13	29	33	27	10	812.420.1	10,5
M25 x 1,5	3/4"	18,5	30	15	35	36	33	5	812.425.1	13,6
M32 x 1,5	1"	23,8	34	15	45	46	42	5	812.432.1	26,5
M40 x 1,5	1.1/4"	31,8	39	16	54	54	51	2	812.440.1	44,9
M50 x 1,5	1.1/2"	36,8	45	18	63	59	60	2	812.450.1	67,5
M63 x 1,5	2"	47,8	53	20	77	71	74	2	812.463.1	128

Sealtite fittings

ISO 90° fitting, male, nickel plated brass

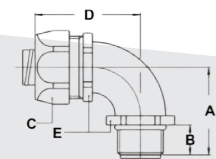

THREAD ISO	SEALTITE SIZE (INCH)	MIN. INTERNAL BORE (MM)	DIMENSIONS IN MM					STANDARD PACKAGE	ARTICLE NUMBER	WEIGHT (KG/100)
			A	B	C	D	E			
M16 x 1,5	5/16"	8,3	32	12	26	42	22	10	812.915.1*	8,6
M20 x 1,5	5/16"	8,3	33	13	26	42	22	10	812.914.1*	8,8
M16 x 1,5	3/8"	10,2	32	12	26	42	22	10	812.916.1	8,2
M20 x 1,5	3/8"	10,2	33	13	26	42	22	10	812.917.1	8,4
M20 x 1,5	1/2"	13,9	36	13	29	43	27	10	812.920.1	12,6
M25 x 1,5	3/4"	18,5	43	15	35	48	33	5	812.925.1	19,2
M32 x 1,5	1"	23,8	48	15	45	59	42	5	812.932.1	31,6
M40 x 1,5	1.1/4"	31,8	57	16	54	68	51	2	812.940.1	56,1
M50 x 1,5	1.1/2"	36,8	63	18	63	78	60	2	812.950.1	85,3
M63 x 1,5	2"	47,8	74	20	77	96	74	2	812.963.1	139,8

\* Sizes 1/4" and 5/16" do not have UL / CSA approval.

## STANDARD FITTINGS, IP 67, NICKEL PLATED BRASS

ISO cable-hose fitting, male, nickel plated brass

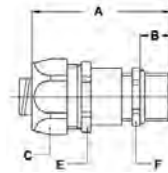

THREAD ISO	SEALTITE SIZE (INCH)	CLAMPING RANGE (MM)	DIMENSIONS IN MM					STANDARD PACKAGE	ARTICLE NUMBER	WEIGHT (KG/100)
			A	B	C	E	F			
M16 x 1,5	5/16"	4 - 8	57	12	26	24	18	10	812.715.2	5,2
M16 x 1,5	3/8"	4 - 8	57	12	26	24	18	10	812.716.1	7,8
M20 x 1,5	3/8"	6 - 10,2	57	12	26	24	22	10	812.717.1	9,5
M20 x 1,5	1/2"	6 - 12	59	12	29	27	22	10	812.720.1	9,7
M25 x 1,5	1/2"	10 - 13,9	62	12	29	27	27	10	812.722.1	11,7
M32 x 1,5	3/4"	13 - 18	70	15	35	33	34	5	812.728.1	20,2
M40 x 1,5	1"	18 - 23,5	83	15	45	43	43	2	812.735.1	32,6
M40 x 1,5	1.1/4"	22 - 31,5	96	15	54	52	43	2	812.740.1	46
M50 x 1,5	1.1/4"	22 - 31,8	96	15	54	52	55	2	812.745.1	60

ISO, EMC cable-hose fitting, male, nickel plated brass

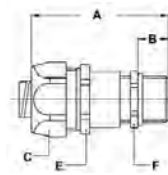

THREAD ISO	SEALTITE SIZE (INCH)	CLAMPING RANGE (MM)	DIMENSIONS IN MM					STANDARD PACKAGE	ARTICLE NUMBER	WEIGHT (KG/100)
			A	B	C	E	F			
M16 x 1,5	5/16"	4 - 8	57	12	26	24	18	10	812.615.2	5,2
M16 x 1,5	3/8"	4 - 8	57	12	26	24	18	10	812.616.1	7,8
M20 x 1,5	3/8"	6 - 10,2	57	12	26	24	22	10	812.617.1	9,5
M20 x 1,5	1/2"	6 - 12	59	12	29	27	22	10	812.620.1	9,7
M25 x 1,5	1/2"	10 - 13,9	62	12	29	27	27	5	812.622.1	11,7
M32 x 1,5	3/4"	13 - 18	70	15	35	33	34	5	812.628.1	19,6
M40 x 1,5	1"	18 - 23,8	83	15	45	43	43	2	812.635.1	35,4

ISO cable-hose fitting, with extended clamping range, male, nickel plated brass

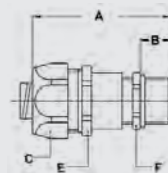

THREAD ISO	SEALTITE SIZE (INCH)	CLAMPING RANGE (MM)	DIMENSIONS IN MM					STANDARD PACKAGE	ARTICLE NUMBER	WEIGHT (KG/100)
			A	B	C	E	F			
M16 x 1,5	3/8"	3 - 10,2	64	12	26	24	20	10	812.716.2	8,2
M20 x 1,5	1/2"	7 - 13,9	64	12	29	27	24	10	812.720.2	10,2
M25 x 1,5	3/4"	9 - 18,0	77	15	35	33	30	5	812.725.2	17
M32 x 1,5	1"	13 - 23,8	88	15	45	43	40	5	812.732.2	31
M40 x 1,5	1.1/4"	20 - 31,8	102	15	54	52	50	2	812.740.2	54,6
M50 x 1,5	1.1/2"	21 - 36,8	106	18	63	60	58	2	812.750.2	76,6
M63 x 1,5	2"	27 - 44,0	116	18	77	74	68	2	812.763.2	116,6



## STANDARD FITTINGS, IP 67, NICKEL PLATED BRASS



Multiple hole seals for cable-hose fittings with extended range



THREAD ISO	SEALTITE SIZE (INCH)	HOLES X DIAM	DIMENSIONS IN MM					STANDARD PACKAGE	ARTICLE NUMBER	WEIGHT (KG/100)
			A	B	C	D	E			
M20 x 1,5	1/2"	3 x 4,0	-	-	-	-	-	100	785.234.0*	-
M20 x 1,5	1/2"	3 x 5,0	-	-	-	-	-	100	785.235.0*	-
M20 x 1,5	1/2"	4 x 3,0	-	-	-	-	-	100	785.243.0*	-
M20 x 1,5	1/2"	4 x 4,0	-	-	-	-	-	100	785.244.0*	-
M25 x 1,5	3/4"	2 x 7,0	-	-	-	-	-	100	785.327.0	-
M25 x 1,5	3/4"	3 x 6,6	-	-	-	-	-	100	785.336.6	-
M25 x 1,5	3/4"	3 x 8,0	-	-	-	-	-	100	785.338.0	-
M32 x 1,5	1"	3 x 7,5	-	-	-	-	-	100	785.437.5	-
M32 x 1,5	1"	4 x 8,0	-	-	-	-	-	100	785.448.0	-
M32 x 1,5	1"	6 x 5,0	-	-	-	-	-	100	785.465.0	-
M32 x 1,5	1"	6 x 6,0	-	-	-	-	-	100	785.466.0	-

\* The seals for M20x1,5 are for the cable-hose fittings in the standard range (pn 812.717.1 or 812.720.1)

\*\* Other (not mentioned hole patterns) are available on request. The multiple hole seals will be delivered separately.

Sealtite fittings

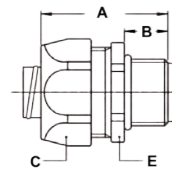

Pg straight fitting, male, nickel plated brass



THREAD PG	SEALTITE SIZE (INCH)	MIN. INTERNAL BORE (MM)	DIMENSIONS IN MM					STANDARD PACKAGE	ARTICLE NUMBER	WEIGHT (KG/100)
			A	B	C	D	E			
Pg 7	1/4"	5,2	33	10	22	-	20	10	810.007.1*	3
Pg 9	5/16"	8,3	35	12	26	-	24	10	810.009.1*	5,2
Pg 11	5/16"	8,3	35	12	26	-	24	10	810.012.1*	6
Pg 13,5	5/16"	8,3	35	12	26	-	24	10	810.014.1*	6
Pg 9	3/8"	10,2	35	12	26	-	24	10	810.010.1*	4,8
Pg 11	3/8"	10,2	35	12	26	-	24	10	810.011.1	5,6
Pg 13,5	3/8"	10,2	35	12	26	-	24	10	810.013.1	5,6
Pg 16	1/2"	13,9	37	13	29	-	27	10	810.016.1	6,3
Pg 21	3/4"	18,5	40	15	35	-	33	5	810.021.1	8,4
Pg 29	1"	23,8	46	15	45	-	43	5	810.029.1	25
Pg 36	1.1/4"	31,8	52	16	54	-	52	2	810.036.1	34,6
Pg 42	1.1/2"	36,8	56	18	63	-	60	2	810.042.1	47,2
Pg 48	2"	47,8	66	20	77	-	74	2	810.048.1	72

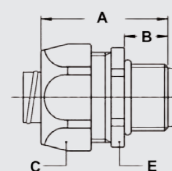

Pg straight fitting, small design, male, nickel plated brass



THREAD PG	SEALTITE SIZE (INCH)	MIN. INTERNAL BORE (MM)	DIMENSIONS IN MM					STANDARD PACKAGE	ARTICLE NUMBER	WEIGHT (KG/100)
			A	B	C	D	E			
Pg 7	1/4"	5,2	33	10	19	-	17	10	810.007.2	2,8
Pg 9	5/16"	8,3	35	12	22	-	20	10	810.009.2	3,8

\* Sizes 1/4" and 5/16" do not have UL / CSA approval.

## STANDARD FITTINGS, IP 67, NICKEL PLATED BRASS

Pg straight fitting, female, nickel plated brass

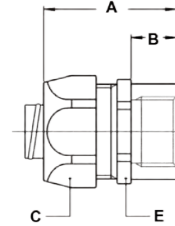

THREAD PG	SEALTITE SIZE (INCH)	MIN. INTERNAL BORE (MM)	DIMENSIONS IN MM					STANDARD PACKAGE	ARTICLE NUMBER	WEIGHT (KG/100)
			A	B	C	D	E			
Pg 11	5/16"	8,3	35	12	26	-	24	10	810.312.1*	5,7
Pg 13,5	5/16"	8,3	35	12	26	-	24	10	810.314.1*	5,7
Pg 11	3/8"	10,2	35	12	26	-	24	10	810.311.1	5,3
Pg 13,5	3/8"	10,2	35	12	26	-	24	10	810.313.1	5,3
Pg 16	1/2"	13,9	37	13	29	-	27	10	810.316.1	6,3
Pg 21	3/4"	18,5	40	15	35	-	33	5	810.321.1	9,3
Pg 29	1"	23,8	46	15	45	-	43	5	810.329.1	20,7
Pg 36	1.1/4"	31,8	52	16	54	-	52	2	810.336.1	29,3
Pg 42	1.1/2"	36,8	56	18	63	-	60	2	810.342.1	43,2
Pg 48	2"	47,8	66	20	77	-	74	2	810.348.1	74,8

Pg 45° fitting, male, nickel plated brass

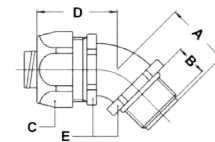

THREAD PG	SEALTITE SIZE (INCH)	MIN. INTERNAL BORE (MM)	DIMENSIONS IN MM					STANDARD PACKAGE	ARTICLE NUMBER	WEIGHT (KG/100)
			A	B	C	D	E			
Pg 11	5/16"	8,3	23	12	26	33	22	10	810.412.1*	8,5
Pg 13,5	5/16"	8,3	23	12	26	33	22	10	810.414.1*	8,5
Pg 11	3/8"	10,2	23	12	26	33	22	10	810.411.1	8,1
Pg 13,5	3/8"	10,2	23	12	26	33	22	10	810.413.1	8,1
Pg 16	1/2"	13,9	25	13	29	33	27	10	810.416.1	11,6
Pg 21	3/4"	18,5	30	15	35	36	33	5	810.421.1	15,3
Pg 29	1"	23,8	34	15	45	46	42	5	810.429.1	31,5
Pg 36	1.1/4"	31,8	39	16	54	54	51	2	810.436.1	53,2
Pg 42	1.1/2"	36,8	45	18	63	59	60	2	810.442.1	78,5
Pg 48	2"	47,8	53	20	77	71	74	2	810.448.1	132

Pg 90° fitting, male, nickel plated brass

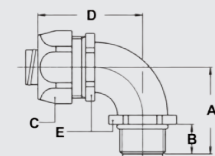

THREAD PG	SEALTITE SIZE (INCH)	MIN. INTERNAL BORE (MM)	DIMENSIONS IN MM					STANDARD PACKAGE	ARTICLE NUMBER	WEIGHT (KG/100)
			A	B	C	D	E			
Pg 11	5/16"	8,3	32	12	26	42	22	10	810.912.1*	9,3
Pg 13,5	5/16"	8,3	32	12	26	42	22	10	810.914.1*	9,3
Pg 11	3/8"	10,2	32	12	26	42	22	10	810.911.1	8,9
Pg 13,5	3/8"	10,2	32	12	26	42	22	10	810.913.1	8,9
Pg 16	1/2"	13,9	36	13	29	43	27	10	810.916.1	15,3
Pg 21	3/4"	18,5	43	15	35	48	33	5	810.921.1	21,6
Pg 29	1"	23,8	48	15	45	59	42	5	810.929.1	35,3
Pg 36	1.1/4"	31,8	57	16	54	68	51	2	810.936.1	62,5
Pg 42	1.1/2"	36,8	63	18	63	78	60	2	810.942.1	88,1
Pg 48	2"	47,8	74	20	77	96	74	2	810.948.1	141,9

\* Sizes 1/4" and 5/16" do not have UL / CSA approval.

## STANDARD FITTINGS, IP 67, NICKEL PLATED BRASS

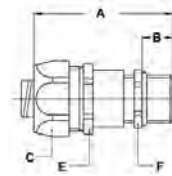

Pg cable-hose fitting, male, nickel plated brass



THREAD PG	SEALTITE SIZE (INCH)	CLAMPING RANGE (MM)	DIMENSIONS IN MM					STANDARD PACKAGE	ARTICLE NUMBER	WEIGHT (KG/100)
			A	B	C	E	F			
Pg 9	5/16"	4 - 8	55	10	26	24	17	10	810.709.1	8,2
Pg 9	3/8"	5 - 8	55	10	26	24	20	10	810.712.1	7,8
Pg 11	3/8"	5 - 10	55	10	26	24	20	10	810.711.1	9,5
Pg 13,5	1/2"	6 - 12	57	10	29	27	22	10	810.715.1	9,7
Pg 16	1/2"	10 - 13,9	60	10	29	27	24	10	810.716.1	11,7
Pg 21	3/4"	13 - 18	67	12	35	33	30	5	810.721.1	19,6
Pg 29	1"	18 - 23,8	80	12	45	43	40	5	810.729.1	35,4

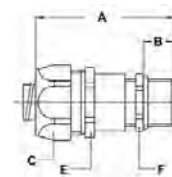

Pg, EMC cable-hose fitting, male, nickel plated brass



Sealtite fittings

THREAD PG	SEALTITE SIZE (INCH)	CLAMPING RANGE (MM)	DIMENSIONS IN MM					STANDARD PACKAGE	ARTICLE NUMBER	WEIGHT (KG/100)
			A	B	C	E	F			
Pg 9	5/16"	4 - 8	55	10	26	24	17	10	810.609.1	8,2
Pg 9	3/8"	5 - 8	55	10	26	24	20	10	810.612.1	7,8
Pg 11	3/8"	5 - 10	55	10	26	24	20	10	810.611.1	9,5
Pg 13,5	1/2"	6 - 12	57	10	29	27	22	10	810.615.1	9,7
Pg 16	1/2"	10 - 13,9	60	10	29	27	24	10	810.616.1	11,7
Pg 21	3/4"	13 - 18	67	12	35	33	30	5	810.621.1	19,6
Pg 29	1"	18 - 23,8	80	12	45	43	40	5	810.629.1	35,4

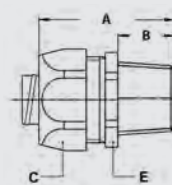

NPT straight fitting, male, nickel plated brass



THREAD NPT	SEALTITE SIZE (INCH)	MIN. INTERNAL BORE (MM)	DIMENSIONS IN MM					STANDARD PACKAGE	ARTICLE NUMBER	WEIGHT (KG/100)
			A	B	C	D	E			
1/2" NPT	5/16"	8,3	35	12	26	-	24	10	814.011.1*	6
1/2" NPT	3/8"	10,2	35	12	26	-	24	10	814.012.1	5,6
1/2" NPT	1/2"	13,9	37	13	29	-	27	10	814.016.1	6,2
3/4" NPT	3/4"	18,5	40	15	35	-	33	5	814.020.1	8,9
1" NPT	1"	23,8	46	15	45	-	43	5	814.026.1	25
1.1/4" NPT	1.1/4"	31,8	52	16	54	-	52	2	814.035.1	40
1.1/2" NPT	1.1/2"	36,8	56	18	63	-	60	2	814.040.1	43,8
2" NPT	2"	47,8	66	20	77	-	74	2	814.050.1	73,5

\* Sizes 1/4" and 5/16" do not have UL / CSA approval.

## STANDARD FITTINGS, IP 67, NICKEL PLATED BRASS

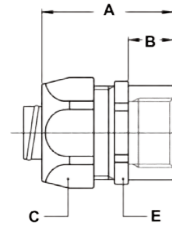

NPT straight fitting, female, nickel plated brass



THREAD NPT	SEALTITE SIZE (INCH)	MIN. INTERNAL BORE (MM)	DIMENSIONS IN MM					STANDARD PACKAGE	ARTICLE NUMBER	WEIGHT (KG/100)
			A	B	C	D	E			
1/2" NPT	5/16"	8,3	37	13	26	-	24	10	814.311.1*	5,7
1/2" NPT	3/8"	10,2	37	13	26	-	24	10	814.312.1	5,3
1/2" NPT	1/2"	13,9	37	13	29	-	27	10	814.316.1	6,2
3/4" NPT	3/4"	18,5	40	15	35	-	33	5	814.320.1	9
1" NPT	1"	23,8	46	15	45	-	43	5	814.326.1	20,7
1.1/4" NPT	1.1/4"	31,8	52	16	54	-	52	2	814.335.1	29,3
1.1/2" NPT	1.1/2"	36,8	56	18	63	-	60	2	814.340.1	43,8
2" NPT	2"	47,8	66	20	77	-	74	2	814.350.1	73,3

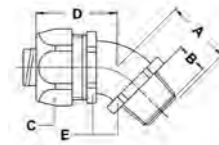

NPT 45° fitting, male, nickel plated brass



THREAD NPT	SEALTITE SIZE (INCH)	MIN. INTERNAL BORE (MM)	DIMENSIONS IN MM					STANDARD PACKAGE	ARTICLE NUMBER	WEIGHT (KG/100)
			A	B	C	D	E			
1/2" NPT	5/16"	8,3	23	12	26	33	22	10	814.411.1*	8,3
1/2" NPT	3/8"	10,2	23	12	26	33	22	10	814.412.1	7,9
1/2" NPT	1/2"	13,9	25	13	29	33	27	10	814.416.1	10,7
3/4" NPT	3/4"	18,5	30	15	35	36	33	5	814.420.1	15,7
1" NPT	1"	23,8	34	15	45	46	42	5	814.426.1	31,8
1.1/4" NPT	1.1/4"	31,8	39	16	54	54	51	2	814.435.1	54,2
1.1/2" NPT	1.1/2"	36,8	45	18	63	59	60	2	814.440.1	78,5
2" NPT	2"	47,8	53	20	77	71	74	2	814.450.1	132

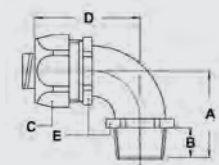

NPT 90° fitting, male, nickel plated brass



THREAD NPT	SEALTITE SIZE (INCH)	MIN. INTERNAL BORE (MM)	DIMENSIONS IN MM					STANDARD PACKAGE	ARTICLE NUMBER	WEIGHT (KG/100)
			A	B	C	D	E			
1/2" NPT	5/16"	8,3	32	12	26	42	22	10	814.911.1*	13,7
1/2" NPT	3/8"	10,2	32	12	26	42	22	10	814.912.1	13,3
1/2" NPT	1/2"	13,9	36	13	29	43	27	10	814.916.1	14,6
3/4" NPT	3/4"	18,5	43	15	35	48	33	5	814.920.1	22
1" NPT	1"	23,8	48	15	45	59	42	5	814.926.1	31,7
1.1/4" NPT	1.1/4"	31,8	57	16	54	68	51	2	814.935.1	62,5
1.1/2" NPT	1.1/2"	36,8	63	18	63	78	60	2	814.940.1	89,1
2" NPT	2"	47,8	74	20	77	96	74	2	814.950.1	141,9

## STANDARD FITTINGS, IP 67, NICKEL PLATED BRASS

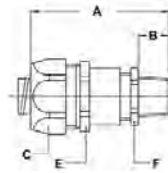

NPT cable-hose fitting, male, nickel plated brass



THREAD NPT	SEALTITE SIZE (INCH)	CLAMPING RANGE (MM)	DIMENSIONS IN MM					STANDARD PACKAGE	ARTICLE NUMBER	WEIGHT (KG/100)
			A	B	C	E	F			
3/8" NPT	5/16"	4 - 8	60	15	26	24	17	10	814.709.1	8,2
3/8" NPT	3/8"	4 - 8	60	15	26	24	17	10	814.710.1	7,8
1/2" NPT	3/8"	6 - 10,2	57	13	26	24	22	10	814.712.1	11,7
1/2" NPT	1/2"	6 - 12	59	13	29	27	22	10	814.715.1	11,7
3/4" NPT	3/4"	13 - 18	68	13	35	33	30	5	814.721.1	19,6



Grounding ferrule, zinc plated steel



Sealtite fittings

THREAD	SEALTITE SIZE (INCH)	MIN. INTERNAL BORE (MM)	DIMENSIONS IN MM					STANDARD PACKAGE	ARTICLE NUMBER	WEIGHT (KG/100)
			A	B	C	D	E			
-	3/8"	10,2	-	-	-	-	-	10	815.011.0	0,4
-	1/2"	13,9	-	-	-	-	-	10	815.016.0	0,6
-	3/4"	18,5	-	-	-	-	-	5	815.021.0	0,8
-	1"	23,8	-	-	-	-	-	5	815.029.0	1,4



Grounding ferrule, nickel plated brass



THREAD	SEALTITE SIZE (INCH)	MIN. INTERNAL BORE (MM)	DIMENSIONS IN MM					STANDARD PACKAGE	ARTICLE NUMBER	WEIGHT (KG/100)
			A	B	C	D	E			
-	1/4"	5,2	-	-	-	-	-	10	815.006.0	0,4
-	5/16"	8,3	-	-	-	-	-	10	815.010.0	0,8
-	3/8"	10,2	-	-	-	-	-	10	815.011.3	0,6
-	1/2"	13,9	-	-	-	-	-	10	815.016.3	0,8
-	3/4"	18,5	-	-	-	-	-	5	815.021.3	1,4
-	1"	23,8	-	-	-	-	-	5	815.029.3	2,8
-	1.1/4"	31,8	-	-	-	-	-	2	815.036.3	6
-	1.1/2"	36,8	-	-	-	-	-	2	815.042.3	6,8
-	2"	47,8	-	-	-	-	-	2	815.048.3	8,8



# Compact fittings, IP 66 / IP 67, stainless steel AISI-304



## ANACONDA COMPACT FITTINGS, UL & CSA, STAINLESS STEEL AISI-304, FOR ANACONDA SEALTITE

Anaconda compact stainless steel AISI-304 fittings can be used with all types of Anaconda Sealtite conduit with the exception of type CNP. These fittings contain less material, are shorter in length and lighter in weight than the Anaconda standard range. They are ideal for use in standard applications and installations where space is limited as well as environments where corrosion protection is required. The range is IP 66 / IP 67 rated and UL & CSA approved.

### Material & Construction:

**Construction:** Stainless steel AISI-304, consisting of 4 parts (counter nut, clamping ring, ferrule and body).

**Material:** Counter nut, body and ferrule are stainless steel AISI-304. Clamping ring is made from PA6. The O-rings are from NBR rubber (black for ISO).

**Special approvals:** UL-514B and CSA C 22.2 (combined UL / CSA [CUL] file # E 234207).

Suitable for use in hazardous environments according to NEC:

- Article 501.10 (B) (2). Class I, Division 2.
- Article 502.10 (A) (2) and (B) (2). Class II, Division 1 and 2.
- Article 503.10 (A) (3) and (B). Class III, Division 1 and 2.

**Temperature:** -45 °C till +105 °C continuous.

**Protection class:** IP 66, IP 67, NEMA 4X.

**Colour:** Metal coloured.



ISO straight fitting, compact, stainless steel AISI-304

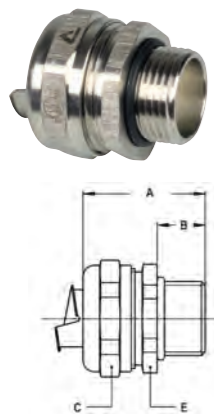

THREAD ISO	SEALTITE SIZE (INCH)	MIN. INTERNAL BORE (MM)	DIMENSIONS IN MM					STANDARD PACKAGE	ARTICLE NUMBER	WEIGHT (KG/100)
			A	B	C	D	E			
M16 x 1,5	5/16"	8,3	31	10	26	-	24	10	712.015.9*	4,3
M20 x 1,5	5/16"	8,3	31	10	26	-	24	10	712.014.9*	4,4
M16 x 1,5	3/8"	11	31	10	26	-	24	10	712.016.9	3,9
M20 x 1,5	3/8"	11	31	10	26	-	24	10	712.017.9	4
M20 x 1,5	1/2"	14,5	32	10	29	-	27	10	712.020.9	4,4
M25 x 1,5	3/4"	19,4	33	10	35	-	33	5	712.025.9	6,6
M32 x 1,5	1"	24,7	36	12	45	-	42	5	712.032.9	11,7
M40 x 1,5	1.1/4"	33,3	40	13	53	-	50	2	712.040.9	16
M50 x 1,5	1.1/2"	38	46	14	62	-	58	2	712.050.9	25,3
M63 x 1,5	2"	49	52	16	76	-	72	2	712.063.9	38,6

ISO 90° fitting, compact, male, stainless steel AISI-304

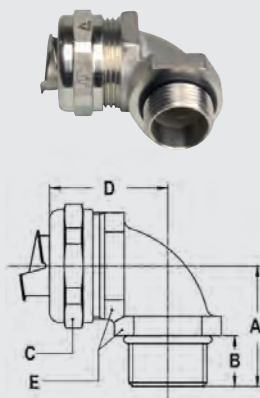

THREAD ISO	SEALTITE SIZE (INCH)	MIN. INTERNAL BORE (MM)	DIMENSIONS IN MM					STANDARD PACKAGE	ARTICLE NUMBER	WEIGHT (KG/100)
			A	B	C	D	E			
M16 x 1,5	5/16"	8,3	26	10	26	31	22	10	712.915.9*	7
M20 x 1,5	5/16"	8,3	26	10	26	32	24	10	712.914.9*	8,3
M16 x 1,5	3/8"	11	26	10	26	31	22	10	712.916.9	6,6
M20 x 1,5	3/8"	11	26	10	26	32	24	10	712.917.9	7,9
M20 x 1,5	1/2"	14,5	28	10	29	34	27	10	712.920.9	9,2
M25 x 1,5	3/4"	19,4	32	10	35	40	33	5	712.925.9	16,2
M32 x 1,5	1"	24,7	40	12	45	49	42	5	712.932.9	27,8
M40 x 1,5	1.1/4"	33,3	46	13	53	53	52	2	712.940.9	40,1
M50 x 1,5	1.1/2"	38	52	14	62	57	60	2	712.950.9	57,5
M63 x 1,5	2"	49	62	16	76	68	72	2	712.963.9	90,6

\* Sizes 1/4", 5/16", 2.1/2" and 3" do not have UL / CSA approval.

## COMPACT FITTINGS, IP 66 / IP 67, STAINLESS STEEL AISI-304

NPT straight fitting, compact, male, stainless steel AISI-304

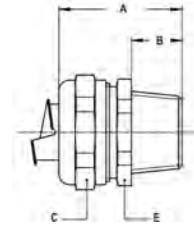

THREAD NPT	SEALTITE SIZE (INCH)	MIN. INTERNAL BORE (MM)	DIMENSIONS IN MM					STANDARD PACKAGE	ARTICLE NUMBER	WEIGHT (KG/100)
			A	B	C	D	E			
NPT 1/2"	5/16"	8,3	35	14	26	-	24	10	714.011.9*	4,8
NPT 1/2"	3/8"	11	35	14	26	-	24	10	714.012.9	4,4
NPT 1/2"	1/2"	14,5	36	14	29	-	27	10	714.016.9	5
NPT 3/4"	3/4"	19,4	37	14	35	-	33	5	714.020.9	7
NPT 1"	1"	24,7	40	16	45	-	42	5	714.026.9	12,6
NPT 1.1/4"	1.1/4"	33,3	43	16	53	-	50	2	714.035.9	16,8
NPT 1.1/2"	1.1/2"	38	50	18	62	-	58	2	714.040.9	25,8
NPT 2"	2"	49	56	20	76	-	72	2	714.050.9	41,2
NPT 2.1/2"	2.1/2"	60,7	67	25	90	-	85	1	714.063.91*	83,6
NPT 3"	3"	75,5	73	27	108	-	102	1	714.075.91*	113,9

NPT 45° fitting, compact, male, stainless steel AISI-304

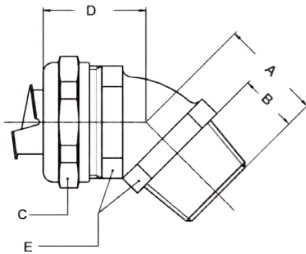

THREAD NPT	SEALTITE SIZE (INCH)	MIN. INTERNAL BORE (MM)	DIMENSIONS IN MM					STANDARD PACKAGE	ARTICLE NUMBER	WEIGHT (KG/100)
			A	B	C	D	E			
NPT 1/2"	5/16"	8,3	24	14	26	28	24	10	714.411.9*	8,1
NPT 1/2"	3/8"	11	24	14	26	28	24	10	714.412.9	7,7
NPT 1/2"	1/2"	14,5	25	14	29	30	27	10	714.416.9	8,8
NPT 3/4"	3/4"	19,4	27	14	35	33	33	5	714.420.9	14,5
NPT 1"	1"	24,7	32	16	45	38	42	5	714.426.9	24
NPT 1.1/4"	1.1/4"	33,3	36	16	53	39	52	2	714.435.9	35,5
NPT 1.1/2"	1.1/2"	38	39	18	62	46	60	2	714.440.9	51
NPT 2"	2"	49	44	20	76	53	72	2	714.450.9	85,5
NPT 3"	3"	75,5	61	27	108	74	102	1	714.475.9*	220

Sealtite fittings

NPT 90° fitting, compact, male, stainless steel AISI-304

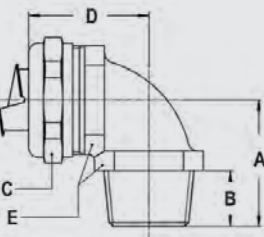

THREAD NPT	SEALTITE SIZE (INCH)	MIN. INTERNAL BORE (MM)	DIMENSIONS IN MM					STANDARD PACKAGE	ARTICLE NUMBER	WEIGHT (KG/100)
			A	B	C	D	E			
NPT 1/2"	5/16"	8,3	30	14	26	32	24	10	714.911.9*	8,6
NPT 1/2"	3/8"	11	30	14	26	32	24	10	714.912.9	8,2
NPT 1/2"	1/2"	14,5	32	14	29	34	27	10	714.916.9	9,6
NPT 3/4"	3/4"	19,4	36	14	35	40	33	5	714.920.9	16,7
NPT 1"	1"	24,7	44	16	45	49	42	5	714.926.9	28,3
NPT 1.1/4"	1.1/4"	33,3	49	16	53	53	52	2	714.935.9	41,4
NPT 1.1/2"	1.1/2"	38	56	18	62	57	60	2	714.940.9	57,3
NPT 2"	2"	49	66	20	76	68	72	2	714.950.9	90,8
NPT 3"	3"	75,5	92	27	108	97	102	1	714.975.9*	289

## COMPACT FITTINGS, IP 66 / IP 67, STAINLESS STEEL AISI-304

NPT straight fitting, compact, male, stainless steel AISI-304, including washer and locknut

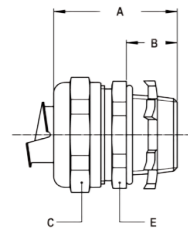

THREAD NPT	SEALTITE SIZE (INCH)	MIN. INTERNAL BORE (MM)	DIMENSIONS IN MM					STANDARD PACKAGE	ARTICLE NUMBER	WEIGHT (KG/100)
			A	B	C	D	E			
NPT 1/2"	5/16"	8,3	35	14	26	-	24	10	714.011.92*	5,3
NPT 1/2"	3/8"	11	35	14	26	-	24	10	714.012.92	4,9
NPT 1/2"	1/2"	14,5	36	14	29	-	27	10	714.016.92	5,5
NPT 3/4"	3/4"	19,4	37	14	35	-	33	5	714.020.92	7,8
NPT 1"	1"	24,7	40	16	45	-	42	5	714.026.92	13,9
NPT 1.1/4"	1.1/4"	33,3	43	16	53	-	50	2	714.035.92	18,6
NPT 1.1/2"	1.1/2"	38	50	18	62	-	58	2	714.040.92	28
NPT 2"	2"	49	56	20	76	-	72	2	714.050.92	45
NPT 2.1/2"	2.1/2"	60,7	67	25	90	-	85	1	714.063.92*	87,1
NPT 3"	3"	75,5	73	27	108	-	102	1	714.075.92*	119,5

NPT 45° fitting, compact, male, stainless steel AISI-304, including washer and locknut

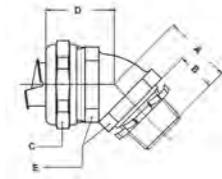

THREAD NPT	SEALTITE SIZE (INCH)	MIN. INTERNAL BORE (MM)	DIMENSIONS IN MM					STANDARD PACKAGE	ARTICLE NUMBER	WEIGHT (KG/100)
			A	B	C	D	E			
NPT 1/2"	5/16"	8,3	24	14	26	28	24	10	714.411.92*	8,6
NPT 1/2"	3/8"	11	24	14	26	28	24	10	714.412.92	8,2
NPT 1/2"	1/2"	14,5	25	14	29	30	27	10	714.416.92	9,3
NPT 3/4"	3/4"	19,4	27	14	35	33	33	5	714.420.92	15,3
NPT 1"	1"	24,7	32	16	45	38	42	5	714.426.92	25,3
NPT 1.1/4"	1.1/4"	33,3	36	16	53	39	52	2	714.435.92	37,3
NPT 1.1/2"	1.1/2"	38	39	18	62	46	60	2	714.440.92	53,2
NPT 2"	2"	49	44	20	76	53	72	2	714.450.92	88,3
NPT 3"	3"	75,5	61	27	108	74	102	1	714.475.92*	225,6

NPT 90° fitting, compact, male, stainless steel AISI-304, including washer and locknut

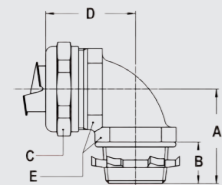

THREAD NPT	SEALTITE SIZE (INCH)	MIN. INTERNAL BORE (MM)	DIMENSIONS IN MM					STANDARD PACKAGE	ARTICLE NUMBER	WEIGHT (KG/100)
			A	B	C	D	E			
NPT 1/2"	5/16"	8,3	30	14	26	32	24	10	714.911.92*	9,1
NPT 1/2"	3/8"	11	30	14	26	32	24	10	714.912.92	8,7
NPT 1/2"	1/2"	14,5	32	14	29	34	27	10	714.916.92	10,1
NPT 3/4"	3/4"	19,4	36	14	35	40	33	5	714.920.92	17,5
NPT 1"	1"	24,7	44	16	45	49	42	5	714.926.92	29,6
NPT 1.1/4"	1.1/4"	33,3	49	16	53	53	52	2	714.935.92	43,2
NPT 1.1/2"	1.1/2"	38	56	18	62	57	60	2	714.940.92	59,5
NPT 2"	2"	49	66	20	76	68	72	2	714.950.92	93,6
NPT 3"	3"	75,5	92	27	108	97	102	1	714.975.92*	294,6

\* Sizes 1/4", 5/16", 2.1/2" and 3" do not have UL / CSA approval.

## COMPACT FITTINGS, IP 66 / IP 67, STAINLESS STEEL AISI-304



Grounding ferrule, stainless steel AISI-304



THREAD	SEALTITE SIZE (INCH)	MIN. INTERNAL BORE (MM)	DIMENSIONS IN MM					STANDARD PACKAGE	ARTICLE NUMBER	WEIGHT (KG/100)
			A	B	C	D	E			
-	3/8"	11	-	-	-	-	-	50	815.011.5	0,4
-	1/2"	14,5	-	-	-	-	-	50	815.016.5	0,5
-	3/4"	19,4	-	-	-	-	-	25	815.021.5	0,7
-	1"	24,7	-	-	-	-	-	25	815.029.5	1,1
-	1.1/4"	33,3	-	-	-	-	-	10	815.036.5	1,5
-	1.1/2"	38	-	-	-	-	-	10	815.042.5	2,1
-	2"	49	-	-	-	-	-	10	815.048.5	3,2
-	2.1/2"	60,7	-	-	-	-	-	5	815.063.5	4,3
-	3"	75,5	-	-	-	-	-	5	815.075.5	5,9



ISO lock nuts, stainless steel AISI-304



THREAD	SEALTITE SIZE (INCH)	MIN. INTERNAL BORE (MM)	DIMENSIONS IN MM					STANDARD PACKAGE	ARTICLE NUMBER	WEIGHT (KG/100)
			A	B	C	D	E			
M16 x 1,5	-	-	3,2	-	20	-	-	50	880.116.9	0,5
M20 x 1,5	-	-	3,6	-	24	-	-	50	880.120.9	0,7
M25 x 1,5	-	-	3,6	-	29	-	-	25	880.125.9	1,1
M32 x 1,5	-	-	4,6	-	35	-	-	25	880.132.9	2,4
M40 x 1,5	-	-	5	-	46	-	-	5	880.140.9	3,6
M50 x 1,5	-	-	5	-	60	-	-	5	880.150.9	5,4
M63 x 1,5	-	-	6	-	70	-	-	5	880.163.9	6,2

Sealtite fittings



NPT "tiger grip" locknut, stainless steel AISI-304



THREAD	SEALTITE SIZE (INCH)	MIN. INTERNAL BORE (MM)	DIMENSIONS IN MM					STANDARD PACKAGE	ARTICLE NUMBER	WEIGHT (KG/100)
			A	B	C	D	E			
NPT 1/2"	-	-	-	-	-	-	-	100	880.316.9	0,5
NPT 3/4"	-	-	-	-	-	-	-	50	880.320.9	0,8
NPT 1"	-	-	-	-	-	-	-	50	880.326.9	1,3
NPT 1.1/4"	-	-	-	-	-	-	-	20	880.335.9	1,8
NPT 1.1/2"	-	-	-	-	-	-	-	20	880.340.9	2,2
NPT 2"	-	-	-	-	-	-	-	20	880.350.9	2,8
NPT 2.1/2"	-	-	-	-	-	-	-	5	880.363.9	3,5
NPT 3"	-	-	-	-	-	-	-	5	880.375.9	5,6

NBR rubber seal for NPT



THREAD	SEALTITE SIZE (INCH)	MIN. INTERNAL BORE (MM)	DIMENSIONS IN MM					STANDARD PACKAGE	ARTICLE NUMBER	WEIGHT (KG/100)
			A	B	C	D	E			
NPT 1/2"	1/2"	-	-	-	-	-	-	50	815.616.0	0,03
NPT 3/4"	3/4"	-	-	-	-	-	-	25	815.620.0	0,05
NPT 1"	1"	-	-	-	-	-	-	25	815.626.0	0,11
NPT 1.1/4"	1.1/4"	-	-	-	-	-	-	10	815.635.0	0,15
NPT 1.1/2"	1.1/2"	-	-	-	-	-	-	10	815.640.0	0,19
NPT 2"	2"	-	-	-	-	-	-	10	815.650.0	0,33
NPT 2.1/2"	2.1/2"	-	-	-	-	-	-	10	815.663.0	0,45
NPT 3"	3"	-	-	-	-	-	-	10	815.675.0	0,6

# Standard fittings, IP 67, stainless steel AISI-304



## ANACONDA STAINLESS STEEL AISI-304 FITTINGS FOR ANACONDA SEALTITE

The stainless steel AISI-304 Anaconda fittings can be used with all types of Anaconda Sealtite (except CNP). These fittings offer excellent corrosion resistance and are mostly used in the off-shore, chemical and food industry. Because of the UL & CSA approvals the fittings are also suitable for export projects outside Europe.

### Material & Construction:

**Construction:** Stainless steel AISI-304 fitting, consisting of 4 parts (counter nut, clamping ring, ferrule and body).

**Material:** Counter nut and body are stainless steel AISI-304 and the ferrule is from nickel plated brass. Clamping ring and insert are from PA6 (red for ISO metric, blue for Pg and white for NPT).

**Special approvals:** UL-514B and CSA C 22.2 (combined UL / CSA file # E 234207).

Suitable for use in hazardous environments according to NEC:

- Article 501.10 (B) (2).  
Class I, Division 2.
- Article 502.10 (A) (2) and (B) (2).  
Class II, Division 1 and 2.
- Article 503.10 (A) (3) and (B).  
Class III, Division 1 and 2.

**Temperature:** -45 °C till +105 °C continuous.  
(cable-hose fittings are -40 °C till +100 °C).

**Protection class:** IP 67 (dust-proof, water-tight),  
with cable-hose fittings an IP 68 rate on the  
switchbox can be obtained.

**Colour:** Metal coloured.

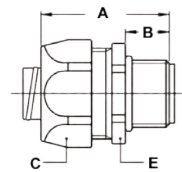

ISO straight fitting, male, stainless steel AISI-304



THREAD ISO	SEALTITE SIZE (INCH)	MIN. INTERNAL BORE (MM)	DIMENSIONS IN MM					STANDARD PACKAGE	ARTICLE NUMBER	WEIGHT (KG/100)
			A	B	C	D	E			
M16 x 1,5	5/16"	8,3	35	12	27	-	24	10	812.015.9*	5,2
M20 x 1,5	5/16"	8,3	36	13	27	-	24	10	812.014.9*	5,5
M16 x 1,5	3/8"	10,2	35	12	27	-	24	10	812.016.9	4,8
M20 x 1,5	3/8"	10,2	36	13	27	-	24	10	812.017.9	5,1
M20 x 1,5	1/2"	13,9	37	13	30	-	27	10	812.020.9	5,9
M25 x 1,5	3/4"	18,5	40	15	36	-	36	5	812.025.9	7,9
M32 x 1,5	1"	23,8	46	15	46	-	46	5	812.032.9	17,5
M40 x 1,5	1.1/4"	31,8	52	16	54	-	52	2	812.040.9	27,9

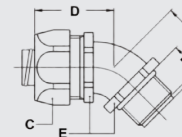

ISO 45° fitting, male, stainless steel AISI-304



THREAD ISO	SEALTITE SIZE (INCH)	MIN. INTERNAL BORE (MM)	DIMENSIONS IN MM					STANDARD PACKAGE	ARTICLE NUMBER	WEIGHT (KG/100)
			A	B	C	D	E			
M16 x 1,5	5/16"	8,3	23	12	27	33	22	10	812.415.9*	7,7
M20 x 1,5	5/16"	8,3	24	13	27	33	22	10	812.414.9*	7,8
M16 x 1,5	3/8"	10,2	23	12	27	33	22	10	812.416.9	7,3
M20 x 1,5	3/8"	10,2	24	13	27	33	22	10	812.417.9	7,4
M20 x 1,5	1/2"	13,9	25	13	30	33	27	10	812.420.9	10,5
M25 x 1,5	3/4"	18,5	30	15	36	36	33	5	812.425.9	13,6

\* Sizes 1/4" and 5/16" do not have UL / CSA approval.



## STANDARD FITTINGS, IP 67, STAINLESS STEEL AISI-304

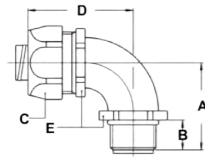

ISO 90° fitting, male, stainless steel AISI-304



THREAD ISO	SEALTITE SIZE (INCH)	MIN. INTERNAL BORE (MM)	DIMENSIONS IN MM					STANDARD PACKAGE	ARTICLE NUMBER	WEIGHT (KG/100)
			A	B	C	D	E			
M16 x 1,5	5/16"	8,3	32	12	27	42	22	10	812.915.9*	8,6
M20 x 1,5	5/16"	8,3	33	13	27	42	22	10	812.914.9*	8,8
M16 x 1,5	3/8"	10,2	32	12	27	42	22	10	812.916.9	8,2
M20 x 1,5	3/8"	10,2	33	13	27	42	22	10	812.917.9	8,4
M20 x 1,5	1/2"	13,9	36	13	30	43	27	10	812.920.9	12,6
M25 x 1,5	3/4"	18,5	43	15	36	48	33	5	812.925.9	19,2

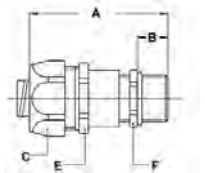

ISO cable-hose fitting, male, stainless steel AISI-304



Sealtite fittings

THREAD ISO	SEALTITE SIZE (INCH)	CLAMPING RANGE (MM)	DIMENSIONS IN MM					STANDARD PACKAGE	ARTICLE NUMBER	WEIGHT (KG/100)
			A	B	C	E	F			
M16 x 1,5	5/16"	4 - 8	57	12	27	24	18	10	812.715.9	8,2
M16 x 1,5	3/8"	4 - 8	57	12	27	24	18	10	812.716.9	7,8
M20 x 1,5	3/8"	6 - 10,2	57	12	27	24	22	10	812.717.9	9,5
M20 x 1,5	1/2"	6 - 12	59	12	30	27	22	10	812.720.9	9,7

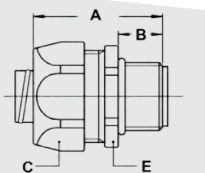

Pg straight fitting, male, stainless steel AISI-304



THREAD PG	SEALTITE SIZE (INCH)	MIN. INTERNAL BORE (MM)	DIMENSIONS IN MM					STANDARD PACKAGE	ARTICLE NUMBER	WEIGHT (KG/100)
			A	B	C	D	E			
Pg 11	5/16"	8,3	35	12	27	-	24	10	810.012.9*	6
Pg 13,5	5/16"	8,3	35	12	27	-	24	10	810.014.9*	6
Pg 11	3/8"	10,2	35	12	27	-	24	10	810.011.9	5,6
Pg 13,5	3/8"	10,2	35	12	27	-	24	10	810.013.9	5,6
Pg 16	1/2"	13,9	37	13	30	-	27	10	810.016.9	6,3
Pg 21	3/4"	18,5	40	15	36	-	36	5	810.021.9	8,4
Pg 29	1"	23,8	46	15	46	-	46	5	810.029.9	25
Pg 36	1.1/4"	31,8	52	16	54	-	52	2	810.036.9	34,6
Pg 42	1.1/2"	36,8	56	18	63	-	60	2	810.042.9	47,2
Pg 48	2"	47,8	66	20	77	-	74	2	810.048.9	72

\* Sizes 1/4" and 5/16" do not have UL / CSA approval.

## STANDARD FITTINGS, IP 67, STAINLESS STEEL AISI-304

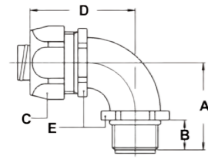

Pg 90° fitting, male, stainless steel AISI-304



THREAD PG	SEALTITE SIZE (INCH)	MIN. INTERNAL BORE (MM)	DIMENSIONS IN MM					STANDARD PACKAGE	ARTICLE NUMBER	WEIGHT (KG/100)
			A	B	C	D	E			
Pg 11	5/16"	8,3	32	12	27	42	22	10	810.912.9*	9,3
Pg 11	3/8"	10,2	32	12	27	42	22	10	810.911.9	8,9
Pg 16	1/2"	13,9	36	13	30	43	27	10	810.916.9	15,3
Pg 21	3/4"	18,5	43	15	36	48	33	5	810.921.9	21,6
Pg 29	1"	23,8	48	15	46	50	42	5	810.929.9	35,3

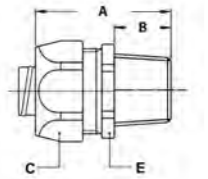

NPT straight fitting, male, stainless steel AISI-304



THREAD NPT	SEALTITE SIZE (INCH)	MIN. INTERNAL BORE (MM)	DIMENSIONS IN MM					STANDARD PACKAGE	ARTICLE NUMBER	WEIGHT (KG/100)
			A	B	C	D	E			
1/2" NPT	5/16"	8,3	37	13	27	-	24	10	814.011.9*	6
1/2" NPT	3/8"	10,2	37	13	27	-	24	10	814.012.9	5,6
1/2" NPT	1/2"	13,9	37	13	30	-	27	10	814.016.9	6,2
3/4" NPT	3/4"	18,5	40	15	36	-	36	5	814.020.9	8,9
1" NPT	1"	23,8	46	15	46	-	46	5	814.026.9	25

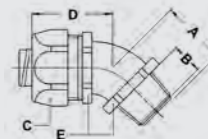

NPT 45° fitting, male, stainless steel AISI-304



THREAD NPT	SEALTITE SIZE (INCH)	MIN. INTERNAL BORE (MM)	DIMENSIONS IN MM					STANDARD PACKAGE	ARTICLE NUMBER	WEIGHT (KG/100)
			A	B	C	D	E			
1/2" NPT	5/16"	8,3	25	13	27	33	22	10	814.411.9*	8,3
1/2" NPT	3/8"	10,2	25	13	27	33	22	10	814.412.9	7,9
1/2" NPT	1/2"	13,9	25	13	30	33	27	10	814.416.9	10,7
3/4" NPT	3/4"	18,5	30	15	36	36	33	5	814.420.9	15,7

\* Sizes 1/4" and 5/16" do not have UL / CSA approval.

## STANDARD FITTINGS, IP 67, STAINLESS STEEL AISI-304

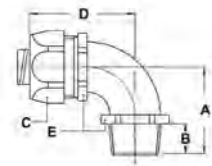

NPT 90° fitting, male, stainless steel AISI-304



THREAD NPT	SEALTITE SIZE (INCH)	MIN. INTERNAL BORE (MM)	DIMENSIONS IN MM					STANDARD PACKAGE	ARTICLE NUMBER	WEIGHT (KG/100)
			A	B	C	D	E			
1/2" NPT	5/16"	8,3	36	13	27	43	22	10	814.911.9*	13,7
1/2" NPT	3/8"	10,2	36	13	27	43	22	10	814.912.9	13,3
1/2" NPT	1/2"	13,9	36	13	30	43	27	10	814.916.9	14,6
3/4" NPT	3/4"	18,5	43	15	36	48	33	5	814.920.9	22
1" NPT	1"	23,8	48	15	46	59	42	5	814.926.9	31,7

\* Size 5/16" does not have UL / CSA approval.



ISO lock nuts, stainless steel AISI-304

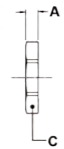

THREAD	SEALTITE SIZE (INCH)	MIN. INTERNAL BORE (MM)	DIMENSIONS IN MM					STANDARD PACKAGE	ARTICLE NUMBER	WEIGHT (KG/100)
			A	B	C	D	E			
M16 x 1,5	-	-	3,2	-	20	-	-	50	880.116.9	0,5
M20 x 1,5	-	-	3,6	-	24	-	-	50	880.120.9	0,7
M25 x 1,5	-	-	3,6	-	29	-	-	25	880.125.9	1,1
M32 x 1,5	-	-	4,6	-	35	-	-	25	880.132.9	2,4
M40 x 1,5	-	-	5	-	46	-	-	5	880.140.9	3,6
M50 x 1,5	-	-	5	-	60	-	-	5	880.150.9	5,4
M63 x 1,5	-	-	6	-	70	-	-	5	880.163.9	6,2

Sealtite fittings



NPT lock nuts, stainless steel AISI-304



THREAD	SEALTITE SIZE (INCH)	MIN. INTERNAL BORE (MM)	DIMENSIONS IN MM					STANDARD PACKAGE	ARTICLE NUMBER	WEIGHT (KG/100)
			A	B	C	D	E			
NPT 1/2"	-	-	4	-	27	-	-	50	880.216.9	1,1
NPT 3/4"	-	-	4,5	-	32	-	-	25	880.220.9	1,4
NPT 1"	-	-	6	-	38	-	-	25	880.226.9	2,1
NPT 1.1/4"	-	-	6,5	-	48	-	-	5	880.235.9	3,5
NPT 1.1/2"	-	-	7	-	55	-	-	5	880.240.9	5
NPT 2"	-	-	7,5	-	70	-	-	5	880.250.9	8,8



NPT "tiger grip" locknut, stainless steel AISI-304



THREAD	SEALTITE SIZE (INCH)	MIN. INTERNAL BORE (MM)	DIMENSIONS IN MM					STANDARD PACKAGE	ARTICLE NUMBER	WEIGHT (KG/100)
			A	B	C	D	E			
NPT 1/2"	-	-	-	-	-	-	-	100	880.316.9	0,5
NPT 3/4"	-	-	-	-	-	-	-	50	880.320.9	0,8
NPT 1"	-	-	-	-	-	-	-	50	880.326.9	1,3
NPT 1.1/4"	-	-	-	-	-	-	-	20	880.335.9	1,8
NPT 1.1/2"	-	-	-	-	-	-	-	20	880.340.9	2,2
NPT 2"	-	-	-	-	-	-	-	20	880.350.9	2,8

# Compact fittings, IP 66 / IP 67, stainless steel AISI-316

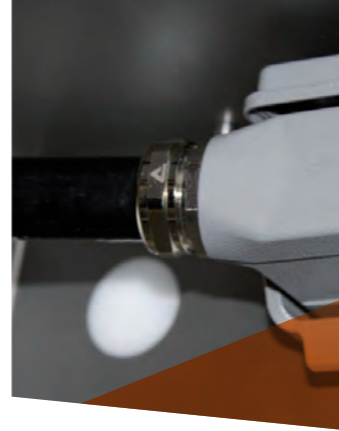

## ANACONDA COMPACT FITTINGS, UL & CSA, STAINLESS STEEL AISI-316, FOR ANACONDA SEALTITE

The compact stainless steel AISI-316 fittings can be used with all types of Anaconda Sealrite (except CNP). This Anaconda fitting is a universal fitting with shorter design and lower weight. All ferrules are flanged versions for a better fit. Because the fittings are made from stainless steel AISI-316 they offer superior corrosion protection in combination with a nice appearance. The compact fittings AISI-316 have UL & CSA approval.

### Material & Construction:

**Construction:** Stainless steel AISI-316, consisting of 4 parts (counter nut, clamping ring, ferrule and body).

**Material:** Counter nut and body are stainless steel AISI-316 whereas the ferrule is stainless steel AISI-304. Clamping ring is made from PA6. The O-rings are from NBR rubber.

**Special approvals:** UL-514B and CSA C 22.2 (combined UL / CSA [CUL] file # E 234207).

Suitable for use in hazardous environments according NEC.

- Article 501.10 (B) (2).  
Class I, Division 2.
- Article 502.10 (A) (2) and (B) (2).  
Class II, Division 1 and 2.
- Article 503.10 (A) (3) and (B) Class III, Division 1 and 2.

**Temperature:** -45 °C till +105 °C continuous.

**Protection class:** IP 66 / IP 67, Nema 4X.

**Colour:** Metal coloured.



ISO straight fitting, compact, stainless steel AISI-316

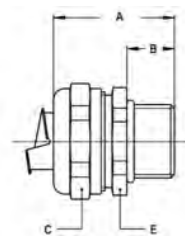

THREAD ISO	SEALTITE SIZE (INCH)	MIN. INTERNAL BORE (MM)	DIMENSIONS IN MM					STANDARD PACKAGE	ARTICLE NUMBER	WEIGHT (KG/100)
			A	B	C	D	E			
M16 x 1,5	5/16"	8,3	31	10	26	-	24	10	712.115.9*	4,3
M20 x 1,5	5/16"	8,3	31	10	26	-	24	10	712.114.9*	4,4
M16 x 1,5	3/8"	11	31	10	26	-	24	10	712.116.9	3,9
M20 x 1,5	3/8"	11	31	10	26	-	24	10	712.117.9	4
M20 x 1,5	1/2"	14,5	32	10	29	-	27	10	712.120.9	4,4
M25 x 1,5	3/4"	19,4	33	10	35	-	33	5	712.125.9	6,6
M32 x 1,5	1"	24,7	36	12	45	-	42	5	712.132.9	11,7
M40 x 1,5	1.1/4"	33,3	40	13	53	-	50	2	712.140.9	16
M50 x 1,5	1.1/2"	38	46	14	62	-	58	2	712.150.9	25,3
M63 x 1,5	2"	49	52	16	76	-	72	2	712.163.9	38,6

ISO 90° fitting, compact, male, stainless steel AISI-316

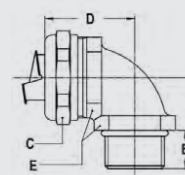

THREAD ISO	SEALTITE SIZE (INCH)	MIN. INTERNAL BORE (MM)	DIMENSIONS IN MM					STANDARD PACKAGE	ARTICLE NUMBER	WEIGHT (KG/100)
			A	B	C	D	E			
M16 x 1,5	5/16"	8,3	26	10	26	31	22	10	712.515.9*	7
M20 x 1,5	5/16"	8,3	26	10	26	32	24	10	712.514.9*	8,3
M16 x 1,5	3/8"	11	26	10	26	31	22	10	712.516.9	6,6
M20 x 1,5	3/8"	11	26	10	26	32	24	10	712.517.9	7,9
M20 x 1,5	1/2"	14,5	28	10	29	34	27	10	712.520.9	9,2
M25 x 1,5	3/4"	19,4	32	10	35	40	33	5	712.525.9	16,2
M32 x 1,5	1"	24,7	40	12	45	49	42	5	712.532.9	27,8
M40 x 1,5	1.1/4"	33,3	46	13	53	53	52	2	712.540.9	40,1
M50 x 1,5	1.1/2"	38	52	14	62	57	60	2	712.550.9	57,5
M63 x 1,5	2"	49	62	16	76	68	72	2	712.563.9	90,6

\* Sizes 1/4", 5/16", 2.1/2" and 3" do not have UL / CSA approval.

## COMPACT FITTINGS, IP 66 / IP 67, STAINLESS STEEL AISI-316

ISO cable-hose fitting, compact, male, stainless steel AISI-316, double EPDM seal according EN 45545-2, HL1 / HL2 / HL3, table R22 and R23

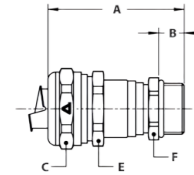

THREAD ISO	SEALTITE SIZE (INCH)	CLAMPING RANGE (MM)	DIMENSIONS IN MM					STANDARD PACKAGE	ARTICLE NUMBER	WEIGHT (KG/100)
			A	B	C	E	F			
M16 x 1,5	3/8"	4,0 - 9,5	50	10	26	24	18	10	712.716.9	6,8
M20 x 1,5	3/8"	4,0 - 9,5	50	10	26	24	22	10	712.717.9	7,4
M20 x 1,5	1/2"	6,0 - 13,0	53	10	29	27	22	10	712.720.9	7,6
M25 x 1,5	1/2"	6,0 - 13,0	54	10	29	27	27	5	712.722.9	9,0
M25 x 1,5	3/4"	10,5 - 18,0	56	10	35	33	27	5	712.725.9	11,7
M32 x 1,5	3/4"	10,5 - 18,0	58	12	35	33	35	5	712.728.9	15,0
M32 x 1,5	1"	16,0 - 24,7	61	12	45	42	35	5	712.732.9	20,3
M40 x 1,5	1"	16,0 - 24,7	63	13	45	42	43	2	712.735.9	24,5
M40 x 1,5	1.1/4"	22,0 - 32,0	69	13	53	50	43	2	712.740.9	28,6
M50 x 1,5	1.1/4"	22,0 - 32,0	70	14	53	50	55	1	712.745.9	34,5
M50 x 1,5	1.1/2"	29,5 - 38,0	78	14	62	58	55	1	712.750.9	46,0

NPT straight fitting, compact, male, stainless steel AISI-316

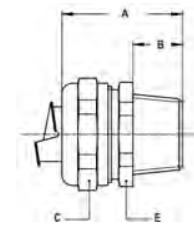

THREAD NPT	SEALTITE SIZE (INCH)	MIN. INTERNAL BORE (MM)	DIMENSIONS IN MM					STANDARD PACKAGE	ARTICLE NUMBER	WEIGHT (KG/100)
			A	B	C	D	E			
NPT 1/2"	5/16"	8,3	35	14	26	-	24	10	714.111.9*	4,8
NPT 1/2"	3/8"	11	35	14	26	-	24	10	714.112.9	4,4
NPT 1/2"	1/2"	14,5	36	14	29	-	27	10	714.116.9	5
NPT 3/4"	3/4"	19,4	37	14	35	-	33	5	714.120.9	7
NPT 1"	1"	24,7	40	16	45	-	42	5	714.126.9	12,6
NPT 1.1/4"	1.1/4"	33,3	43	16	53	-	50	2	714.135.9	16,8
NPT 1.1/2"	1.1/2"	38	50	18	62	-	58	2	714.140.9	25,8
NPT 2"	2"	49	56	20	76	-	72	2	714.150.9	41,2
NPT 2.1/2"	2.1/2"	60,7	67	25	90	-	85	1	714.163.9*	83,6
NPT 3"	3"	75,5	73	27	108	-	102	1	714.175.9*	113,9

NPT 45° fitting, compact, male, stainless steel AISI-316

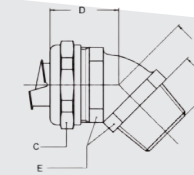

THREAD NPT	SEALTITE SIZE (INCH)	MIN. INTERNAL BORE (MM)	DIMENSIONS IN MM					STANDARD PACKAGE	ARTICLE NUMBER	WEIGHT (KG/100)
			A	B	C	D	E			
NPT 1/2"	5/16"	8,3	24	14	26	28	24	10	714.211.9*	8,1
NPT 1/2"	3/8"	11	24	14	26	28	24	10	714.212.9	7,7
NPT 1/2"	1/2"	14,5	25	14	29	30	27	10	714.216.9	8,8
NPT 3/4"	3/4"	19,4	27	14	35	33	33	5	714.220.9	14,5
NPT 1"	1"	24,7	32	16	45	38	42	5	714.226.9	24
NPT 1.1/4"	1.1/4"	33,3	36	16	53	39	52	2	714.235.9	35,5
NPT 1.1/2"	1.1/2"	38	39	18	62	46	60	2	714.240.9	51
NPT 2"	2"	49	44	20	76	53	72	2	714.250.9	85,5
NPT 3"	3"	75,5	61	27	108	74	102	1	714.275.9*	220

Sealtite fittings



## COMPACT FITTINGS, IP 66 / IP 67, STAINLESS STEEL AISI-316

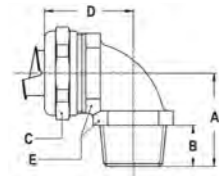

NPT 90° fitting, compact, male, stainless steel AISI-316



THREAD NPT	SEALTITE SIZE (INCH)	MIN. INTERNAL BORE (MM)	DIMENSIONS IN MM					STANDARD PACKAGE	ARTICLE NUMBER	WEIGHT (KG/100)
			A	B	C	D	E			
NPT 1/2"	5/16"	8,3	30	14	26	32	24	10	714.511.9*	8,6
NPT 1/2"	3/8"	11	30	14	26	32	24	10	714.512.9	8,2
NPT 1/2"	1/2"	14,5	32	14	29	34	27	10	714.516.9	9,6
NPT 3/4"	3/4"	19,4	36	14	35	40	33	5	714.520.9	16,7
NPT 1"	1"	24,7	44	16	45	49	42	5	714.526.9	28,3
NPT 1.1/4"	1.1/4"	33,3	49	16	53	53	52	2	714.535.9	41,4
NPT 1.1/2"	1.1/2"	38	56	18	62	57	60	2	714.540.9	57,3
NPT 2"	2"	49	66	20	76	68	72	2	714.550.9	90,8
NPT 3"	3"	75,5	92	27	108	97	102	1	714.575.9*	289

\* Sizes 1/4", 5/16", 2.1/2" and 3" do not have UL / CSA approval.

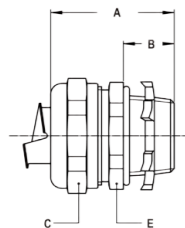

NPT straight fitting, compact, male, stainless steel AISI-316, including washer and AISI-304 locknut



THREAD NPT	SEALTITE SIZE (INCH)	MIN. INTERNAL BORE (MM)	DIMENSIONS IN MM					STANDARD PACKAGE	ARTICLE NUMBER	WEIGHT (KG/100)
			A	B	C	D	E			
NPT 1/2"	5/16"	8,3	35	14	26	-	24	10	714.111.92*	5,3
NPT 1/2"	3/8"	11	35	14	26	-	24	10	714.112.92	4,9
NPT 1/2"	1/2"	14,5	36	14	29	-	27	10	714.116.92	5,5
NPT 3/4"	3/4"	19,4	37	14	35	-	33	5	714.120.92	7,8
NPT 1"	1"	24,7	40	16	45	-	42	5	714.126.92	13,9
NPT 1.1/4"	1.1/4"	33,3	43	16	53	-	50	2	714.135.92	18,6
NPT 1.1/2"	1.1/2"	38	50	18	62	-	58	2	714.140.92	28
NPT 2"	2"	49	56	20	76	-	72	2	714.150.92	45
NPT 2.1/2"	2.1/2"	60,7	67	25	90	-	85	1	714.163.92*	87,1
NPT 3"	3"	75,5	73	27	108	-	102	1	714.175.92*	119,5

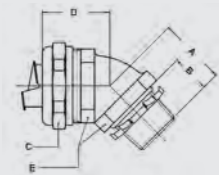

NPT 45° fitting, compact, male, stainless steel AISI-316, including washer and AISI-304 locknut



THREAD NPT	SEALTITE SIZE (INCH)	MIN. INTERNAL BORE (MM)	DIMENSIONS IN MM					STANDARD PACKAGE	ARTICLE NUMBER	WEIGHT (KG/100)
			A	B	C	D	E			
NPT 1/2"	5/16"	8,3	24	14	26	28	24	10	714.211.92*	8,6
NPT 1/2"	3/8"	11	24	14	26	28	24	10	714.212.92	8,2
NPT 1/2"	1/2"	14,5	25	14	29	30	27	10	714.216.92	9,3
NPT 3/4"	3/4"	19,4	27	14	35	33	33	5	714.220.92	15,3
NPT 1"	1"	24,7	32	16	45	38	42	5	714.226.92	25,3
NPT 1.1/4"	1.1/4"	33,3	36	16	53	39	52	2	714.235.92	37,3
NPT 1.1/2"	1.1/2"	38	39	18	62	46	60	2	714.240.92	53,2
NPT 2"	2"	49	44	20	76	53	72	2	714.250.92	88,3
NPT 3"	3"	75,5	61	27	108	74	102	1	714.275.92*	225,6

## COMPACT FITTINGS, IP 66 / IP 67, STAINLESS STEEL AISI-316

NPT 90° fitting, compact, male, stainless steel AISI-316, including washer and AISI-304 locknut

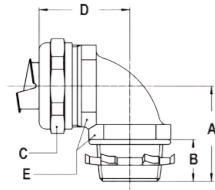

THREAD NPT	SEALTITE SIZE (INCH)	MIN. INTERNAL BORE (MM)	DIMENSIONS IN MM					STANDARD PACKAGE	ARTICLE NUMBER	WEIGHT (KG/100)
			A	B	C	D	E			
NPT 1/2"	5/16"	8,3	30	14	26	32	24	10	714.511.92*	9,1
NPT 1/2"	3/8"	11	30	14	26	32	24	10	714.512.92	8,7
NPT 1/2"	1/2"	14,5	32	14	29	34	27	10	714.516.92	10,1
NPT 3/4"	3/4"	19,4	36	14	35	40	33	5	714.520.92	17,5
NPT 1"	1"	24,7	44	16	45	49	42	5	714.526.92	29,6
NPT 1.1/4"	1.1/4"	33,3	49	16	53	53	52	2	714.535.92	43,2
NPT 1.1/2"	1.1/2"	38	56	18	62	57	60	2	714.540.92	59,5
NPT 2"	2"	49	66	20	76	68	72	2	714.550.92	93,6
NPT 3"	3"	75,5	92	27	108	97	102	1	714.575.92*	294,6

\* Sizes 1/4", 5/16", 2.1/2" and 3" do not have UL / CSA approval.

NPT cable-hose fitting, compact, male, stainless steel AISI-316, double EPDM seal according EN 45545-2, HL1 / HL2 / HL3, table R22 and R23 incl. NBR flat seal and stainless steel AISI-304 locknut

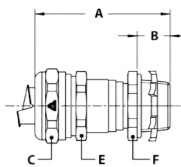

THREAD NPT	SEALTITE SIZE (INCH)	CLAMPING RANGE (MM)	DIMENSIONS IN MM					STANDARD PACKAGE	ARTICLE NUMBER	WEIGHT (KG/100)
			A	B	C	E	F			
NPT 1/2"	3/8"	4,0 - 9,5	54	14	26	24	24	10	714.712.92	8,0
NPT 1/2"	1/2"	6,0 - 13,0	57	14	29	27	24	10	714.716.92	8,9
NPT 3/4"	1/2"	6,0 - 13,0	58	14	29	27	30	5	714.718.92	10,3
NPT 3/4"	3/4"	10,5 - 18,0	60	14	35	33	30	5	714.720.92	13,2
NPT 1"	3/4"	10,5 - 18,0	62	16	35	33	38	5	714.723.92	16,5
NPT 1"	1"	16,0 - 24,7	65	16	45	42	38	5	714.726.92	22,2
NPT 1.1/4"	1"	16,0 - 24,7	66	16	45	42	48	2	714.730.92	26,4
NPT 1.1/4"	1.1/4"	22,0 - 32,0	72	16	53	50	48	2	714.735.92	31,8
NPT 1.1/2"	1.1/4"	22,0 - 32,0	74	18	53	50	55	1	714.738.92	36,5
NPT 1.1/2"	1.1/2"	29,5 - 38,0	92	18	62	58	55	1	714.740.92	53,0

Sealtite fittings

Grounding ferrule, stainless steel AISI-316



THREAD	SEALTITE SIZE (INCH)	MIN. INTERNAL BORE (MM)	DIMENSIONS IN MM					STANDARD PACKAGE	ARTICLE NUMBER	WEIGHT (KG/100)
			A	B	C	D	E			
-	3/8"	10,2	-	-	-	-	-	10	815.011.9	0,6
-	1/2"	13,9	-	-	-	-	-	10	815.016.9	0,8
-	3/4"	18,5	-	-	-	-	-	5	815.021.9	1,4
-	1"	23,8	-	-	-	-	-	5	815.029.9	2,8

# Standard fittings, IP 67, stainless steel AISI-316



## ANACONDA STAINLESS STEEL AISI-316 FITTINGS FOR ANACONDA SEALTITE

The stainless steel AISI-316 Anaconda fittings can be used with all types of Anaconda Sealtite (except CNP) and offer a superior corrosion resistance. These stainless steel Anaconda fittings are mostly used in the off-shore, chemical and food industry. Because of the UL & CSA approvals the fittings are also suitable for export projects outside Europe.

### Material & Construction:

**Construction:** Stainless steel AISI-316 fitting, consisting of 4 parts (counter nut, clamping ring, ferrule and body).

**Material:** Counter nut and body are stainless steel AISI-316 and the ferrule is from nickel plated brass. Clamping ring and insert are from PA6 (red for ISO metric, blue for Pg and white for NPT).

**Special approvals:** UL-514B and CSA C 22.2 (combined UL / CSA [CUL] file # E 234207).

Suitable for use in hazardous environments according to NEC:

- Article 501.10 (B) (2).  
Class I, Division 2.

- Article 502.10 (A) (2) and (B) (2).  
Class II, Division 1 and 2.
- Article 503.10 (A) (3) and (B).  
Class III, Division 1 and 2.

**Temperature:** -45 °C till +105 °C continuous.

**Protection class:** IP 67 (dust-proof, water-tight).

**Colour:** Metal coloured.

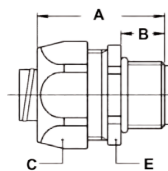

ISO straight fitting, male, stainless steel AISI-316



THREAD ISO	SEALTITE SIZE (INCH)	MIN. INTERNAL BORE (MM)	DIMENSIONS IN MM					STANDARD PACKAGE	ARTICLE NUMBER	WEIGHT (KG/100)
			A	B	C	D	E			
M16 x 1,5	5/16"	8,3	35	12	27	-	24	10	812.115.9*	5,2
M20 x 1,5	5/16"	8,3	36	13	27	-	24	10	812.114.9*	5,2
M16 x 1,5	3/8"	10,2	35	12	27	-	24	10	812.116.9	4,8
M20 x 1,5	3/8"	10,2	36	13	27	-	24	10	812.117.9	4,8
M20 x 1,5	1/2"	13,9	37	13	30	-	27	10	812.120.9	5,9
M25 x 1,5	3/4"	18,5	40	15	36	-	36	5	812.125.9	7,9
M32 x 1,5	1"	23,8	46	15	46	-	46	5	812.132.9	17,5

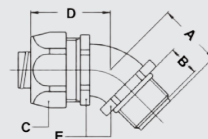

ISO 45° fitting, male, stainless steel AISI-316



THREAD ISO	SEALTITE SIZE (INCH)	MIN. INTERNAL BORE (MM)	DIMENSIONS IN MM					STANDARD PACKAGE	ARTICLE NUMBER	WEIGHT (KG/100)
			A	B	C	D	E			
M16 x 1,5	5/16"	8,3	23	12	27	33	22	10	812.215.9*	7,7
M20 x 1,5	5/16"	8,3	24	13	27	33	22	10	812.214.9*	7,8
M16 x 1,5	3/8"	10,2	23	12	27	33	22	10	812.216.9	7,3
M20 x 1,5	3/8"	10,2	24	13	27	33	22	10	812.217.9	7,4
M20 x 1,5	1/2"	13,9	25	13	30	33	27	10	812.220.9	10,5
M25 x 1,5	3/4"	18,5	30	15	36	36	33	5	812.225.9	13,6

\* Sizes 1/4" and 5/16" do not have UL / CSA approval.

## STANDARD FITTINGS, IP 67, STAINLESS STEEL AISI-316

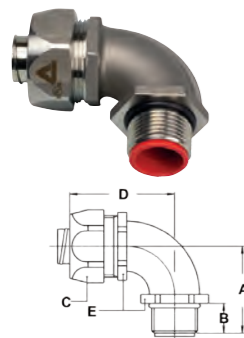

ISO 90° fitting, male, stainless steel AISI-316



THREAD ISO	SEALTITE SIZE (INCH)	MIN. INTERNAL BORE (MM)	DIMENSIONS IN MM					STANDARD PACKAGE	ARTICLE NUMBER	WEIGHT (KG/100)
			A	B	C	D	E			
M16 x 1,5	5/16"	8,3	32	12	27	42	22	10	812.515.9*	8,6
M20 x 1,5	5/16"	8,3	33	13	27	42	22	10	812.514.9*	8,8
M16 x 1,5	3/8"	10,2	32	12	27	42	22	10	812.516.9	8,2
M20 x 1,5	3/8"	10,2	33	13	27	42	22	10	812.517.9	8,4
M20 x 1,5	1/2"	13,9	36	13	30	43	27	10	812.520.9	12,6
M25 x 1,5	3/4"	18,5	43	15	36	48	33	5	812.525.9	19,2

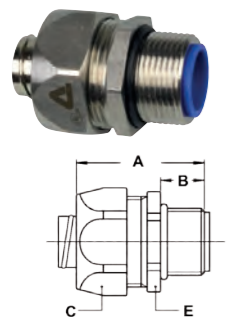

Pg straight fitting, male, stainless steel AISI-316



THREAD PG	SEALTITE SIZE (INCH)	MIN. INTERNAL BORE (MM)	DIMENSIONS IN MM					STANDARD PACKAGE	ARTICLE NUMBER	WEIGHT (KG/100)
			A	B	C	D	E			
Pg 16	1/2"	13,9	37	13	30	-	27	10	810.116.9	6,3
Pg 21	3/4"	18,5	40	15	36	-	36	5	810.121.9	8,4
Pg 29	1"	23,8	46	15	46	-	46	5	810.129.9	25

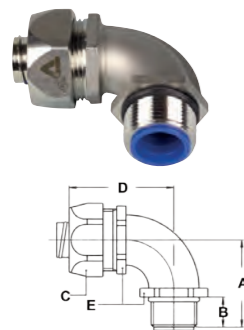

Pg 90° fitting, male, stainless steel AISI-316



THREAD PG	SEALTITE SIZE (INCH)	MIN. INTERNAL BORE (MM)	DIMENSIONS IN MM					STANDARD PACKAGE	ARTICLE NUMBER	WEIGHT (KG/100)
			A	B	C	D	E			
Pg 13,5	5/16"	8,3	32	12	27	42	22	10	810.514.9*	9,3
Pg 13,5	3/8"	10,2	32	12	27	42	22	10	810.513.9	8,9
Pg 16	1/2"	13,9	36	13	30	43	27	10	810.516.9	15,3

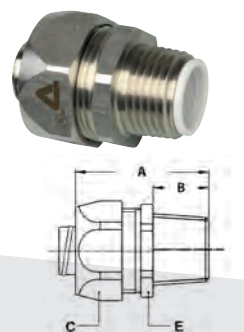

NPT straight fitting, male, stainless steel AISI-316



THREAD NPT	SEALTITE SIZE (INCH)	MIN. INTERNAL BORE (MM)	DIMENSIONS IN MM					STANDARD PACKAGE	ARTICLE NUMBER	WEIGHT (KG/100)
			A	B	C	D	E			
1/2" NPT	5/16"	8,3	37	13	27	-	24	10	814.111.9*	6
1/2" NPT	3/8"	10,2	37	13	27	-	24	10	814.112.9	5,6
1/2" NPT	1/2"	13,9	37	13	30	-	27	10	814.116.9	6,2
3/4" NPT	3/4"	18,5	40	15	36	-	36	5	814.120.9	8,9
1" NPT	1"	23,8	46	15	46	-	46	5	814.126.9	25

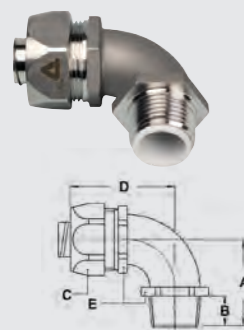

NPT 90° fitting, male, stainless steel AISI-316



THREAD NPT	SEALTITE SIZE (INCH)	MIN. INTERNAL BORE (MM)	DIMENSIONS IN MM					STANDARD PACKAGE	ARTICLE NUMBER	WEIGHT (KG/100)
			A	B	C	D	E			
1/2" NPT	5/16"	8,3	36	13	27	43	22	10	814.511.9*	13,7
1/2" NPT	3/8"	10,2	36	13	27	43	22	10	814.512.9	13,3
1/2" NPT	1/2"	13,9	36	13	30	43	27	10	814.516.9	14,6

\* Sizes 1/4" and 5/16" do not have UL / CSA approval.

Sealtite fittings

# Swivel fittings, IP 67, stainless steel AISI-316



## ANACONDA SWIVEL FITTINGS, STAINLESS STEEL AISI-316 FOR ANACONDA SEALTITE

The stainless steel AISI-316 Anaconda swivel fittings can be used with all types of Anaconda Sealтите (except CNP). This Anaconda fitting is a universal fitting with a special swivel mechanism for a higher tensile strength and a high water proof protection (IP 67). All ferrules are turned nickel plated brass versions for a better fit. The high quality stainless steel AISI-316 offers a superb corrosion protection in combination with a nice appearance.

### Material & Construction:

**Construction:** Stainless steel AISI-316 fitting, consisting of 4 parts (counter nut, clamping ring, ferrule and body).

**Material:** Counter nut and body are stainless steel AISI-316. Clamping ring is made from PA6 and the ferrule is made from nickel plated brass.

**Temperature:** -45 °C till +105 °C continuous.

**Protection class:** IP 67.

**Colour:** Metal coloured.

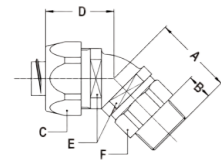

NPT 45° swivel fitting, male, stainless steel AISI-316



THREAD NPT	SEALTITE SIZE (INCH)	MIN. INTERNAL BORE (MM)	DIMENSIONS IN MM						STANDARD PACKAGE	ARTICLE NUMBER	WEIGHT (KG/100)
			A	B	C	D	E	F			
NPT 1/2"	3/8"	10,4	36	12	27	28	22	22	10	819.212.9	11,5
NPT 1/2"	1/2"	13,8	36	12	30	30	27	25	10	819.216.9	14
NPT 3/4"	3/4"	17,4	47	14	36	37	33	33	5	838.220.9	22
NPT 1"	1"	23,4	54	15	46	46	42	42	5	838.226.9	37

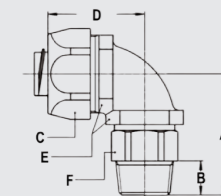

NPT 90° swivel fitting, male, stainless steel AISI-316



THREAD NPT	SEALTITE SIZE (INCH)	MIN. INTERNAL BORE (MM)	DIMENSIONS IN MM						STANDARD PACKAGE	ARTICLE NUMBER	WEIGHT (KG/100)
			A	B	C	D	E	F			
NPT 1/2"	3/8"	10,4	41	12	27	35	22	22	10	819.512.9	12
NPT 1/2"	1/2"	13,8	41	12	30	37	27	25	10	819.516.9	14
NPT 3/4"	3/4"	17,4	60	14	36	50	33	33	5	838.520.9	23,5
NPT 1"	1"	23,4	102	15	46	60	42	42	5	838.526.9	42



# Food grade fittings, IP 68, stainless steel AISI-316

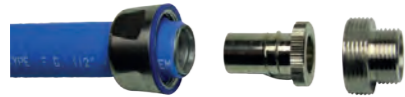

## ANACONDA COMPACT HYGIENIC DESIGN, STAINLESS STEEL AISI-316 "FOOD FITTING" FOR ANACONDA SEALTITE

Anaconda compact hygienically designed, stainless steel AISI-316 food fittings can be used with all types of Anaconda Sealtite conduits (except CNP). These stainless steel compact food fittings are designed with rounded corners and have a smooth contourless profile to minimise the risk of bacteria deposits and to promote easy cleaning. They display excellent resistance to corrosion.

### Material & Construction:

**Construction:** Stainless steel AISI-316 fitting, consisting of 5 parts (counter nut, upper seal, clamping ring, ferrule and body).

**Material:** Counter nut and body are stainless steel AISI-316 and the ferrule is from nickel plated brass. The blue upper seal and clamping ring are made of TPE in accordance with FDA / CFR 21.

**Special approvals:** Special TPE seals, halogen free, specially formulated for food and beverage

applications per FDA guideline CFR 21. Evaluated and in compliance with the current criteria for Hygienic Equipment Design of the EHEDG (report .DTU CHD DR 2017 8037-088-3).

**Temperature:** -45 °C till +105 °C continuous.

**Protection class:** IP 68 according EN 60529, IP69 according DIN 40050-9 (till 40 Bar high pressure).

**Colour:** Metal coloured.

Sealtite fittings

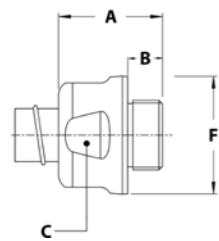

ISO straight, compact, food grade fitting, male, stainless steel AISI-316



THREAD ISO	SEALTITE SIZE (INCH)	MIN. INTERNAL BORE (MM)	DIMENSIONS IN MM					STANDARD PACKAGE	ARTICLE NUMBER	WEIGHT (KG/100)
			A	B	C	D	F			
M16 x 1,5	5/16"	8,3	29	10	24	-	28	10	742.015.9	5,2
M16 x 1,5	3/8"	10,4	29	10	27	-	31	10	742.016.9	5,7
M20 x 1,5	1/2"	13,8	30	10	30	-	34	10	742.020.9	6,9
M25 x 1,5	3/4"	18,5	31	10	36	-	40	5	742.025.9	9,8
M32 x 1,5	1"	23,8	35	12	44	-	48	5	742.032.9	17,2
M40 x 1,5	1.1/4"	31,8	35	13	53	-	57	2	742.040.9	21,7
M50 x 1,5	1.1/2"	36,8	38	14	60	-	65	1	742.050.9	32,6
M63 x 1,5	2"	47,8	40	16	72	-	78	1	742.063.9	44,3

# Food grade fittings, IP 68, stainless steel AISI-316



## ANACONDA HYGIENIC DESIGN, STAINLESS STEEL AISI-316 "FOOD FITTING" FOR ANACONDA SEALTITE

Anaconda hygienically designed, stainless steel AISI-316 food fittings can be used with all types of Anaconda Sealtite conduits (except CNP). These stainless steel fittings are designed with rounded corners and have a smooth contourless profile to minimise the risk of bacteria deposits and to promote easy cleaning. They display excellent resistance to corrosion.

### Material & Construction:

**Construction:** Stainless steel AISI-316 fitting, consisting of 6 parts (lower seal, counter nut, upper seal, clamping ring, ferrule and body).

**Material:** Counter nut and body are stainless steel AISI-316 and the ferrule is from nickel plated brass. Clamping ring is from PA6. The blue rubber seals are made of TPE in accordance with FDA / CFR 21.

**Special approvals:** Special TPE seals, halogen free, specially formulated for food and beverage applications per FDA guideline CFR 21.

**Temperature:** -45 °C till +105 °C continuous.

**Protection class:** IP 68 according EN 60529, IP69 according DIN 40050-9 (till 40 Bar high pressure).

**Colour:** Metal coloured.

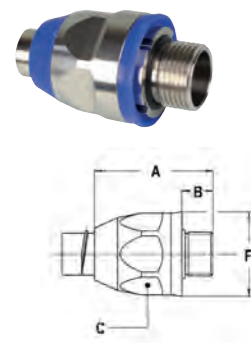

ISO straight food grade fitting, male, stainless steel AISI-316



THREAD ISO	SEALTITE SIZE (INCH)	MIN. INTERNAL BORE (MM)	DIMENSIONS IN MM					STANDARD PACKAGE	ARTICLE NUMBER	WEIGHT (KG/100)
			A	B	C	D	F			
M16 x 1,5	3/8"	10,4	48	12	27	-	31	10	832.016.9	6,6
M20 x 1,5	1/2"	13,8	50	13	30	-	34	10	832.020.9	8
M25 x 1,5	3/4"	18,5	57	15	36	-	41	5	832.025.9	11,8
M32 x 1,5	1"	23,8	68	15	46	-	53	5	832.032.9	22,8
M40 x 1,5	1.1/4"	31,8	75	16	54	-	62	2	832.040.9	34,2
M50 x 1,5	1.1/2"	36,8	81	18	63	-	70	1	832.050.9	38,6
M63 x 1,5	2"	47,8	88	20	77	-	85	1	832.063.9	76,6

# Food grade fittings, IP 67, nickel plated brass



## ANACONDA SMOOTH, MIRROR-POLISHED "ELBOW FOOD FITTING" FOR ANACONDA SEALTITE

Anaconda smooth mirror polished elbow fittings can be used with all types of Anaconda Sealtite (except CNP) and offer a high corrosion resistance. Because of the special mirror-polished treatment these fittings are specifically smooth and give a good protection especially for the pharmaceutical and food industry. The mirror polished treatment reduces the risk of bacterial formation and permits easy cleaning.

### Material & Construction:

**Construction:** Nickel plated brass fitting, consisting of 4 parts (counter nut, clamping ring, ferrule and body).

**Material:** Counter nut, body and ferrule are nickel plated brass with exception of size 3/8" till 1" where the ferrule is from galvanised steel.

Clamping ring and inserts are made from PA6 (red for ISO metric).

**Temperature:** -45 °C till +105 °C continuous.

**Protection class:** IP 67 (dust-proof, water-tight).

**Colour:** Metal coloured.

Sealtite fittings

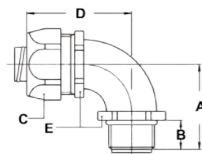

ISO 90° fitting, male, mirror-polished nickel plated brass



THREAD ISO	SEALTITE SIZE (INCH)	MIN. INTERNAL BORE (MM)	DIMENSIONS IN MM					STANDARD PACKAGE	ARTICLE NUMBER	WEIGHT (KG/100)
			A	B	C	D	E			
M16 x 1,5	5/16"	8,3	32	12	26	42	22	10	818.915.1	8,6
M20 x 1,5	5/16"	8,3	33	13	26	42	22	10	818.914.1	8,8
M16 x 1,5	3/8"	10,2	32	12	26	42	22	10	818.916.1	8,2
M20 x 1,5	3/8"	10,2	33	13	26	42	22	10	818.917.1	8,4
M20 x 1,5	1/2"	13,9	36	13	29	43	27	10	818.920.1	12,6
M25 x 1,5	3/4"	18,5	43	15	35	48	33	5	818.925.1	19,2
M32 x 1,5	1"	23,8	48	15	45	59	42	5	818.932.1	31,6

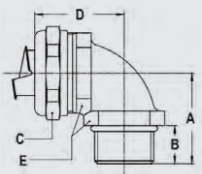

ISO 90° fitting, compact, male, mirror-polished nickel plated brass



THREAD ISO	SEALTITE SIZE (INCH)	MIN. INTERNAL BORE (MM)	DIMENSIONS IN MM					STANDARD PACKAGE	ARTICLE NUMBER	WEIGHT (KG/100)
			A	B	C	D	E			
M40 x 1,5	1.1/4"	33,3	46	13	53	53	52	2	718.940.1	40,1
M50 x 1,5	1.1/2"	38	52	14	62	57	60	2	718.950.1	57,5
M63 x 1,5	2"	49	62	16	76	68	72	2	718.963.1	90,6

# Anamet fittings, IP 67, aluminum



## ANAMET ALUMINUM FITTINGS FOR SEALTITE TYPE EF-L

Anaconda aluminum fittings are made for use with type EF-L aluminum conduit. They are very light, easy to install and connect to the conduit and provide very good corrosion resistance.

### Material & Construction:

**Construction:** Aluminum fitting, consisting of 3 parts (counter nut, ferrule and body).

**Material:** Counter nut, ferrule and body are aluminum. The aluminum used is copper free.

**Special approvals:** UL-514B (file #E14814) and CSA C 22.2 (file # 065178). Nema; FB1.

**Temperature:** -55 °C till +300 °C continuous.

**Protection class:** IP 67 (dust-proof, water-tight).

**Colour:** Metal shining.

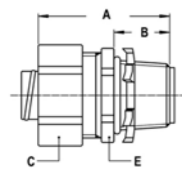

NPT straight fitting, male, aluminum (including aluminum lock nut).



THREAD NPT	EF-L SIZE (INCH)	MIN. INTERNAL BORE (MM)	DIMENSIONS IN MM					STANDARD PACKAGE	ARTICLE NUMBER	WEIGHT (KG/100)
			A	B	C	D	E			
NPT 1/2"	3/8"	10,4	37	15	26	-	24	25	298.012.6	2,4
NPT 1/2"	1/2"	13,7	37	15	29	-	27	25	298.016.6	2,6
NPT 3/4"	3/4"	18,8	38	15	35	-	33	25	298.020.6	3,7
NPT 1"	1"	24,2	44	18	42	-	40	5	298.026.6	5,5
NPT 1.1/4"	1.1/4"	31,6	54	18	56	-	55	5	298.035.6	13,6
NPT 1.1/2"	1.1/2"	36,8	60	18	64	-	61	2	298.040.6	19
NPT 2"	2"	48	64	18	77	-	77	1	298.050.6	27,6

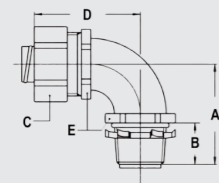

NPT 90° fitting, male, aluminum (including aluminum lock nut).



THREAD NPT	EF-L SIZE (INCH)	MIN. INTERNAL BORE (MM)	DIMENSIONS IN MM					STANDARD PACKAGE	ARTICLE NUMBER	WEIGHT (KG/100)
			A	B	C	D	E			
NPT 1/2"	3/8"	10,4	32	15	26	36	27	25	298.912.6	3,8
NPT 1/2"	1/2"	13,7	32	15	29	36	27	25	298.916.6	3,9
NPT 3/4"	3/4"	18,8	37	15	35	44	34	10	298.920.6	6
NPT 1"	1"	24,2	44	18	42	51	40	5	298.926.6	9,3
NPT 1.1/4"	1.1/4"	31,6	46	18	56	58	-	5	298.935.6	18,7
NPT 1.1/2"	1.1/2"	36,8	62	18	64	81	-	2	298.940.6	30,7
NPT 2"	2"	48	67	18	77	91	-	1	298.950.6	45,2

# Anamet fittings, IP 67, zinc die cast



## ANAMET ZINC DIECAST FITTING FOR ANACONDA SEALTITE

The zinc diecast Anamet fittings are especially for the large sizes Anaconda SealTite (with exception of CNP). This Anamet fitting offers good corrosion protection in combination with a smooth appearance.

### Material & Construction:

**Construction:** Zinc diecast fitting, consisting of 4 parts (counter nut, clamping ring, ferrule and body).

**Material:** Counter nut and body are zinc diecasted, ferrule is steel plated. Clamping rings are from PA6.

**Temperature:** -45 °C till +105 °C continuous.

**Protection class:** IP 67.

**Colour:** Metal coloured.

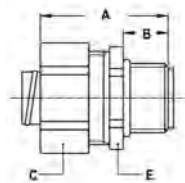

ISO straight fitting, male, zinc diecast



THREAD ISO	SEALTITE SIZE (INCH)	MIN. INTERNAL BORE (MM)	DIMENSIONS IN MM					STANDARD PACKAGE	ARTICLE NUMBER	WEIGHT (KG/100)
			A	B	C	D	E			
M50 x 1,5	1.1/2"	37,5	47	15	59	-	57	2	293.040.0	21,6
M63 x 1,5	2"	48,5	55	19	74	-	73	2	293.050.0	34

Sealtite fittings

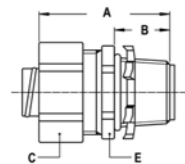

NPT straight fitting, male, zinc diecast



THREAD NPT	SEALTITE SIZE (INCH)	MIN. INTERNAL BORE (MM)	DIMENSIONS IN MM					STANDARD PACKAGE	ARTICLE NUMBER	WEIGHT (KG/100)
			A	B	C	D	E			
NPT 2.1/2"	2.1/2"	61	71	24	90	-	86	1	294.063.0	67,4
NPT 3"	3"	74	75	26	108	-	104	1	294.075.0	96,6
NPT 4"	4"	95	80	28	134	-	128	1	294.099.0	125
NPT 5"	5"	121	82	30	-	-	-	1	294.125.0	-

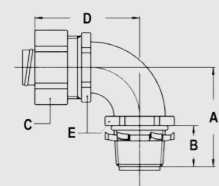

NPT 90° fitting, male, zinc diecast



THREAD NPT	SEALTITE SIZE (INCH)	MIN. INTERNAL BORE (MM)	DIMENSIONS IN MM					STANDARD PACKAGE	ARTICLE NUMBER	WEIGHT (KG/100)
			A	B	C	D	E			
NPT 2.1/2"	2.1/2"	61	86	24	90	104	86	1	294.963.0	117,8
NPT 3"	3"	74	98	26	108	112	104	1	294.975.0	172,8
NPT 4"	4"	95	112	28	134	127	128	1	294.999.0	278,6



# Anamet fittings, IP 67, galvanised steel



## ANAMET GALVANISED STEEL FITTINGS FOR SEALTITE

The galvanised steel Anamet fittings can be used with all types of Anaconda SealTite (except CNP) and are particularly used where a wider temperature range is required (for instance with type HCX). Because of the UL & CSA approvals the fittings are also suitable for export projects outside Europe.

### Material & Construction:

**Construction:** Galvanised steel fitting, consisting of 3 parts (counter nut, ferrule and body).

**Material:** Counter nut, ferrule and body are galvanised steel from size 3" till 1", as from size 1.1/4" the body is made from alleable iron. Inserts are made from PAG (green for ISO metric, blue for Pg and white for NPT).

**Special approvals:** UL-514B (file # E 11853) and CSA C22.2 (file # 65178).

Suitable for use in hazardous environments

according NEC:

- Article 501.10 (B) (2) Class I, Division 2.
- Article 502.10 (A) (2) and (B) (2). Class II, Division 1 and 2.
- Article 503.10 (A) (3) and (B). Class III, Division 1 and 2.

**Temperature:** -55 °C till +300 °C continuous.

**Protection class:** IP 67.

**Colour:** Metal coloured.

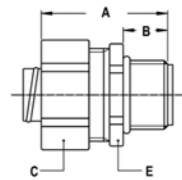

ISO straight fitting, male, galvanised steel



THREAD ISO	SEALTITE SIZE (INCH)	MIN. INTERNAL BORE (MM)	DIMENSIONS IN MM					STANDARD PACKAGE	ARTICLE NUMBER	WEIGHT (KG/100)
			A	B	C	D	E			
M16 x 1,5	3/8"	9,7	37	15	26	-	24	25	295.012.0	6,4
M20 x 1,5	1/2"	13,7	37	15	29	-	27	25	295.016.0	6,8
M25 x 1,5	3/4"	18,8	38	15	35	-	33	25	295.020.0	10
M32 x 1,5	1"	24,2	44	18	42	-	40	10	295.026.0	15

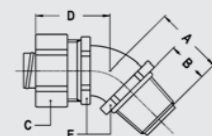

ISO 45° fitting, male, galvanised steel



THREAD ISO	SEALTITE SIZE (INCH)	MIN. INTERNAL BORE (MM)	DIMENSIONS IN MM					STANDARD PACKAGE	ARTICLE NUMBER	WEIGHT (KG/100)
			A	B	C	D	E			
M16 x 1,5	3/8"	9,7	22	15	26	29	27	25	295.412.0	7,8
M20 x 1,5	1/2"	13,7	24	15	29	29	27	25	295.416.0	8,2
M25 x 1,5	3/4"	18,8	27	15	35	32	32	10	295.420.0	16,8
M32 x 1,5	1"	24,2	30	18	42	37	40	5	295.426.0	21,6

## ANAMET FITTINGS, IP 67, GALVANISED STEEL

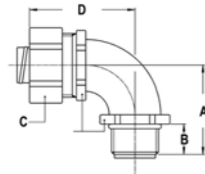

ISO 90° fitting, male, galvanised steel



THREAD ISO	SEALTITE SIZE (INCH)	MIN. INTERNAL BORE (MM)	DIMENSIONS IN MM					STANDARD PACKAGE	ARTICLE NUMBER	WEIGHT (KG/100)
			A	B	C	D	E			
M16 x 1,5	3/8"	9,7	32	15	26	34	27	25	295.912.0	10
M20 x 1,5	1/2"	13,7	33	15	29	38	27	25	295.916.0	10,6
M25 x 1,5	3/4"	18,8	37	15	35	44	34	10	295.920.0	21,4
M32 x 1,5	1"	24,2	44	18	42	51	40	5	295.926.0	25,6

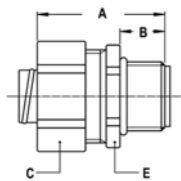

Pg straight fitting, male, galvanised steel



THREAD PG	SEALTITE SIZE (INCH)	MIN. INTERNAL BORE (MM)	DIMENSIONS IN MM					STANDARD PACKAGE	ARTICLE NUMBER	WEIGHT (KG/100)
			A	B	C	D	E			
Pg 11	3/8"	9,7	37	15	26	-	24	25	299.011.0	6,8
Pg 13,5	3/8"	10,4	37	15	26	-	24	25	299.013.0	6,8
Pg 16	1/2"	13,7	38	15	29	-	27	25	299.016.0	7,2
Pg 21	3/4"	18,8	38	15	35	-	33	25	299.020.0	10,8
Pg 29	1"	24,2	44	18	42	-	40	5	299.026.0	15,6
Pg 36	1.1/4"	31,6	54	18	56	-	55	5	299.035.0	38,4
Pg 42	1.1/2"	36,8	62	18	64	-	61	1	299.040.0	56
Pg 48	2"	48	64	18	77	-	77	1	299.050.0	68

Sealtite fittings

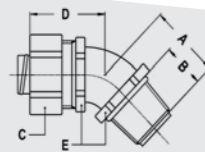

Pg 45° fitting, male, galvanised steel



THREAD PG	SEALTITE SIZE (INCH)	MIN. INTERNAL BORE (MM)	DIMENSIONS IN MM					STANDARD PACKAGE	ARTICLE NUMBER	WEIGHT (KG/100)
			A	B	C	D	E			
Pg 11	3/8"	9,7	22	15	26	29	27	25	299.411.0	8,2
Pg 13,5	3/8"	10,4	22	15	26	29	27	25	299.413.0	8,2
Pg 16	1/2"	13,7	24	15	29	29	27	25	299.416.0	8,2
Pg 21	3/4"	18,8	27	15	35	32	32	10	299.420.0	13,6
Pg 29	1"	24,2	33	18	42	37	-	5	299.426.0	22,4
Pg 36	1.1/4"	31,6	38	18	56	46	-	5	299.435.0	46,4
Pg 42	1.1/2"	36,8	44	18	64	55	-	1	299.440.0	63
Pg 48	2"	48	51	18	77	58	-	1	299.450.0	106

## ANAMET FITTINGS, IP 67, GALVANISED STEEL

Pg 90° fitting, male, galvanised steel

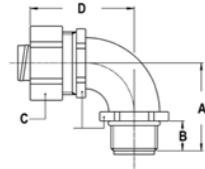

THREAD PG	SEALTITE SIZE (INCH)	MIN. INTERNAL BORE (MM)	DIMENSIONS IN MM					STANDARD PACKAGE	ARTICLE NUMBER	WEIGHT (KG/100)
			A	B	C	D	E			
Pg 11	3/8"	9,7	32	15	26	36	27	25	299.911.0	10,6
Pg 13,5	3/8"	10,4	32	15	26	36	27	25	299.913.0	10,6
Pg 16	1/2"	13,7	33	15	29	38	27	25	299.916.0	11
Pg 21	3/4"	18,8	37	15	35	44	34	10	299.920.0	17,8
Pg 29	1"	24,2	44	18	42	51	39	5	299.926.0	28,4
Pg 36	1.1/4"	31,6	44	18	56	61	-	5	299.935.0	52
Pg 42	1.1/2"	36,8	62	18	64	81	-	1	299.940.0	72
Pg 48	2"	48	69	18	77	91	-	1	299.950.0	124

NPT straight fitting, male, galvanised steel (including lock nut)

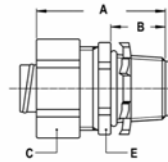

THREAD NPT	SEALTITE SIZE (INCH)	MIN. INTERNAL BORE (MM)	DIMENSIONS IN MM					STANDARD PACKAGE	ARTICLE NUMBER	WEIGHT (KG/100)
			A	B	C	D	E			
NPT 1/2"	3/8"	10,4	37	15	26	-	24	25	298.012.0	6,8
NPT 1/2"	1/2"	13,7	37	15	29	-	27	25	298.016.0	7,3
NPT 3/4"	3/4"	18,8	38	15	35	-	33	25	298.020.0	10,6
NPT 1"	1"	24,2	44	18	42	-	40	5	298.026.0	15,6
NPT 1.1/4"	1.1/4"	31,6	54	18	56	-	55	5	298.035.0	18,4
NPT 1.1/2"	1.1/2"	36,8	60	18	64	-	61	1	298.040.0	27
NPT 2"	2"	48	64	18	77	-	77	1	298.050.0	78
NPT 2.1/2"	2.1/2"	58,5	86	27	92	-	-	1	298.063.0	154
NPT 3"	3"	72	94	30	108	-	-	1	298.075.0	206
NPT 4"	4"	95	102	32	133	-	-	1	298.099.0	298

NPT 45° fitting, male, galvanised steel (including lock nut)

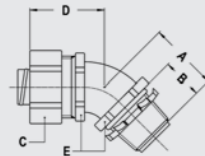

THREAD NPT	SEALTITE SIZE (INCH)	MIN. INTERNAL BORE (MM)	DIMENSIONS IN MM					STANDARD PACKAGE	ARTICLE NUMBER	WEIGHT (KG/100)
			A	B	C	D	E			
NPT 1/2"	3/8"	10,4	22	15	26	29	24	25	298.412.0	8,2
NPT 1/2"	1/2"	13,7	24	15	29	29	27	25	298.416.0	8,2
NPT 3/4"	3/4"	18,8	27	15	35	32	32	25	298.420.0	13,6
NPT 1"	1"	24,2	30	18	42	37	-	5	298.426.0	22,4
NPT 1.1/4"	1.1/4"	31,6	38	18	56	46	-	5	298.435.0	46,4
NPT 1.1/2"	1.1/2"	36,8	44	18	64	55	-	1	298.440.0	73
NPT 2"	2"	48	51	18	77	58	-	1	298.450.0	106
NPT 2.1/2"	2.1/2"	58,5	91	27	92	91	-	1	298.463.0	346
NPT 3"	3"	72	110	30	108	110	-	1	298.475.0	450
NPT 4"	4"	95	118	32	133	118	-	1	298.499.0	820

## ANAMET FITTINGS, IP 67, GALVANISED STEEL

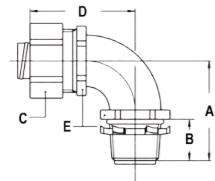

NPT 90° fitting, male, galvanised steel (including lock nut)



THREAD NPT	SEALTITE SIZE (INCH)	MIN. INTERNAL BORE (MM)	DIMENSIONS IN MM					STANDARD PACKAGE	ARTICLE NUMBER	WEIGHT (KG/100)
			A	B	C	D	E			
NPT 1/2"	3/8"	10,4	32	15	26	36	27	25	298.912.0	10,6
NPT 1/2"	1/2"	13,7	32	15	29	36	27	25	298.916.0	11
NPT 3/4"	3/4"	18,8	37	15	35	44	34	10	298.920.0	17,2
NPT 1"	1"	24,2	44	18	42	51	40	5	298.926.0	26,4
NPT 1.1/4"	1.1/4"	31,6	46	18	56	58	-	5	298.935.0	52,8
NPT 1.1/2"	1.1/2"	36,8	62	18	64	81	-	1	298.940.0	87
NPT 2"	2"	48	67	18	77	91	-	1	298.950.0	128
NPT 2.1/2"	2.1/2"	58,5	183	27	92	215	-	1	298.963.0	382
NPT 3"	3"	72	220	30	108	258	-	1	298.975.0	500
NPT 4"	4"	95	287	32	133	327	-	1	298.999.0	980

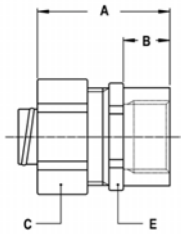

NPT straight fitting, female, galvanised steel



Sealtite fittings

THREAD NPT	SEALTITE SIZE (INCH)	MIN. INTERNAL BORE (MM)	DIMENSIONS IN MM					STANDARD PACKAGE	ARTICLE NUMBER	WEIGHT (KG/100)
			A	B	C	D	E			
NPT 1/2"	3/8"	10,4	33	11	26	-	24	25	298.612.0	5,9
NPT 1/2"	1/2"	13,7	34	11	29	-	27	25	298.616.0	6,4
NPT 3/4"	3/4"	18,8	36	12	35	-	33	25	298.620.0	9,6
NPT 1"	1"	24,2	42	15	42	-	40	5	298.626.0	14

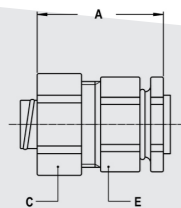

STN straight boxconnector fitting, galvanised steel



FOR HOLE MIN - MAX	SEALTITE SIZE (INCH)	MIN. INTERNAL BORE (MM)	DIMENSIONS IN MM					STANDARD PACKAGE	ARTICLE NUMBER	WEIGHT (KG/100)
			A	B	C	D	E			
22 - 25	3/8"	10,4	37	-	26	-	26	25	298.212.0	8,2
22 - 25	1/2"	13,7	37	-	29	-	27	25	298.216.0	9,1
28 - 31	3/4"	18,8	40	-	35	-	34	25	298.220.0	13,8
34 - 37	1"	23,8	45	-	42	-	40	5	298.226.0	18,8
43 - 47	1.1/4"	31,6	67	-	56	-	57	5	298.235.0	56,8
49 - 53	1.1/2"	36,8	67	-	64	-	68	1	298.240.0	84
61 - 66	2"	48	59	-	77	-	-	1	298.250.0	128

## ANAMET FITTINGS, IP 67, GALVANISED STEEL

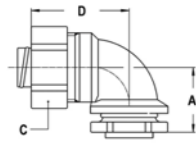

90° STN boxconnector fitting, galvanised steel



FOR HOLE MIN - MAX	SEALTITE SIZE (INCH)	MIN. INTERNAL BORE (MM)	DIMENSIONS IN MM					STANDARD PACKAGE	ARTICLE NUMBER	WEIGHT (KG/100)
			A	B	C	D	E			
22 - 25	3/8"	10,4	-	-	26	-	-	25	298.812.0	9,6
22 - 25	1/2"	13,7	-	-	29	-	-	25	298.816.0	13,8
28 - 31	3/4"	18,8	-	-	35	-	-	10	298.820.0	16,4
34 - 37	1"	23,8	-	-	42	-	-	5	298.826.0	36,4



Grounding ferrule, galvanised steel



THREAD	SEALTITE SIZE (INCH)	MIN. INTERNAL BORE (MM)	DIMENSIONS IN MM					STANDARD PACKAGE	ARTICLE NUMBER	WEIGHT (KG/100)
			A	B	C	D	E			
-	3/8"	10,4	-	-	-	-	-	50	297.212.0	1,3
-	1/2"	13,7	-	-	-	-	-	25	297.216.0	1,3
-	3/4"	18,8	-	-	-	-	-	25	297.220.0	1,4
-	1"	24,2	-	-	-	-	-	25	297.226.0	1,8
-	1.1/4"	31,6	-	-	-	-	-	5	297.235.0	2
-	1.1/2"	36,8	-	-	-	-	-	5	297.240.0	2,4
-	2"	48	-	-	-	-	-	5	297.250.0	2,8
-	2.1/2"	58,5	-	-	-	-	-	5	297.263.0	6,4
-	3"	72	-	-	-	-	-	5	297.275.0	7,2
-	4"	95	-	-	-	-	-	1	297.299.0	7,6



NPT lock nut, galvanised steel, with "tiger grip"



THREAD	SEALTITE SIZE (INCH)	MIN. INTERNAL BORE (MM)	DIMENSIONS IN MM					STANDARD PACKAGE	ARTICLE NUMBER	WEIGHT (KG/100)
			A	B	C	D	E			
NPT 1/2"	-	-	-	-	-	-	-	100	297.416.0	0,5
NPT 3/4"	-	-	-	-	-	-	-	100	297.420.0	0,8
NPT 1"	-	-	-	-	-	-	-	50	297.426.0	1,3
NPT 1.1/4"	-	-	-	-	-	-	-	50	297.435.0	1,8
NPT 1.1/2"	-	-	-	-	-	-	-	50	297.440.0	2,2
NPT 2"	-	-	-	-	-	-	-	25	297.450.0	2,8
NPT 2.1/2"	-	-	-	-	-	-	-	1	297.463.0	3,5
NPT 3"	-	-	-	-	-	-	-	1	297.475.0	5,6
NPT 4"	-	-	-	-	-	-	-	1	297.499.0	9,8



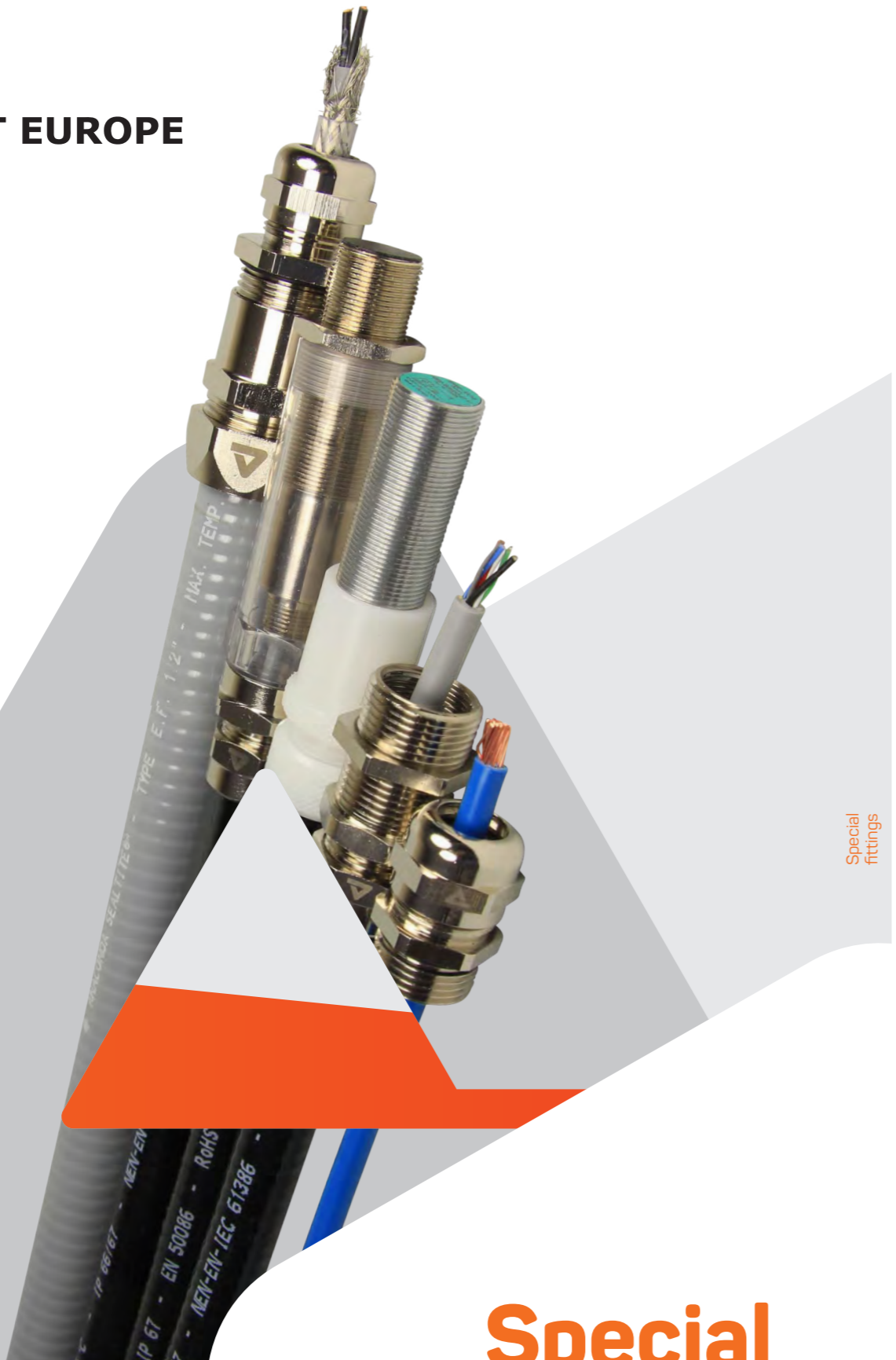

















Special fittings

# Special fittings

# Selection table Special fittings and accessories

FITTING	MATERIAL	TEMPERATURE		THREAD SIZE RANGE			SHIELDING	APPROVALS	PROTECTION	PAGE
		Min.	Max.	ISO	Pg	NPT				
Type	Housing						EMP		Class	
<b>Hummel adapter</b>	Nickel plated brass	-45 °C	+105 °C	M25 x 1 M42 x 1	Pg 11	-	+++		IP 67	6 - 3 till 6 - 4
<b>Other makes</b>	Nickel plated brass	-45 °C	+105 °C	M24 x 1	-	-	+++		IP 67	6 - 5
<b>Sensor adapter</b>	Nickel plated brass	-45 °C	+105 °C	M8 x 1 M12 x 1 M18 x 1 M30 x 1,5	-	-	+++		IP 65	6 - 6
<b>Sensor adapter</b>	Nickel plated brass / poly-carbonate	-45 °C	+105 °C	M8 x 1 M12 x 1 M18 x 1	-	-	-		IP 65	6 - 7 till 6 - 8
<b>Sensor adapter</b>	Polyamide PA6	-45 °C	+105 °C	M8 x 1 M12 x 1 M18 x 1 M30 x 1,5	-	-	-		IP 65	6 - 9
<b>Accessories</b>	Accessories for nickel plated brass fittings	-55 °C	+105 °C	-	-	-	-		-	6 - 10 till 6 - 18
<b>Accessories</b>	Accessories for stainless steel AISI-304 fittings	-55 °C	+105 °C	-	-	-	-		-	6 - 19 till 6 - 20
<b>Accessories</b>	Accessories for stainless steel AISI-316 fittings	-55 °C	+105 °C	-	-	-	-		-	6 - 21
<b>Accessories</b>	Accessories for galvanised steel fittings	-55 °C	+300 °C	-	-	-	-		-	6 - 22 till 6 - 24
<b>Pipe fittings</b>	Nickel plated brass fittings	-45 °C	+105 °C	DN16 to DN32	-	-	+++		IP 67	6 - 25
<b>Cable glands</b>	Nickel plated brass	-55 °C	+125 °C	M16 to M50	-	-	+++	 	IP 68	6 - 26
<b>Cable glands</b>	Nickel plated brass or stainless steel AISI-316	-45 °C	+105 °C	M16 to M50	-	1/2" to 1 1/2"	+++	   	IP 68	6 - 27 till 6 - 30

# Special fittings, IP 40 / 54 / 67 / 68, nickel plated brass



## ANACONDA ADAPTER FOR HUMMEL POWER CONNECTORS

This Anaconda nickel plated brass adapter has been designed specially for the Hummel power connector range. The 4 piece fitting in combination with the conduit and power connector makes a perfect fit. The design has been made in such a way that the clamping range of the power connector has been assured and that the connection on the conduit is IP 67 liquid-tight. Besides a combination with Anaconda Sealbite, also combinations with the other conduit types of the Anamet range are possible.

### Material & Construction:

**Construction:** Nickel plated brass fitting, consisting of 4 parts (counter nut, clamping ring, ferrule and body).

**Material:** Counternut, body and ferrule are nickel plated brass with exception of size 3/8" till 1" where the ferrule is from galvanised steel. Clamping ring is made from PA6.

**Temperature:** -45 °C till +105 °C continuous.

**Protection class:** Depending on the protection class of the conduit. Connection between the adapter and the power connector is IP 67 / IP 69 (Hummel specification).

**Colour:** Metal coloured.

Power connector adapter for Anaconda Sealbite, IP 67  
(for conduit details see chapters 3 and 4)



Special fittings

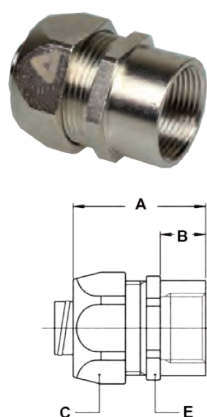

THREAD	SEALBITE SIZE (INCH)	HUMMEL RANGE	CLAMPING RANGE (MM)	DIMENSIONS IN MM			STANDARD PACKAGE	ARTICLE NUMBER	WEIGHT (KG/100)
				A	B	C			
Pg 11	5/16"	M16	2 - 7	-	-	-	10	810.303.2	4,8
Pg 11	3/8"	M16	8 - 10	-	-	-	10	810.304.1	4,8
M25 x 1	3/8"	M23	3 - 10	-	-	-	10	812.323.1	7,6
M25 x 1	1/2"	M23	7 - 13	-	-	-	10	812.327.1	7,6
M25 x 1	3/4"	M23	11 - 17	-	-	-	5	812.329.1	18,3
M42 x 1	1"	M40	13 - 23,5	-	-	-	5	812.338.1	31,8
M42 x 1	1.1/4"	M40	18 - 28	-	-	-	2	812.342.1	31,8

Power connector adapter for Multiflex type SL / SLI, IP 40  
(for conduit details see chapter 1)

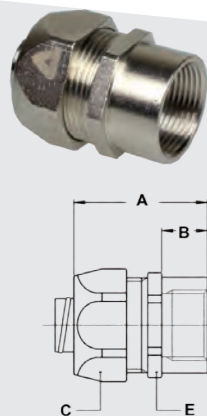

THREAD	SEALBITE SIZE (INCH)	HUMMEL RANGE	CLAMPING RANGE (MM)	DIMENSIONS IN MM			STANDARD PACKAGE	ARTICLE NUMBER	WEIGHT (KG/100)
				A	B	C			
Pg 11	5/16"	M16	2 - 7	-	-	-	10	810.303.6	4,8
Pg 11	3/8"	M16	8 - 10	-	-	-	10	810.304.6	6,6
M25 x 1	3/8"	M23	3 - 10	-	-	-	10	812.323.6	9,4
M25 x 1	1/2"	M23	7 - 13	-	-	-	10	812.327.6	9,4
M25 x 1	3/4"	M23	11 - 17	-	-	-	5	812.329.6	21,3
M42 x 1	1"	M40	13 - 23,5	-	-	-	5	812.338.6	34,8
M42 x 1	1.1/4"	M40	18 - 28	-	-	-	2	812.342.6	34,6

## SPECIAL FITTINGS, IP 40 / 54 / 67 / 68, NICKEL PLATED BRASS

Power connector adapter for Multiflex type UIG / UI, IP 40  
(for conduit details see chapter 1)

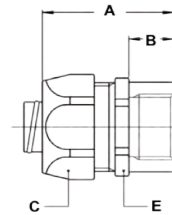

THREAD	SEALTITE SIZE (INCH)	HUMMEL RANGE	CLAMPING RANGE (MM)	DIMENSIONS IN MM			STANDARD PACKAGE	ARTICLE NUMBER	WEIGHT (KG/100)
				A	B	C			
Pg 11	5/16"	M16	2 - 7	-	-	-	10	810.303.7	6,2
Pg 11	3/8"	M16	8 - 10	-	-	-	10	810.304.7	6,4
M25 x 1	3/8"	M23	3 - 9,8	-	-	-	10	812.323.7	9,2
M25 x 1	1/2"	M23	7 - 13	-	-	-	10	812.327.7	9,4
M25 x 1	3/4"	M23	11 - 17	-	-	-	5	812.329.7	21,3
M42 x 1	1"	M40	13 - 22,8	-	-	-	5	812.338.7	34,4
M42 x 1	1.1/4"	M40	18 - 28	-	-	-	2	812.342.7	35,6

Power connector adapter for Multitite type FCD / FCE, IP 68  
(for conduit details see chapter 2)

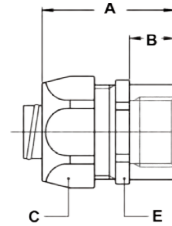

THREAD	FCD/FCE SIZE (NW)	HUMMEL RANGE	CLAMPING RANGE (MM)	DIMENSIONS IN MM			STANDARD PACKAGE	ARTICLE NUMBER	WEIGHT (KG/100)
				A	B	C			
Pg 11	12	M 16	2 - 7	-	-	-	10	810.303.2*	4,8
Pg 11	16	M 16	8 - 10	-	-	-	10	810.304.5	4,8
M 25 x 1	16	M 23	3 - 11	-	-	-	10	812.323.5	7,6
M 25 x 1	20	M 23	7 - 13	-	-	-	10	812.327.5	7,6
M 25 x 1	25	M 23	11 - 17	-	-	-	5	812.329.5	18,3

\* The Pg 11 for FCD / FCE 12 is rated IP 67 instead of IP 68.

Power connector adapter for Hiprojacket Aero, IP 54 / IP 67  
(for conduit details see chapter 10)

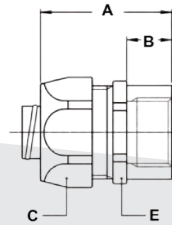

THREAD	HIPRO-JACKET SIZE (NW)	HUMMEL RANGE	CLAMPING RANGE (MM)	DIMENSIONS IN MM			STANDARD PACKAGE	ARTICLE NUMBER	WEIGHT (KG/100)
				A	B	C			
Pg 11	13	M16	8 - 10	-	-	-	10	810.304.1	4,8
M25 x 1	13	M23	3 - 10	-	-	-	10	812.323.1	7,6
M25 x 1	16	M23	7 - 13	-	-	-	10	812.327.1	7,6
M25 x 1	22	M23	11 - 17	-	-	-	5	812.329.1	18,3
M42 x 1	25	M40	13 - 23,5	-	-	-	5	812.338.1	31,8
M42 x 1	35	M40	18 - 28	-	-	-	2	812.342.1	31,8

Note: Additional clamp ring is necessary, see below. Standard protection class: IP 54, additional sealed with Hiprosiltape, IP 67 is possible.

Clamping ring, zinc plated brass, for combination with Hiprojacket Aero



HIPROJACKET AERO		HUMMEL RANGE	FITTING THREAD SIZE			STANDARD PACKAGE	ARTICLE NUMBER	WEIGHT (KG/100)
Size (mm)	Type		ISO	Pg	NPT			
13	HJ - 08	M16	-	Pg 11	-	10	817.512.0	0,6
13	HJ - 08	M23	M25 x 1	-	-	10	817.512.0	0,6
16	HJ - 10	M23	M25 x 1	-	-	10	817.516.0	0,6
22	HJ - 14	M23	M25 x 1	-	-	5	817.520.0	1
25	HJ - 16	M40	M42 x 1	-	-	5	817.526.0	1,2
35	HJ - 22	M40	M42 x 1	-	-	2	817.535.0	2,8

# Special fittings, IP 40 / 54 / 67 / 68, nickel plated brass



## ANACONDA ADAPTER FOR VARIOUS MAKES POWER CONNECTORS

This Anaconda nickel plated brass adapter has been designed for use with all brands of power connectors with the exception of a Hummel. The 4 piece fitting is designed to ensure a liquid tight IP 67 connection on Anamet Sealrite and Multitite conduits and IP 40 on a Multiflex conduit.

### Material & Construction:

**Construction:** Nickel plated brass fitting, consisting of 4 parts (counter nut, clamping ring, ferrule and body).

**Material:** Counter nut, body and ferrule are nickel plated brass with exception of size 3/8" till 1" where the ferrule is from galvanised steel. Clamping ring is made from PA6.

**Temperature:** -45 °C till +105 °C continuous.

**Protection class:** Depending on the protection class of the conduit. Connection between the adapter and the power connector is IP 67 / IP 69 (depending on makers specification).

**Colour:** Metal coloured.



Power connector adapter for Anaconda Sealrite, IP 67 (for conduit details see chapters 3 and 4)



THREAD	SEALRITE SIZE (INCH)	MAKERS RANGE	CLAMPING RANGE (MM)	DIMENSIONS IN MM			STANDARD PACKAGE	ARTICLE NUMBER	WEIGHT (KG/100)
				A	B	C			
M24 x 1	3/8"	-	3 - 10	-	-	-	10	812.322.1	7,6
M24 x 1	1/2"	-	7 - 13	-	-	-	10	812.326.1	9



Power connector adapter for Multiflex type SL / SLI, IP 40 (for conduit details see chapter 1)



THREAD	SEALRITE SIZE (INCH)	MAKERS RANGE	CLAMPING RANGE (MM)	DIMENSIONS IN MM			STANDARD PACKAGE	ARTICLE NUMBER	WEIGHT (KG/100)
				A	B	C			
M24 x 1	3/8"	-	3 - 10	-	-	-	10	812.322.6	9,4
M24 x 1	1/2"	-	7 - 13	-	-	-	10	812.326.6	9,4



Power connector adapter for Multiflex type UIG / UI, IP 40 (for conduit details see chapter 1)



THREAD	SEALRITE SIZE (INCH)	MAKERS RANGE	CLAMPING RANGE (MM)	DIMENSIONS IN MM			STANDARD PACKAGE	ARTICLE NUMBER	WEIGHT (KG/100)
				A	B	C			
M24 x 1	3/8"	-	3 - 9,8	-	-	-	10	812.322.7	9,2
M24 x 1	1/2"	-	7 - 13	-	-	-	10	812.326.7	9,4



Power connector adapter for Multitite type FCD / FCE, IP 68 (for conduit details see chapter 2)



THREAD	FCD / FCE SIZE (NW)	MAKERS RANGE	CLAMPING RANGE (MM)	DIMENSIONS IN MM			STANDARD PACKAGE	ARTICLE NUMBER	WEIGHT (KG/100)
				A	B	C			
M24 x 1	16	-	3 - 11	-	-	-	10	812.322.5	7,6
M24 x 1	20	-	7 - 13	-	-	-	10	812.326.5	9

Special fittings



# Sensor adapters, IP 65, nickel plated brass



## ANACONDA SENSOR ADAPTER IN FULL METAL FOR PEPPERL + FUCHS SENSORS

The Anaconda nickel plated brass adapter is designed for use with a sensor of the fixed wire connection type. The all metal design means it is suited for high temperature and other demanding applications - conditions where plastic adapters often fail. The Anaconda adapter accommodates a sensor at one end and an Anaconda Sealtite or Multiflex conduit at the other end, an assembly that ensures long term protection of the sensor cable. The sensor is installed into the female thread of the adapter and the conduit is installed at the other end with a locknut on the male thread of the adapter. IP 65 is achieved with an Anaconda Sealtite conduit, IP 40 with a Multiflex conduit.

### Material & Construction:

**Construction:** Nickel plated brass, consisting of 5 parts (counter nut, clamping ring, ferrule, body and locknut).

**Material:** Counter nut, ferrule, body and locknut are nickel plated brass. Clamping ring is made of Polyamide PA6.

**Temperature:** -45 °C till +105 °C continuous.

**Protection class:** IP 65.

**Colour:** Metal coloured.

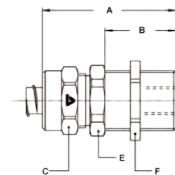

Sensor adapter for Anaconda Sealtite, IP 65  
(for conduit details see chapters 3 and 4)



FEMALE THREAD	SEALTITE SIZE (INCH)	MALE THREAD	MIN. INTERNAL BORE (MM)	DIMENSIONS IN MM						STANDARD PACKAGE	ARTICLE NUMBER	WEIGHT (KG/100)
				A	B	C	E	F				
M8 x 1	1/4"	M12 x 1,5	5,2	34	12	19	17	15	10	884.008.0	3	
M12 x 1	1/4"	M16 x 1,5	5,2	38	16	19	17	20	10	884.012.0	3,5	
M14 x 1	1/4"	M18 x 1,5	5,2	41	20	19	20	22	10	884.014.0	4	
M18 x 1	5/16"	M22 x 1,5	8,3	49	26	22	24	26	10	884.018.0	6	
M30 x 1,5	5/16"	M35 x 1,5	8,3	53	30	22	36	40	5	884.030.0	13	

# Sensor adapters, IP 40 / 65, polycarbonate



## ANACONDA ADAPTER FOR PEPPERL + FUCHS SENSORS

This adapter is made of polycarbonate and is designed for use with adapters which have an additional connection at the switch. The benefit of using polycarbonate is that the light diode is visible to the naked eye, while the switch is operating. The material is also impact and scratch resistant. The universal design of the adapter enables it to be used with most Anamet conduits. The adapter is also suitable for use with direct cable switch connectors, old and new types.

### Material & Construction:

**Construction:** Nickel plated brass fitting, consisting of 5 parts (counter nut, clamping ring, ferrule, body and holder).

**Material:** Counter nut, body and ferrule are nickel plated brass with exception of size 3/8" till 1" where the ferrule is from galvanised steel. Clamping ring is made from PA6. The holder is made from poly-carbonate and is impact and scratch resistant.

**Temperature:** -45 °C till +105 °C continuous.

**Protection class:** Depending on the protection class of the conduit. Connection between the adapter and the power connector is IP 65.

**Colour:** Metal coloured.



Sensor adapter for Anaconda Sealite, IP 65  
(for conduit details see chapters 3 and 4)



THREAD	SEALTITE SIZE (INCH)	MAKERS RANGE	MIN. INTERNAL BORE (MM)	DIMENSIONS IN MM			STANDARD PACKAGE	ARTICLE NUMBER	WEIGHT (KG/100)
				A	B	C			
M8 x 1	1/4"	-	5,2	-	-	-	10	883.308.0	3
M8 x 1	5/16"	-	8,3	-	-	-	10	883.310.0	3,4
M12 x 1	1/4"	-	5,2	-	-	-	10	883.312.0	3
M12 x 1	5/16"	-	8,3	-	-	-	10	883.316.0	3,4
M18 x 1	1/4"	-	5,2	-	-	-	10	883.314.0	3
M18 x 1	5/16"	-	8,3	-	-	-	10	883.318.0	3,4

Special fittings



Sensor adapter for Multiflex type SL / SLI, IP 40  
(for conduit details see chapter 1)



THREAD	SEALTITE SIZE (INCH)	MAKERS RANGE	MIN. INTERNAL BORE (MM)	DIMENSIONS IN MM			STANDARD PACKAGE	ARTICLE NUMBER	WEIGHT (KG/100)
				A	B	C			
M8 x 1	1/4"	-	5,2	-	-	-	10	883.308.6	3,4
M8 x 1	5/16"	-	8,3	-	-	-	10	883.310.6	4
M12 x 1	1/4"	-	5,2	-	-	-	10	883.312.6	3,4
M12 x 1	5/16"	-	8,3	-	-	-	10	883.316.6	4
M18 x 1	1/4"	-	5,2	-	-	-	10	883.314.6	3,4
M18 x 1	5/16"	-	8,3	-	-	-	10	883.318.6	4

## SENSOR ADAPTERS, IP 40 / 65, POLYCARBONATE



Sensor adapter for Multiflex type UI-CAP, IP 40  
(for conduit details see chapter 1)



THREAD	UI-CAP SIZE (NW)	MAKERS RANGE	MIN. INTERNAL BORE (MM)	DIMENSIONS IN MM			STANDARD PACKAGE	ARTICLE NUMBER	WEIGHT (KG/100)
				A	B	C			
M8 x 1	6	-	5,2	-	-	-	10	883.308.7	3,4
M8 x 1	9,5	-	8	-	-	-	10	883.310.7	4
M12 x 1	6	-	5,2	-	-	-	10	883.312.7	3,4
M12 x 1	9,5	-	8	-	-	-	10	883.316.7	4
M18 x 1	6	-	5,2	-	-	-	10	883.314.7	3,4
M18 x 1	9,5	-	8	-	-	-	10	883.318.7	4



Sensor adapter for Multitite type FCD / FCE, IP 65  
(for conduit details see chapter 2)



THREAD	FCD / FCE SIZE (NW)	MAKERS RANGE	MIN. INTERNAL BORE (MM)	DIMENSIONS IN MM			STANDARD PACKAGE	ARTICLE NUMBER	WEIGHT (KG/100)
				A	B	C			
M8 x 1	12	-	8,3	-	-	-	10	883.310.0	3
M12 x 1	12	-	8,3	-	-	-	10	883.316.0	3
M18 x 1	12	-	8,3	-	-	-	10	883.318.0	3

# Sensor adapters, IP 65, polyamide



## ADAPTER FOR MULTI BRANDS OF OLDER GENERATION FIXED WIRE SENSORS

The adapter is designed to connect an old generation fixed wire sensor at one end and an Anaconda Sealbite conduit at the other end. Combinations with other conduit types are not possible.

### Material & Construction:

**Construction:** Polyamide fitting, consisting of 4 parts (counter nut, clamping ring, ferrule, and body).

**Material:** Counter nut, body and clamping ring are PA6. Ferrule is made of brass.

**Temperature:** -45 °C till +105 °C continuous.

**Protection class:** IP 65 (dust-proof, water-protected).

**Colour:** White.

Sensor adapter for Anaconda Sealbite, IP 65  
(for conduit details see chapters 3 and 4)



Special fittings



THREAD	SEALBITE SIZE (INCH)	MAKERS RANGE	MIN. INTERNAL BORE (MM)	DIMENSIONS IN MM			STANDARD PACKAGE	ARTICLE NUMBER	WEIGHT (KG/100)
				A	B	C			
M8 x 1	1/4"	-	5,2	-	-	-	25	883.208.0	0,8
M12 x 1	5/16"	-	8,3	-	-	-	25	883.212.0	1,2
M18 x 1	5/16"	-	8,3	-	-	-	25	883.218.0	1,4
M30 x 1,5	5/16"	-	8,3	-	-	-	25	883.230.0	2,8
ID 20 mm	5/16"	-	8,3	-	-	-	25	883.320.0	2
ID 34 mm	5/16"	-	8,3	-	-	-	25	883.334.0	3

## ACCESSORIES FOR NICKEL PLATED BRASS FITTINGS



Flanged grounding ferrule, galvanised steel



THREAD	SEALTITE SIZE (INCH)	MIN. INTERNAL BORE (MM)	DIMENSIONS IN MM					STANDARD PACKAGE	ARTICLE NUMBER	WEIGHT (KG/100)
			A	B	C	D	E			
-	3/8"	11	-	-	-	-	-	50	815.011.2	0,4
-	1/2"	14,5	-	-	-	-	-	50	815.016.2	0,5
-	3/4"	19,4	-	-	-	-	-	25	815.021.2	0,7
-	1"	24,7	-	-	-	-	-	25	815.029.2	1,1
-	1.1/4"	33,3	-	-	-	-	-	10	815.036.2	1,5
-	1.1/2"	38	-	-	-	-	-	10	815.042.2	2,1
-	2"	49	-	-	-	-	-	10	815.048.2	3,2
-	2.1/2"	60,7	-	-	-	-	-	5	815.063.2	4,3
-	3"	75,5	-	-	-	-	-	5	815.075.2	5,9



Grounding ferrule, galvanised steel



THREAD	SEALTITE SIZE (INCH)	MIN. INTERNAL BORE (MM)	DIMENSIONS IN MM					STANDARD PACKAGE	ARTICLE NUMBER	WEIGHT (KG/100)
			A	B	C	D	E			
-	3/8"	10,2	-	-	-	-	-	10	815.011.0	0,4
-	1/2"	13,9	-	-	-	-	-	10	815.016.0	0,6
-	3/4"	18,5	-	-	-	-	-	5	815.021.0	0,8
-	1"	23,8	-	-	-	-	-	5	815.029.0	1,4



Grounding ferrule, nickel plated brass



THREAD	SEALTITE SIZE (INCH)	MIN. INTERNAL BORE (MM)	DIMENSIONS IN MM					STANDARD PACKAGE	ARTICLE NUMBER	WEIGHT (KG/100)
			A	B	C	D	E			
-	1/4"	5,2	-	-	-	-	-	10	815.006.0	0,4
-	5/16"	8,3	-	-	-	-	-	10	815.010.0	0,8
-	3/8"	10,2	-	-	-	-	-	10	815.011.3	0,6
-	1/2"	13,9	-	-	-	-	-	10	815.016.3	0,8
-	3/4"	18,5	-	-	-	-	-	5	815.021.3	1,4
-	1"	23,8	-	-	-	-	-	5	815.029.3	2,8
-	1.1/4"	31,8	-	-	-	-	-	2	815.036.3	6
-	1.1/2"	36,8	-	-	-	-	-	2	815.042.3	6,8
-	2"	47,8	-	-	-	-	-	2	815.048.3	8,8

## ACCESSORIES FOR NICKEL PLATED BRASS FITTINGS



Neoprene sealing gasket for ISO



THREAD ISO	THREAD PG	THREAD NPT	DIMENSIONS IN MM					STANDARD PACKAGE	ARTICLE NUMBER	WEIGHT (KG/100)
			A	B	C	D	E			
M16 x 1,5	-	-	1,2	-	20	14	-	100	815.416.0	0,03
M20 x 1,5	-	-	1,2	-	24	18	-	100	815.420.0	0,03
M25 x 1,5	-	-	1,2	-	30	23	-	50	815.425.0	0,05
M32 x 1,5	-	-	1,2	-	40	30	-	50	815.432.0	0,11
M40 x 1,5	-	-	1,2	-	48	38	-	50	815.440.0	0,15
M50 x 1,5	-	-	1,2	-	58	48	-	50	815.450.0	0,19
M63 x 1,5	-	-	1,2	-	75	61	-	50	815.463.0	0,33



Neoprene sealing gasket for Pg / NPT



THREAD ISO	THREAD PG	THREAD NPT	DIMENSIONS IN MM					STANDARD PACKAGE	ARTICLE NUMBER	WEIGHT (KG/100)
			A	B	C	D	E			
-	Pg 7	-	1,2	-	17	11,5	-	100	815.507.0	0,03
-	Pg 9	-	1,2	-	20	14	-	100	815.509.0	0,03
-	Pg 11	-	1,2	-	23	17	-	100	815.511.0	0,03
-	Pg 13,5	-	1,2	-	25	19	-	100	815.513.0	0,04
-	Pg 16	NPT 1/2"	1,2	-	27	21	-	100	815.516.0	0,05
-	Pg 21	NPT 3/4"	1,2	-	34	26,5	-	50	815.521.0	0,07
-	Pg 29	NPT 1"	1,2	-	45	35	-	50	815.529.0	0,13
-	Pg 36	NPT 1.1/4"	1,2	-	56	45	-	50	815.536.0	0,19
-	Pg 42	NPT 1.1/2"	1,2	-	67	52	-	50	815.542.0	0,3
-	Pg 48	NPT 2"	1,2	-	72	58	-	50	815.548.0	0,34

Special fittings



NBR sealing gasket for NPT



THREAD	SEALTITE SIZE (INCH)	MIN. INTERNAL BORE (MM)	DIMENSIONS IN MM					STANDARD PACKAGE	ARTICLE NUMBER	WEIGHT (KG/100)
			A	B	C	D	E			
NPT 1/2"	1/2"	-	-	-	-	-	-	50	815.616.0	0,03
NPT 3/4"	3/4"	-	-	-	-	-	-	25	815.620.0	0,05
NPT 1"	1"	-	-	-	-	-	-	25	815.626.0	0,11
NPT 1.1/4"	1.1/4"	-	-	-	-	-	-	10	815.635.0	0,15
NPT 1.1/2"	1.1/2"	-	-	-	-	-	-	10	815.640.0	0,19
NPT 2"	2"	-	-	-	-	-	-	10	815.650.0	0,33
NPT 2.1/2"	2.1/2"	-	-	-	-	-	-	10	815.663.0	0,45
NPT 3"	3"	-	-	-	-	-	-	10	815.675.0	0,6



## ACCESSORIES FOR NICKEL PLATED BRASS FITTINGS

### ISO lock nuts, nickel plated brass



THREAD	SEALTITE SIZE (INCH)	MIN. INTERNAL BORE (MM)	DIMENSIONS IN MM					STANDARD PACKAGE	ARTICLE NUMBER	WEIGHT (KG/100)
			A	B	C	D	E			
M16 x 1,5	-	-	3	-	20	-	-	50	880.116.0	0,4
M20 x 1,5	-	-	3,5	-	24	-	-	50	880.120.0	0,6
M25 x 1,5	-	-	3,5	-	30	-	-	25	880.125.0	0,9
M32 x 1,5	-	-	4,5	-	35	-	-	20	880.132.0	2,2
M40 x 1,5	-	-	4,5	-	45	-	-	10	880.140.0	3,2
M50 x 1,5	-	-	5,5	-	55	-	-	10	880.150.0	5
M63 x 1,5	-	-	6	-	70	-	-	5	880.163.0	5,6
M75 x 1,5	-	-	7	-	80	-	-	5	880.175.0	7,5
M90 x 2,0	-	-	8	-	100	-	-	5	880.190.0	11

### Pg lock nuts, nickel plated brass



THREAD	SEALTITE SIZE (INCH)	MIN. INTERNAL BORE (MM)	DIMENSIONS IN MM					STANDARD PACKAGE	ARTICLE NUMBER	WEIGHT (KG/100)
			A	B	C	D	E			
Pg 7	-	-	2,9	-	15	-	-	50	880.007.0	0,2
Pg 9	-	-	2,9	-	18	-	-	50	880.009.0	0,2
Pg 11	-	-	2,9	-	21	-	-	50	880.011.0	0,3
Pg 13,5	-	-	3,1	-	23	-	-	50	880.013.0	0,4
Pg 16	-	-	3,1	-	26	-	-	50	880.016.0	0,5
Pg 21	-	-	3,6	-	32	-	-	20	880.021.0	0,8
Pg 29	-	-	4,1	-	41	-	-	20	880.029.0	1,4
Pg 36	-	-	5,1	-	51	-	-	10	880.036.0	2,1
Pg 42	-	-	5,1	-	60	-	-	5	880.042.0	3,6
Pg 48	-	-	5,6	-	64	-	-	5	880.048.0	4,1

### NPT lock nuts, nickel plated brass



THREAD	SEALTITE SIZE (INCH)	MIN. INTERNAL BORE (MM)	DIMENSIONS IN MM					STANDARD PACKAGE	ARTICLE NUMBER	WEIGHT (KG/100)
			A	B	C	D	E			
NPT 1/2"	-	-	4	-	27	-	-	50	880.216.0	1,1
NPT 3/4"	-	-	4,5	-	32	-	-	25	880.220.0	1,4
NPT 1"	-	-	6	-	38	-	-	25	880.226.0	2,1
NPT 1.1/4"	-	-	6,5	-	48	-	-	5	880.235.0	3,5
NPT 1.1/2"	-	-	7	-	55	-	-	5	880.240.0	5
NPT 2"	-	-	7,5	-	70	-	-	5	880.250.0	8,8

## ACCESSORIES FOR NICKEL PLATED BRASS FITTINGS



NPT "tiger grip" locknut, galvanised steel



THREAD	SEALTITE SIZE	MIN. INTERNAL BORE (MM)	DIMENSIONS IN MM					STANDARD PACKAGE	ARTICLE NUMBER	WEIGHT (KG/100)
			A	B	C	D	E			
NPT 1/2"	-	-	-	-	-	-	-	100	880.316.0	0,5
NPT 3/4"	-	-	-	-	-	-	-	50	880.320.0	0,8
NPT 1"	-	-	-	-	-	-	-	50	880.326.0	1,3
NPT 1.1/4"	-	-	-	-	-	-	-	20	880.335.0	1,8
NPT 1.1/2"	-	-	-	-	-	-	-	20	880.340.0	2,2
NPT 2"	-	-	-	-	-	-	-	20	880.350.0	2,8
NPT 2.1/2"	-	-	-	-	-	-	-	10	880.363.0	3,5
NPT 3"	-	-	-	-	-	-	-	10	880.375.0	5,6



Pg / Pg enlargers, nickel plated brass



THREAD	THREAD	MIN. INTERNAL BORE (MM)	DIMENSIONS IN MM					STANDARD PACKAGE	ARTICLE NUMBER	WEIGHT (KG/100)
			A	B	C	D	E			
Pg 7	Pg 9	-	15	5	17	-	-	50	882.009.0	0,7
Pg 9	Pg 11	-	16,5	6	20	-	-	50	882.011.0	0,9
Pg 9	Pg 13,5	-	17,5	6	22	-	-	50	882.012.0	1,1
Pg 11	Pg 13,5	-	17,5	6	22	-	-	50	882.013.0	1,2
Pg 11	Pg 16	-	19	6,5	24	-	-	25	882.016.0	1,2
Pg 13,5	Pg 16	-	18,5	6	24	-	-	25	882.017.0	1,3
Pg 13,5	Pg 21	-	21	6,5	30	-	-	20	882.018.0	2,3
Pg 16	Pg 21	-	21	6,5	30	-	-	20	882.021.0	2,4
Pg 21	Pg 29	-	23	7	39	-	-	15	882.029.0	3,7
Pg 29	Pg 36	-	28	8	50	-	-	10	882.036.0	7,4
Pg 36	Pg 42	-	31	9	57	-	-	10	882.042.0	9,3
Pg 42	Pg 48	-	33	10	64	-	-	10	882.048.0	14,7

Special fittings



Pg / ISO adapter, nickel plated brass



THREAD	THREAD	SHAPE	DIMENSIONS IN MM					STANDARD PACKAGE	ARTICLE NUMBER	WEIGHT (KG/100)
			A	B	C	D	E			
Pg 11	M16 x 1,5	A	11	6,5	22	-	-	50	882.111.0	1,3
Pg 16	M20 x 1,5	A	16	7	27	-	-	50	882.116.0	3,2
Pg 21	M25 x 1,5	B	13	8	32	-	-	20	882.121.0	3,8
Pg 29	M32 x 1,5	B	14	8,5	40	-	-	20	882.129.0	8
Pg 36	M40 x 1,5	B	15	8,5	55	-	-	10	882.136.0	12,4
Pg 48	M50 x 1,5	B	17	10	65	-	-	5	882.148.0	17,2

## ACCESSORIES FOR NICKEL PLATED BRASS FITTINGS

### Pg / Pg reducers, nickel plated brass



OUTSIDE THREAD	INSIDE THREAD	MIN. INTERNAL BORE (MM)	DIMENSIONS IN MM					STANDARD PACKAGE	ARTICLE NUMBER	WEIGHT (KG/100)
			A	B	C	D	E			
Pg 9	Pg 7	-	8	5	17	-	-	100	881.007.0	0,4
Pg 11	Pg 7	-	9	6	19	-	-	100	881.008.0	0,7
Pg 11	Pg 9	-	9	6	19	-	-	100	881.009.0	0,9
Pg 13,5	Pg 9	-	9	6	21	-	-	100	881.010.0	0,9
Pg 13,5	Pg 11	-	9	6	21	-	-	100	881.011.0	0,9
Pg 16	Pg 11	-	9	6	23	-	-	100	881.012.0	0,9
Pg 16	Pg 13,5	-	9	6	23	-	-	100	881.013.0	1,2
Pg 21	Pg 13,5	-	10	7	29	-	-	50	881.015.0	2,1
Pg 21	Pg 16	-	10	7	29	-	-	50	881.016.0	1,8
Pg 29	Pg 21	-	11	8	39	-	-	25	881.021.0	3,7
Pg 36	Pg 29	-	11	8	50	-	-	25	881.029.0	5,7
Pg 42	Pg 36	-	14	10	64	-	-	25	881.036.0	6,5
Pg 48	Pg 42	-	14	10	64	-	-	25	881.042.0	7,7

### ISO / ISO enlarger, nickel plated brass

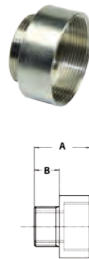

THREAD	INSIDE THREAD	MIN. INTERNAL BORE (MM)	DIMENSIONS IN MM					STANDARD PACKAGE	ARTICLE NUMBER	WEIGHT (KG/100)
			A	B	C	D	E			
M12 x 1,5	M16 x 1,5	-	15	5	18	-	-	50	881.216.0	1,2
M16 x 1,5	M20 x 1,5	-	18	6	22	-	-	50	881.220.0	1,5
M20 x 1,5	M25 x 1,5	-	19	7	27	-	-	50	881.225.0	2,5
M25 x 1,5	M32 x 1,5	-	21	8	34	-	-	20	881.232.0	2,9
M32 x 1,5	M40 x 1,5	-	23	8	42	-	-	20	881.240.0	4,5
M32 x 1,5	M50 x 1,5	-	31	9	53	-	-	10	881.245.0	6
M40 x 1,5	M50 x 1,5	-	31	9	53	-	-	10	881.250.0	7,7
M50 x 1,5	M63 x 1,5	-	24	10	65	-	-	5	881.263.0	7,8

### ISO / Pg adapter, nickel plated brass

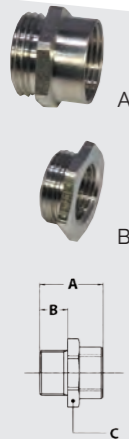

THREAD	INSIDE THREAD	SHAPE	DIMENSIONS IN MM					STANDARD PACKAGE	ARTICLE NUMBER	WEIGHT (KG/100)
			A	B	C	D	E			
M12 x 1,5	Pg 7	A	17	7	14	-	-	100	881.107.0	0,8
M16 x 1,5	Pg 9	A	18	7	18	-	-	50	881.109.0	0,9
M20 x 1,5	Pg 11	A	18	7	22	-	-	50	881.111.0	1,6
M25 x 1,5	Pg 16	A	22	8	27	-	-	50	881.116.0	2,6
M32 x 1,5	Pg 21	A	24	9	34	-	-	20	881.121.0	4
M40 x 1,5	Pg 29	B	14	9	42	-	-	10	881.129.0	8,6
M50 x 1,5	Pg 36	B	16	10	52	-	-	10	881.136.0	12,3
M63 x 1,5	Pg 48	A	33	11	65	-	-	1	881.148.0	22,5

## ACCESSORIES FOR NICKEL PLATED BRASS FITTINGS



ISO / ISO reducer, nickel plated brass

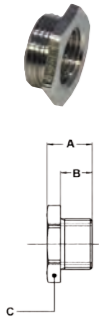

OUTSIDE THREAD	INSIDE THREAD	MIN. INTERNAL BORE (MM)	DIMENSIONS IN MM					STANDARD PACKAGE	ARTICLE NUMBER	WEIGHT (KG/100)
			A	B	C	D	E			
M16 x 1,5	M12 x 1,5	-	10	7	20	-	-	50	882.212.0	1,2
M20 x 1,5	M16 x 1,5	-	10	7	24	-	-	50	882.216.0	1,5
M25 x 1,5	M20 x 1,5	-	12	8	30	-	-	20	882.220.0	2,6
M32 x 1,5	M25 x 1,5	-	13	9	36	-	-	20	882.225.0	4,5
M40 x 1,5	M32 x 1,5	-	13	9	42	-	-	10	882.232.0	6,9
M50 x 1,5	M40 x 1,5	-	15	10	55	-	-	5	882.240.0	11,8
M63 x 1,5	M50 x 1,5	-	18	11	70	-	-	1	882.250.0	22,1



NPT / Pg adapter, nickel plated brass

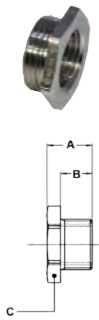

OUTSIDE THREAD	INSIDE THREAD	MIN. INTERNAL BORE (MM)	DIMENSIONS IN MM					STANDARD PACKAGE	ARTICLE NUMBER	WEIGHT (KG/100)
			A	B	C	D	E			
NPT 1/2"	Pg 9	-	-	-	-	-	-	50	882.309.0	2,9
NPT 1/2"	Pg 11	-	-	-	-	-	-	50	882.311.0	2,9
NPT 1/2"	Pg 13,5	-	-	-	-	-	-	50	882.313.0	3,2
NPT 1/2"	Pg 16	-	-	-	-	-	-	50	882.316.0	3,3
NPT 3/4"	Pg 21	-	-	-	-	-	-	50	882.321.0	8
NPT 1"	Pg 21	-	-	-	-	-	-	20	882.326.0	11,6
NPT 1"	Pg 29	-	-	-	-	-	-	20	882.329.0	13,8
NPT 1.1/4"	Pg 29	-	-	-	-	-	-	20	882.330.0	20,2
NPT 1.1/4"	Pg 36	-	-	-	-	-	-	10	882.336.0	22,3
NPT 1.1/2"	Pg 36	-	-	-	-	-	-	10	882.340.0	22,5
NPT 1.1/2"	Pg 42	-	-	-	-	-	-	5	882.342.0	23,8
NPT 2"	Pg 48	-	-	-	-	-	-	5	882.348.0	24,1

Special fittings



Pg / NPT adapter, nickel plated brass

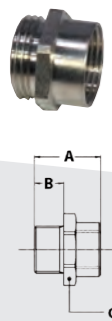

OUTSIDE THREAD	INSIDE THREAD	MIN. INTERNAL BORE (MM)	DIMENSIONS IN MM					STANDARD PACKAGE	ARTICLE NUMBER	WEIGHT (KG/100)
			A	B	C	D	E			
Pg 9	NPT 1/2"	-	-	-	-	-	-	50	882.410.0	3,1
Pg 11	NPT 3/8"	-	-	-	-	-	-	50	882.411.0	3,1
Pg 11	NPT 1/2"	-	-	-	-	-	-	50	882.412.0	2,8
Pg 13,5	NPT 1/2"	-	-	-	-	-	-	50	882.413.0	2,8
Pg 16	NPT 1/2"	-	-	-	-	-	-	50	882.416.0	3,8
Pg 21	NPT 3/4"	-	-	-	-	-	-	20	882.420.0	3,8
Pg 29	NPT 1.1/4"	-	-	-	-	-	-	20	882.435.0	8
Pg 36	NPT 1.1/2"	-	-	-	-	-	-	10	882.440.0	17
Pg 48	NPT 2"	-	-	-	-	-	-	5	882.450.0	22

## ACCESSORIES FOR NICKEL PLATED BRASS FITTINGS

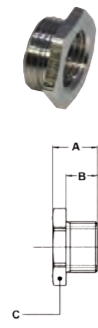

NPT / ISO adapter, nickel plated brass



OUTSIDE THREAD	INSIDE THREAD	MIN. INTERNAL BORE (MM)	DIMENSIONS IN MM					STANDARD PACKAGE	ARTICLE NUMBER	WEIGHT (KG/100)
			A	B	C	D	E			
NPT 1/2"	M16 x 1,5	-	-	-	-	-	-	50	882.516.0	3,1
NPT 1/2"	M20 x 1,5	-	-	-	-	-	-	50	882.520.0	3,2
NPT 1/2"	M25 x 1,5	-	-	-	-	-	-	50	882.522.0	2,8
NPT 1/2"	M32 x 1,5	-	-	-	-	-	-	50	882.523.0	3,5
NPT 3/4"	M20 x 1,5	-	-	-	-	-	-	50	882.524.0	4,7
NPT 3/4"	M25 x 1,5	-	-	-	-	-	-	50	882.525.0	8,9
NPT 3/4"	M32 x 1,5	-	-	-	-	-	-	10	882.527.0	9
NPT 1"	M25 x 1,5	-	-	-	-	-	-	20	882.528.0	9,2
NPT 1"	M32 x 1,5	-	-	-	-	-	-	20	882.532.0	12
NPT 1.1/4"	M25 x 1,5	-	-	-	-	-	-	20	882.536.0	20
NPT 1.1/4"	M32 x 1,5	-	-	-	-	-	-	10	882.538.0	22
NPT 1.1/4"	M40 x 1,5	-	-	-	-	-	-	20	882.540.0	28
NPT 1.1/2"	M40 x 1,5	-	-	-	-	-	-	1	882.548.0	36
NPT 1.1/2"	M50 x 1,5	-	-	-	-	-	-	1	882.550.0	40
NPT 1.1/2"	M63 x 1,5	-	-	-	-	-	-	1	882.552.0	44
NPT 2"	M50 x 1,5	-	-	-	-	-	-	1	882.560.0	-
NPT 2"	M63 x 1,5	-	-	-	-	-	-	1	882.563.0	-

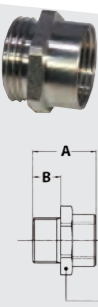

ISO / NPT adapter, nickel plated brass



OUTSIDE THREAD	INSIDE THREAD	MIN. INTERNAL BORE (MM)	DIMENSIONS IN MM					STANDARD PACKAGE	ARTICLE NUMBER	WEIGHT (KG/100)
			A	B	C	D	E			
M16 x 1,5	NPT 1/2"	-	-	-	-	-	-	50	882.612.0	3,8
M20 x 1,5	NPT 1/2"	-	-	-	-	-	-	50	882.616.0	8,9
M25 x 1,5	NPT 3/4"	-	-	-	-	-	-	20	882.620.0	7,3
M32 x 1,5	NPT 1"	-	-	-	-	-	-	10	882.626.0	7,5

## ACCESSORIES FOR NICKEL PLATED BRASS FITTINGS

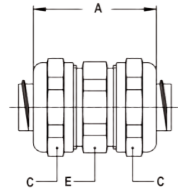

Conduit connector, nickel plated brass, IP 67



SEALTITE SIZE (INCH)	SEALTITE SIZE (INCH)	MIN. INTERNAL BORE (MM)	DIMENSIONS IN MM					STANDARD PACKAGE	ARTICLE NUMBER	WEIGHT (KG/100)
			A	B	C	D	E			
5/16"	5/16"	8,3	41	-	26	-	24	10	784.010.0	7,4
3/8"	3/8"	10,4	41	-	26	-	24	10	784.012.0	7,4
1/2"	1/2"	13,8	45	-	29	-	27	10	784.016.0	8,8
3/4"	3/4"	18,5	48	-	35	-	33	5	784.020.0	13
1"	1"	23,8	53	-	45	-	44	5	784.026.0	25,2
1.1/4"	1.1/4"	31,9	58	-	53	-	50	2	784.035.0	32,6
1.1/2"	1.1/2"	36,9	69	-	62	-	58	2	784.040.0	52,4
2"	2"	47,9	78	-	76	-	72	2	784.050.0	76,3

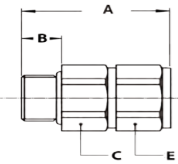

Swivel adapter, ISO, inside / outside thread, nickel plated brass, IP 54



OUTSIDE THREAD	INSIDE THREAD	MIN. INTERNAL BORE (MM)	DIMENSIONS IN MM					STANDARD PACKAGE	ARTICLE NUMBER	WEIGHT (KG/100)
			A	B	C	D	E			
M16 x 1,5	M16 x 1,5	8,5	39	10	21	-	21	10	885.216.0	6,2
M20 x 1,5	M20 x 1,5	12	42	10	25	-	25	10	885.220.0	9,2
M25 x 1,5	M25 x 1,5	17,5	42	10	31	-	31	5	885.225.0	11,2
M32 x 1,5	M32 x 1,5	22,5	45	12	38	-	38	5	885.232.0	17,2
M40 x 1,5	M40 x 1,5	28	54	14	48	-	48	2	885.240.0	36,8

Special fittings

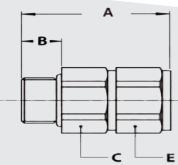

Swivel adapter, ISO, inside / outside thread, nickel plated brass, IP 67



OUTSIDE THREAD	INSIDE THREAD	MIN. INTERNAL BORE (MM)	DIMENSIONS IN MM					STANDARD PACKAGE	ARTICLE NUMBER	WEIGHT (KG/100)
			A	B	C	D	E			
M16 x 1,5	M16 x 1,5	10,4	42	12	22	-	22	10	885.216.1	6,8
M20 x 1,5	M20 x 1,5	13,9	44	13	27	-	27	10	885.220.1	10,2
M25 x 1,5	M25 x 1,5	17,4	48	15	33	-	33	5	885.225.1	16
M32 x 1,5	M32 x 1,5	23,4	48	15	40	-	40	5	885.232.1	21
M40 x 1,5	M40 x 1,5	29,4	51	16	48	-	48	2	885.240.1	30,8



## ACCESSORIES FOR NICKEL PLATED BRASS FITTINGS

90° elbow, ISO, inside / outside thread, nickel plated brass

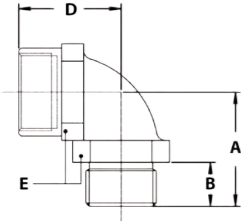

OUTSIDE THREAD	INSIDE THREAD	MIN. INTERNAL BORE (MM)	DIMENSIONS IN MM					STANDARD PACKAGE	ARTICLE NUMBER	WEIGHT (KG/100)
			A	B	C	D	E			
M16 x 1,5	M16 x 1,5	-	26	10	-	24	22	10	783.016.0	6
M20 x 1,5	M20 x 1,5	-	26	10	-	25	24	10	783.020.0	10
M25 x 1,5	M25 x 1,5	-	32	10	-	34	33	5	783.025.0	16
M32 x 1,5	M32 x 1,5	-	40	12	-	40	42	5	783.032.0	26

Neoprene, end cap, with strain relief, IP 54



THREAD	SEALTITE SIZE (INCH)	CLAMPING RANGE (MM)	DIMENSIONS IN MM					STANDARD PACKAGE	ARTICLE NUMBER	WEIGHT (KG/100)
			A	B	C	D	E			
-	3/8"	4 - 9	33	-	-	-	-	3000	266.812.0	0,3
-	1/2"	5 - 12	34	-	-	-	-	2400	266.817.0	0,6
-	3/4"	7 - 17	47	-	-	-	-	1200	266.823.0	1,1
-	1"	9 - 20	48	-	-	-	-	800	266.829.0	1,4
-	1.1/4"	16 - 30	47	-	-	-	-	800	266.836.0	1,9

Earth tags, nickel plated brass for ISO / NPT

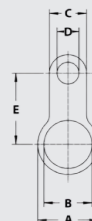

THREAD ISO	THREAD PG	THREAD NPT	DIMENSIONS IN MM					STANDARD PACKAGE	ARTICLE NUMBER	WEIGHT (KG/100)
			A	B	C	D	E			
M16 x 1,5	-	-	25	16	13	6,2	30	50	880.610.0	-
M20 x 1,5	-	-	29	20	13	6,2	33	50	880.612.0	-
M25 x 1,5	-	-	34	25	13	6,2	36	50	880.613.0	-
M32 x 1,5	-	-	42	32	22	12,2	41	50	880.620.0	-
M40 x 1,5	-	-	54	40	26	14,2	47	50	880.627.0	-
M50 x 1,5	-	-	67	50	29	14,2	64	50	880.635.0	-
M63 x 1,5	-	-	77	63	29	14,2	73	50	880.650.0	-
-	-	NPT 1/2"	29	22	13	6,2	33	50	880.716.0	-
-	-	NPT 3/4"	34	27	13	6,2	36	50	880.720.0	-
-	-	NPT 1"	42	34	22	12,2	41	50	880.726.0	-
-	-	NPT 1.1/4"	54	42	26	14,2	47	50	880.735.0	-
-	-	NPT 1.1/2"	67	49	29	14,2	64	50	880.740.0	-
-	-	NPT 2"	77	61	29	14,2	73	50	880.750.0	-

## ACCESSORIES FOR STAINLESS STEEL FITTINGS



Flanged grounding ferrule, stainless steel AISI-304



THREAD	SEALTITE SIZE (INCH)	MIN. INTERNAL BORE (MM)	DIMENSIONS IN MM					STANDARD PACKAGE	ARTICLE NUMBER	WEIGHT (KG/100)
			A	B	C	D	E			
-	3/8"	11	-	-	-	-	-	50	815.011.5	0,4
-	1/2"	14,5	-	-	-	-	-	50	815.016.5	0,5
-	3/4"	19,4	-	-	-	-	-	25	815.021.5	0,7
-	1"	24,7	-	-	-	-	-	25	815.029.5	1,1
-	1.1/4"	33,3	-	-	-	-	-	10	815.036.5	1,5
-	1.1/2"	38	-	-	-	-	-	10	815.042.5	2,1
-	2"	49	-	-	-	-	-	10	815.048.5	3,2
-	2.1/2"	60,7	-	-	-	-	-	5	815.063.5	4,3
-	3"	75,5	-	-	-	-	-	5	815.075.5	5,9



ISO lock nuts, stainless steel AISI-304



THREAD	SEALTITE SIZE (INCH)	MIN. INTERNAL BORE (MM)	DIMENSIONS IN MM					STANDARD PACKAGE	ARTICLE NUMBER	WEIGHT (KG/100)
			A	B	C	D	E			
M16 x 1,5	-	-	3,2	-	20	-	-	50	880.116.9	0,5
M20 x 1,5	-	-	3,6	-	24	-	-	50	880.120.9	0,7
M25 x 1,5	-	-	3,6	-	29	-	-	25	880.125.9	1,1
M32 x 1,5	-	-	4,6	-	35	-	-	25	880.132.9	2,4
M40 x 1,5	-	-	5	-	46	-	-	5	880.140.9	3,6
M50 x 1,5	-	-	5	-	60	-	-	5	880.150.9	5,4
M63 x 1,5	-	-	6	-	70	-	-	5	880.163.9	6,2

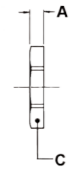

Special fittings



Pg lock nuts, stainless steel AISI-304



THREAD	SEALTITE SIZE (INCH)	MIN. INTERNAL BORE (MM)	DIMENSIONS IN MM					STANDARD PACKAGE	ARTICLE NUMBER	WEIGHT (KG/100)
			A	B	C	D	E			
Pg 11	-	-	2,9	-	21	-	-	50	880.011.9	0,4
Pg 13,5	-	-	2,9	-	23	-	-	50	880.013.9	0,5
Pg 16	-	-	3,1	-	26	-	-	25	880.016.9	0,6
Pg 21	-	-	3,6	-	32	-	-	20	880.021.9	1
Pg 29	-	-	4,1	-	41	-	-	10	880.029.9	1,6
Pg 36	-	-	5,1	-	51	-	-	10	880.036.9	2,5



NPT lock nuts, stainless steel AISI-304



THREAD	SEALTITE SIZE (INCH)	MIN. INTERNAL BORE (MM)	DIMENSIONS IN MM					STANDARD PACKAGE	ARTICLE NUMBER	WEIGHT (KG/100)
			A	B	C	D	E			
NPT 1/2"	-	-	4	-	27	-	-	50	880.216.9	1,1
NPT 3/4"	-	-	4,5	-	32	-	-	25	880.220.9	1,4
NPT 1"	-	-	6	-	38	-	-	25	880.226.9	2,1
NPT 1.1/4"	-	-	6,5	-	48	-	-	5	880.235.9	3,5
NPT 1.1/2"	-	-	7	-	55	-	-	5	880.240.9	5
NPT 2"	-	-	7,5	-	70	-	-	5	880.250.9	8,8
NPT 2.1/2"	-	-	-	-	-	-	-	1	880.263.9	-
NPT 3"	-	-	-	-	-	-	-	1	880.275.9	-



## ACCESSORIES FOR STAINLESS STEEL FITTINGS



NPT "tiger grip" locknut, stainless steel AISI-304



THREAD	SEALTITE SIZE (INCH)	MIN. INTERNAL BORE (MM)	DIMENSIONS IN MM					STANDARD PACKAGE	ARTICLE NUMBER	WEIGHT (KG/100)
			A	B	C	D	E			
NPT 1/2"	-	-	-	-	-	-	-	100	880.316.9	0,5
NPT 3/4"	-	-	-	-	-	-	-	50	880.320.9	0,8
NPT 1"	-	-	-	-	-	-	-	50	880.326.9	1,3
NPT 1.1/4"	-	-	-	-	-	-	-	20	880.335.9	1,8
NPT 1.1/2"	-	-	-	-	-	-	-	20	880.340.9	2,2
NPT 2"	-	-	-	-	-	-	-	20	880.350.9	2,8
NPT 2.1/2"	-	-	-	-	-	-	-	5	880.363.9	3,5
NPT 3"	-	-	-	-	-	-	-	5	880.375.9	5,6



Neoprene sealing gasket for ISO



THREAD ISO	THREAD PG	THREAD NPT	DIMENSIONS IN MM					STANDARD PACKAGE	ARTICLE NUMBER	WEIGHT (KG/100)
			A	B	C	D	E			
M16 x 1,5	-	-	1,2	-	20	14	-	100	815.416.0	0,03
M20 x 1,5	-	-	1,2	-	24	18	-	100	815.420.0	0,03
M25 x 1,5	-	-	1,2	-	30	23	-	50	815.425.0	0,05
M32 x 1,5	-	-	1,2	-	40	30	-	50	815.432.0	0,11
M40 x 1,5	-	-	1,2	-	48	38	-	50	815.440.0	0,15
M50 x 1,5	-	-	1,2	-	58	48	-	50	815.450.0	0,19
M63 x 1,5	-	-	1,2	-	75	61	-	50	815.463.0	0,33



Neoprene sealing gasket for Pg / NPT



THREAD ISO	THREAD PG	THREAD NPT	DIMENSIONS IN MM					STANDARD PACKAGE	ARTICLE NUMBER	WEIGHT (KG/100)
			A	B	C	D	E			
-	Pg 7	-	1,2	-	17	11,5	-	100	815.507.0	0,03
-	Pg 9	-	1,2	-	20	14	-	100	815.509.0	0,03
-	Pg 11	-	1,2	-	23	17	-	100	815.511.0	0,03
-	Pg 13,5	-	1,2	-	25	19	-	100	815.513.0	0,04
-	Pg 16	NPT 1/2"	1,2	-	27	21	-	100	815.516.0	0,05
-	Pg 21	NPT 3/4"	1,2	-	34	26,5	-	50	815.521.0	0,07
-	Pg 29	NPT 1"	1,2	-	45	35	-	50	815.529.0	0,13
-	Pg 36	NPT 1.1/4"	1,2	-	56	45	-	50	815.536.0	0,19
-	Pg 42	NPT 1.1/2"	1,2	-	67	52	-	50	815.542.0	0,3
-	Pg 48	NPT 2"	1,2	-	72	58	-	50	815.548.0	0,34



NBR rubber seal for NPT



THREAD	SEALTITE SIZE (INCH)	MIN. INTERNAL BORE (MM)	DIMENSIONS IN MM					STANDARD PACKAGE	ARTICLE NUMBER	WEIGHT (KG/100)
			A	B	C	D	E			
NPT 1/2"	1/2"	-	-	-	-	-	-	50	815.616.0	0,03
NPT 3/4"	3/4"	-	-	-	-	-	-	25	815.620.0	0,05
NPT 1"	1"	-	-	-	-	-	-	25	815.626.0	0,11
NPT 1.1/4"	1.1/4"	-	-	-	-	-	-	10	815.635.0	0,15
NPT 1.1/2"	1.1/2"	-	-	-	-	-	-	10	815.640.0	0,19
NPT 2"	2"	-	-	-	-	-	-	10	815.650.0	0,33
NPT 2.1/2"	2.1/2"	-	-	-	-	-	-	10	815.663.0	0,45
NPT 3"	3"	-	-	-	-	-	-	10	815.675.0	0,6

## ACCESSORIES FOR STAINLESS STEEL FITTINGS



Grounding ferrule, stainless steel AISI-316



THREAD	SEALTITE SIZE (INCH)	MIN. INTERNAL BORE (MM)	DIMENSIONS IN MM					STANDARD PACKAGE	ARTICLE NUMBER	WEIGHT (KG/100)
			A	B	C	D	E			
-	3/8"	10,2	-	-	-	-	-	10	815.011.9	0,6
-	1/2"	13,9	-	-	-	-	-	10	815.016.9	0,8
-	3/4"	18,5	-	-	-	-	-	5	815.021.9	1,4
-	1"	23,8	-	-	-	-	-	5	815.029.9	2,8



ISO locknut, stainless steel AISI-316



THREAD	SEALTITE SIZE (INCH)	MIN. INTERNAL BORE (MM)	DIMENSIONS IN MM					STANDARD PACKAGE	ARTICLE NUMBER	WEIGHT (KG/100)
			A	B	C	D	E			
M16 x 1,5	-	-	3,2	-	20	-	-	50	880.116.8	0,5
M20 x 1,5	-	-	3,6	-	24	-	-	50	880.120.8	0,7
M25 x 1,5	-	-	3,6	-	29	-	-	25	880.125.8	1,1
M32 x 1,5	-	-	4,6	-	35	-	-	25	880.132.8	2,4
M40 x 1,5	-	-	5	-	46	-	-	5	880.140.8	3,6
M50 x 1,5	-	-	5	-	60	-	-	5	880.150.8	5,4
M63 x 1,5	-	-	6	-	70	-	-	5	880.163.8	6,2



NPT locknut, stainless steel AISI-316



THREAD	SEALTITE SIZE (INCH)	MIN. INTERNAL BORE (MM)	DIMENSIONS IN MM					STANDARD PACKAGE	ARTICLE NUMBER	WEIGHT (KG/100)
			A	B	C	D	E			
NPT 1/2"	-	-	4	-	27	-	-	50	880.216.8	1,1
NPT 3/4"	-	-	4,5	-	32	-	-	25	880.220.8	1,4
NPT 1"	-	-	6	-	38	-	-	25	880.226.8	2,1
NPT 1.1/4"	-	-	6,5	-	48	-	-	5	880.235.8	3,5
NPT 1.1/2"	-	-	7	-	55	-	-	5	880.240.8	5
NPT 2"	-	-	7,5	-	70	-	-	5	880.250.8	8,8



Special fittings



Earth tags, stainless steel AISI-316 for ISO / NPT



THREAD ISO	THREAD PG	THREAD NPT	DIMENSIONS IN MM					STANDARD PACKAGE	ARTICLE NUMBER	WEIGHT (KG/100)
			A	B	C	D	E			
M16 x 1,5	-	-	25	16	13	6,2	30	50	880.610.8	-
M20 x 1,5	-	-	29	20	13	6,2	33	50	880.612.8	-
M25 x 1,5	-	-	34	25	13	6,2	36	50	880.613.8	-
M32 x 1,5	-	-	42	32	22	12,2	41	50	880.620.8	-
M40 x 1,5	-	-	54	40	26	14,2	47	50	880.627.8	-
M50 x 1,5	-	-	67	50	29	14,2	64	50	880.635.8	-
M63 x 1,5	-	-	77	63	29	14,2	73	50	880.650.8	-
-	-	NPT 1/2"	29	22	13	6,2	33	50	880.716.8	-
-	-	NPT 3/4"	34	27	13	6,2	36	50	880.720.8	-
-	-	NPT 1"	42	34	22	12,2	41	50	880.726.8	-
-	-	NPT 1.1/4"	54	42	26	14,2	47	50	880.735.8	-
-	-	NPT 1.1/2"	67	49	29	14,2	64	50	880.740.8	-
-	-	NPT 2"	77	61	29	14,2	73	50	880.750.8	-

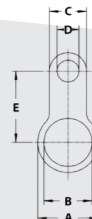

## ACCESSORIES FOR GALVANISED STEEL FITTINGS



Grounding ferrule, galvanised steel



THREAD	SEALTITE SIZE (INCH)	MIN. INTERNAL BORE (MM)	DIMENSIONS IN MM					STANDARD PACKAGE	ARTICLE NUMBER	WEIGHT (KG/100)
			A	B	C	D	E			
-	3/8"	10,4	-	-	-	-	-	50	297.212.0	1,3
-	1/2"	13,7	-	-	-	-	-	25	297.216.0	1,3
-	3/4"	18,8	-	-	-	-	-	25	297.220.0	1,4
-	1"	24,2	-	-	-	-	-	25	297.226.0	1,8
-	1.1/4"	31,6	-	-	-	-	-	5	297.235.0	2
-	1.1/2"	36,8	-	-	-	-	-	5	297.240.0	2,4
-	2"	48	-	-	-	-	-	5	297.250.0	2,8
-	2.1/2"	58,5	-	-	-	-	-	5	297.263.0	6,4
-	3"	72	-	-	-	-	-	5	297.275.0	7,2
-	4"	95	-	-	-	-	-	1	297.299.0	7,6

\* From 1.1/4" the ferrule is made in aluminum

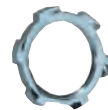

NPT lock nut, galvanised steel, with "tiger grip"



THREAD	SEALTITE SIZE (INCH)	MIN. INTERNAL BORE (MM)	DIMENSIONS IN MM					STANDARD PACKAGE	ARTICLE NUMBER	WEIGHT (KG/100)
			A	B	C	D	E			
NPT 1/2"	-	-	-	-	-	-	-	100	297.416.0	0,5
NPT 3/4"	-	-	-	-	-	-	-	100	297.420.0	0,8
NPT 1"	-	-	-	-	-	-	-	50	297.426.0	1,3
NPT 1.1/4"	-	-	-	-	-	-	-	50	297.435.0	1,8
NPT 1.1/2"	-	-	-	-	-	-	-	50	297.440.0	2,2
NPT 2"	-	-	-	-	-	-	-	25	297.450.0	2,8
NPT 2.1/2"	-	-	-	-	-	-	-	1	297.463.0	3,5
NPT 3"	-	-	-	-	-	-	-	1	297.475.0	5,6
NPT 4"	-	-	-	-	-	-	-	1	297.499.0	9,8



Neoprene ring for NPT, with galvanised steel back plate



THREAD	SEALTITE SIZE (INCH)	MIN. INTERNAL BORE (MM)	DIMENSIONS IN MM					STANDARD PACKAGE	ARTICLE NUMBER	WEIGHT (KG/100)
			A	B	C	D	E			
NPT 1/2"	-	-	-	-	-	-	-	100	297.016.0	0,5
NPT 3/4"	-	-	-	-	-	-	-	100	297.020.0	0,5
NPT 1"	-	-	-	-	-	-	-	50	297.026.0	0,6
NPT 1.1/4"	-	-	-	-	-	-	-	50	297.035.0	0,8
NPT 1.1/2"	-	-	-	-	-	-	-	50	297.040.0	1,4
NPT 2"	-	-	-	-	-	-	-	50	297.050.0	1,4

## ACCESSORIES FOR GALVANISED STEEL FITTINGS



Nut with external grounding, galvanized steel



THREAD	SEALTITE SIZE (INCH)	MIN. INTERNAL BORE (MM)	DIMENSIONS IN MM					STANDARD PACKAGE	ARTICLE NUMBER	WEIGHT (KG/100)
			A	B	C	D	E			
-	3/8"	-	-	-	26	-	-	25	297.512.0	2,8
-	1/2"	-	-	-	29	-	-	25	297.516.0	3,4
-	3/4"	-	-	-	35	-	-	10	297.520.0	-
-	1"	-	-	-	42	-	-	5	297.526.0	-
-	1 1/4"	-	-	-	56	-	-	5	297.535.0	-
-	1 1/2"	-	-	-	64	-	-	1	297.540.0	-
-	2"	-	-	-	77	-	-	1	297.550.0	-



Wire mesh, strain relief, galvanized steel



THREAD	SEALTITE SIZE (INCH)	MIN. INTERNAL BORE (MM)	DIMENSIONS IN MM					STANDARD PACKAGE	ARTICLE NUMBER	WEIGHT (KG/100)
			A	B	C	D	E			
-	3/8"	-	-	-	26	-	-	20	297.312.0	2,5
-	1/2"	-	-	-	29	-	-	20	297.316.0	5
-	3/4"	-	-	-	35	-	-	20	297.320.0	7,5
-	1"	-	-	-	42	-	-	20	297.326.0	8,5
-	1 1/4"	-	-	-	56	-	-	10	297.335.0	10
-	1 1/2"	-	-	-	64	-	-	10	297.340.0	12
-	2"	-	-	-	77	-	-	5	297.350.0	14

Special fittings



## CONDUIT HOLDERS FOR SEALTITE CONDUIT



Single hole conduit holder, galvanised steel



THREAD	SEALTITE SIZE (INCH)	MIN. INTERNAL BORE (MM)	DIMENSIONS IN MM					STANDARD PACKAGE	ARTICLE NUMBER	WEIGHT (KG/100)
			A	B	C	D	E			
-	1/2"	21,5	45	15,5	5,0	40	-	25	885.016.0	0,7
-	3/4"	26,5	50	17,1	5,0	44	-	10	885.020.0	0,9
-	1"	33,5	60	18,9	6,0	52	-	5	885.026.0	1,8
-	1 1/4"	43,2	75	20,9	6,6	69	-	5	885.035.0	2,0



Double hole conduit holder, galvanised steel



THREAD	SEALTITE SIZE (INCH)	MIN. INTERNAL BORE (MM)	DIMENSIONS IN MM					STANDARD PACKAGE	ARTICLE NUMBER	WEIGHT (KG/100)
			A	B	C	D	E			
-	1/2"	21,5	64	15,5	5,0	49	-	25	885.016.2	0,9
-	3/4"	26,5	72	17,1	5,0	56	-	10	885.020.2	1,1
-	1"	33,5	86	18,9	6,0	66	-	5	885.026.2	2,1
-	1 1/4"	43,2	106	20,9	6,6	88	-	5	885.035.2	2,4
-	1 1/2"	46,2	116	21,7	6,6	95	-	2	885.040.2	4,2
-	2"	58,6	125	24,5	8,1	107	-	1	885.050.2	5,5

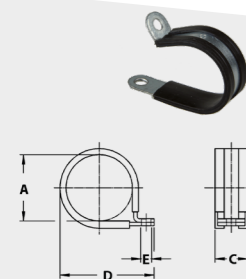

Conduit mounting clip, galvanised steel



THREAD	SEALTITE SIZE (INCH)	MIN. INTERNAL BORE (MM)	DIMENSIONS IN MM					STANDARD PACKAGE	ARTICLE NUMBER	WEIGHT (KG/100)
			A	B	C	D	E			
-	1/4"	-	10	-	12,5	25	4,2	100	885.306.0	0,4
-	5/16"	-	13	-	12,5	27	4,2	100	885.310.0	0,4
-	3/8"	-	18	-	11	34	4,2	100	885.312.0	0,5
-	1/2"	-	21	-	15,5	40	5,5	100	885.316.0	1
-	3/4"	-	29	-	15,5	48	5,5	50	885.320.0	1,2
-	1"	-	35	-	18	60	6,2	30	885.326.0	2,2
-	1 1/4"	-	42	-	18	74	6,3	20	885.335.0	2,7
-	1 1/2"	-	54	-	18,5	86	6,2	20	885.340.0	3,2
-	2"	-	58	-	18	90	6,3	20	885.350.0	3,6
-	2 1/2"	-	79	-	25	100	8,5	1	885.363.0	8,4

# Conduit connectors for rigid piping, IP 67



## ANACONDA CONDUIT CONNECTORS FOR EN-60423 NORM RIGID PIPING, NICKEL PLATED BRASS

Anaconda nickel plated brass conduit / rigid pipe connectors are designed to connect an Anaconda Sealtite flexible conduit to an EN-60423 rigid metric pipe. These connectors are using a double O-ring construction to ensure a reliable IP 67 leaktight connection. A high pull out strength is achieved by firmly fastening the compression nut onto the pipe using a wrench.

### Material & Construction:

**Construction:** Nickel plated brass fitting, consisting of 9 parts (counter nut, clamping ring, ferrule, intermediate part, 2 O-rings, filler ring, pipe clamping ring and compression nut).

**Material:** Counter nut, intermediate part, filler ring, pipe clamping ring and compression nut are made from nickel plated brass.

The clamping ring is made from PA6. The ferrule is made from galvanised steel and the 2 O-rings are made from NBR rubber.

**Temperature:** -45 °C till +105 °C continuous.

**Protection class:** IP 67.

**Colour:** Metal coloured.

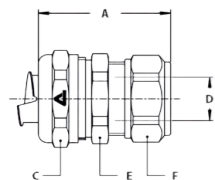

Anaconda straight conduit connector for EN-60423 rigid piping, nickel plated brass



Special fittings

METRIC PIPE DIAM.	SEALTITE SIZE (INCH)	MIN. INTERNAL BORE (MM)	DIMENSIONS IN MM						STANDARD PACKAGE	ARTICLE NUMBER	WEIGHT (KG/100)
			A	B	C	E	F				
16	5/16"	8,3	43	26	16	24	26	10	705.015.0	8,7	
16	3/8"	11	43	26	16	24	26	10	705.016.1	8,3	
16	1/2"	14	43	29	16	27	26	10	705.018.1	8,8	
20	1/2"	14,5	44	29	20	28	30	10	705.020.1	9,9	
20	3/4"	18	46	35	20	34	30	5	705.023.1	12,5	
25	1"	22	48	45	25	42	36	5	705.028.1	20	
32	1 1/4"	29	53	53	32	50	45	2	705.035.1	29	

# Double seal cable glands, nickel plated brass



## ANACONDA CABLE GLANDS WITH DOUBLE LAYER SEALS

Anaconda nickel plated brass cable glands contain two clamping seals, one with a larger diameter seal into which a smaller diameter seal fits. Both seals are made of VO rated EPDM rubber, tested and certified in compliance with EN45545-2, Hazard Level (HL1 / HL2 / HL3) for rail applications. When a larger diameter cable is used the larger diameter seal can be used on its own and when a smaller diameter cable is used both clamping seals are required with the smaller one inserted inside the larger one. Both seals are supplied standard as part of the cable gland. The double seal cable glands can also be used with braided cables for EMC applications by simply folding the end of the braid over the top of the clamping seal(s) before mounting.

### Material & Construction:

**Construction:** Nickel plated brass fitting, consisting of 3 parts (body, counter nut and double clamping seal).

**Material:** The body and counter nut are nickel plated brass. The clamping seals are made from EPDM rubber.

**Special approvals:** The cable-hose fittings have clamping seals from flame retardant VO-rated EPDM rubber and are HL 1, HL 2 and HL 3 according to EN 45545-2, R22 and R23.

**Temperature:** -55 °C till +125 °C continuous.

**Protection class:** IP 68.

**Colour:** Metal coloured.

ISO cable gland, male, nickel plated brass  
(with double layer EPDM seal)

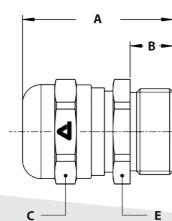

THREAD ISO	CLAMPING RANGE (MM)		DIMENSIONS IN MM					STANDARD PACKAGE	ARTICLE NUMBER	WEIGHT (KG/100)
	S1+S2	S1	A	B	C	D	E			
M12 x 1,5	1,0 - 4,0	4,0 - 6,5	29	9	14	-	14	10	726.712.1	1,9
M16 x 1,5	1,0 - 4,0	4,0 - 6,5	30	10	14	-	18	10	726.713.1	2,7
M16 x 1,5	4,0 - 6,5	6,5 - 9,5	32	10	17	-	18	10	726.716.1	3
M20 x 1,5	4,0 - 6,5	6,5 - 9,5	32	10	17	-	22	10	726.717.1	3,7
M20 x 1,5	6,0 - 9,0	9,0 - 13	35	10	22	-	22	10	726.720.1	3,8
M25 x 1,5	6,0 - 9,0	9,0 - 13	36	10	22	-	27	5	726.722.1	5,3
M25 x 1,5	11 - 14	14 - 18	38	10	27	-	27	5	726.725.1	5,8
M32 x 1,5	11 - 14	14 - 18	40	12	27	-	35	5	726.728.1	9
M32 x 1,5	16 - 20	20 - 25	42	12	35	-	35	5	726.732.1	9,9
M40 x 1,5	16 - 20	20 - 25	43	13	35	-	43	2	726.735.1	14,3
M40 x 1,5	22 - 27	27 - 32	45	13	43	-	43	2	726.740.1	15,2
M50 x 1,5	22 - 27	27 - 32	46	14	43	-	55	2	726.745.1	21,5
M50 x 1,5	30 - 35	35 - 40	50	14	53	-	55	2	726.750.1	23
M63 x 1,5	30 - 35	35 - 40	53	16	53	-	70	2	726.755.1	41
M63 x 1,5	40 - 45	45 - 50	57	16	65	-	70	2	726.763.1	43

# Double seal cable glands, nickel plated brass, UL / CSA



## ANACONDA CABLE GLANDS UL / CSA , NICKEL PLATED BRASS, WITH DOUBLE LAYER SEALS

Anaconda nickel plated brass cable glands contain two clamping seals, one with a larger diameter seal into which a smaller diameter seal fits. Both seals are made of V0 rated EPDM rubber, tested and certified in compliance with EN45545-2, Hazard Level (HL1 / HL2 / HL3) for rail applications. When a larger diameter cable is used the larger diameter seal can be used on its own and when a smaller diameter cable is used both clamping seals are required with the smaller one inserted inside the larger one. Both seals are supplied standard as part of the cable gland. The double seal cable glands can also be used with braided cables for EMC applications by simply folding the end of the braid over the top of the clamping seal(s) before mounting. The cable glands are UL / CSA approved for export outside Europe and have an extra robust counter nut, as well as an increased clamping strength.

### Material & Construction:

- Construction:** Nickel plated brass fitting, consisting of 3 parts (body, counter nut and double clamping seal).  
**Material:** The body and counter nut are nickel plated brass. The clamping seals are made from EPDM rubber.  
**Special approvals:** UL-514B and CSA C 22.2 (combined UL / CSA file # E 500099), suitable for use in hazardous environments according to NEC:  
 - Article 501.10 (B) (2) Class I, Division 2.  
 - Article 502.10 (A) (2) and (B) (2).
- Class II, Division 1 and 2.
  - Article 503.10 (A) (3) and (B).
  - Class III, Division 1 and 2.
  - Suitable for rail applications HL 1, HL 2 and HL 3 according to EN 45545-2, R22 and R23.
  - Temperature:** -45 °C till +105 °C continuous.
  - Protection class:** IP 68.
  - Colour:** Metal.

ISO cable gland, male, nickel plated brass  
(with double layer EPDM seal)

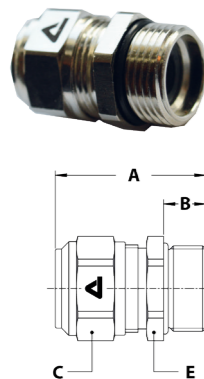

THREAD ISO	CLAMPING RANGE (MM)		DIMENSIONS IN MM					STANDARD PACKAGE	ARTICLE NUMBER	WEIGHT (KG/100)
	S 1 + S 2*	S 1	A	B	C	D	E			
M16 x 1,5	4,0 - 6,5	6,5 - 8,5	32	10	17	-	18	10	736.716.1**	3
M20 x 1,5	4,0 - 6,5	6,5 - 8,5	32	10	17	-	22	10	736.717.1	3,7
M20 x 1,5	6,0 - 9,0	9,0 - 12	35	10	22	-	22	10	736.720.1	3,8
M25 x 1,5	6,0 - 9,0	9,0 - 12	36	10	22	-	27	5	736.722.1	5,3
M25 x 1,5	10,5 - 14	14 - 17	38	10	27	-	27	5	736.725.1	5,8
M32 x 1,5	10,5 - 14	14 - 17	40	12	27	-	35	5	736.728.1	9
M32 x 1,5	15,5 - 20	20 - 24	42	12	35	-	35	5	736.732.1	9,9
M40 x 1,5	15,5 - 20	20 - 24	43	13	35	-	43	2	736.735.1	14,3
M40 x 1,5	22 - 27	27 - 31	45	13	43	-	43	2	736.740.1	15,2
M50 x 1,5	22 - 27	27 - 31	46	14	43	-	55	2	736.745.1	21,5
M50 x 1,5	29,5 - 35	35 - 40	50	14	53	-	55	2	736.750.1	23
M63 x 1,5	29,5 - 35	35 - 40	53	16	53	-	70	2	736.755.1	41

\* For UL / CSA applications requiring a pull out strength of 159 N, increase the indicated minimum clamping diameter for the double seal with 1,5 mm.

\*\* Size M16x1,5 with UL recognition (UR) instead of UL listing.

Special fittings

## DOUBLE SEAL CABLE GLANDS, NICKEL PLATED BRASS, UL / CSA

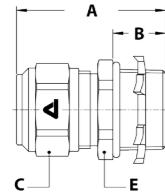

NPT cable gland, male, nickel plated brass (with double layer EPDM seal) including NBR flat seal and galvanised steel locknut



THREAD NPT	CLAMPING RANGE (MM)		DIMENSIONS IN MM					STANDARD PACKAGE	ARTICLE NUMBER	WEIGHT (KG/100)
	S 1 + S 2*	S 1	A	B	C	D	E			
1/2" NPT	4,0 - 6,5	6,5 - 8,5	36	14	17	-	24	10	738.712.2	4,6
1/2" NPT	6,0 - 9,0	9,0 - 12	39	14	22	-	24	10	738.716.2	5,1
3/4" NPT	6,0 - 9,0	9,0 - 12	40	14	22	-	30	5	738.718.2	6,8
3/4" NPT	10,5 - 14	14 - 17	42	14	27	-	30	5	738.720.2	7,3
1" NPT	10,5 - 14	14 - 17	44	16	27	-	38	5	738.723.2	10,9
1" NPT	15,5 - 20	20 - 24	46	16	35	-	38	5	738.726.2	11,8
1.1/4" NPT	15,5 - 20	20 - 24	46	16	35	-	48	2	738.730.2	17,5
1.1/4" NPT	22 - 27	27 - 31	48	16	43	-	48	2	738.735.2	18,5
1.1/2" NPT	22 - 27	27 - 31	50	18	43	-	55	2	738.738.2	23,5
1.1/2" NPT	29,5 - 35	35 - 40	64	18	53	-	55	2	738.740.2	30

\* For UL / CSA applications requiring a pull out strength of 159 N, increase the indicated minimum clamping diameter for the double seal with 1,5 mm.

# Double seal cable glands, stainless steel AISI-316, UL / CSA



## ANACONDA CABLE GLANDS UL / CSA, STAINLESS STEEL AISI-316, WITH DOUBLE LAYER SEALS

Anaconda stainless steel AISI-316 cable glands contain two clamping seals, one with a larger diameter seal into which a smaller diameter seal fits. Both seals are made of V0 rated EPDM rubber, tested and certified in compliance with EN45545-2, Hazard Level (HL1 / HL2 / HL3) for rail applications. When a larger diameter cable is used the larger diameter seal can be used on its own and when a smaller diameter cable is used both clamping seals are required with the smaller one inserted inside the larger one. The double seal cable glands can also be used with braided cables for EMC applications by simply folding the end of the braid over the top of the clamping seal(s) before mounting. Both seals are supplied standard as part of the cable gland. The cable glands are UL / CSA approved for export outside Europe and have an extra robust counter nut, as well as an increased clamping strength.

### Material & Construction:

**Construction:** Stainless steel AISI-316 fitting, consisting of 3 parts (body, counter nut and double clamping seal).

**Material:** The body and counter nut are stainless steel AISI-316. The clamping seals are made from EPDM rubber.

**Special approvals:** UL-514B and CSA C 22.2 (combined UL / CSA file # E 500099), suitable for use in hazardous environments according to NEC:

- Article 501.10 (B) (2) Class I, Division 2.
- Article 502.10 (A) (2) and (B) (2).

Class II, Division 1 and 2.

- Article 503.10 (A) (3) and (B)

Class III, Division 1 and 2.

For rail applications HL 1, HL 2 and HL 3 according to EN 45545-2, R22 and R23.

**Temperature:** -45 °C till +105 °C continuous.

**Protection class:** IP 68.

**Colour:** Metal.

ISO cable gland, male, stainless steel AISI-316  
(with double layer EPDM seal)



Special fittings

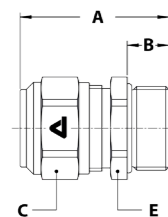
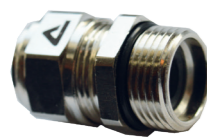

THREAD ISO	CLAMPING RANGE (MM)		DIMENSIONS IN MM					STANDARD PACKAGE	ARTICLE NUMBER	WEIGHT (KG/100)
	S 1 + S 2*	S 1	A	B	C	D	E			
M16 x 1,5	4,0 - 6,5	6,5 - 8,5	32	10	17	-	18	10	736.716.9**	3,0
M20 x 1,5	4,0 - 6,5	6,5 - 8,5	32	10	17	-	22	10	736.717.9	3,7
M20 x 1,5	6,0 - 9,0	9,0 - 12	35	10	22	-	22	10	736.720.9	3,8
M25 x 1,5	6,0 - 9,0	9,0 - 12	36	10	22	-	27	5	736.722.9	5,3
M25 x 1,5	10,5 - 14	14 - 17	38	10	27	-	27	5	736.725.9	5,8
M32 x 1,5	10,5 - 14	14 - 17	40	12	27	-	35	5	736.728.9	9,0
M32 x 1,5	15,5 - 20	20 - 24	42	12	35	-	35	5	736.732.9	9,9
M40 x 1,5	15,5 - 20	20 - 24	43	13	35	-	43	2	736.735.9	14,3
M40 x 1,5	22 - 27	27 - 31	45	13	43	-	43	2	736.740.9	15,2
M50 x 1,5	22 - 27	27 - 31	46	14	43	-	55	2	736.745.9	21,5
M50 x 1,5	29,5 - 35	35 - 40	50	14	53	-	55	2	736.750.9	23,0

\* For UL / CSA applications requiring a pull out strength of 159 N, increase the indicated minimum clamping diameter for the double seal with 1,5 mm.

\*\* Size M16x1,5 with UL recognition (UR) instead of UL listing.



## DOUBLE SEAL CABLE GLANDS, STAINLESS STEEL AISI-316, UL / CSA



NPT cable gland, male, stainless steel AISI-316 (with double layer EPDM seal) including NBR flat seal and stainless steel AISI-304 locknut

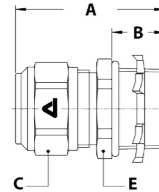

THREAD NPT	CLAMPING RANGE (MM)		DIMENSIONS IN MM					STANDARD PACKAGE	ARTICLE NUMBER	WEIGHT (KG/100)
	S 1 + S 2*	S 1	A	B	C	D	E			
1/2" NPT	4,0 - 6,5	6,5 - 8,5	36	14	17	-	24	10	738.712.92	4,6
1/2" NPT	6,0 - 9,0	9,0 - 12	39	14	22	-	24	10	738.716.92	5,1
3/4" NPT	6,0 - 9,0	9,0 - 12	40	14	22	-	30	5	738.718.92	6,8
3/4" NPT	10,5 - 14	14 - 17	42	14	27	-	30	5	738.720.92	7,3
1" NPT	10,5 - 14	14 - 17	44	16	27	-	38	5	738.723.92	10,9
1" NPT	15,5 - 20	20 - 24	46	16	35	-	38	5	738.726.92	11,8
1.1/4" NPT	15,5 - 20	20 - 24	46	16	35	-	48	2	738.730.92	17,5
1.1/4" NPT	22 - 27	27 - 31	48	16	43	-	48	2	738.735.92	18,5
1.1/2" NPT	22 - 27	27 - 31	50	18	43	-	55	2	738.738.92	23,5
1.1/2" NPT	29,5 - 35	35 - 40	64	18	53	-	55	2	738.740.92	30

\* For UL / CSA applications requiring a pull out strength of 159 N, increase the indicated minimum clamping diameter for the double seal with 1,5 mm.

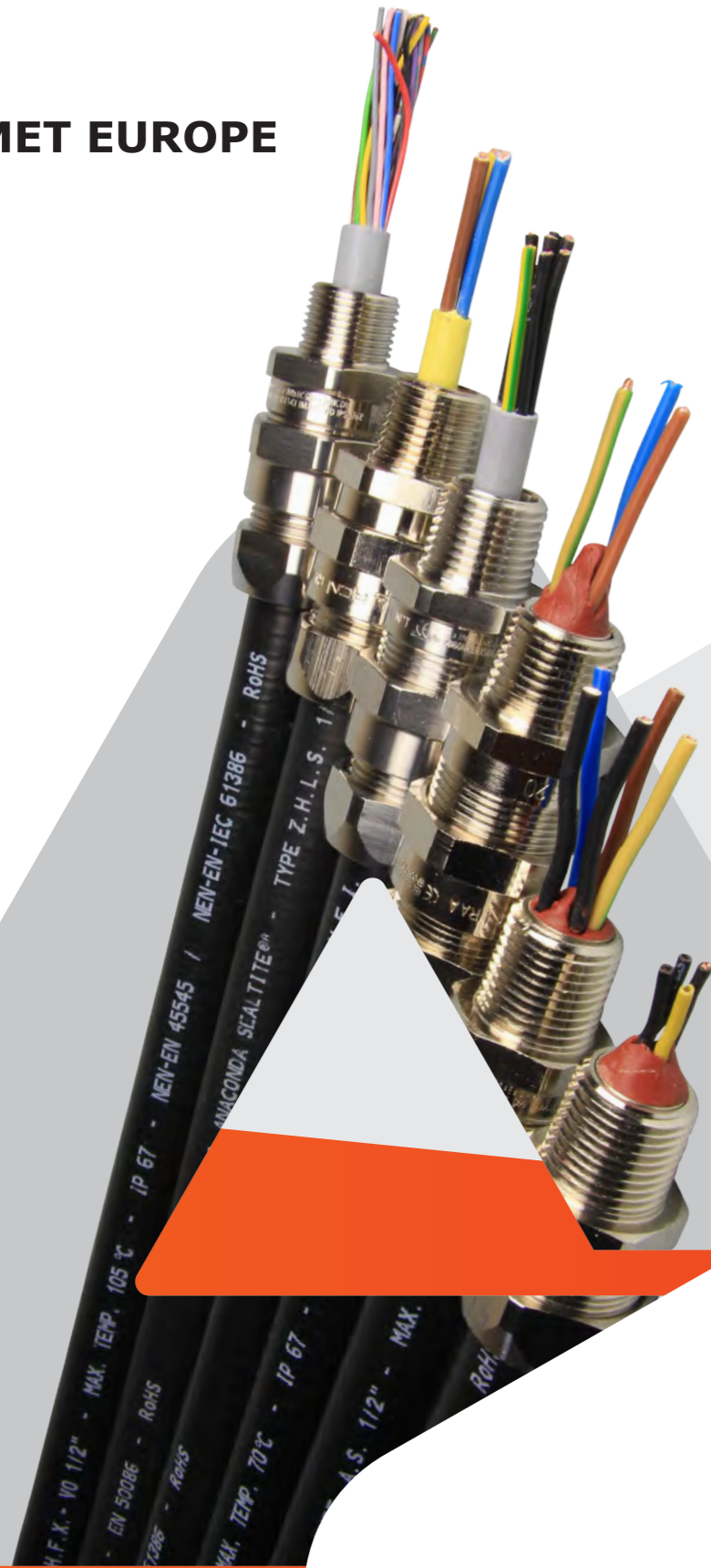

Atex  
fittings

# Atex fittings

# Conduit selection table Anaconda ATEX solutions

SEALTITE	MATERIAL	MATERIAL	TEMPERATURE		RESISTANCE (NEN-EN-IEC)			FLEXI-BILITY	RESISTANCE			APPROVALS	PROTEC-TION	PAGE
			Core	Cover	Min.	Max.	Compr.		Impact	Tensile	UV			
<b>AS Black</b>	Galvanised steel	PVC RoHS	-25 °C	70 °C	4 (1250N)	4 (6J)	4 (1000N)	+++	++++	+++		IP 66 IP 68	7 - 7	
<b>HFI-316 Blue</b>	Stainless steel AISI-316	TPU Halogen free RoHS	-55 °C	105 °C	4 (1250N)	4 (6J)	4 (1000N)	++++	++++	++++		IP 66 IP 68	7 - 8	
<b>HCI-316 Black</b>	Stainless steel AISI-316	PVC RoHS	-55 °C	105 °C	4 (1250N)	4 (6J)	4 (1000N)	+++	++++	++++		IP 66 IP 68	7 - 9	
<b>HGX Black</b>	Galvanised steel	TPE RoHS	-55 °C	+145 °C	4 (1250N)	4 (6J)	4 (1000N)	++++	+++	++		IP 66 IP 68	7 - 10	
<b>HTDL Black</b>	Galvanised steel	PVC RoHS	-45 °C	105 °C	4 (1250N)	4 (6J)	4 (1000N)	+++	++++	++++		IP 66 IP 68	7 - 11	

Fitting selection table Anaconda ATEX solutions

FITTING	MATERIAL	TEMPERATURE		THREAD SIZE RANGE			EXECUTION	APPROVALS				PROTEC-TION	PAGE
		Housing	Min.	Max.	Iso.	Pg		NPT	BARRIER	ATEX	IEC		
<b>BXA</b>	Nickel plated brass or Stainless steel AISI-316	-60 °C	130 °C	M16 to M40	-	1/2" - 1.1/4"	Yes				IP 66 IP 68	7 - 12 till 7 - 13	
<b>RNA / RAA</b>	Nickel plated brass or Stainless steel AISI-316	-65 °C	220 °C	M16 to M40	-	1/2" - 1.1/4"	No				IP 66 IP 68	7 - 14 till 7 - 23	
<b>BNA / BAA</b>	Nickel plated brass or Stainless steel AISI-316	-60 °C	150 °C	M16 to M40	-	1/2" - 1.1/4"	Yes				IP 66 IP 68	7 - 24 till 7 - 33	
<b>BXC</b>	Nickel plated brass or Stainless steel AISI-316	-60 °C	130 °C	M16 to M50	-	1/2" - 1.1/2"	Yes				IP 66 IP 68	7 - 34 till 7 - 37	
<b>RNC / RAC</b>	Nickel plated brass or Stainless steel AISI-316	-65 °C	220 °C	M16 to M90	-	1/2" - 3"	No				IP 66 IP 68	7 - 38 till 7 - 47	
<b>BNC / BAC</b>	Nickel plated brass or Stainless steel AISI-316	-60 °C	150 °C	M16 to M90	-	1/2" - 3"	Yes				IP 66 IP 68	7 - 48 till 7 - 55	
<b>BXN</b>	Nickel plated brass or Stainless steel AISI-316	-60 °C	130 °C	M16 to M50	-	1/2" - 1.1/2"	Yes				IP 66 IP 68	7 - 56 till 7 - 57	
<b>RN</b>	Nickel plated brass or Stainless steel AISI-316	-65 °C	220 °C	M16 to M90	-	1/2" - 3"	No				IP 66 IP 68	7 - 58 till 7 - 61	
<b>RAD</b>	Nickel plated brass or Stainless steel AISI-316	-65 °C	220 °C	M16 to M90	-	1/2" - 3"	No				IP 66 IP 68	7 - 62 till 7 - 65	

# Engineering data Anaconda IECEX-ATEX solutions

## DESCRIPTION ANACONDA IECEX-ATEX CABLE-HOSE FITTINGS

The Anaconda IECEX-ATEX certified cable-hose fittings together with Anaconda Sealrite conduits are the ideal solution for the mechanical protection of cables and the connection of equipment in a safe and explosion proof way. The temperature range of the standard version with an internal seal in EPDM is -40°C and +100 °C, while the temperature range of the internal seal in silicone is -65 °C to + 220°C. The new barrier type with a 2 component epoxy resin has a temperature range from -60°C till +130°C.

The Anaconda IECEX-ATEX cable-hose fittings are also available in EMC version (shielded) for the connection of armoured cables. They are available in nickel plated brass or in stainless steel AISI-316. The protection grade as delivered is IP 66, but can be increased to IP 68 by using an additional flat seal between body and enclosure (to be ordered separately).

### Classification of explosion risk zones according to ATEX:

The Explosion risk zones are classified based on a risk analysis, determining to what degree a zone in the presence of gas or dust is considered an explosion risk.

- Zone 0 (Gas) and Zone 20 (Dust): place with continuous presence or long duration of an explosive atmosphere.
- Zone 1 (Gas) and Zone 21 (Dust): place where during normal functioning an explosive atmosphere is occasionally present.

- Zone 2 (Gas) and Zone 22 (Dust): place where an explosive atmosphere is impossible during normal functioning or that it is present only infrequently and for short periods.

According to Directive 2014 / 34 / EU the equipment to be used in Ex-zones has to be certified and ATEX marked. To this end equipment is divided in groups and categories, according to the zones in which they are used.

Group I = equipment for use in mining

Hazardous Atmosphere	Risk	Zone	Category Equipment	Anaconda Atex System allowed	Security level
Mine Gas, Combustible Dusts	Continuously or for long periods	0	I M1	No	Very high (also safe in case of 2 independent defects)
Mine Gas, Combustible Dusts	Occasionally	1	I M2	Yes	High (also safe in case of 1 defect)

Atex fittings

Group II = equipment for use in all other explosive atmospheres

Hazardous Atmosphere	Risk	Zone	Category Equipment	Anaconda Atex System allowed	Security level
Gases, Vapours and Mists	Continuously or for long periods	0	II Ga	No	Very high (also safe in case of 2 independent defects)
Gases, Vapours and Mists	Occasionally	1	II Gb	Yes	High (also safe in case of 1 defect)
Gases, Vapours and Mists	Infrequently or for short periods	2	II Gc	Yes	Normal (safe during normal functioning)
Dusts	Continuously or for long periods	20	III Da	No	Very high (also safe in case of 2 independent defects)
Dusts	Occasionally	21	III Db	Yes	High (also safe in case of 1 defect)
Dusts	Infrequently or for short periods	22	III Dc	Yes	High (conducting dusts) Normal (non-conducting dusts)

# Engineering data Anaconda IECEX-ATEX solutions

Type explanation Anaconda IECEX-ATEX conduit fittings:

- |          |                            |          |   |          |   |
|----------|----------------------------|----------|---|----------|---|
| <b>1</b> | R = regular<br>B = barrier | <b>2</b> | N = non armoured cable<br>A = armoured cable*<br>X = loose wires and cable stripped | <b>3</b> | A = directly on Anaconda conduit<br>C = male / female adapter<br>N / D = cable-gland single / double seal |
|----------|----------------------------|----------|---|----------|---|

## For instance:

Type BXA is a barrier fitting for loose wires and unarmoured cable, directly connected on an Anaconda conduit.

\* Note: Armoured cable can be metal braided cable or SWA cable for EMC shielding.

## Certification and marking

Certification and marking of Anaconda IECEX-ATEX cable-hose fitting, according to standards:

EN 60079-0 and IEC 60079-0

EN 60079-1 and IEC 60079-1

EN 60079-7 and IEC 60079-7

EN 60079-31 and IEC 60079-31

Next to the certification and marking according to directive 2014 / 34 / EU the Anaconda cable-hose fittings are certified and marked according to the above mentioned EN and IEC standards:

Ex db I Mb / Ex eb I Mb / Ex db IIC Gb / Ex eb IIC Gb / Ex tb IIC Db

## Selection of cable-glands / fittings and cables

For the protection method flameproof enclosure "d", it is allowed to use cable-glands and cable-hose fittings without barrier under the condition that:

- The glands / fittings are Exd certified and marked as equipment.
- Cables used shall be appropriate for the ambient conditions in service and shall be sheathed with thermoplastic, thermo-setting, or elastomeric material. They shall be circular and compact. Any bedding or sheath shall be extruded. Fillers, if any, shall be non-hygroscopic.
- The connected cable is at least 3 meter in length.

If any of the above conditions is not fulfilled, it is required to use a barrier type of gland / fitting.

For the protection method increased safety "e", these conditions are not applicable.

For all protection methods applies that the gland / fitting shall be selected to match the cable diameter. The use of sealing tape, heat shrink tube or other materials is NOT permitted to make the cable fit to the gland / fitting.

## Degree of protection

The degree of protection of the glands / fittings is IP 66 or IP 66 / IP 68. The IP 68 degree of protection is obtained by using a flat sealing ring on the versions with cylindrical threads. In all other situations (without sealing ring) the threaded parts must be sealed with Loctite or similar to guarantee IP 66 or IP 66 / IP 68.

# Engineering data Anaconda IECEX-ATEX solutions

Localisation of Gas and Dust Ex-Zones

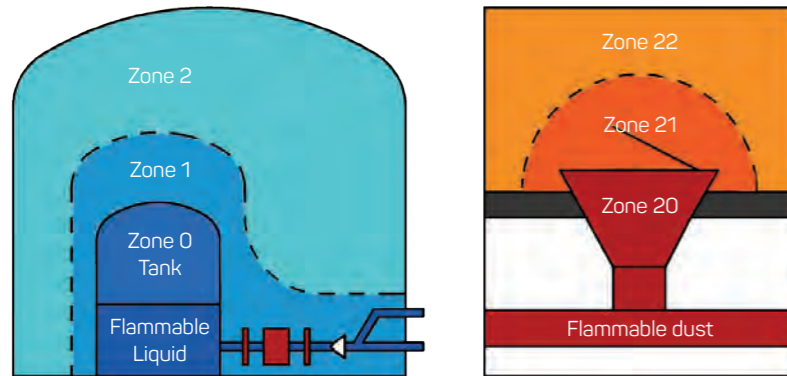

IECEX-ATEX conduit fitting selection table:

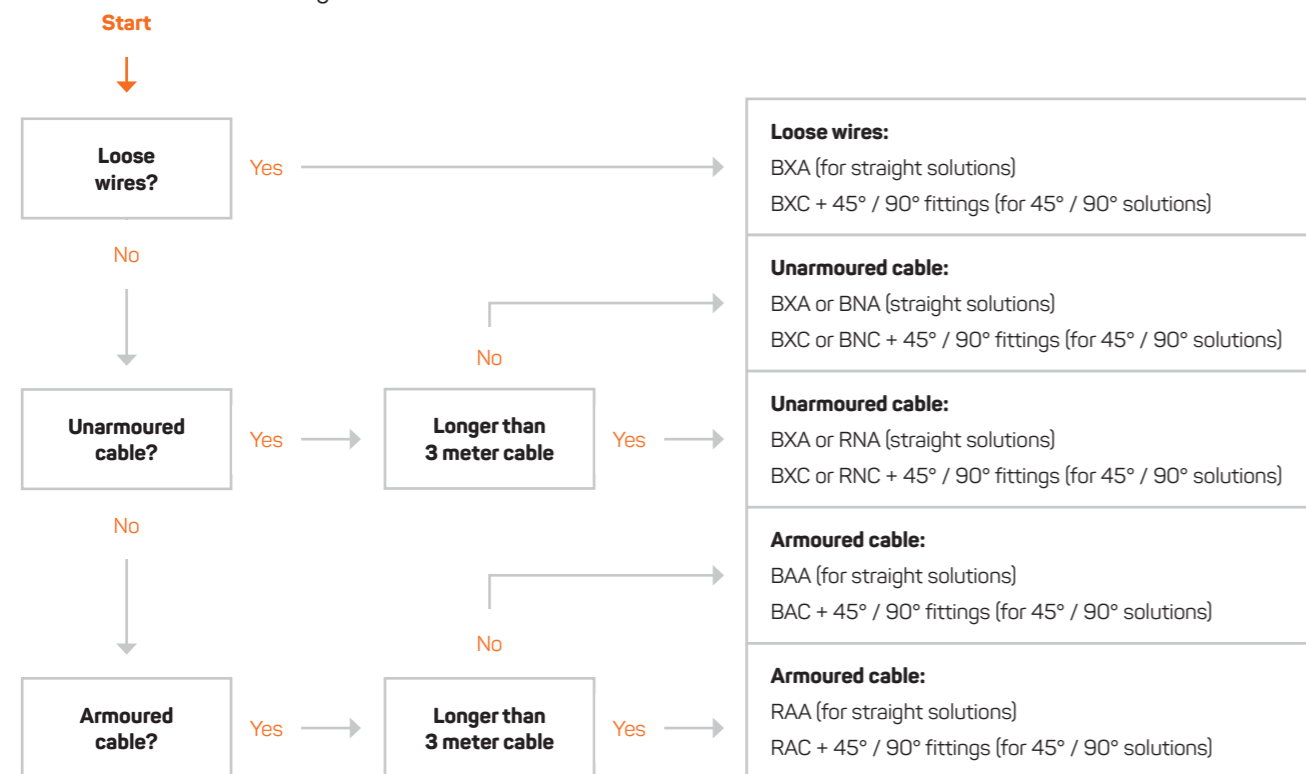

In case of cable-glands and cable adapters the selection will be:

Loose wires = type BXN and BXC

Unarmoured cable longer than 3 meter = type BXN and BXC or RN and RNC

Unarmoured cable shorter than 3 meter = type BXN and BXC or BN and BNC

Armoured cable longer than 3 meter = type RAC and RAD

Armoured cable shorter than 3 meter = type BAC and BAD



# Engineering data Anaconda IECEX-ATEX solutions

## Certification:

The cable-hose versions type BXA are specifically approved for the Anaconda Sealtite protection conduits. The types BXC and BXN can be used as universal cable adapters and cable-glands.

### All are covered by the following certificates:

ATEX: CESI 14ATEX069X  
IECEX: IECEX CES 15.0001X  
EAC: RuC-IT.A 45.B.00081

The cable-hose versions RNA / RAA / BAA and the cable adapter versions RNC / RAC / BAC can be used in combination with each type of protective conduit.

The cable-gland versions RN / BN / RAD / BAN can be used in combination with just cables.

### All are covered by the following certificates:

ATEX: INERIS 06ATEX0014X  
IECEX: INE 10.0010X  
EAC: RuC-IT.A 45.B.00081

### All ATEX approved accessories are covered by the following certificates:

ATEX: INERIS 12 ATEX 0089X  
IECEX: INE 10.0014X  
EAC: RuC-IT.A 45.B.00081

## Differences between European and North American standards regarding protection against explosion

FCEN	CONSTANT PRESENCE RISK	OCCASIONAL PRESENCE RISK	PRESENCE RISK ONLY IN CASE OF A DEFECT
IEC / EUROPE	zone 0	zone 1	zone 2
U.S. / CANADA	Division I		Division II

RISK CATEGORY	IEC / EUROPE	U.S. / CANADA	IGNITION ENERGY
Methane	Group I	Not classified	
Acetylene	Group II C	Class I Group A	> 20 u J
Hydrogen	Group II C	Class I Group B	> 20 u J
Ethylene	Group II B	Class I Group C	> 60 u J
Propane	Group II A	Class I Group D	> 180 u J
Metallic conducting dust	In preparation	Class II Group E	
Non metallic conducting dust	In preparation	Class II Group E	
Non conducting dust	In preparation	Class II Group F	
Fibres	Not classified	Class III	

According to directive NEC 50110 (A) [2], the use of flexible metal conduit is not permitted for Class 1 Division I; only cables inserted in rigid pipes with block joints or special armoured cables with special barrier type fittings are allowed.

For class 1 division II, for class 2 division I and II, for class 3 division I and II both rigid pipes and flexible conduit and fittings are permitted under the condition that they are UL listed. The Anaconda Sealtite conduits type HTDL, HTUA, UA and ZHUA as well as the regular Anaconda / Anamet fittings are UL listed and thus already permitted for this use.

# Anaconda Sealtite conduit

## TYPE AS BLACK



### ROBUST AND ANTI-STATIC

Type AS is a robust conduit with a galvanised steel core and a thick, smooth antistatic PVC cover for use in hazardous areas where a risk of explosion exists. The conduit cover provides a surface resistance of  $<10^9$  Ohm according to Standard NEN-EN-IEC 600079-0, Section 26-13 thus preventing electrostatic charge from accumulating on the surface of the conduit cover and also sparks in the case of discharge by contact.

#### Material & Construction:

**Construction:** Galvanised steel core, square locked with cord packing, thick smooth thermoplastic cover (PVC component).  
From 1.1/2" a fully inter locked profile will be used.  
**Cover specifications:** Antistatic PVC, lead-free according to RoHS, sunlight and UV resistant, suitable for outdoor use and burial installation.

**Anti-Static performance:** Surface resistance  $< 10^9$  Ohm, meeting the requirements of standard NEN-EN-IEC 60079-0, section 26-13.  
**Temperature:** -25 °C till +70 °C, intermittent up to +90 °C.  
**Colour:** Black.



Square locked from 5/16" - 1.1/4"



Inter locked for size 1.1/2" and 2"

#### Classification according to NEN-EN-IEC 61386:

**Compression resistance:** Class 4, Heavy (1250 N).  
**Impact resistance:** Class 4, Heavy (6 J).  
**Tensile strength:** Class 4, Heavy (1000 N).  
**Protection class:** IP 66 / 67 (dustproof, watertight).

Atex fittings

SEALTITE	DIAMETRE		BENDING RADIUS (CL)		STANDARD CARTON		SMALL CARTON		REEL		WEIGHT (kg/m)	
	Size (inch)	Inside (mm)	Outside (mm)	Static (mm)	Dynamic (mm)	Metre	Article No. black	Metre	Article No. black	Metre		Article No. black
	5/16"	10,1	14,4	50	65	30	350.010.1	-	-	-	-	0,2
	3/8"	12,6	17,8	60	85	30	350.012.1	-	-	-	-	0,3
	1/2"	16	21,1	75	110	30	350.016.1	-	-	-	-	0,4
	3/4"	21	26,4	90	140	30	350.020.1	-	-	-	-	0,55
	1"	26,5	33,1	120	170	30	350.026.1	-	-	-	-	0,75
	1.1/4"	35,1	41,8	150	215	15	350.035.1	-	-	-	-	1
	1.1/2"	40,3	47,8	200	250	15	350.040.1	-	-	-	-	1,55
	2"	51,6	59,9	250	300	15	350.050.1	-	-	-	-	2,15

SEALTITE	1/4"	5/16"	3/8"	1/2"	3/4"	1"	1.1/4"	1.1/2"	2"	2.1/2"	3"	4"
ISO	M10 - M12	M16 - M20	M16 - M20	M20	M25	M32	M40	M50 - M63	M50 - M63	M75	M90	-
PG	7	09 - 11	11 - 13,5	16	21	29	36	42	48	-	-	-
NPT	-	-	1/2"	1/2"	3/4"	1"	1.1/4"	1.1/2"	2"	2.1/2"	3"	4"

# Anaconda Sealtite conduit

## TYPE HFI-316 BLUE



### ROBUST, HALOGEN-FREE, VERY FLEXIBLE, CHEMICAL RESISTANT, FLAME RETARDANT AND SUPERIOR CORROSION RESISTANT

Type HFI-316 Blue is a robust conduit with a AISI-316 stainless steel core and a thick, smooth TPU cover that is highly chemical resistant, halogen-free and flame retardant in compliance with European environmental health and safety guidelines. The conduit retains its flexibility at both high and low temperatures and is superior corrosion resistant. Type HFI-316 Blue is suitable for the mechanical protection of sensitive cables and wires in hazardous areas, including low energy ATEX Ex i applications in the oil and gas, chemical and petro-chemical, food processing, pharmaceutical and shipbuilding industries.

#### Material & Construction:

**Construction:** Stainless steel (AISI-316) core, square locked with cord packing, thick smooth Thermoplastic Poly-Urethane (TPU component) cover.

**Cover specifications:** Poly-Urethane, lead-free according to RoHS, sunlight and UV resistant,

suitable for outside installation. The cover is resistant against oil, grease and chemicals.

**Temperature:** -55 °C till +105 °C, intermittent up to +125 °C.

**Colour:** Blue (subject to minimum order quantities also available in black).

#### Classification according to NEN-EN-IEC 61386:

**Compression resistance:** Class 4 Heavy (1250N).

**Impact resistance:** Class 4 Heavy (6 J).

**Tensile strength:** Class 4 Heavy (1000N).

**Protection class:** IP 66 / 67 (dustproof, watertight).



Square locked from 3/8" - 1"

SEALTITE	DIAMETRE		BENDING RADIUS (CL)		STANDARD CARTON		SMALL CARTON		REEL		WEIGHT (kg/m)
	Size (inch)	Inside (mm)	Outside (mm)	Static (mm)	Dynamic (mm)	Metre	Article No. blue	Metre	Article No. blue	Metre	
3/8"	12,6	17,8	60	85	30	339.412.1	-	-	-	-	0,3
1/2"	16	21,1	75	110	30	339.416.1	-	-	-	-	0,4
3/4"	21	26,4	90	140	30	339.420.1	-	-	-	-	0,5
1"	26,5	33,1	120	170	30	339.426.1	-	-	-	-	0,7

SEALTITE	1/4"	5/16"	3/8"	1/2"	3/4"	1"	1.1/4"	1.1/2"	2"	2.1/2"	3"	4"
ISO	M10 - M12	M16 - M20	M16 - M20	M20	M25	M32	M40	M50 - M63	M50 - M63	M75	M90	-
PG	7	9 - 11	11 - 13,5	16	21	29	36	42	48	-	-	-
NPT	-	-	1/2"	1/2"	3/4"	1"	1.1/4"	1.1/2"	2"	2.1/2"	3"	4"

# Anaconda Sealtite conduit

## TYPE HCI-316 BLACK



### ROBUST, WIDE TEMPERATURE RANGE AND SUPERIOR CORROSION RESISTANT

Type HCI-316 is a very robust conduit with a superior corrosion resistant AISI-316 stainless steel core and a thick, smooth PVC cover that is suitable for use in very low and very high temperature applications. This very robust conduit is designed for use in applications where mechanical, corrosion and thermal protection of cables installed on equipment and installations in coastal, offshore and other demanding locations where conditions can be extreme. Other areas of application include equipment, machines, control boxes and enclosures in the food, foundry, chemical and ceramic industries.

#### Material & Construction:

**Construction:** Stainless steel (AISI-316), square locked with cord packing, thick smooth thermoplastic cover (PVC component).

**Cover specifications:** PVC, lead-free according to RoHS, sunlight and UV resistant, suitable for

outside installation. The cover provides good resistance to oil and grease.

**Temperature:** -45 °C till +105 °C, intermittent up to +120 °C.

**Colour:** Black.

#### Classification according to NEN-EN-IEC 61386:

**Compression resistance:** Class 4, Heavy (1250 N).

**Impact resistance:** Class 4, Heavy (6 J).

**Tensile strength:** Class 4, Heavy (1000 N).

**Protection class:** IP 66 / 67 (dustproof, watertight).



Square locked from 3/8" - 1"

Atex fittings

SEALTITE	DIAMETRE		BENDING RADIUS (CL)		STANDARD CARTON		SMALL CARTON		REEL		WEIGHT (kg/m)	
	Size (inch)	Inside (mm)	Outside (mm)	Static (mm)	Dynamic (mm)	Metre	Article No. black	Metre	Article No. black	Metre		Article No. black
	3/8"	12,6	17,8	60	85	30	319.012.1	10	319.012.3	-	-	0,30
	1/2"	16	21,1	75	110	30	319.016.1	10	319.016.3	-	-	0,40
	3/4"	21	26,4	90	140	30	319.020.1	10	319.020.3	-	-	0,55
	1"	26,5	33,1	120	170	30	319.026.1	10	319.026.3	-	-	0,75

SEALTITE	1/4"	5/16"	3/8"	1/2"	3/4"	1"	1.1/4"	1.1/2"	2"	2.1/2"	3"	4"
ISO	M10 - M12	M16 - M20	M16 - M20	M20	M25	M32	M40	M50 - M63	M50 - M63	M75	M90	-
PG	7	9 - 11	11 - 13,5	16	21	29	36	42	48	-	-	-
NPT	-	-	1/2"	1/2"	3/4"	1"	1.1/4"	1.1/2"	2"	2.1/2"	3"	4"

# Anaconda Sealtite conduit

## TYPE HCX BLACK



### ROBUST, VERY WIDE OPERATING TEMPERATURE RANGE

Type HCX is a very robust conduit that features a galvanised steel core and a thick, smooth TPE cover that is very temperature resistant. The conduit retains its functional integrity equally good when exposed to freezing and extreme hot temperatures. Robust, yet very flexible, Type HCX is used in transformers, offshore applications, steelworks, foundries, machine building and many outdoor installations where temperature and humidity are critical.

#### Material & Construction:

**Construction:** Hot dipped galvanised steel core, square-locked with cord packing, thick smooth Thermo-Plastic Elastomer (TPE compound) cover. From 1.1/2" a fully inter-locked profile will be used.

**Cover specifications:** TPE, lead-free according to RoHS, sunlight and UV resistant. Suitable for outside installation.

**Temperature:** -55 °C till +145 °C, intermittent up to +160 °C.

**Colour:** Black.



#### Classification according to NEN-EN-IEC 61386:

**Compression resistance:** Class 4, Heavy (1250 N).

**Impact resistance:** Class 4, Heavy (6 J).

**Tensile strength:** Class 4, Heavy (1000 N).

**Protection class:** IP 66 / 67 (dust-proof, water-tight).



Square locked from 3/8" - 1.1/4"



Inter locked for size 1.1/2" and 2"

SEALTITE	DIAMETRE		BENDING RADIUS (CL)		STANDARD CARTON		SMALL CARTON		REEL		WEIGHT (kg/m)	
	Size (inch)	Inside (mm)	Outside (mm)	Static (mm)	Dynamic (mm)	Metre	Article No. black	Metre	Article No. black	Metre		Article No. black
	3/8"	12,6	17,8	60	85	30	326.012.1	10	326.012.3	250	326.012.5	0,3
	1/2"	16	21,1	75	110	30	326.016.1	10	326.016.3	150	326.016.5	0,4
	3/4"	21	26,4	90	140	30	326.020.1	10	326.020.3	120	326.020.5	0,55
	1"	26,5	33,1	120	170	30	326.026.1	10	326.026.3	90	326.026.5	0,75
	1.1/4"	35,1	41,8	135	215	15	326.035.1	-	-	60	326.035.5	1
	1.1/2"	40,3	47,8	165	250	15	326.040.1	-	-	45	326.040.5	1,55
	2"	51,6	59,9	210	300	15	326.050.1	-	-	30	326.050.5	2,15

SEALTITE	1/4"	5/16"	3/8"	1/2"	3/4"	1"	1.1/4"	1.1/2"	2"	2.1/2"	3"	4"
ISO	M10 - M12	M16 - M20	M16 - M20	M20	M25	M32	M40	M50 - M63	M50 - M63	M75	M90	-
PG	7	9 - 11	11 - 13,5	16	21	29	36	42	48	-	-	-
NPT	-	-	1/2"	1/2"	3/4"	1"	1.1/4"	1.1/2"	2"	2.1/2"	3"	4"

# Anaconda Sealtite conduit

## TYPE HTDL BLACK



### ROBUST, UL AND CSA APPROVED, WIDE TEMPERATURE RANGE

Type HTDL is a robust conduit with a galvanised steel core and a thick, smooth PVC cover. An integral grounding copper wire (till 1.1/4") provides EMI / EMP shielding for cables that require electromagnetic protection. Type HTDL is UL and CSA approved and is used to protect cables on machines, equipment, enclosures and installations exported to countries outside, but also inside Europe. The conduit is used on transformers, paper-recycling machinery, internal transport systems, air-traffic-control systems, UMTS systems, oil and gas installations as well as the apparatus-building industry and equipment in hazardous areas.

#### Material & Construction:

**Construction:** Galvanised steel core, square locked with integral copper grounding wire till 1.1/4", thick smooth thermoplastic cover (PVC component).

**Cover specifications:** PVC (lead-free acc. to RoHS), sunlight and UV resistant, suitable for outside installation. The cover offers good resistance to oil and grease.

**Special approvals:** UL-360 (file # E18917) and CSA C 22.2 (file # 63790 / 158897). Applicable for NEC Article 250.118 (6), 350, 300.22 (D), 620.21 and 645.5 (E) (2).

Suitable for use in hazardous environments according to NEC:

- Article 501.10 (B) (2) Class I, Division 2
- Article 502.10 (A) (2) and (B) (2) Class II, Division 1 and 2
- Article 503.10 (A) (3) and (B) Class III, Division 1 and 2.

**Temperature:** -45 °C till +105 °C, intermittent up to +120 °C.

Max. temperature according CSA is +75 °C.

**Colour:** Black.

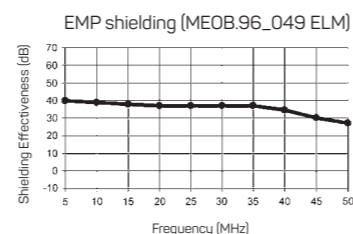

Square locked from 3/8" - 1.1/4"



Interlocked for size 1.1/2" - 4"

Atex fittings

SEALTITE	DIAMETRE		BENDING RADIUS (CL)		STANDARD CARTON		SMALL CARTON		REEL		WEIGHT (kg/m)
	Size (inch)	Inside (mm)	Outside (mm)	Static (mm)	Dynamic (mm)	Metre	Article No. black	Metre	Article No. black	Metre	
3/8"	12,6	17,8	70	85	60	330.012.2	10	330.012.3	150	330.012.5	0,4
1/2"	16,1	21,1	90	110	60	330.016.2	10	330.016.3	150	330.016.5	0,45
3/4"	21,1	26,4	115	140	45	330.020.2	10	330.020.3	120	330.020.5	0,65
1"	26,8	33,1	145	170	30	330.026.1	10	330.026.3	150	330.026.5	1,05
1.1/4"	35,4	41,8	175	215	15	330.035.1	-	-	60	330.035.5	1,2
1.1/2"	40,3	47,8	205	250	15	330.040.1	-	-	45	330.040.5	1,5
2"	51,6	59,9	240	300	15	330.050.1	-	-	30	330.050.5	2,3
2.1/2"	63,3	72,6	280	375	15	330.063.1	-	-	-	-	2,8
3"	78,4	88,4	425	530	7,5	330.075.1	-	-	-	-	3,7

SEALTITE	1/4"	5/16"	3/8"	1/2"	3/4"	1"	1.1/4"	1.1/2"	2"	2.1/2"	3"	4"
ISO	M10 - M12	M16 - M20	M16 - M20	M20	M25	M32	M40	M50 - M63	M50 - M63	M75	M90	-
PG	7	9 - 11	11 - 13,5	16	21	29	36	42	48	-	-	-
NPT	-	-	1/2"	1/2"	3/4"	1"	1.1/4"	1.1/2"	2"	2.1/2"	3"	4"



# Anaconda IECEx-ATEX, BXA, IP 66 / 68, nickel plated brass



## ANACONDA IECEX-ATEX BARRIER FITTING, TYPE BXA, NICKEL PLATED BRASS

Type BXA IECEx-ATEX approved nickel plated brass barrier fittings are designed for use also with a Sealtite liquid tight conduit for loose wires and unarmoured cables (stripped) in a potentially explosive atmosphere. The barrier is made by mixing a 2 component epoxy resin which is supplied standard with each individual fitting. Typical applications include motors, transformers, control equipment, Ex enclosures, terminal boxes and instruments in the chemical and petrochemical, oil and gas, bulk handling, wood processing and food and pharma industries. In case a 45° or 90° solution is needed it is possible to use the IECEx-ATEX barrier Anaconda swivel adapter type BXC in combination with a 45° or 90° Anaconda fitting.

### Material & Construction:

**Construction:** Nickel plated brass fitting, consisting of 5 parts (counter nut, clamping ring, ferrule, barrier container and body). Separately, a 2 component epoxy resin is supplied for creating the barrier.

**Material:** Counter nut, ferrule, barrier container and body are nickel plated brass, clamping ring is PTFE, O-rings are silicone.

Also available in stainless steel AISI-316.

Fittings are fully RoHS compliant.

**Temperature:** -60 °C till +130 °C continuous.

**Protection class:** IP 67 on the conduit and IP 66 between body and switchbox. IP 68 can be obtained with a flat seal between body and switchbox.

**Colour:** Metal coloured.

For loose wires and unarmoured cables (stripped), IECEx-ATEX certified and marked;  
 ▲ RCN (type) (thread size) IECEx CES 15.0001X Ex db / eb I Mb IIC Gb Ex tb IIIC Db  
 ⚡ CE 0080 CESI 14ATEX069X I M2 / II 2 GD, IP 66 / IP 68

BXA, ISO, Explosion proof IECEx-ATEX barrier fitting, nickel plated brass, epoxy barrier type (-60 °C till +130 °C)

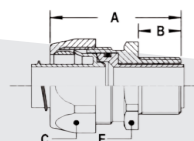

THREAD ISO	SEALTITE SIZE (INCH)	MIN. INTERNAL BORE (MM)	DIMENSIONS IN MM					STANDARD PACKAGE	ARTICLE NUMBER	WEIGHT (KG/100)
			A	B	C	E	F			
M16 x 1,5	3/8"	10,4	44	15	26	25	-	10	836.016.0*	8,5
M20 x 1,5	1/2"	13,8	46	15	30	28	-	10	836.020.0	11
M25 x 1,5	3/4"	18,5	47	15	35	34	-	5	836.025.0	14,9
M32 x 1,5	1"	23,8	48	15	45	43	-	5	836.032.0	24,6
M40 x 1,5	1.1/4"	31,9	53	15	55	52	-	2	836.040.0	36,7

\* Size M16 - 3/8" is not admitted for Group I (Mining) applications.

BXA, NPT, Explosion proof IECEx-ATEX barrier fitting, nickel plated brass, epoxy barrier type (-60 °C till +130 °C)

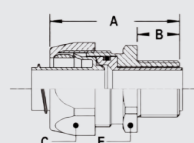

THREAD NPT	SEALTITE SIZE (INCH)	MIN. INTERNAL BORE (MM)	DIMENSIONS IN MM					STANDARD PACKAGE	ARTICLE NUMBER	WEIGHT (KG/100)
			A	B	C	E	F			
NPT 1/2"	3/8"	10,4	49	20	26	25	-	10	837.012.0	10
NPT 1/2"	1/2"	13,8	51	20	30	28	-	10	837.016.0	12,1
NPT 3/4"	3/4"	18,5	53	21	35	34	-	5	837.020.0	15,7
NPT 1"	1"	23,8	58	25	45	43	-	5	837.026.0	27,7
NPT 1.1/4"	1.1/4"	31,9	64	26	55	52	-	2	837.035.0	41,3

# Anaconda IECEx-ATEX, BXA-316, IP 66 / 68, stainless steel



## ANACONDA IECEx-ATEX BARRIER FITTING, TYPE BXA-316, STAINLESS STEEL AISI-316

Type BXA-316 IECEx-ATEX approved stainless steel barrier fitting is designed for use also with a Sealrite liquid tight conduit for loose wires and unarmoured cables (stripped) in a potentially explosive atmosphere. The use of stainless steel AISI-316 material ensures resistance to corrosive chemicals. The barrier is formed by mixing a 2 component epoxy resin which is supplied standard with each individual fitting. Typical applications include motors, transformers, control equipment, Ex enclosures, terminal boxes and components etc., in the chemical and petrochemical, oil and gas, bulk handling, wood processing and food and pharma industries. In case a 45° or 90° solution is needed it is possible to use the IECEx-ATEX barrier Anaconda swivel adapter, type BXC AISI-316, in combination with a 45° or 90° Anaconda fitting.

### Material & Construction:

**Construction:** Stainless steel AISI-316 fitting, consisting of 5 parts (counter nut, clamping ring, ferrule, barrier container and body). Separately, a 2 component epoxy resin is supplied for creating the barrier.

**Material:** Counter nut and body are stainless steel AISI-316, the barrier container and ferrule are nickel plated brass and the clamping ring is from PTFE.

Fittings are fully RoHS compliant.

**Temperature:** -60 °C till +130 °C continuous.

**Protection class:** IP 67 on the conduit and IP 66 between body and switchbox. IP 68 can be obtained with a flat seal between body and switchbox.

**Colour:** Metal coloured.

For loose wires and unarmoured cables (stripped), IECEx-ATEX certified and marked;  
 ▲ RCN (type) (thread size) IECEx CES 15.0001X Ex db / eb I Mb IIC Gb Ex tb IIIC Db  
 ⚡ CE 0080 CESI 14ATEX069X I M2 / II 2 GD, IP 66 / IP 68

BXA-316, ISO, IECEx-ATEX barrier fitting, stainless steel AISI-316, epoxy barrier type (-60 °C till +130 °C)



Atex fittings

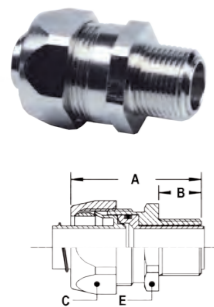

THREAD ISO	SEALTITE SIZE (INCH)	MIN. INTERNAL BORE (MM)	DIMENSIONS IN MM					STANDARD PACKAGE	ARTICLE NUMBER	WEIGHT (KG/100)
			A	B	C	E	F			
M16 x 1,5	3/8"	10,4	44	15	26	25	-	10	836.016.9*	8
M20 x 1,5	1/2"	13,8	46	15	30	28	-	10	836.020.9	10,4
M25 x 1,5	3/4"	18,5	47	15	35	34	-	5	836.025.9	14
M32 x 1,5	1"	23,8	48	15	45	43	-	5	836.032.9	23,2
M40 x 1,5	1.1/4"	31,9	53	15	55	52	-	2	836.040.9	34,7

\* Size M16 - 3/8" is not admitted for Group I (Mining) applications.

BXA-316, NPT, IECEx-ATEX barrier fitting, stainless steel AISI-316, epoxy barrier type (-60 °C till +130 °C)

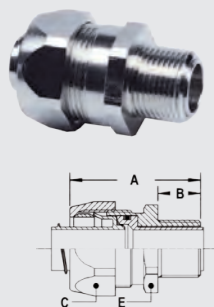

THREAD NPT	SEALTITE SIZE (INCH)	MIN. INTERNAL BORE (MM)	DIMENSIONS IN MM					STANDARD PACKAGE	ARTICLE NUMBER	WEIGHT (KG/100)
			A	B	C	E	F			
NPT 1/2"	3/8"	10,4	49	20	26	25	-	10	837.012.9	9,4
NPT 1/2"	1/2"	13,8	51	20	30	28	-	10	837.016.9	11,5
NPT 3/4"	3/4"	18,5	53	21	35	34	-	5	837.020.9	14,9
NPT 1"	1"	23,8	58	25	45	43	-	5	837.026.9	26,1
NPT 1.1/4"	1.1/4"	31,9	64	26	55	52	-	2	837.035.9	39

# Anaconda IECEx-ATEX, RNA, IP 66 / 68, nickel plated brass



## ANACONDA IECEx-ATEX CABLE-HOSE FITTING TYPE RNA AND RAA, NICKEL PLATED BRASS

Type RNA IECEx-ATEX approved nickel plated brass cable-hose fittings are designed for use also with Anaconda Sealrite liquid tight conduits to connect and protect a single unarmoured cable (single core or multicore) in a potentially explosive atmosphere. A special designed connection set enables the fitting to be used also with the Anaconda Multiflex range of uncovered conduits. Typical applications include motors, transformers, control equipment, Ex enclosures, terminal boxes, components etc, in the chemical and petrochemical, oil and gas, bulk handling, wood processing and food and pharma industries. Also available in a version for armoured cable type RAA (see pages 7 - 16 till 7 - 17). In case a 45° or 90° solution is needed it is possible to use the IECEx-ATEX Anaconda adapter type RNC and RAC in combination with a 45° or 90° Anaconda nickel plated brass swivel fitting.

### Material & Construction:

**Construction:** Nickel plated brass fitting, consisting of 7 parts (counter nut, clamping ring, ferrule, intermediate housing, pressure ring, sealing rubber and body). Also available as barrier version with resin sealing (type BNA and BAA).  
**Material:** Counter nut, intermediate housing, pressure ring and body are nickel plated brass. Ferrule is from galvanized steel, sealing rubber is from EPDM, clamping ring is from PA6.

Also available in stainless steel AISI-316. Fittings are fully RoHS compliant.  
**Temperature:** -40 °C till +100 °C continuous. With silicone sealing rubber -65 °C till +220 °C continuous.  
**Protection class:** IP 67 on the conduit and standard IP 66 between body and switchbox, with a flat seal between body and switchbox IP 68.  
**Colour:** Metal coloured.

For unarmoured cable, IECEx-ATEX certified and marked;  
 ▲ RCN (type) (thread size) IECEx INE 10.0010X Ex d/e I Mb IIC Gb Ex tb IIIC Db  
 ⚡ CE 0080 INERIS 06ATEX0014X I M2 / II 2 GD, IP 66 / IP 68

RNA, ISO, IECEx-ATEX cable-hose fitting, nickel plated brass, EPDM seal (-40 °C till +100 °C)

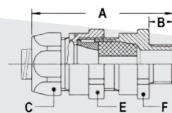

THREAD ISO	SEALTITE SIZE (INCH)	CLAMPING RANGE (MM)	DIMENSIONS IN MM					STANDARD PACKAGE	ARTICLE NUMBER	WEIGHT (KG/100)
			A	B	C	E	F			
M16 x 1,5	5/16"	4 - 7	71	15	26	25	24	10	822.006.0	10,8
M20 x 1,5	5/16"	4 - 7	71	15	26	25	24	10	822.007.0	10,8
M16 x 1,5	3/8"	4 - 7	71	15	26	25	24	10	822.010.0	10,8
M16 x 1,5	3/8"	7 - 10	71	15	26	25	24	10	822.011.0	10,8
M20 x 1,5	3/8"	4 - 7	71	15	26	25	24	10	822.008.0	10,8
M20 x 1,5	3/8"	7 - 10	71	15	26	25	24	10	822.009.0	10,8
M20 x 1,5	1/2"	5,5 - 8	74	15	30	32	30	10	822.012.0	17,8
M20 x 1,5	1/2"	8 - 10,5	74	15	30	32	30	10	822.013.0	17,8
M20 x 1,5	1/2"	10,5 - 13	74	15	30	32	30	10	822.014.0	17,8
M25 x 1,5	3/4"	10,5 - 13	74	15	35	36	35	5	822.015.0	21,6
M25 x 1,5	3/4"	13 - 15,5	74	15	35	36	35	5	822.018.0	21,6
M25 x 1,5	3/4"	15,5 - 18	74	15	35	36	35	5	822.019.0	21,6
M32 x 1,5	1"	15 - 18	90	15	45	45	42	5	822.023.0	38
M32 x 1,5	1"	18 - 21	90	15	45	45	42	5	822.024.0	38
M32 x 1,5	1"	21 - 23,5	90	15	45	45	42	5	822.025.0	38
M40 x 1,5	1.1/4"	21 - 24	94	15	55	55	48	2	822.029.0	45,1
M40 x 1,5	1.1/4"	24 - 27	94	15	55	55	48	2	822.030.0	45,1
M40 x 1,5	1.1/4"	27 - 30	94	15	55	55	48	2	822.031.0	45,1

## ANACONDA IECEX-ATEX, RNA, IP 66 / 68, NICKEL PLATED BRASS

For unarmoured cable, IECEX-ATEX certified and marked;

▲ RCN (type) (thread size) IECEX INE 10.0010X Ex d/e I Mb IIC Gb Ex tb IIIC Db

CE 0080 INERIS 06ATEX0014X I M2 / II 2 GD, IP 66 / IP 68

RNA, NPT, IECEX-ATEX cable-hose fitting, nickel plated brass,  
EPDM seal (-40 °C till +100 °C)

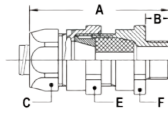

THREAD NPT	SEALTITE SIZE (INCH)	CLAMPING RANGE (MM)	DIMENSIONS IN MM					STANDARD PACKAGE	ARTICLE NUMBER	WEIGHT (KG/100)
			A	B	C	E	F			
NPT 1/2"	5/16"	4 - 7	74	18	26	25	24	10	824.008.0	10,8
NPT 1/2"	3/8"	4 - 7	74	18	26	25	24	10	824.010.0	10,8
NPT 1/2"	3/8"	7 - 10	74	18	26	25	24	10	824.011.0	10,8
NPT 1/2"	1/2"	5,5 - 8	77	18	30	32	30	10	824.012.0	17,8
NPT 1/2"	1/2"	8 - 10,5	77	18	30	32	30	10	824.013.0	17,8
NPT 1/2"	1/2"	10,5 - 13	77	18	30	32	30	10	824.014.0	17,8
NPT 3/4"	3/4"	10,5 - 13	77	18	35	36	35	5	824.015.0	21,6
NPT 3/4"	3/4"	13 - 15,5	77	18	35	36	35	5	824.018.0	21,6
NPT 3/4"	3/4"	15,5 - 18	77	18	35	36	35	5	824.019.0	21,6
NPT 1"	1"	15 - 18	97	22	45	45	42	5	824.023.0	38
NPT 1"	1"	18 - 21	97	22	45	45	42	5	824.024.0	38
NPT 1"	1"	21 - 23,5	97	22	45	45	42	5	824.025.0	38

RNA, ISO, IECEX-ATEX cable-hose fitting, nickel plated brass,  
silicone seal (-65 °C till +220 °C)



Atex  
fittings

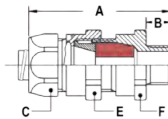

THREAD ISO	SEALTITE SIZE (INCH)	CLAMPING RANGE (MM)	DIMENSIONS IN MM					STANDARD PACKAGE	ARTICLE NUMBER	WEIGHT (KG/100)
			A	B	C	E	F			
M16 x 1,5	3/8"	6 - 8	71	15	26	25	24	10	822.010.3	10,8
M16 x 1,5	3/8"	8 - 10	71	15	26	25	24	10	822.011.3	10,8
M20 x 1,5	3/8"	8 - 10	71	15	26	25	24	10	822.009.3	10,8
M20 x 1,5	1/2"	5,5 - 8	74	15	30	32	30	10	822.012.3	17,8
M20 x 1,5	1/2"	8 - 10,5	74	15	30	32	30	10	822.013.3	17,8
M20 x 1,5	1/2"	10,5 - 13	74	15	30	32	30	10	822.014.3	17,8
M25 x 1,5	3/4"	10,5 - 13	74	15	35	36	35	5	822.015.3	21,6
M25 x 1,5	3/4"	13 - 15,5	74	15	35	36	35	5	822.018.3	21,6
M25 x 1,5	3/4"	15,5 - 18	74	15	35	36	35	5	822.019.3	21,6
M32 x 1,5	1"	15 - 18	90	15	45	45	42	5	822.023.3	38
M32 x 1,5	1"	18 - 21	90	15	45	45	42	5	822.024.3	38
M32 x 1,5	1"	21 - 23,5	90	15	45	45	42	5	822.025.3	38
M40 x 1,5	1.1/4"	21 - 24	94	15	55	55	48	2	822.029.3	45,1
M40 x 1,5	1.1/4"	24 - 27	94	15	55	55	48	2	822.030.3	45,1
M40 x 1,5	1.1/4"	27 - 30	94	15	55	55	48	2	822.031.3	45,1

## ANACONDA IECEX-ATEX, RNA, IP 66 / 68, NICKEL PLATED BRASS

RNA, NPT, IECEX-ATEX cable-hose fitting, nickel plated brass,  
silicone seal (-65 °C till +220 °C)

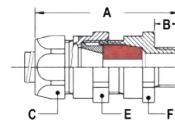

THREAD NPT	SEALTITE SIZE (INCH)	CLAMPING RANGE (MM)	DIMENSIONS IN MM					STANDARD PACKAGE	ARTICLE NUMBER	WEIGHT (KG/100)
			A	B	C	E	F			
NPT 1/2"	3/8"	6 - 8	74	18	26	25	24	10	824.010.3	10,8
NPT 1/2"	3/8"	8 - 10	74	18	26	25	24	10	824.011.3	10,8
NPT 1/2"	1/2"	5,5 - 8	77	18	30	32	30	10	824.012.3	17,8
NPT 1/2"	1/2"	8 - 10,5	77	18	30	32	30	10	824.013.3	17,8
NPT 1/2"	1/2"	10,5 - 13	77	18	30	32	30	10	824.014.3	17,8
NPT 3/4"	3/4"	10,5 - 13	77	18	35	36	35	5	824.015.3	21,6
NPT 3/4"	3/4"	13 - 15,5	77	18	35	36	35	5	824.018.3	21,6
NPT 3/4"	3/4"	15,5 - 18	77	18	35	36	35	5	824.019.3	21,6
NPT 1"	1"	15 - 18	97	22	45	45	42	5	824.023.3	38
NPT 1"	1"	18 - 21	97	22	45	45	42	5	824.024.3	38
NPT 1"	1"	21 - 23,5	97	22	45	45	42	5	824.025.3	38

# Anaconda IECEx-ATEX, RAA, IP 66 / 68, nickel plated brass

For armoured cable, IECEx-ATEX certified and marked;

▲ RCN (type) (thread size) IECEx INE 10.0010X Ex d/e I Mb IIC Gb Ex tb IIIC Db

CE 0080 INERIS 06ATEX0014X I M2 / II 2 GD, IP 66 / IP 68



RAA, ISO, IECEx-ATEX, EMC cable-hose fitting, nickel plated brass,  
EPDM seal (-40 °C till +100 °C)

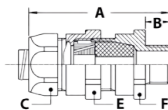

THREAD ISO	SEALTITE SIZE (INCH)	CLAMPING RANGE (MM)	DIMENSIONS IN MM					STANDARD PACKAGE	ARTICLE NUMBER	WEIGHT (KG/100)
			A	B	C	E	F			
M16 x 1,5	5/16"	4 - 7	71	15	26	25	24	10	822.206.0	10,8
M20 x 1,5	5/16"	4 - 7	71	15	26	25	24	10	822.207.0	10,8
M16 x 1,5	3/8"	4 - 7	71	15	26	25	24	10	822.210.0	10,8
M16 x 1,5	3/8"	7 - 10	71	15	26	25	24	10	822.211.0	10,8
M20 x 1,5	3/8"	7 - 10	71	15	26	25	24	10	822.209.0	10,8
M20 x 1,5	1/2"	5,5 - 8	74	15	30	32	30	10	822.212.0	17,8
M20 x 1,5	1/2"	8 - 10,5	74	15	30	32	30	10	822.213.0	17,8
M20 x 1,5	1/2"	10,5 - 13	74	15	30	32	30	10	822.214.0	17,8
M25 x 1,5	3/4"	10,5 - 13	74	15	35	36	35	5	822.215.0	21,6
M25 x 1,5	3/4"	13 - 15,5	74	15	35	36	35	5	822.218.0	21,6
M25 x 1,5	3/4"	15,5 - 18	74	15	35	36	35	5	822.219.0	21,6
M32 x 1,5	1"	15 - 18	90	15	45	45	42	5	822.223.0	38
M32 x 1,5	1"	18 - 21	90	15	45	45	42	5	822.224.0	38
M32 x 1,5	1"	21 - 23,5	90	15	45	45	42	5	822.225.0	38
M40 x 1,5	1.1/4"	21 - 24	94	15	55	55	48	2	822.229.0	45,1
M40 x 1,5	1.1/4"	24 - 27	94	15	55	55	48	2	822.230.0	45,1
M40 x 1,5	1.1/4"	27 - 30	94	15	55	55	48	2	822.231.0	45,1

Atex fittings

RAA, NPT, IECEx-ATEX, EMC cable-hose fitting, nickel plated brass,  
EPDM seal (-40 °C till +100 °C)

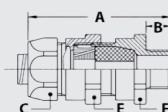

THREAD NPT	SEALTITE SIZE (INCH)	CLAMPING RANGE (MM)	DIMENSIONS IN MM					STANDARD PACKAGE	ARTICLE NUMBER	WEIGHT (KG/100)
			A	B	C	E	F			
NPT 1/2"	3/8"	4 - 7	74	18	26	25	24	10	824.210.0	10,8
NPT 1/2"	3/8"	7 - 10	74	18	26	25	24	10	824.211.0	10,8
NPT 1/2"	1/2"	5,5 - 8	77	18	30	32	30	10	824.212.0	17,8
NPT 1/2"	1/2"	8 - 10,5	77	18	30	32	30	10	824.213.0	17,8
NPT 1/2"	1/2"	10,5 - 13	77	18	30	32	30	10	824.214.0	17,8
NPT 3/4"	3/4"	10,5 - 13	77	18	35	36	35	5	824.215.0	21,6
NPT 3/4"	3/4"	13 - 15,5	77	18	35	36	35	5	824.218.0	21,6
NPT 3/4"	3/4"	15,5 - 18	77	18	35	36	35	5	824.219.0	21,6
NPT 1"	1"	15 - 18	97	22	45	45	42	5	824.223.0	38
NPT 1"	1"	18 - 21	97	22	45	45	42	5	824.224.0	38
NPT 1"	1"	21 - 23,5	97	22	45	45	42	5	824.225.0	38



## ANACONDA IECEX-ATEX, RAA, IP 66 / 68, NICKEL PLATED BRASS

For armoured cable, IECEX-ATEX certified and marked;   
 RCN (type) (thread size) IECEX INE 10.0010X Ex d/e I Mb IIC Gb Ex tb IIIC Db  
 0080 INERIS 06ATEX0014X I M2 / II 2 GD, IP 66 / IP 68

RAA, ISO, IECEX-ATEX, EMC cable-hose fitting, nickel plated brass,  
 silicone seal (-65 °C till +220 °C)

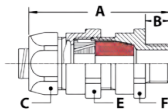

THREAD ISO	SEALTITE SIZE (INCH)	CLAMPING RANGE (MM)	DIMENSIONS IN MM					STANDARD PACKAGE	ARTICLE NUMBER	WEIGHT (KG/100)
			A	B	C	E	F			
M16 x 1,5	3/8"	6 - 8	71	15	26	25	24	10	822.210.3	10,8
M16 x 1,5	3/8"	8 - 10	71	15	26	25	24	10	822.211.3	10,8
M20 x 1,5	3/8"	8 - 10	71	15	26	25	24	10	822.209.3	10,8
M20 x 1,5	1/2"	5,5 - 8	74	15	30	32	30	10	822.212.3	17,8
M20 x 1,5	1/2"	8 - 10,5	74	15	30	32	30	10	822.213.3	17,8
M20 x 1,5	1/2"	10,5 - 13	74	15	30	32	30	10	822.214.3	17,8
M25 x 1,5	3/4"	10,5 - 13	74	15	35	36	35	5	822.215.3	21,6
M25 x 1,5	3/4"	13 - 15,5	74	15	35	36	35	5	822.218.3	21,6
M25 x 1,5	3/4"	15,5 - 18	74	15	35	36	35	5	822.219.3	21,6
M32 x 1,5	1"	15 - 18	90	15	45	45	42	5	822.223.3	38
M32 x 1,5	1"	18 - 21	90	15	45	45	42	5	822.224.3	38
M32 x 1,5	1"	21 - 23,5	90	15	45	45	42	5	822.225.3	38
M40 x 1,5	1.1/4"	21 - 24	94	15	55	55	48	2	822.229.3	45,1
M40 x 1,5	1.1/4"	24 - 27	94	15	55	55	48	2	822.230.3	45,1
M40 x 1,5	1.1/4"	27 - 30	94	15	55	55	48	2	822.231.3	45,1

RAA, NPT, IECEX-ATEX, EMC cable-hose fitting, nickel plated brass,  
 silicone seal (-65 °C till +220 °C)

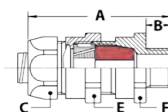

THREAD NPT	SEALTITE SIZE (INCH)	CLAMPING RANGE (MM)	DIMENSIONS IN MM					STANDARD PACKAGE	ARTICLE NUMBER	WEIGHT (KG/100)
			A	B	C	E	F			
NPT 1/2"	3/8"	6 - 8	74	18	26	25	24	10	824.210.3	10,8
NPT 1/2"	3/8"	8 - 10	74	18	26	25	24	10	824.211.3	10,8
NPT 1/2"	1/2"	5,5 - 8	77	18	30	32	30	10	824.212.3	17,8
NPT 1/2"	1/2"	8 - 10,5	77	18	30	32	30	10	824.213.3	17,8
NPT 1/2"	1/2"	10,5 - 13	77	18	30	32	30	10	824.214.3	17,8
NPT 3/4"	3/4"	10,5 - 13	77	18	35	36	35	5	824.215.3	21,6
NPT 3/4"	3/4"	13 - 15,5	77	18	35	36	35	5	824.218.3	21,6
NPT 3/4"	3/4"	15,5 - 18	77	18	35	36	35	5	824.219.3	21,6
NPT 1"	1"	15 - 18	97	22	45	45	42	5	824.223.3	38
NPT 1"	1"	18 - 21	97	22	45	45	42	5	824.224.3	38
NPT 1"	1"	21 - 23,5	97	22	45	45	42	5	824.225.3	38

### Special information for EMC cable-hose fittings

1. In case of EMC versions, the cable diameter needed to determine the clamping range, is not the outer diameter of the cable but the diameter of the cable without the braiding.
2. In case of EMC versions with a wire diameter (S) from 1,0 till 2,5 mm (type SWA, Steel Wire Armour) a special version with reduced cone clamping rings must be ordered (article no. with suffix "-RC").

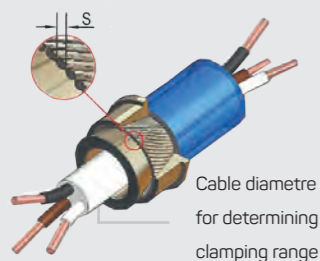

# Anaconda IECEX-ATEX, RNA-316, IP 66 / 68, stainless steel



## ANACONDA IECEX-ATEX CABLE-HOSE FITTING TYPE RNA-316 AND RAA-316, STAINLESS STEEL AISI-316

Types RNA-316 IECEX-ATEX approved stainless steel type cable-hose fittings are designed for use with Anaconda Sealtite liquid tight conduits to connect and protect a single unarmoured cable (single core or multicore) in a potentially explosive atmosphere. The use of stainless steel AISI-316 material ensures good resistance to corrosive chemicals. A special designed connection set enables the fitting also to be used with the Anaconda Multiflex range of uncovered conduits. Typical applications include motors, transformers, control equipment, Ex enclosures, terminal boxes, components etc., in the chemical and petrochemical, oil and gas, bulk handling, wood processing and food and pharma industries. Also available in a version for armoured cable type RAA-316 (see pages 7 - 22 till 7 - 23). In case a 45° or 90° solution is needed it is possible to use the IECEX-ATEX Anaconda adapter type RNC-316 and RAC-316 in combination with a 45° or 90° Anaconda stainless steel swivel fitting.

### Material & Construction:

**Construction:** Stainless steel AISI-316 fitting, consisting of 7 parts (counter nut, clamping ring, ferrule, intermediate housing, pressure ring, sealing rubber and body). Also available as barrier version with 2 component resin.

**Material:** Counter nut, intermediate housing and body are stainless steel AISI-316. Ferrule and pressure ring are nickel plated brass sealing rubber is from EPDM, clamping ring is from PA6.

Fittings are fully RoHS compliant.

**Temperature:** -40 °C till +100 °C continuous. With silicone sealing rubber -65 °C till +220 °C continuous.

**Protection class:** IP 67 on the conduit and standard IP 66 between body and switchbox, with a flat seal between body and switchbox IP 68.

**Colour:** Metal coloured.

For unarmoured cable, IECEX-ATEX certified and marked;

▲ RCN (type) (thread size) IECEX INE 10.0010X Ex d/e I Mb IIC Gb Ex tb IIIC Db

⚡ CE 0080 INERIS 06ATEX0014X I M2 / II 2 GD, IP 66 / IP 68

RNA-316, ISO, IECEX-ATEX cable-hose fitting, stainless steel AISI-316, EPDM seal (-40 °C till +100 °C)



Atex fittings

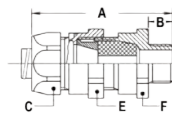

THREAD ISO	SEALTITE SIZE (INCH)	CLAMPING RANGE (MM)	DIMENSIONS IN MM					STANDARD PACKAGE	ARTICLE NUMBER	WEIGHT (KG/100)
			A	B	C	E	F			
M16 x 1,5	5/16"	4 - 7	71	15	26	25	24	10	822.006.9	10,8
M20 x 1,5	5/16"	4 - 7	71	15	26	25	24	10	822.007.9	10,8
M16 x 1,5	3/8"	4 - 7	71	15	26	25	24	10	822.010.9	10,8
M16 x 1,5	3/8"	7 - 10	71	15	26	25	24	10	822.011.9	10,8
M20 x 1,5	3/8"	4 - 7	71	15	26	25	24	10	822.008.9	10,8
M20 x 1,5	3/8"	7 - 10	71	15	26	25	24	10	822.009.9	10,8
M20 x 1,5	1/2"	5,5 - 8	74	15	30	32	30	10	822.012.9	17,8
M20 x 1,5	1/2"	8 - 10,5	74	15	30	32	30	10	822.013.9	17,8
M20 x 1,5	1/2"	10,5 - 13	74	15	30	32	30	10	822.014.9	17,8
M25 x 1,5	3/4"	10,5 - 13	74	15	35	36	36	5	822.015.9	21,6
M25 x 1,5	3/4"	13 - 15,5	74	15	35	36	36	5	822.018.9	21,6
M25 x 1,5	3/4"	15,5 - 18	74	15	35	36	36	5	822.019.9	21,6
M32 x 1,5	1"	15 - 18	90	15	45	45	42	5	822.023.9	38
M32 x 1,5	1"	18 - 21	90	15	45	45	42	5	822.024.9	38
M32 x 1,5	1"	21 - 23,5	90	15	45	45	42	5	822.025.9	38
M40 x 1,5	1.1/4"	21 - 24	94	15	55	55	48	2	822.029.9	45,1
M40 x 1,5	1.1/4"	24 - 27	94	15	55	55	48	2	822.030.9	45,1
M40 x 1,5	1.1/4"	27 - 30	94	15	55	55	48	2	822.031.9	45,1

## ANACONDA IECEX-ATEX, RNA-316, IP 66 / 68, STAINLESS STEEL

For unarmoured cable, IECEX-ATEX certified and marked;

▲ RCN (type) (thread size) IECEX INE 10.0010X Ex d/e I Mb IIC Gb Ex tb IIIC Db

CE 0080 INERIS 06ATEX0014X I M2 / II 2 GD, IP 66 / IP 68

RNA-316, NPT, IECEX-ATEX cable-hose fitting, stainless steel  
AISI-316, EPDM seal (-40 °C till +100 °C)

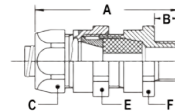

THREAD NPT	SEALTITE SIZE (INCH)	CLAMPING RANGE (MM)	DIMENSIONS IN MM					STANDARD PACKAGE	ARTICLE NUMBER	WEIGHT (KG/100)
			A	B	C	E	F			
NPT 1/2"	3/8"	4 - 7	74	18	26	25	24	10	824.010.9	10,8
NPT 1/2"	3/8"	7 - 10	74	18	26	25	24	10	824.011.9	10,8
NPT 1/2"	1/2"	5,5 - 8	77	18	30	32	30	10	824.012.9	17,8
NPT 1/2"	1/2"	8 - 10,5	77	18	30	32	30	10	824.013.9	17,8
NPT 1/2"	1/2"	10,5 - 13	77	18	30	32	30	10	824.014.9	17,8
NPT 3/4"	3/4"	10,5 - 13	77	18	35	36	36	5	824.015.9	21,6
NPT 3/4"	3/4"	13 - 15,5	77	18	35	36	36	5	824.018.9	21,6
NPT 3/4"	3/4"	15,5 - 18	77	18	35	36	36	5	824.019.9	21,6
NPT 1"	1"	15 - 18	97	22	45	45	42	5	824.023.9	38
NPT 1"	1"	18 - 21	97	22	45	45	42	5	824.024.9	38
NPT 1"	1"	21 - 23,5	97	22	45	45	42	5	824.025.9	38

RNA-316, ISO, IECEX-ATEX cable-hose fitting, stainless steel  
AISI-316, silicone seal (-65 °C till +220 °C)

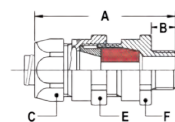

THREAD ISO	SEALTITE SIZE (INCH)	CLAMPING RANGE (MM)	DIMENSIONS IN MM					STANDARD PACKAGE	ARTICLE NUMBER	WEIGHT (KG/100)
			A	B	C	E	F			
M16 x 1,5	3/8"	6 - 8	71	15	26	25	24	10	822.010.6	10,8
M16 x 1,5	3/8"	8 - 10	71	15	26	25	24	10	822.011.6	10,8
M20 x 1,5	3/8"	8 - 10	71	15	26	25	24	10	822.009.6	10,8
M20 x 1,5	1/2"	5,5 - 8	74	15	30	32	30	10	822.012.6	17,8
M20 x 1,5	1/2"	8 - 10,5	74	15	30	32	30	10	822.013.6	17,8
M20 x 1,5	1/2"	10,5 - 13	74	15	30	32	30	10	822.014.6	17,8
M25 x 1,5	3/4"	10,5 - 13	74	15	35	36	36	5	822.015.6	21,6
M25 x 1,5	3/4"	13 - 15,5	74	15	35	36	36	5	822.018.6	21,6
M25 x 1,5	3/4"	15,5 - 18	74	15	35	36	36	5	822.019.6	21,6
M32 x 1,5	1"	15 - 18	90	15	45	45	42	5	822.023.6	38
M32 x 1,5	1"	18 - 21	90	15	45	45	42	5	822.024.6	38
M32 x 1,5	1"	21 - 23,5	90	15	45	45	42	5	822.025.6	38
M40 x 1,5	1.1/4"	21 - 24	94	15	55	55	48	2	822.029.6	45,1
M40 x 1,5	1.1/4"	24 - 27	94	15	55	55	48	2	822.030.6	45,1
M40 x 1,5	1.1/4"	27 - 30	94	15	55	55	48	2	822.031.6	45,1

## ANACONDA IECEX-ATEX, RNA-316, IP 66 / 68, STAINLESS STEEL

RNA-316, NPT, IECEX-ATEX cable-hose fitting, stainless steel  
 AISI-316, silicone seal (-65 °C till +220 °C)

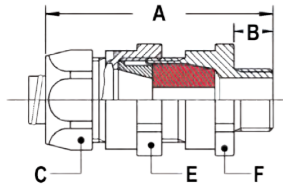

THREAD NPT	SEALTITE SIZE (INCH)	CLAMPING RANGE (MM)	DIMENSIONS IN MM					STANDARD PACKAGE	ARTICLE NUMBER	WEIGHT (KG/100)
			A	B	C	E	F			
NPT 1/2"	3/8"	6 - 8	74	18	26	25	24	10	824.010.6	10,8
NPT 1/2"	3/8"	8 - 10	74	18	26	25	24	10	824.011.6	10,8
NPT 1/2"	1/2"	5,5 - 8	77	18	30	32	30	10	824.012.6	17,8
NPT 1/2"	1/2"	8 - 10,5	77	18	30	32	30	10	824.013.6	17,8
NPT 1/2"	1/2"	10,5 - 13	77	18	30	32	30	10	824.014.6	17,8
NPT 3/4"	3/4"	10,5 - 13	77	18	35	36	36	5	824.015.6	21,6
NPT 3/4"	3/4"	13 - 15,5	77	18	35	36	36	5	824.018.6	21,6
NPT 3/4"	3/4"	15,5 - 18	77	18	35	36	36	5	824.019.6	21,6
NPT 1"	1"	15 - 18	97	22	45	45	42	5	824.023.6	38
NPT 1"	1"	18 - 21	97	22	45	45	42	5	824.024.6	38
NPT 1"	1"	21 - 23,5	97	22	45	45	42	5	824.025.6	38

Atex  
fittings

# Anaconda IECEX-ATEX, RAA-316, IP 66 / 68, stainless steel

For armoured cable, IECEX-ATEX certified and marked;

▲ RCN (type) (thread size) IECEX INE 10.0010X Ex d/e I Mb IIC Gb Ex tb IIIC Db  
 CE 0080 INERIS 06ATEX0014X I M2 / II 2 GD, IP 66 / IP 68



RAA-316, ISO, IECEX-ATEX, EMC cable-hose fitting, stainless steel AISI-316, EPDM seal (-40 °C till +100 °C)

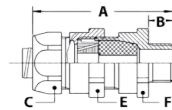

THREAD ISO	SEALTITE SIZE (INCH)	CLAMPING RANGE (MM)	DIMENSIONS IN MM					STANDARD PACKAGE	ARTICLE NUMBER	WEIGHT (KG/100)
			A	B	C	E	F			
M16 x 1,5	5/16"	4 - 7	71	15	26	25	24	10	822.206.9	10,8
M20 x 1,5	5/16"	4 - 7	71	15	26	25	24	10	822.207.9	10,8
M16 x 1,5	3/8"	4 - 7	71	15	26	25	24	10	822.210.9	10,8
M16 x 1,5	3/8"	7 - 10	71	15	26	25	24	10	822.211.9	10,8
M20 x 1,5	3/8"	7 - 10	71	15	26	25	24	10	822.209.9	10,8
M20 x 1,5	1/2"	5,5 - 8	74	15	30	32	30	10	822.212.9	17,8
M20 x 1,5	1/2"	8 - 10,5	74	15	30	32	30	10	822.213.9	17,8
M20 x 1,5	1/2"	10,5 - 13	74	15	30	32	30	10	822.214.9	17,8
M25 x 1,5	3/4"	10,5 - 13	74	15	35	36	36	5	822.215.9	21,6
M25 x 1,5	3/4"	13 - 15,5	74	15	35	36	36	5	822.218.9	21,6
M25 x 1,5	3/4"	15,5 - 18	74	15	35	36	36	5	822.219.9	21,6
M32 x 1,5	1"	15 - 18	90	15	45	45	42	5	822.223.9	38
M32 x 1,5	1"	18 - 21	90	15	45	45	42	5	822.224.9	38
M32 x 1,5	1"	21 - 23,5	90	15	45	45	42	5	822.225.9	38
M40 x 1,5	1.1/4"	21 - 24	94	15	55	55	48	2	822.229.9	45,1
M40 x 1,5	1.1/4"	24 - 27	94	15	55	55	48	2	822.230.9	45,1
M40 x 1,5	1.1/4"	27 - 30	94	15	55	55	48	2	822.231.9	45,1

RAA-316, NPT, IECEX-ATEX, EMC cable-hose fitting, stainless steel AISI-316, EPDM seal (-40 °C till +100 °C)

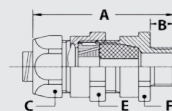

THREAD NPT	SEALTITE SIZE (INCH)	CLAMPING RANGE (MM)	DIMENSIONS IN MM					STANDARD PACKAGE	ARTICLE NUMBER	WEIGHT (KG/100)
			A	B	C	E	F			
NPT 1/2"	3/8"	4 - 7	74	18	26	25	24	10	824.210.9	10,8
NPT 1/2"	3/8"	7 - 10	74	18	26	25	24	10	824.211.9	10,8
NPT 1/2"	1/2"	5,5 - 8	77	18	30	32	30	10	824.212.9	17,8
NPT 1/2"	1/2"	8 - 10,5	77	18	30	32	30	10	824.213.9	17,8
NPT 1/2"	1/2"	10,5 - 13	77	18	30	32	30	10	824.214.9	17,8
NPT 3/4"	3/4"	10,5 - 13	77	18	35	36	36	5	824.215.9	21,6
NPT 3/4"	3/4"	13 - 15,5	77	18	35	36	36	5	824.218.9	21,6
NPT 3/4"	3/4"	15,5 - 18	77	18	35	36	36	5	824.219.9	21,6
NPT 1"	1"	15 - 18	97	22	45	45	42	5	824.223.9	38
NPT 1"	1"	18 - 21	97	22	45	45	42	5	824.224.9	38
NPT 1"	1"	21 - 23,5	97	22	45	45	42	5	824.225.9	38

## ANACONDA IECEX-ATEX, RAA-316, IP 66 / 68, STAINLESS STEEL

For armoured cable, IECEX-ATEX certified and marked;

▲ RCN (type) (thread size) IECEX INE 10.0010X Ex d/e I Mb IIC Gb Ex tb IIIC Db  
 CE 0080 INERIS 06ATEX0014X I M2 / II 2 GD, IP 66 / IP 68

RAA-316, ISO, IECEX-ATEX, EMC cable-hose fitting, stainless steel  
 AISI-316, silicone seal (-65 °C till +220 °C)

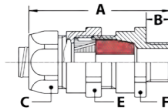

THREAD ISO	SEALTITE SIZE (INCH)	CLAMPING RANGE (MM)	DIMENSIONS IN MM					STANDARD PACKAGE	ARTICLE NUMBER	WEIGHT (KG/100)
			A	B	C	E	F			
M16 x 1,5	3/8"	6 - 8	71	15	26	25	24	10	822.210.6	10,8
M16 x 1,5	3/8"	8 - 10	71	15	26	25	24	10	822.211.6	10,8
M20 x 1,5	3/8"	8 - 10	71	15	26	25	24	10	822.209.6	10,8
M20 x 1,5	1/2"	5,5 - 8	74	15	30	32	30	10	822.212.6	17,8
M20 x 1,5	1/2"	8 - 10,5	74	15	30	32	30	10	822.213.6	17,8
M20 x 1,5	1/2"	10,5 - 13	74	15	30	32	30	10	822.214.6	17,8
M25 x 1,5	3/4"	10,5 - 13	74	15	35	36	36	5	822.215.6	21,6
M25 x 1,5	3/4"	13 - 15,5	74	15	35	36	36	5	822.218.6	21,6
M25 x 1,5	3/4"	15,5 - 18	74	15	35	36	36	5	822.219.6	21,6
M32 x 1,5	1"	15 - 18	90	15	45	45	42	5	822.223.6	38
M32 x 1,5	1"	18 - 21	90	15	45	45	42	5	822.224.6	38
M32 x 1,5	1"	21 - 23,5	90	15	45	45	42	5	822.225.6	38
M40 x 1,5	1.1/4"	21 - 24	94	15	55	55	48	2	822.229.6	45,1
M40 x 1,5	1.1/4"	24 - 27	94	15	55	55	48	2	822.230.6	45,1
M40 x 1,5	1.1/4"	27 - 30	94	15	55	55	48	2	822.231.6	45,1

RAA-316, NPT, IECEX-ATEX, EMC cable-hose fitting, stainless steel  
 AISI-316, silicone seal (-65 °C till +220 °C)

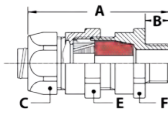

THREAD NPT	SEALTITE SIZE (INCH)	CLAMPING RANGE (MM)	DIMENSIONS IN MM					STANDARD PACKAGE	ARTICLE NUMBER	WEIGHT (KG/100)
			A	B	C	E	F			
NPT 1/2"	3/8"	6 - 8	74	18	26	25	24	10	824.210.6	10,8
NPT 1/2"	3/8"	8 - 10	74	18	26	25	24	10	824.211.6	10,8
NPT 1/2"	1/2"	5,5 - 8	77	18	30	32	30	10	824.212.6	17,8
NPT 1/2"	1/2"	8 - 10,5	77	18	30	32	30	10	824.213.6	17,8
NPT 1/2"	1/2"	10,5 - 13	77	18	30	32	30	10	824.214.6	17,8
NPT 3/4"	3/4"	10,5 - 13	77	18	35	36	36	5	824.215.6	21,6
NPT 3/4"	3/4"	13 - 15,5	77	18	35	36	36	5	824.218.6	21,6
NPT 3/4"	3/4"	15,5 - 18	77	18	35	36	36	5	824.219.6	21,6
NPT 1"	1"	15 - 18	97	22	45	45	42	5	824.223.6	38
NPT 1"	1"	18 - 21	97	22	45	45	42	5	824.224.6	38
NPT 1"	1"	21 - 23,5	97	22	45	45	42	5	824.225.6	38

Atex fittings

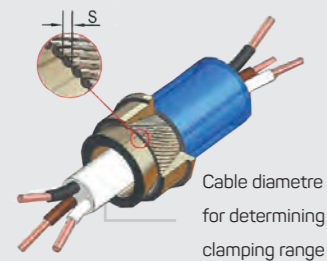

### Special information for EMC cable-hose fittings

1. In case of EMC versions, the cable diameter needed to determine the clamping range, is not the outer diameter of the cable but the diameter of the cable without the braiding.
2. In case of EMC versions with a wire diameter (S) from 1,0 till 2,5 mm (type SWA, Steel Wire Armour) a special version with reduced cone clamping rings must be ordered (article no. with suffix "-RC").



# Anaconda IECEx-ATEX, BNA, IP 66 / 68, nickel plated brass



## ANACONDA IECEx-ATEX BARRIER CABLE-HOSE FITTING TYPE BNA AND BAA, NICKEL PLATED BRASS

Type BNA IECEx-ATEX approved nickel plated brass barrier cable-hose fittings are designed for use with Anaconda Sealtite liquid tight conduits to connect and protect a single unarmoured cable (single core or multicore) in a potentially explosive atmosphere. The barrier is made by mixing a 2 component epoxy resin component which is supplied standard with each individual fitting. A special designed connection set enables the fitting to be used also with the Anaconda Multiflex range of uncovered conduits. Typical applications include connections on motors, transformers, control equipment, Ex enclosures, terminal boxes and components in the chemical and petrochemical, oil and gas, food, pharma, wood processing and bulk handling industries. Also available in a version for armoured cable type BAA (see pages 7 -27 till 7 - 28). In case a 45° or 90° solution is needed it is possible to use the IECEx-ATEX Anaconda adapter type BNC / BAC in combination with a 45° or 90° Anaconda nickel plated brass swivel fitting.

### Material & Construction:

**Construction:** Nickel plated brass fitting, consisting of 9 parts (counter nut, clamping ring, ferrule, intermediate housing, double pressure ring, sealing rubber, barrier container and body). Separately, a 2 component epoxy resin is supplied for creating the barrier.

**Material:** Counter nut, intermediate housing, pressure rings, barrier container and body are nickel plated brass, ferrule is from galvanized steel, sealing rubber is from EPDM, clamping ring is from PA6. Also

available in stainless steel AISI-316. Fittings are fully RoHS compliant.

**Temperature:** -40 °C till +100 °C continuous. With silicone sealing rubber -60 °C till +150 °C continuous.

**Protection class:** IP 67 on the conduit and standard IP 66 between body and switchbox, with a flat seal between body and switchbox IP 68.

**Colour:** Metal coloured.

For unarmoured cable, IECEx-ATEX certified and marked;

▲ RCN (type) (thread size) IECEx INE 10.0010X Ex d/e I Mb IIC Gb Ex tb IIIC Db  
 Ⓢ CE 0080 INERIS 06ATEX0014X I M2 / II 2 GD, IP 66 / IP 68

BNA, ISO, IECEx-ATEX barrier cable-hose fitting, nickel plated brass, EPDM and epoxy seal (-40 °C till +100 °C)

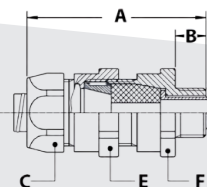

THREAD ISO	SEALTITE SIZE (INCH)	CLAMPING RANGE (MM)	DIMENSIONS IN MM					STANDARD PACKAGE	ARTICLE NUMBER	WEIGHT (KG/100)
			A	B	C	E	F			
M16 x 1,5	5/16"	4 - 7	71	15	26	25	24	10	822.106.0	10,8
M20 x 1,5	5/16"	4 - 7	71	15	26	25	24	10	822.107.0	10,8
M16 x 1,5	3/8"	4 - 7	71	15	26	25	24	10	822.110.0	10,8
M16 x 1,5	3/8"	7 - 10	71	15	26	25	24	10	822.111.0	10,8
M20 x 1,5	3/8"	4 - 7	71	15	26	25	24	10	822.108.0	10,8
M20 x 1,5	3/8"	7 - 10	71	15	26	25	24	10	822.109.0	10,8
M20 x 1,5	1/2"	5,5 - 8	74	15	30	32	30	10	822.112.0	17,8
M20 x 1,5	1/2"	8 - 10,5	74	15	30	32	30	10	822.113.0	17,8
M20 x 1,5	1/2"	10,5 - 13	74	15	30	32	30	10	822.114.0	17,8
M25 x 1,5	3/4"	10,5 - 13	74	15	35	36	35	5	822.115.0	21,6
M25 x 1,5	3/4"	13 - 15,5	74	15	35	36	35	5	822.118.0	21,6
M25 x 1,5	3/4"	15,5 - 18	74	15	35	36	35	5	822.119.0	21,6
M32 x 1,5	1"	15 - 18	90	15	45	45	42	5	822.123.0	38
M32 x 1,5	1"	18 - 21	90	15	45	45	42	5	822.124.0	38
M32 x 1,5	1"	21 - 23,5	90	15	45	45	42	5	822.125.0	38
M40 x 1,5	1.1/4"	21 - 24	94	15	55	55	48	2	822.129.0	45,1
M40 x 1,5	1.1/4"	24 - 27	94	15	55	55	48	2	822.130.0	45,1
M40 x 1,5	1.1/4"	27 - 30	94	15	55	55	48	2	822.131.0	45,1

## ANACONDA IECEX-ATEX, BNA, IP 66 / 68, NICKEL PLATED BRASS

For unarmoured cable, IECEX-ATEX certified and marked;

▲ RCN (type) (thread size) IECEX INE 10.0010X Ex d/e I Mb IIC Gb Ex tb IIIC Db

CE 0080 INERIS 06ATEX0014X I M2 / II 2 GD, IP 66 / IP 68

BNA, NPT, IECEX-ATEX barrier cable-hose fitting, nickel plated brass, EPDM and epoxy seal (-40 °C till +100 °C)

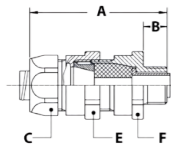

THREAD NPT	SEALTITE SIZE (INCH)	CLAMPING RANGE (MM)	DIMENSIONS IN MM					STANDARD PACKAGE	ARTICLE NUMBER	WEIGHT (KG/100)
			A	B	C	E	F			
NPT 1/2"	5/16"	4 - 7	74	18	26	25	24	10	824.108.0	10,8
NPT 1/2"	3/8"	4 - 7	74	18	26	25	24	10	824.110.0	10,8
NPT 1/2"	3/8"	7 - 10	74	18	26	25	24	10	824.111.0	10,8
NPT 1/2"	1/2"	5,5 - 8	77	18	30	32	30	10	824.112.0	17,8
NPT 1/2"	1/2"	8 - 10,5	77	18	30	32	30	10	824.113.0	17,8
NPT 1/2"	1/2"	10,5 - 13	77	18	30	32	30	10	824.114.0	17,8
NPT 3/4"	3/4"	10,5 - 13	77	18	35	36	35	5	824.115.0	21,6
NPT 3/4"	3/4"	13 - 15,5	77	18	35	36	35	5	824.118.0	21,6
NPT 3/4"	3/4"	15,5 - 18	77	18	35	36	35	5	824.119.0	21,6
NPT 1"	1"	15 - 18	97	22	45	45	42	5	824.123.0	38
NPT 1"	1"	18 - 21	97	22	45	45	42	5	824.124.0	38
NPT 1"	1"	21 - 23,5	97	22	45	45	42	5	824.125.0	38

BNA, ISO, IECEX-ATEX barrier cable-hose fitting, nickel plated brass, silicone and epoxy seal (-60 °C till +150 °C)

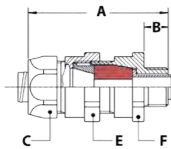

THREAD ISO	SEALTITE SIZE (INCH)	CLAMPING RANGE (MM)	DIMENSIONS IN MM					STANDARD PACKAGE	ARTICLE NUMBER	WEIGHT (KG/100)
			A	B	C	E	F			
M16 x 1,5	3/8"	6 - 8	71	15	26	25	24	10	822.110.3	10,8
M16 x 1,5	3/8"	8 - 10	71	15	26	25	24	10	822.111.3	10,8
M20 x 1,5	3/8"	8 - 10	71	15	26	25	24	10	822.109.3	10,8
M20 x 1,5	1/2"	5,5 - 8	74	15	30	32	30	10	822.112.3	17,8
M20 x 1,5	1/2"	8 - 10,5	74	15	30	32	30	10	822.113.3	17,8
M20 x 1,5	1/2"	10,5 - 13	74	15	30	32	30	10	822.114.3	17,8
M25 x 1,5	3/4"	10,5 - 13	74	15	35	36	35	5	822.115.3	21,6
M25 x 1,5	3/4"	13 - 15,5	74	15	35	36	35	5	822.118.3	21,6
M25 x 1,5	3/4"	15,5 - 18	74	15	35	36	35	5	822.119.3	21,6
M32 x 1,5	1"	15 - 18	90	15	45	45	42	5	822.123.3	38
M32 x 1,5	1"	18 - 21	90	15	45	45	42	5	822.124.3	38
M32 x 1,5	1"	21 - 23,5	90	15	45	45	42	5	822.125.3	38
M40 x 1,5	1.1/4"	21 - 24	94	15	55	55	48	2	822.129.3	45,1
M40 x 1,5	1.1/4"	24 - 27	94	15	55	55	48	2	822.130.3	45,1
M40 x 1,5	1.1/4"	27 - 30	94	15	55	55	48	2	822.131.3	45,1

Atex fittings

## ANACONDA IECEX-ATEX, BNA, IP 66 / 68, NICKEL PLATED BRASS

BNA, NPT, IECEX-ATEX barrier cable-hose fitting, nickel plated brass, silicone and epoxy seal (-60 °C till +150 °C)

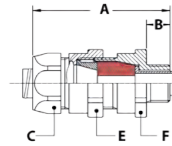

THREAD NPT	SEALTITE SIZE (INCH)	CLAMPING RANGE (MM)	DIMENSIONS IN MM					STANDARD PACKAGE	ARTICLE NUMBER	WEIGHT (KG/100)
			A	B	C	E	F			
NPT 1/2"	3/8"	6 - 8	74	18	26	25	24	10	824.110.3	10,8
NPT 1/2"	3/8"	8 - 10	74	18	26	25	24	10	824.111.3	10,8
NPT 1/2"	1/2"	5,5 - 8	77	18	30	32	30	10	824.112.3	17,8
NPT 1/2"	1/2"	8 - 10,5	77	18	30	32	30	10	824.113.3	17,8
NPT 1/2"	1/2"	10,5 - 13	77	18	30	32	30	10	824.114.3	17,8
NPT 3/4"	3/4"	10,5 - 13	77	18	35	36	35	5	824.115.3	21,6
NPT 3/4"	3/4"	13 - 15,5	77	18	35	36	35	5	824.118.3	21,6
NPT 3/4"	3/4"	15,5 - 18	77	18	35	36	35	5	824.119.3	21,6
NPT 1"	1"	15 - 18	97	22	45	45	42	5	824.123.3	38
NPT 1"	1"	18 - 21	97	22	45	45	42	5	824.124.3	38
NPT 1"	1"	21 - 23,5	97	22	45	45	42	5	824.125.3	38

# Anaconda IECEx-ATEX, BAA, IP 66 / 68, nickel plated brass

For armoured cable, IECEx-ATEX certified and marked;  
 ▲ RCN (type) (thread size) IECEx INE 10.0010X Ex d/e I Mb IIC Gb Ex tb IIIC Db  
 ⚡ CE 0080 INERIS 06ATEX0014X I M2 / II 2 GD, IP 66 / IP 68



BAA, ISO, IECEx-ATEX EMC barrier cable-hose fitting,  
 nickel plated brass, EPDM and epoxy seal (-40 °C till +100 °C)

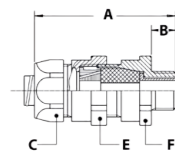

THREAD ISO	SEALTITE SIZE (INCH)	CLAMPING RANGE (MM)	DIMENSIONS IN MM					STANDARD PACKAGE	ARTICLE NUMBER	WEIGHT (KG/100)
			A	B	C	E	F			
M16 x 1,5	3/8"	4 - 7	71	15	26	25	24	10	822.310.0	10,8
M16 x 1,5	3/8"	7 - 10	71	15	26	25	24	10	822.311.0	10,8
M20 x 1,5	3/8"	4 - 7	71	15	26	25	24	10	822.308.0	10,8
M20 x 1,5	3/8"	7 - 10	71	15	26	25	24	10	822.309.0	10,8
M20 x 1,5	1/2"	5,5 - 8	74	15	30	32	30	10	822.312.0	17,8
M20 x 1,5	1/2"	8 - 10,5	74	15	30	32	30	10	822.313.0	17,8
M20 x 1,5	1/2"	10,5 - 13	74	15	30	32	30	10	822.314.0	17,8
M25 x 1,5	3/4"	10,5 - 13	74	15	35	36	35	5	822.315.0	21,6
M25 x 1,5	3/4"	13 - 15,5	74	15	35	36	35	5	822.318.0	21,6
M25 x 1,5	3/4"	15,5 - 18	74	15	35	36	35	5	822.319.0	21,6
M32 x 1,5	1"	15 - 18	90	15	45	45	42	5	822.323.0	38
M32 x 1,5	1"	18 - 21	90	15	45	45	42	5	822.324.0	38
M32 x 1,5	1"	21 - 23,5	90	15	45	45	42	5	822.325.0	38
M40 x 1,5	1 1/4"	21 - 24	94	15	55	55	48	2	822.329.0	45,1
M40 x 1,5	1 1/4"	24 - 27	94	15	55	55	48	2	822.330.0	45,1
M40 x 1,5	1 1/4"	27 - 30	94	15	55	55	48	2	822.331.0	45,1

Atex fittings

BAA, NPT, IECEx-ATEX EMC barrier cable-hose fitting,  
 nickel plated brass, EPDM and epoxy seal (-40 °C till +100 °C)

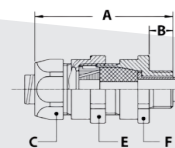

THREAD NPT	SEALTITE SIZE (INCH)	CLAMPING RANGE (MM)	DIMENSIONS IN MM					STANDARD PACKAGE	ARTICLE NUMBER	WEIGHT (KG/100)
			A	B	C	E	F			
NPT 1/2"	3/8"	4 - 7	74	18	26	25	24	10	824.310.0	10,8
NPT 1/2"	3/8"	7 - 10	74	18	26	25	24	10	824.311.0	10,8
NPT 1/2"	1/2"	5,5 - 8	77	18	30	32	30	10	824.312.0	17,8
NPT 1/2"	1/2"	8 - 10,5	77	18	30	32	30	10	824.313.0	17,8
NPT 1/2"	1/2"	10,5 - 13	77	18	30	32	30	10	824.314.0	17,8
NPT 3/4"	3/4"	10,5 - 13	77	18	35	36	35	5	824.315.0	21,6
NPT 3/4"	3/4"	13 - 15,5	77	18	35	36	35	5	824.318.0	21,6
NPT 3/4"	3/4"	15,5 - 18	77	18	35	36	35	5	824.319.0	21,6
NPT 1"	1"	15 - 18	97	22	45	45	42	5	824.323.0	38
NPT 1"	1"	18 - 21	97	22	45	45	42	5	824.324.0	38
NPT 1"	1"	21 - 23,5	97	22	45	45	42	5	824.325.0	38

## ANACONDA IECEX-ATEX, BAA, IP 66 / 68, NICKEL PLATED BRASS

For armoured cable, IECEX-ATEX certified and marked;

▲ RCN (type) (thread size) IECEX INE 10.0010X Ex d/e I Mb IIC Gb Ex tb IIIC Db  
 ⚡ CE 0080 INERIS 06ATEX0014X I M2 / II 2 GD, IP 66 / IP 68

BAA, ISO, IECEX-ATEX EMC barrier cable-hose fitting,  
 nickel plated brass, silicone and epoxy seal (-60 °C till +150 °C)

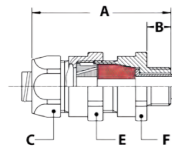

THREAD ISO	SEALTITE SIZE (INCH)	CLAMPING RANGE (MM)	DIMENSIONS IN MM					STANDARD PACKAGE	ARTICLE NUMBER	WEIGHT (KG/100)
			A	B	C	E	F			
M16 x 1,5	3/8"	6 - 8	71	15	26	25	24	10	822.310.3	10,8
M16 x 1,5	3/8"	8 - 10	71	15	26	25	24	10	822.311.3	10,8
M20 x 1,5	3/8"	8 - 10	71	15	26	25	24	10	822.309.3	10,8
M20 x 1,5	1/2"	5,5 - 8	74	15	30	32	30	10	822.312.3	17,8
M20 x 1,5	1/2"	8 - 10,5	74	15	30	32	30	10	822.313.3	17,8
M20 x 1,5	1/2"	10,5 - 13	74	15	30	32	30	10	822.314.3	17,8
M25 x 1,5	3/4"	10,5 - 13	75	15	35	36	35	5	822.315.3	21,6
M25 x 1,5	3/4"	13 - 15,5	75	15	35	36	35	5	822.318.3	21,6
M25 x 1,5	3/4"	15,5 - 18	75	15	35	36	35	5	822.319.3	21,6
M32 x 1,5	1"	15 - 18	90	15	45	45	42	5	822.323.3	38
M32 x 1,5	1"	18 - 21	90	15	45	45	42	5	822.324.3	38
M32 x 1,5	1"	21 - 23,5	90	15	45	45	42	5	822.325.3	38
M40 x 1,5	1.1/4"	21 - 24	94	15	55	55	48	2	822.329.3	45,1
M40 x 1,5	1.1/4"	24 - 27	94	15	55	55	48	2	822.330.3	45,1
M40 x 1,5	1.1/4"	27 - 30	94	15	55	55	48	2	822.331.3	45,1

BAA, NPT, IECEX-ATEX EMC barrier cable-hose fitting,  
 nickel plated brass, silicone and epoxy seal (-60 °C till +150 °C)

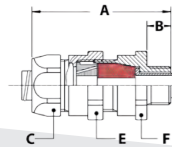

THREAD NPT	SEALTITE SIZE (INCH)	CLAMPING RANGE (MM)	DIMENSIONS IN MM					STANDARD PACKAGE	ARTICLE NUMBER	WEIGHT (KG/100)
			A	B	C	E	F			
NPT 1/2"	3/8"	6 - 8	74	18	26	25	24	10	824.310.3	10,8
NPT 1/2"	3/8"	8 - 10	74	18	26	25	24	10	824.311.3	10,8
NPT 1/2"	1/2"	5,5 - 8	77	18	30	32	30	10	824.312.3	17,8
NPT 1/2"	1/2"	8 - 10,5	77	18	30	32	30	10	824.313.3	17,8
NPT 1/2"	1/2"	10,5 - 13	77	18	30	32	30	10	824.314.3	17,8
NPT 3/4"	3/4"	10,5 - 13	77	18	35	36	35	5	824.315.3	21,6
NPT 3/4"	3/4"	13 - 15,5	77	18	35	36	35	5	824.318.3	21,6
NPT 3/4"	3/4"	15,5 - 18	77	18	35	36	35	5	824.319.3	21,6
NPT 1"	1"	15 - 18	97	22	45	45	42	5	824.323.3	38
NPT 1"	1"	18 - 21	97	22	45	45	42	5	824.324.3	38
NPT 1"	1"	21 - 23,5	97	22	45	45	42	5	824.325.3	38

### Special information for EMC cable-hose fittings

- In case of EMC versions, the cable diameter needed to determine the clamping range, is not the outer diameter of the cable but the diameter of the cable without the braiding.
- In case of EMC versions with a wire diameter (S) from 1,0 till 2,5 mm (type SWA, Steel Wire Armour) a special version with reduced cone clamping rings must be ordered (article no. with suffix "-RC").

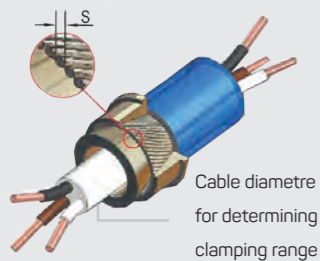

# Anaconda IECEx-ATEX, BNA-316, IP 66 / 68, stainless steel



## ANACONDA IECEx-ATEX BARRIER CABLE-HOSE FITTING TYPE BNA-316 AND BAA-316, STAINLESS STEEL AISI-316

Types BNA-316 IECEx-ATEX approved stainless steel type barrier cable-hose fittings are designed for use with Anaconda Sealite liquid tight conduits to connect and protect a single unarmoured cable (single core or multicore) in a potentially explosive atmosphere. The use of stainless steel AISI-316 material ensures good resistance to corrosive chemicals. A special designed connection set enables the fitting to be used also with the Anaconda Multiflex range of uncovered conduits. Typical applications include motors, transformers, control equipment, Ex enclosures, terminal boxes, components etc., in the chemical and petrochemical, oil and gas, bulk handling, wood processing and food and pharma industries. Also available in a version for armoured cable type BAA-316 (see pages 7 - 32 till 7 - 33). In case a 45° or 90° solution is needed it is possible to use the IECEx-ATEX Anaconda adapter type BNC-316 / BAC-316 in combination with a 45° or 90° Anaconda stainless steel swivel fitting.

### Material & Construction:

**Construction:** Stainless steel AISI-316 fitting, consisting of 9 parts (counter nut, clamping ring, ferrule, intermediate housing, double pressure ring, sealing rubber, barrier container and body). Separately, a 2 component epoxy resin is supplied for creating the barrier.

**Material:** Counter nut, intermediate housing and body are stainless steel AISI-316. Ferrule, double pressure ring and barrier container are nickel plated brass, sealing rubber is from EPDM, clamping ring is

from PA6. Fittings are fully RoHS compliant.

**Temperature:** -40 °C till +100 °C continuous. With silicone sealing rubber -65 °C till +220 °C continuous.

**Protection class:** IP 67 on the conduit and standard IP 66 between body and switchbox, with a flat seal between body and switchbox IP 68.

**Colour:** Metal coloured.

For unarmoured cable, IECEx-ATEX certified and marked;

▲ RCN (type) (thread size) IECEx INE 10.0010X Ex d/e I Mb IIC Gb Ex tb IIIC Db

Ex CE 0080 INERIS 06ATEX0014X I M2 / II 2 GD, IP 66 / IP 68

BNA-316, ISO, IECEx-ATEX barrier cable-hose fitting, stainless steel AISI-316, EPDM and epoxy seal (-40 °C till +100 °C)



Atex fittings

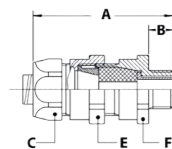

THREAD ISO	SEALITE SIZE (INCH)	CLAMPING RANGE (MM)	DIMENSIONS IN MM					STANDARD PACKAGE	ARTICLE NUMBER	WEIGHT (KG/100)
			A	B	C	E	F			
M16 x 1,5	5/16"	4 - 7	71	15	26	25	24	10	822.106.9	10,8
M20 x 1,5	5/16"	4 - 7	71	15	26	25	24	10	822.107.9	10,8
M16 x 1,5	3/8"	4 - 7	71	15	26	25	24	10	822.110.9	10,8
M16 x 1,5	3/8"	7 - 10	71	15	26	25	24	10	822.111.9	10,8
M20 x 1,5	3/8"	4 - 7	71	15	26	25	24	10	822.108.9	10,8
M20 x 1,5	3/8"	7 - 10	71	15	26	25	24	10	822.109.9	10,8
M20 x 1,5	1/2"	5,5 - 8	74	15	30	32	30	10	822.112.9	17,8
M20 x 1,5	1/2"	8 - 10,5	74	15	30	32	30	10	822.113.9	17,8
M20 x 1,5	1/2"	10,5 - 13	74	15	30	32	30	10	822.114.9	17,8
M25 x 1,5	3/4"	10,5 - 13	74	15	35	36	36	5	822.115.9	21,6
M25 x 1,5	3/4"	13 - 15,5	74	15	35	36	36	5	822.118.9	21,6
M25 x 1,5	3/4"	15,5 - 18	74	15	35	36	36	5	822.119.9	21,6
M32 x 1,5	1"	15 - 18	90	15	45	45	42	5	822.123.9	38
M32 x 1,5	1"	18 - 21	90	15	45	45	42	5	822.124.9	38
M32 x 1,5	1"	21 - 23,5	90	15	45	45	42	5	822.125.9	38
M40 x 1,5	1.1/4"	21 - 24	94	15	55	55	48	2	822.129.9	45,1
M40 x 1,5	1.1/4"	24 - 27	94	15	55	55	48	2	822.130.9	45,1
M40 x 1,5	1.1/4"	27 - 30	94	15	55	55	48	2	822.131.9	45,1



## ANACONDA IECEX-ATEX, BNA-316, IP 66 / 68, STAINLESS STEEL

For unarmoured cable, IECEX-ATEX certified and marked;

▲ RCN (type) (thread size) IECEX INE 10.0010X Ex d/e I Mb IIC Gb Ex tb IIIC Db

CE 0080 INERIS 06ATEX0014X I M2 / II 2 GD, IP 66 / IP 68

BNA-316, NPT, IECEX-ATEX barrier cable-hose fitting,  
stainless steel AISI-316, EPDM and epoxy seal (-40 °C till +100 °C)

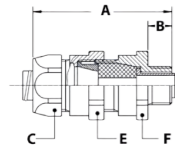

THREAD NPT	SEALTITE SIZE (INCH)	CLAMPING RANGE (MM)	DIMENSIONS IN MM					STANDARD PACKAGE	ARTICLE NUMBER	WEIGHT (KG/100)
			A	B	C	E	F			
NPT 1/2"	3/8"	4 - 7	74	18	26	25	24	10	824.110.9	10,8
NPT 1/2"	3/8"	7 - 10	74	18	26	25	24	10	824.111.9	10,8
NPT 1/2"	1/2"	5,5 - 8	77	18	30	32	30	10	824.112.9	17,8
NPT 1/2"	1/2"	8 - 10,5	77	18	30	32	30	10	824.113.9	17,8
NPT 1/2"	1/2"	10,5 - 13	77	18	30	32	30	10	824.114.9	17,8
NPT 3/4"	3/4"	10,5 - 13	77	18	35	36	36	5	824.115.9	21,6
NPT 3/4"	3/4"	13 - 15,5	77	18	35	36	36	5	824.118.9	21,6
NPT 3/4"	3/4"	15,5 - 18	77	18	35	36	36	5	824.119.9	21,6
NPT 1"	1"	15 - 18	97	22	45	45	42	5	824.123.9	38
NPT 1"	1"	18 - 21	97	22	45	45	42	5	824.124.9	38
NPT 1"	1"	21 - 23,5	97	22	45	45	42	5	824.125.9	38

BNA-316, ISO, IECEX-ATEX barrier cable-hose fitting,  
stainless steel AISI-316, silicone and epoxy seal (-60 °C till +150 °C)

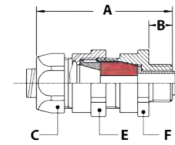

THREAD ISO	SEALTITE SIZE (INCH)	CLAMPING RANGE (MM)	DIMENSIONS IN MM					STANDARD PACKAGE	ARTICLE NUMBER	WEIGHT (KG/100)
			A	B	C	E	F			
M16 x 1,5	3/8"	6 - 8	71	15	26	25	24	10	822.110.6	10,8
M16 x 1,5	3/8"	8 - 10	71	15	26	25	24	10	822.111.6	10,8
M20 x 1,5	3/8"	8 - 10	71	15	26	25	24	10	822.109.6	10,8
M20 x 1,5	1/2"	5,5 - 8	74	15	30	32	30	10	822.112.6	17,8
M20 x 1,5	1/2"	8 - 10,5	74	15	30	32	30	10	822.113.6	17,8
M20 x 1,5	1/2"	10,5 - 13	74	15	30	32	30	10	822.114.6	17,8
M25 x 1,5	3/4"	10,5 - 13	74	15	35	36	36	5	822.115.6	21,6
M25 x 1,5	3/4"	13 - 15,5	74	15	35	36	36	5	822.118.6	21,6
M25 x 1,5	3/4"	15,5 - 18	74	15	35	36	36	5	822.119.6	21,6
M32 x 1,5	1"	15 - 18	90	15	45	45	42	5	822.123.6	38
M32 x 1,5	1"	18 - 21	90	15	45	45	42	5	822.124.6	38
M32 x 1,5	1"	21 - 23,5	90	15	45	45	42	5	822.125.6	38
M40 x 1,5	1.1/4"	21 - 24	94	15	55	55	48	2	822.129.6	45,1
M40 x 1,5	1.1/4"	24 - 27	94	15	55	55	48	2	822.130.6	45,1
M40 x 1,5	1.1/4"	27 - 30	94	15	55	55	48	2	822.131.6	45,1

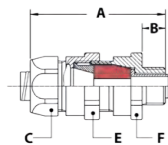

BNA-316, NPT, IECEx-ATEX barrier cable-hose fitting, stainless steel AISI-316, silicone and epoxy seal (-60 °C till +150 °C)



THREAD NPT	SEALTITE SIZE (INCH)	CLAMPING RANGE (MM)	DIMENSIONS IN MM					STANDARD PACKAGE	ARTICLE NUMBER	WEIGHT (KG/100)
			A	B	C	E	F			
NPT 1/2"	3/8"	6 - 8	74	18	26	25	24	10	824.110.6	10,8
NPT 1/2"	3/8"	8 - 10	74	18	26	25	24	10	824.111.6	10,8
NPT 1/2"	1/2"	5,5 - 8	77	18	30	32	30	10	824.112.6	17,8
NPT 1/2"	1/2"	8 - 10,5	77	18	30	32	30	10	824.113.6	17,8
NPT 1/2"	1/2"	10,5 - 13	77	18	30	32	30	10	824.114.6	17,8
NPT 3/4"	3/4"	10,5 - 13	77	18	35	36	36	5	824.115.6	21,6
NPT 3/4"	3/4"	13 - 15,5	77	18	35	36	36	5	824.118.6	21,6
NPT 3/4"	3/4"	15,5 - 18	77	18	35	36	36	5	824.119.6	21,6
NPT 1"	1"	15 - 18	97	22	45	45	42	5	824.123.6	38
NPT 1"	1"	18 - 21	97	22	45	45	42	5	824.124.6	38
NPT 1"	1"	21 - 23,5	97	22	45	45	42	5	824.125.6	38

Atex  
fittings

# Anaconda IECEx-ATEX, BAA-316, IP 66 / 68, stainless steel

For armoured cable, IECEx-ATEX certified and marked;

▲ RCN (type) (thread size) IECEx INE 10.0010X Ex d/e I Mb IIC Gb Ex tb IIIC Db

CE 0080 INERIS 06ATEX0014X I M2 / II 2 GD, IP 66 / IP 68



BAA-316, ISO, IECEx-ATEX EMC barrier cable-hose fitting, stainless steel AISI-316, EPDM and epoxy seal (-40 °C till +100 °C)

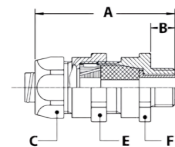

THREAD ISO	SEALTITE SIZE (INCH)	CLAMPING RANGE (MM)	DIMENSIONS IN MM					STANDARD PACKAGE	ARTICLE NUMBER	WEIGHT (KG/100)
			A	B	C	E	F			
M16 x 1,5	3/8"	4 - 7	71	15	26	25	24	10	822.310.9	10,8
M16 x 1,5	3/8"	7 - 10	71	15	26	25	24	10	822.311.9	10,8
M20 x 1,5	3/8"	4 - 7	71	15	26	25	24	10	822.308.9	10,8
M20 x 1,5	3/8"	7 - 10	71	15	26	25	24	10	822.309.9	10,8
M20 x 1,5	1/2"	5,5 - 8	74	15	30	32	30	10	822.312.9	17,8
M20 x 1,5	1/2"	8 - 10,5	74	15	30	32	30	10	822.313.9	17,8
M20 x 1,5	1/2"	10,5 - 13	74	15	30	32	30	10	822.314.9	17,8
M25 x 1,5	3/4"	10,5 - 13	74	15	35	36	36	5	822.315.9	21,6
M25 x 1,5	3/4"	13 - 15,5	74	15	35	36	36	5	822.318.9	21,6
M25 x 1,5	3/4"	15,5 - 18	74	15	35	36	36	5	822.319.9	21,6
M32 x 1,5	1"	15 - 18	90	15	45	45	42	5	822.323.9	38
M32 x 1,5	1"	18 - 21	90	15	45	45	42	5	822.324.9	38
M32 x 1,5	1"	21 - 23,5	90	15	45	45	42	5	822.325.9	38
M40 x 1,5	1.1/4"	21 - 24	94	15	55	55	48	2	822.329.9	45,1
M40 x 1,5	1.1/4"	24 - 27	94	15	55	55	48	2	822.330.9	45,1
M40 x 1,5	1.1/4"	27 - 30	94	15	55	55	48	2	822.331.9	45,1

BAA-316, NPT, IECEx-ATEX EMC barrier cable-hose fitting, stainless steel AISI-316, EPDM and epoxy seal (-40 °C till +100 °C)

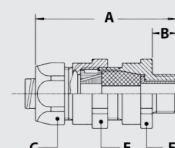

THREAD ISO	SEALTITE SIZE (INCH)	CLAMPING RANGE (MM)	DIMENSIONS IN MM					STANDARD PACKAGE	ARTICLE NUMBER	WEIGHT (KG/100)
			A	B	C	E	F			
NPT 1/2"	3/8"	4 - 7	74	18	26	25	24	10	824.310.9	10,8
NPT 1/2"	3/8"	7 - 10	74	18	26	25	24	10	824.311.9	10,8
NPT 1/2"	1/2"	5,5 - 8	77	18	30	32	30	10	824.312.9	17,8
NPT 1/2"	1/2"	8 - 10,5	77	18	30	32	30	10	824.313.9	17,8
NPT 1/2"	1/2"	10,5 - 13	77	18	30	32	30	10	824.314.9	17,8
NPT 3/4"	3/4"	10,5 - 13	77	18	35	36	36	5	824.315.9	21,6
NPT 3/4"	3/4"	13 - 15,5	77	18	35	36	36	5	824.318.9	21,6
NPT 3/4"	3/4"	15,5 - 18	77	18	35	36	36	5	824.319.9	21,6
NPT 1"	1"	15 - 18	97	22	45	45	42	5	824.323.9	38
NPT 1"	1"	18 - 21	97	22	45	45	42	5	824.324.9	38
NPT 1"	1"	21 - 23,5	97	22	45	45	42	5	824.325.9	38

## ANACONDA IECEX-ATEX, BAA-316, IP 66 / 68, STAINLESS STEEL

For armoured cable, IECEX-ATEX certified and marked;

▲ RCN (type) (thread size) IECEX INE 10.0010X Ex d/e I Mb IIC Gb Ex tb IIIC Db  
 ⚙️ CE 0080 INERIS 06ATEX0014X I M2 / II 2 GD, IP 66 / IP 68

BAA-316, ISO, IECEX-ATEX EMC barrier cable-hose fitting,  
 stainless steel AISI-316, silicone and epoxy seal (-60 °C till +150 °C)

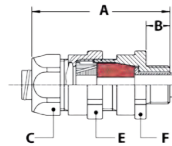

THREAD ISO	SEALTITE SIZE (INCH)	CLAMPING RANGE (MM)	DIMENSIONS IN MM					STANDARD PACKAGE	ARTICLE NUMBER	WEIGHT (KG/100)
			A	B	C	E	F			
M16 x 1,5	3/8"	6 - 8	71	15	26	25	24	10	822.310.6	10,8
M16 x 1,5	3/8"	8 - 10	71	15	26	25	24	10	822.311.6	10,8
M20 x 1,5	3/8"	8 - 10	71	15	26	25	24	10	822.309.6	10,8
M20 x 1,5	1/2"	5,5 - 8	74	15	30	32	30	10	822.312.6	17,8
M20 x 1,5	1/2"	8 - 10,5	74	15	30	32	30	10	822.313.6	17,8
M20 x 1,5	1/2"	10,5 - 13	74	15	30	32	30	10	822.314.6	17,8
M25 x 1,5	3/4"	10,5 - 13	74	15	35	36	36	5	822.315.6	21,6
M25 x 1,5	3/4"	13 - 15,5	74	15	35	36	36	5	822.318.6	21,6
M25 x 1,5	3/4"	15,5 - 18	74	15	35	36	36	5	822.319.6	21,6
M32 x 1,5	1"	15 - 18	90	15	45	45	42	5	822.323.6	38
M32 x 1,5	1"	18 - 21	90	15	45	45	42	5	822.324.6	38
M32 x 1,5	1"	21 - 23,5	90	15	45	45	42	5	822.325.6	38
M40 x 1,5	1.1/4"	21 - 24	94	15	55	55	48	2	822.329.6	45,1
M40 x 1,5	1.1/4"	24 - 27	94	15	55	55	48	2	822.330.6	45,1
M40 x 1,5	1.1/4"	27 - 30	94	15	55	55	48	2	822.331.6	45,1

BAA-316, NPT, IECEX-ATEX EMC barrier cable-hose fitting,  
 stainless steel AISI-316, silicone and epoxy seal (-60 °C till +150 °C)

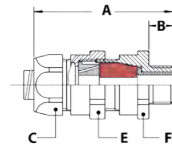

THREAD NPT	SEALTITE SIZE (INCH)	CLAMPING RANGE (MM)	DIMENSIONS IN MM					STANDARD PACKAGE	ARTICLE NUMBER	WEIGHT (KG/100)
			A	B	C	E	F			
NPT 1/2"	3/8"	6 - 8	74	18	26	25	24	10	824.310.6	10,8
NPT 1/2"	3/8"	8 - 10	74	18	26	25	24	10	824.311.6	10,8
NPT 1/2"	1/2"	5,5 - 8	77	18	30	32	30	10	824.312.6	17,8
NPT 1/2"	1/2"	8 - 10,5	77	18	30	32	30	10	824.313.6	17,8
NPT 1/2"	1/2"	10,5 - 13	77	18	30	32	30	10	824.314.6	17,8
NPT 3/4"	3/4"	10,5 - 13	77	18	35	36	36	5	824.315.6	21,6
NPT 3/4"	3/4"	13 - 15,5	77	18	35	36	36	5	824.318.6	21,6
NPT 3/4"	3/4"	15,5 - 18	77	18	35	36	36	5	824.319.6	21,6
NPT 1"	1"	15 - 18	97	22	45	45	42	5	824.323.6	38
NPT 1"	1"	18 - 21	97	22	45	45	42	5	824.324.6	38
NPT 1"	1"	21 - 23,5	97	22	45	45	42	5	824.325.6	38

Atex fittings

### Special information for EMC cable-hose fittings

- In case of EMC versions, the cable diameter needed to determine the clamping range, is not the outer diameter of the cable but the diameter of the cable without the braiding.
- In case of EMC versions with a wire diameter (S) from 1,0 till 2,5 mm (type SWA, Steel Wire Armour) a special version with reduced cone rings must be ordered (article no. with suffix "-RC").

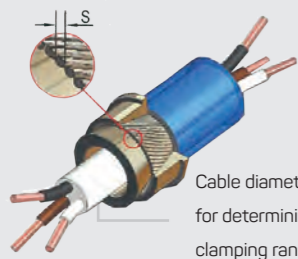

Cable diameter for determining clamping range

# Adapter IECEx-ATEX, BXC, IP 66 / 68, nickel plated brass



## ANACONDA IECEx-ATEX SWIVEL BARRIER ADAPTER FITTING TYPE BXC, NICKEL PLATED BRASS

The type BXC IECEx-ATEX approved nickel plated barrier swivel adapter fitting, male one side, female other side, is developed for use with an Anaconda liquid tight flexible conduit for loose wires and unarmoured cables (stripped) when a 45° or 90° solution is needed. Connection with an Anaconda conduit is made through a standard male Anaconda fitting (45° or 90°) which is screwed into the female thread of the adapter. The barrier is made by mixing a 2 component epoxy resin supplied standard with each adapter. The BXC type can also be used to make a connection with a rigid metal conduit or other threaded connections. Typical applications include motors, transformers, control equipment, Ex enclosures, terminal boxes and components etc., in the chemical and petrochemical, oil and gas, wood processing, bulk handling and food and pharma industries.

### Material & Construction:

**Construction:** Nickel plated brass fitting, consisting of 4 parts (female body, swivel nut, barrier container and male body).

Separately, a 2 component epoxy resin is supplied for creating the barrier.

**Material:** Female body, swivel nut, barrier container and male body are nickel plated brass.

Also available in stainless steel AISI-316.

Fittings are fully RoHS compliant.

**Temperature:** -60 °C till +130 °C continuous.

**Protection class:** IP 66 between body and switchbox.

IP 68 can be obtained with a flat seal between body and switchbox.

**Colour:** Metal coloured.

For loose wires and unarmoured cables (stripped), IECEx-ATEX certified and marked;  
 ⚠ RCN (type) (thread size) IECEx CES 15.0001X Ex db / eb I Mb IIC Gb Ex tb IIIC Db  
 ⚠ CE 0080 CESI 14ATEX069X I M2 / II 2 GD, IP 66 / IP 68

BXC, ISO, Explosion proof IECEx-ATEX swivel adapter fitting, nickel plated brass, epoxy barrier type (-60 °C till +130 °C)

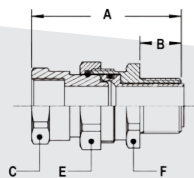

THREAD OUTSIDE	THREAD INSIDE	MIN. INTERNAL BORE (MM)	DIMENSIONS IN MM					STANDARD PACKAGE	ARTICLE NUMBER	WEIGHT (KG/100)
			A	B	C	E	F			
M16 x 1,5	M16 x 1,5	10,4	63	15	22	26	25	10	836.116.0*	13
M20 x 1,5	M20 x 1,5	13,8	64	15	26	30	28	10	836.120.0	16,3
M25 x 1,5	M25 x 1,5	18,5	67	15	32	35	34	5	836.125.0	22,9
M32 x 1,5	M32 x 1,5	24,4	69	15	38	45	43	5	836.132.0	35,1
M40 x 1,5	M40 x 1,5	31,9	71	15	48	55	52	2	836.140.0	50,7
M50 x 1,5	M50 x 1,5	37,9	74	15	55	57	55	2	836.150.0	58,8

\* Size M16 - M16 is not permitted for Group I (Mining) applications.

Anaconda 45° and 90° fittings, nickel plated brass, for combination with adapter type BXC see chapter 5 of the general catalogue.

## ADAPTER IECEX-ATEX, BXC, IP 66 / 68, NICKEL PLATED BRASS

For loose wires and unarmoured cables (stripped), IECEX-ATEX certified and marked;  
 ▲ RCN (type) (thread size) IECEX CES 15.0001X Ex db / eb I Mb IIC Gb Ex tb IIIC Db  
 ⚡ CE 0080 CESI 14ATEX069X I M2 / II 2 GD, IP 66 / IP 68

BXC, NPT, Explosion proof IECEX-ATEX swivel adapter fitting,  
 nickel plated brass, epoxy barrier type (-60 °C till +130 °C)

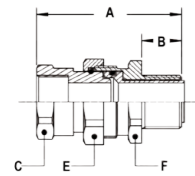

THREAD OUTSIDE	THREAD INSIDE	MIN. INTERNAL BORE (MM)	DIMENSIONS IN MM					STANDARD PACKAGE	ARTICLE NUMBER	WEIGHT (KG/100)
			A	B	C	E	F			
NPT 1/2"	NPT 1/2"	13,8	76	20	26	30	28	10	837.116.0	17,6
NPT 3/4"	NPT 3/4"	18,5	78	21	32	35	34	5	837.120.0	23,9
NPT 1"	NPT 1"	24,4	89	25	38	45	43	5	837.126.0	40,7
NPT 1.1/4"	NPT 1.1/4"	31,9	93	26	48	55	52	2	837.135.0	57,8
NPT 1.1/2"	NPT 1.1/2"	37,9	93	26	55	57	55	2	837.140.0	68,4

BXC, Pg, Explosion proof IECEX-ATEX swivel adapter fitting,  
 nickel plated brass, epoxy barrier type (-60 °C till +130 °C)

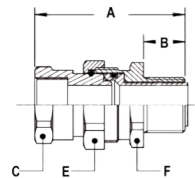

THREAD OUTSIDE	THREAD INSIDE	MIN. INTERNAL BORE (MM)	DIMENSIONS IN MM					STANDARD PACKAGE	ARTICLE NUMBER	WEIGHT (KG/100)
			A	B	C	E	F			
Pg 13,5	M16 x 1,5	10,4	63	15	22	26	25	10	837.513.0	13,2
Pg 16	M20 x 1,5	13,8	64	15	26	30	28	10	837.516.0	14,6
Pg 21	M25 x 1,5	18,5	67	15	32	35	34	5	837.521.0	20,5
Pg 29	M32 x 1,5	24,4	69	15	38	45	43	5	837.529.0	29,5
Pg 36	M40 x 1,5	31,9	71	15	48	55	52	2	837.536.0	41,5

Anaconda 45° and 90° fittings, nickel plated brass, for combination with adapter type BXC see chapter 5 of the general catalogue.

Atex fittings



# Adapter IECEx-ATEX, BXC-316, IP 66 / 68, stainless steel



## ANACONDA IECEx-ATEX SWIVEL BARRIER ADAPTER FITTING TYPE BXC-316, STAINLESS STEEL AISI-316

Type BXC-316 IECEx-ATEX approved stainless steel barrier swivel adapter fittings, male one side, female other side, are designed for use with an Anaconda liquid tight flexible conduit for the protection of loose wires and unarmoured cables (stripped) when a 45° or 90° solution is needed. The use of stainless steel materials provides corrosion and chemical resistance in harsh environments. Connection with an Anaconda conduit is made with a standard male Anaconda fitting (45° or 90°) which is screwed into the female thread of the adapter. The barrier is made by mixing a 2 component epoxy resin supplied with each adapter. The BXC-316 type can also be used to make a connection with a rigid metal conduit or other threaded connections. Typical applications include motors, transformers, control equipment, Ex enclosures, terminal boxes and components etc., in the chemical and petrochemical, oil and gas, wood processing, bulk handling and food and pharma industries.

### Material & Construction:

**Construction:** Stainless steel AISI-316 fitting, consisting of 4 parts (female body, swivel nut, barrier container and male body).

Separately, a 2 component epoxy resin is supplied for creating the barrier.

**Material:** Female body, swivel nut and male body are stainless steel AISI-316. The barrier container is nickel plated brass.

Fittings are fully RoHS compliant.

**Temperature:** -60 °C till +130 °C continuous.

**Protection class:** IP 66 between body and switchbox. IP 68 can be obtained with a flat seal between body and switchbox.

**Colour:** Metal coloured.

For loose wires and unarmoured cables (stripped), IECEx-ATEX certified and marked;  
 ⚠ RCN (type) (thread size) IECEx CES 15.0001X Ex db / eb I Mb IIC Gb Ex tb IIIC Db  
 ⚠ CE 0080 CESI 14ATEX069X I M2 / II 2 GD, IP 66 / IP 68

BXC-316, ISO, Explosion proof IECEx-ATEX swivel adapter fitting, stainless steel AISI-316, epoxy barrier type (-60 °C till +130 °C)

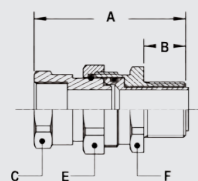

THREAD OUTSIDE	THREAD INSIDE	MIN. INTERNAL BORE (MM)	DIMENSIONS IN MM					STANDARD PACKAGE	ARTICLE NUMBER	WEIGHT (KG/100)
			A	B	C	E	F			
M16 x 1,5	M16 x 1,5	10,4	63	15	22	26	25	10	836.116.9*	12,2
M20 x 1,5	M20 x 1,5	13,8	64	15	26	30	28	10	836.120.9	15,4
M25 x 1,5	M25 x 1,5	18,5	67	15	32	35	34	5	836.125.9	21,6
M32 x 1,5	M32 x 1,5	24,4	69	15	38	45	43	5	836.132.9	33,1
M40 x 1,5	M40 x 1,5	31,9	71	15	48	55	52	2	836.140.9	47,4
M50 x 1,5	M50 x 1,5	37,9	74	15	55	57	55	2	836.150.9	55,5

\* Size M16 - M16 is not permitted for Group I (Mining) applications.

Anaconda 45° and 90° fittings, stainless steel, for combination with adapter type BXC-316 see chapter 5 of the general catalogue.

## ADAPTER IECEX-ATEX, BXC-316, IP 66 / 68, STAINLESS STEEL

For loose wires and unarmoured cables (stripped), IECEx-ATEX certified and marked;  
 ▲ RCN (type) (thread size) IECEx CES 15.0001X Ex db / eb I Mb IIC Gb Ex tb IIIC Db  
 ⚡ CE 0080 CESI 14ATEX069X I M2 / II 2 GD, IP 66 / IP 68

BXC-316, NPT, Explosion proof IECEx-ATEX swivel adapter fitting,  
 stainless steel AISI-316, epoxy barrier type (-60 °C till +130 °C)

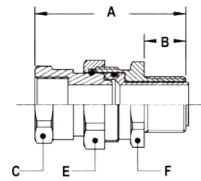

THREAD OUTSIDE	THREAD INSIDE	MIN. INTERNAL BORE (MM)	DIMENSIONS IN MM					STANDARD PACKAGE	ARTICLE NUMBER	WEIGHT (KG/100)
			A	B	C	E	F			
NPT 1/2"	NPT 1/2"	13,8	76	20	26	30	28	10	837.116.9	16,7
NPT 3/4"	NPT 3/4"	18,5	78	21	32	35	34	5	837.120.9	22,6
NPT 1"	NPT 1"	24,4	89	25	38	45	43	5	837.126.9	38,5
NPT 1.1/4"	NPT 1.1/4"	31,9	93	26	48	55	52	2	837.135.9	54,6
NPT 1.1/2"	NPT 1.1/2"	37,9	93	26	55	57	55	2	837.140.9	64,6

BXC-316, Pg, Explosion proof IECEx-ATEX swivel adapter fitting,  
 stainless steel AISI-316, epoxy barrier type (-60 °C till +130 °C)

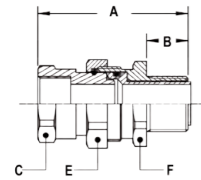

THREAD OUTSIDE	THREAD INSIDE	MIN. INTERNAL BORE (MM)	DIMENSIONS IN MM					STANDARD PACKAGE	ARTICLE NUMBER	WEIGHT (KG/100)
			A	B	C	E	F			
Pg 13,5	M16 x 1,5	10,4	63	15	22	26	25	10	837.513.9	12,4
Pg 16	M20 x 1,5	13,8	64	15	26	30	28	10	837.516.9	13,6
Pg 21	M25 x 1,5	18,5	67	15	32	35	34	5	837.521.9	19,4
Pg 29	M32 x 1,5	24,4	69	15	38	45	43	5	837.529.9	27,9
Pg 36	M40 x 1,5	31,9	71	15	48	55	52	2	837.536.9	39,3

Anaconda 45° and 90° fittings, stainless steel, for combination with adapter type BXC-316 see chapter 5 of the general catalogue.

Atex fittings

# Adapter IECEx-ATEX, RNC, IP 66 / 68, nickel plated brass



## ANAMET IECEx-ATEX ADAPTER FITTING, TYPE RNC AND RAC, NICKEL PLATED BRASS

Type RNC IECEx-ATEX approved nickel plated brass adapter fitting, male one side, female other side, was originally developed to connect to threaded rigid conduit but can also be used with a flexible metal conduit to protect unarmoured cable in a potentially explosive atmosphere when a 45° or a 90° solution is needed. The connection with an Anaconda flexible conduit is made with a standard male 45° or 90° Anaconda, nickel plated brass, swivel fitting which is screwed into the female thread of the adapter. Since RNA cable-hose fittings are available upto 1.1/4", the RNC 1.1/2" to 3" adapter in combination with Anaconda standard fittings can be used when larger sizes are required. Typical applications include motors, transformers, control equipment, Ex enclosures, terminal boxes and components etc., in the chemical and petrochemical, oil and gas, wood processing, bulk handling and food and pharma industries. Also available in a version for armoured cable (type RAC, pages 7 - 40 till 7 - 41). On demand the version with silicone seal for high temperatures is also available.

### Material & Construction:

**Construction:** Nickel plated brass fitting, consisting of 4 parts (female body, pressure ring, sealing rubber and male body).

**Material:** Female body, pressure ring and male body are nickel plated brass and sealing rubber is from EPDM. Also available in stainless steel AISI-316.

**Temperature:** -40 °C till +100 °C continuous. With silicone pressure rubber -65 °C till +220 °C continuous.

**Protection class:** Standard is IP 66, with a flat seal between body and switchbox IP 68.

**Colour:** Metal coloured.

For loose wires and unarmoured cables (stripped), IECEx-ATEX certified and marked;  
 ▲ RCN (type) (thread size) IECEx CES 15.0001X Ex db / eb I Mb IIC Gb Ex tb IIIC Db  
 ⚡ CE 0080 CESI 14ATEX069X I M2 / II 2 GD, IP 66 / IP 68

RNC, ISO, IECEx-ATEX adapter fitting, nickel plated brass, EPDM seal (-40 °C till +100 °C)

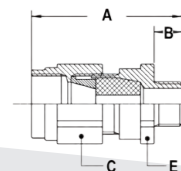

THREAD OUTER ISO	THREAD INNER NPT	CLAMPING RANGE (MM)	DIMENSIONS IN MM					STANDARD PACKAGE	ARTICLE NUMBER	WEIGHT (KG/100)
			A	B	C	D	E			
M20 x 1,5	NPT 1/2"	5,5 - 8	63	15	32	-	30	10	297.812.0	17,4
M20 x 1,5	NPT 1/2"	8 - 10,5	63	15	32	-	30	10	297.813.0	17,4
M20 x 1,5	NPT 1/2"	10,5 - 13	63	15	32	-	30	10	297.814.0	17,4
M25 x 1,5	NPT 3/4"	10,5 - 13	63	15	36	-	35	5	297.815.0	20,6
M25 x 1,5	NPT 3/4"	13 - 15,5	63	15	36	-	35	5	297.818.0	20,6
M25 x 1,5	NPT 3/4"	15,5 - 18	63	15	36	-	35	5	297.819.0	20,6
M32 x 1,5	NPT 1"	15 - 18	76	15	45	-	42	5	297.823.0	35,6
M32 x 1,5	NPT 1"	18 - 21	76	15	45	-	42	5	297.824.0	35,6
M32 x 1,5	NPT 1"	21 - 24	76	15	45	-	42	5	297.825.0	35,6
M40 x 1,5	NPT 1.1/4"	21 - 24	79	15	50	-	48	2	297.829.0	43,1
M40 x 1,5	NPT 1.1/4"	24 - 27	79	15	50	-	48	2	297.830.0	43,1
M40 x 1,5	NPT 1.1/4"	27 - 30	79	15	50	-	48	2	297.831.0	43,1
M50 x 1,5	NPT 1.1/2"	30 - 33	79	15	57	-	55	2	297.843.0	56,8
M50 x 1,5	NPT 1.1/2"	33 - 36	79	15	57	-	55	2	297.844.0	56,8
M63 x 1,5	NPT 2"	36 - 39	80	15	68	-	68	2	297.851.0	78,4
M63 x 1,5	NPT 2"	39 - 42	80	15	68	-	68	2	297.852.0	78,4
M63 x 1,5	NPT 2"	42 - 45	80	15	68	-	68	2	297.853.0	78,4
M75 x 1,5	NPT 2.1/2"	45 - 48	91	15	80	-	80	1	297.854.0	112,4
M75 x 1,5	NPT 2.1/2"	48 - 51	91	15	80	-	80	1	297.855.0	112,4
M75 x 1,5	NPT 2.1/2"	51 - 54	91	15	80	-	80	1	297.856.0	112,4
M90 x 2	NPT 3"	54 - 58	103	20	102	-	100	1	297.857.0	223,5
M90 x 2	NPT 3"	58 - 62	103	20	102	-	100	1	297.858.0	223,5

## ADAPTER IECEX-ATEX, RNC, IP 66 / 68, NICKEL PLATED BRASS

For unarmoured cable, IECEX-ATEX certified and marked;

▲ RCN (type) (thread size) IECEX INE 10.0010X Ex d/e I Mb IIC Gb Ex tb IIIC Db

CE 0080 INERIS 06ATEX0014X I M2 / II 2 GD, IP 66 / IP 68

RNC, NPT, IECEX-ATEX adapter fitting, nickel plated brass,  
EPDM seal (-40 °C till +100 °C)

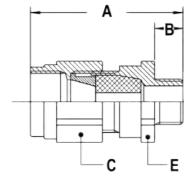

THREAD OUTER NPT	THREAD INNER NPT	CLAMPING RANGE (MM)	DIMENSIONS IN MM					STANDARD PACKAGE	ARTICLE NUMBER	WEIGHT (KG/100)
			A	B	C	D	E			
NPT 1/2"	NPT 1/2"	5,5 - 8	66	18	32	-	30	10	297.912.0	17,4
NPT 1/2"	NPT 1/2"	8 - 10,5	66	18	32	-	30	10	297.913.0	17,4
NPT 1/2"	NPT 1/2"	10,5 - 13	66	18	32	-	30	10	297.914.0	17,4
NPT 3/4"	NPT 3/4"	10,5 - 13	66	18	36	-	35	5	297.915.0	20,6
NPT 3/4"	NPT 3/4"	13 - 15,5	66	18	36	-	35	5	297.918.0	20,6
NPT 3/4"	NPT 3/4"	15,5 - 18	66	18	36	-	35	5	297.919.0	20,6
NPT 1"	NPT 1"	15 - 18	83	22	45	-	42	5	297.923.0	35,6
NPT 1"	NPT 1"	18 - 21	83	22	45	-	42	5	297.924.0	35,6
NPT 1"	NPT 1"	21 - 24	83	22	45	-	42	5	297.925.0	35,6
NPT 1.1/4"	NPT 1.1/4"	21 - 24	86	22	50	-	48	2	297.929.0	43,1
NPT 1.1/4"	NPT 1.1/4"	24 - 27	86	22	50	-	48	2	297.930.0	43,1
NPT 1.1/4"	NPT 1.1/4"	27 - 30	86	22	50	-	48	2	297.931.0	43,1
NPT 1.1/2"	NPT 1.1/2"	30 - 33	88	24	57	-	55	2	297.943.0	56,8
NPT 1.1/2"	NPT 1.1/2"	33 - 36	88	24	57	-	55	2	297.944.0	56,8
NPT 2"	NPT 2"	36 - 39	89	24	68	-	68	2	297.951.0	78,4
NPT 2"	NPT 2"	39 - 42	89	24	68	-	68	2	297.952.0	78,4
NPT 2"	NPT 2"	42 - 45	89	24	68	-	68	2	297.953.0	78,4
NPT 2.1/2"	NPT 2.1/2"	45 - 48	104	28	80	-	80	1	297.954.0	112,4
NPT 2.1/2"	NPT 2.1/2"	48 - 51	104	28	80	-	80	1	297.955.0	112,4
NPT 2.1/2"	NPT 2.1/2"	51 - 54	104	28	80	-	80	1	297.956.0	112,4
NPT 3"	NPT 3"	54 - 58	111	28	102	-	100	1	297.957.0	223,5
NPT 3"	NPT 3"	58 - 62	111	28	102	-	100	1	297.958.0	223,5

Atex fittings

RNC, Pg, IECEX-ATEX adapter fitting, nickel plated brass,  
EPDM seal (-40 °C till +100 °C)

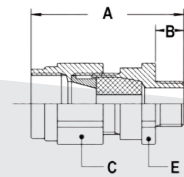

THREAD OUTER PG	THREAD INNER NPT	CLAMPING RANGE (MM)	DIMENSIONS IN MM					STANDARD PACKAGE	ARTICLE NUMBER	WEIGHT (KG/100)
			A	B	C	D	E			
Pg 11	NPT 1/2"	5,5 - 8	63	15	32	-	30	10	297.611.0	17,4
Pg 13,5	NPT 1/2"	5,5 - 8	63	15	32	-	30	10	297.612.0	17,4
Pg 13,5	NPT 1/2"	8 - 10,5	63	15	32	-	30	10	297.613.0	17,4
Pg 13,5	NPT 1/2"	10,5 - 13	63	15	32	-	30	10	297.614.0	17,4
Pg 16	NPT 3/4"	10,5 - 13	63	15	36	-	35	5	297.615.0	20,6
Pg 16	NPT 3/4"	13 - 15,5	63	15	36	-	35	5	297.618.0	20,6
Pg 16	NPT 3/4"	15,5 - 18	63	15	36	-	35	5	297.619.0	20,6
Pg 21	NPT 1"	15 - 18	76	15	45	-	42	5	297.623.0	35,6
Pg 21	NPT 1"	18 - 21	76	15	45	-	42	5	297.624.0	35,6
Pg 21	NPT 1"	21 - 24	76	15	45	-	42	5	297.625.0	35,6
Pg 29	NPT 1.1/4"	21 - 24	81	17	50	-	48	2	297.629.0	43,1
Pg 29	NPT 1.1/4"	24 - 27	81	17	50	-	48	2	297.630.0	43,1
Pg 29	NPT 1.1/4"	27 - 30	81	17	50	-	48	2	297.631.0	43,1
Pg 36	NPT 1.1/2"	30 - 33	81	17	57	-	55	2	297.643.0	56,8
Pg 36	NPT 1.1/2"	33 - 36	81	17	57	-	55	2	297.644.0	56,8
Pg 48	NPT 2"	36 - 39	83	18	68	-	68	2	297.651.0	78,4
Pg 48	NPT 2"	39 - 42	83	18	68	-	68	2	297.652.0	78,4
Pg 48	NPT 2"	42 - 45	83	18	68	-	68	2	297.653.0	78,4

# Adapter IECEx-ATEX, RAC, IP 66 / 68, nickel plated brass

For armoured cable, IECEx-ATEX certified and marked;

▲ RCN (type) (thread size) IECEx INE 10.0010X Ex d/e I Mb IIC Gb Ex tb IIIC Db

CE 0080 INERIS 06ATEX0014X I M2 / II 2 GD, IP 66 / IP 68



RAC, ISO, IECEx-ATEX EMC adapter fitting, nickel plated brass,  
EPDM seal (-40 °C till +100 °C)

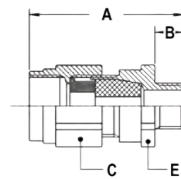

THREAD OUTER ISO	THREAD INNER NPT	CLAMPING RANGE (MM)	DIMENSIONS IN MM					STANDARD PACKAGE	ARTICLE NUMBER	WEIGHT (KG/100)
			A	B	C	D	E			
M20 x 1,5	NPT 1/2"	5,5 - 8	63	15	32	-	30	10	839.812.0	17,4
M20 x 1,5	NPT 1/2"	8 - 10,5	63	15	32	-	30	10	839.813.0	17,4
M20 x 1,5	NPT 1/2"	10,5 - 13	63	15	32	-	30	10	839.814.0	17,4
M25 x 1,5	NPT 3/4"	10,5 - 13	63	15	36	-	35	5	839.815.0	20,6
M25 x 1,5	NPT 3/4"	13 - 15,5	63	15	36	-	35	5	839.818.0	20,6
M25 x 1,5	NPT 3/4"	15,5 - 18	63	15	36	-	35	5	839.819.0	20,6
M32 x 1,5	NPT 1"	15 - 18	76	15	45	-	42	5	839.823.0	35,6
M32 x 1,5	NPT 1"	18 - 21	76	15	45	-	42	5	839.824.0	35,6
M32 x 1,5	NPT 1"	21 - 24	76	15	45	-	42	5	839.825.0	35,6
M40 x 1,5	NPT 1.1/4"	21 - 24	79	15	50	-	48	2	839.829.0	43,1
M40 x 1,5	NPT 1.1/4"	24 - 27	79	15	50	-	48	2	839.830.0	43,1
M40 x 1,5	NPT 1.1/4"	27 - 30	79	15	50	-	48	2	839.831.0	43,1
M50 x 1,5	NPT 1.1/2"	30 - 33	79	15	57	-	55	2	839.843.0	56,8
M50 x 1,5	NPT 1.1/2"	33 - 36	79	15	57	-	55	2	839.844.0	56,8
M63 x 1,5	NPT 2"	36 - 39	80	15	68	-	68	2	839.851.0	78,4
M63 x 1,5	NPT 2"	39 - 42	80	15	68	-	68	2	839.852.0	78,4
M63 x 1,5	NPT 2"	42 - 45	80	15	68	-	68	2	839.853.0	78,4
M75 x 1,5	NPT 2.1/2"	45 - 48	91	15	80	-	80	1	839.854.0	112,4
M75 x 1,5	NPT 2.1/2"	48 - 51	91	15	80	-	80	1	839.855.0	112,4
M75 x 1,5	NPT 2.1/2"	51 - 54	91	15	80	-	80	1	839.856.0	112,4
M90 x 2	NPT 3"	54 - 58	103	20	102	-	100	1	839.857.0	223,5
M90 x 2	NPT 3"	58 - 62	103	20	102	-	100	1	839.858.0	223,5

## Special information for EMC cable-hose fittings

1. In case of EMC versions, the cable diameter needed to determine the clamping range, is not the outer diameter of the cable but the diameter of the cable without the braiding.
2. In case of EMC versions with a wire diameter (S) from 1,0 till 2,5 mm (type SWA, Steel Wire Armour) a special version with reduced cone clamping rings must be ordered (article no. with suffix "-RC").

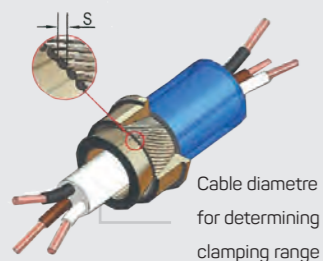

## ADAPTER IECEX-ATEX, RAC, IP 66 / 68, NICKEL PLATED BRASS

For armoured cable, IECEX-ATEX certified and marked;

▲ RCN (type) (thread size) IECEX INE 10.0010X Ex d/e I Mb IIC Gb Ex tb IIIC Db

CE 0080 INERIS 06ATEX0014X I M2 / II 2 GD, IP 66 / IP 68

RAC, NPT, IECEX-ATEX, EMC adapter fitting, nickel plated brass,  
EPDM seal (-40 °C till +100 °C)

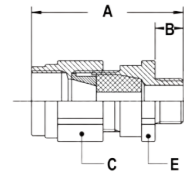

THREAD OUTER NPT	THREAD INNER NPT	CLAMPING RANGE (MM)	DIMENSIONS IN MM					STANDARD PACKAGE	ARTICLE NUMBER	WEIGHT (KG/100)
			A	B	C	D	E			
NPT 1/2"	NPT 1/2"	5,5 - 8	66	18	32	-	30	10	839.912.0	17,4
NPT 1/2"	NPT 1/2"	8 - 10,5	66	18	32	-	30	10	839.913.0	17,4
NPT 1/2"	NPT 1/2"	10,5 - 13	66	18	32	-	30	10	839.914.0	17,4
NPT 3/4"	NPT 3/4"	10,5 - 13	66	18	36	-	35	5	839.915.0	20,6
NPT 3/4"	NPT 3/4"	13 - 15,5	66	18	36	-	35	5	839.918.0	20,6
NPT 3/4"	NPT 3/4"	15,5 - 18	66	18	36	-	35	5	839.919.0	20,6
NPT 1"	NPT 1"	15 - 18	83	22	45	-	42	5	839.923.0	35,6
NPT 1"	NPT 1"	18 - 21	83	22	45	-	42	5	839.924.0	35,6
NPT 1"	NPT 1"	21 - 24	83	22	45	-	42	5	839.925.0	35,6
NPT 1.1/4"	NPT 1.1/4"	21 - 24	86	22	50	-	48	2	839.929.0	43,1
NPT 1.1/4"	NPT 1.1/4"	24 - 27	86	22	50	-	48	2	839.930.0	43,1
NPT 1.1/4"	NPT 1.1/4"	27 - 30	86	22	50	-	48	2	839.931.0	43,1
NPT 1.1/2"	NPT 1.1/2"	30 - 33	88	24	57	-	55	2	839.943.0	56,8
NPT 1.1/2"	NPT 1.1/2"	33 - 36	88	24	57	-	55	2	839.944.0	56,8
NPT 2"	NPT 2"	36 - 39	89	24	68	-	68	2	839.951.0	78,4
NPT 2"	NPT 2"	39 - 42	89	24	68	-	68	2	839.952.0	78,4
NPT 2"	NPT 2"	42 - 45	89	24	68	-	68	2	839.953.0	78,4
NPT 2.1/2"	NPT 2.1/2"	45 - 48	104	28	80	-	80	1	839.954.0	112,4
NPT 2.1/2"	NPT 2.1/2"	48 - 51	104	28	80	-	80	1	839.955.0	112,4
NPT 2.1/2"	NPT 2.1/2"	51 - 54	104	28	80	-	80	1	839.956.0	112,4
NPT 3"	NPT 3"	54 - 58	111	28	102	-	100	1	839.957.0	223,5
NPT 3"	NPT 3"	58 - 62	111	28	102	-	100	1	839.958.0	223,5

Atex fittings

RAC, Pg, IECEX-ATEX, EMC adapter fitting, nickel plated brass,  
EPDM seal (-40 °C till +100 °C)

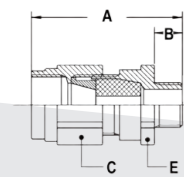

THREAD OUTER PG	THREAD INNER NPT	CLAMPING RANGE (MM)	DIMENSIONS IN MM					STANDARD PACKAGE	ARTICLE NUMBER	WEIGHT (KG/100)
			A	B	C	D	E			
Pg 11	NPT 1/2"	5,5 - 8	63	15	32	-	30	10	839.611.0	17,4
Pg 13,5	NPT 1/2"	5,5 - 8	63	15	32	-	30	10	839.612.0	17,4
Pg 13,5	NPT 1/2"	8 - 10,5	63	15	32	-	30	10	839.613.0	17,4
Pg 13,5	NPT 1/2"	10,5 - 13	63	15	32	-	30	10	839.614.0	17,4
Pg 16	NPT 3/4"	10,5 - 13	63	15	36	-	35	5	839.615.0	20,6
Pg 16	NPT 3/4"	13 - 15,5	63	15	36	-	35	5	839.618.0	20,6
Pg 16	NPT 3/4"	15,5 - 18	63	15	36	-	35	5	839.619.0	20,6
Pg 21	NPT 1"	15 - 18	76	15	45	-	42	5	839.623.0	35,6
Pg 21	NPT 1"	18 - 21	76	15	45	-	42	5	839.624.0	35,6
Pg 21	NPT 1"	21 - 24	76	15	45	-	42	5	839.625.0	35,6
Pg 29	NPT 1.1/4"	21 - 24	81	17	50	-	48	2	839.629.0	43,1
Pg 29	NPT 1.1/4"	24 - 27	81	17	50	-	48	2	839.630.0	43,1
Pg 29	NPT 1.1/4"	27 - 30	81	17	50	-	48	2	839.631.0	43,1
Pg 36	NPT 1.1/2"	30 - 33	81	17	57	-	55	2	839.643.0	56,8
Pg 36	NPT 1.1/2"	33 - 36	81	17	57	-	55	2	839.644.0	56,8
Pg 48	NPT 2"	36 - 39	83	18	68	-	68	2	839.651.0	78,4
Pg 48	NPT 2"	39 - 42	83	18	68	-	68	2	839.652.0	78,4
Pg 48	NPT 2"	42 - 45	83	18	68	-	68	2	839.653.0	78,4



# Adapter IECEx-ATEX, RNC, IP 66 / 68, nickel plated brass



## ANACONDA FITTINGS, NICKEL PLATED BRASS, FOR COMBINATION WITH ADAPTER TYPE RNC / RAC

The connection with an Anaconda conduit is made by screwing a standard male Anaconda 45° or 90° swivel fitting illustrated hereunder, or 45° or 90° fixed fitting (illustrated on chapter 5) into the female thread of the adapter. Because RNA/RAA cable-hose fittings are available only till 1.1/4", if a straight solution for larger sizes is needed, it is also possible to use the RNC / RAC adapter from 1.1/2" up to 3" size in combination with Anaconda standard straight fittings.

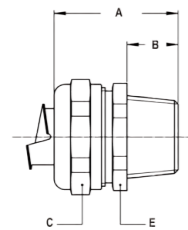

NPT straight fitting, compact, male, nickel plated brass



THREAD NPT	SEALTITE SIZE (INCH)	MIN. INTERNAL BORE (MM)	DIMENSIONS IN MM					STANDARD PACKAGE	ARTICLE NUMBER	WEIGHT (KG/100)
			A	B	C	D	E			
NPT 1/2"	3/8"	11	35	14	26	-	24	10	714.012.1	4,4
NPT 1/2"	1/2"	14,5	36	14	29	-	27	10	714.016.1	5
NPT 3/4"	3/4"	19,4	37	14	35	-	33	5	714.020.1	7
NPT 1"	1"	24,7	40	16	45	-	42	5	714.026.1	12,6
NPT 1.1/4"	1.1/4"	33,3	43	16	53	-	50	2	714.035.1	16,8
NPT 1.1/2"	1.1/2"	38	50	18	62	-	58	2	714.040.1	25,8
NPT 2"	2"	49	56	20	76	-	72	2	714.050.1	41,2
NPT 2.1/2"	2.1/2"	60,7	67	25	90	-	85	1	714.063.1*	83,6
NPT 3"	3"	75,5	73	27	108	-	102	1	714.075.1*	113,9

\* Size NPT 2.1/2" and NPT 3" are without UL / CSA.

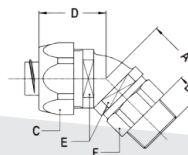

NPT 45° swivel fitting, male, nickel plated brass



THREAD NPT	SEALTITE SIZE (INCH)	MIN. INTERNAL BORE (MM)	DIMENSIONS IN MM						STANDARD PACKAGE	ARTICLE NUMBER	WEIGHT (KG/100)
			A	B	C	D	E	F			
NPT 1/2"	3/8"	10,4	36	12	26	28	22	22	10	819.412.0	11,5
NPT 1/2"	1/2"	13,8	36	12	29	30	27	25	10	819.416.0	14
NPT 3/4"	3/4"	17,4	39	12	35	32	33	31	5	819.420.0	22
NPT 1"	1"	23,4	42	13	45	37	42	38	5	819.426.0	37

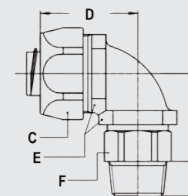

NPT 90° swivel fitting, male, nickel plated brass



THREAD NPT	SEALTITE SIZE (INCH)	MIN. INTERNAL BORE (MM)	DIMENSIONS IN MM						STANDARD PACKAGE	ARTICLE NUMBER	WEIGHT (KG/100)
			A	B	C	D	E	F			
NPT 1/2"	3/8"	10,4	41	12	26	35	22	22	10	819.912.0	12
NPT 1/2"	1/2"	13,8	41	12	29	37	27	25	10	819.916.0	14
NPT 3/4"	3/4"	17,4	48	12	35	44	33	31	5	819.920.0	23,5
NPT 1"	1"	23,4	56	13	45	55	42	38	5	819.926.0	42

# Adapter IECEx-ATEX, RNC-316, IP 66 / 68, stainless steel



## ANAMET IECEx-ATEX ADAPTER FITTING, TYPE RNC-316 AND RAC-316, STAINLESS STEEL AISI-316

Type RNC-316 IECEx-ATEX approved stainless steel adapter fitting, male one side, female other side, was originally developed to connect to threaded rigid conduit but can also be used with a flexible metal conduit to protect unarmoured cable in a potentially explosive atmosphere when a 45° or a 90° solution is needed. The use of stainless steel materials ensures good resistance to corrosion and chemicals in harsh environments. Connection to an Anaconda flexible conduit is made with a standard male 45°, 90°, swivel or fixed fitting which is screwed into the female thread of the adapter. Since RNA-316 cable-hose fittings are available upto 1.1/4", the RNC-316 1.1/2" to 3" adapter in combination with Anaconda stainless steel fittings can be used when larger sizes are required. Typical applications include motors, transformers, control equipment, Ex enclosures, terminal boxes and components etc., in the chemical and petrochemical, oil and gas, wood processing, bulk handling and food and pharma industries. Also available in a version for armoured cable (type RAC-316, see pages 7 - 45 till 7 - 46). On demand the version with silicone seal for high temperatures is also available.

### Material & Construction:

**Construction:** Stainless steel AISI-316 fitting, consisting of 4 parts (female body, pressure ring, sealing rubber and male body).

**Material:** Female body and male body are stainless steel AISI-316, the pressure ring is nickel plated brass and sealing rubber is from EPDM.

**Temperature:** -40 °C till +100 °C continuous. With silicone sealing rubber -65 °C till +220 °C continuous.

**Protection class:** Standard is IP 66, with a flat seal between body and switchbox IP 68.

**Colour:** Metal coloured.

For unarmoured cable, IECEx-ATEX certified and marked;  
 ▲ RCN (type) (thread size) IECEx INE 10.0010X Ex d/e I Mb IIC Gb Ex tb IIIC Db  
 Ⓢ CE 0080 INERIS 06ATEX0014X I M2 / II 2 GD, IP 66 / IP 68

RNC-316, ISO, IECEx-ATEX adapter fitting, stainless steel AISI-316, EPDM seal (-40 °C till +100 °C)



Atex fittings

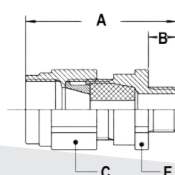

THREAD OUTER ISO	THREAD INNER NPT	CLAMPING RANGE (MM)	DIMENSIONS IN MM					STANDARD PACKAGE	ARTICLE NUMBER	WEIGHT (KG/100)
			A	B	C	D	E			
M20 x 1,5	NPT 1/2"	5,5 - 8	63	15	32	-	30	10	297.812.9	17,4
M20 x 1,5	NPT 1/2"	8 - 10,5	63	15	32	-	30	10	297.813.9	17,4
M20 x 1,5	NPT 1/2"	10,5 - 13	63	15	32	-	30	10	297.814.9	17,4
M25 x 1,5	NPT 3/4"	10,5 - 13	63	15	36	-	35	5	297.815.9	20,6
M25 x 1,5	NPT 3/4"	13 - 15,5	63	15	36	-	35	5	297.818.9	20,6
M25 x 1,5	NPT 3/4"	15,5 - 18	63	15	36	-	35	5	297.819.9	20,6
M32 x 1,5	NPT 1"	15 - 18	76	15	45	-	42	5	297.823.9	35,6
M32 x 1,5	NPT 1"	18 - 21	76	15	45	-	42	5	297.824.9	35,6
M32 x 1,5	NPT 1"	21 - 24	76	15	45	-	42	5	297.825.9	35,6
M40 x 1,5	NPT 1.1/4"	21 - 24	79	15	50	-	48	2	297.829.9	43,1
M40 x 1,5	NPT 1.1/4"	24 - 27	79	15	50	-	48	2	297.830.9	43,1
M40 x 1,5	NPT 1.1/4"	27 - 30	79	15	50	-	48	2	297.831.9	43,1
M50 x 1,5	NPT 1.1/2"	30 - 33	79	15	57	-	55	2	297.843.9	56,8
M50 x 1,5	NPT 1.1/2"	33 - 36	79	15	57	-	55	2	297.844.9	56,8
M63 x 1,5	NPT 2"	36 - 39	80	15	68	-	68	2	297.851.9	78,4
M63 x 1,5	NPT 2"	39 - 42	80	15	68	-	68	2	297.852.9	78,4
M63 x 1,5	NPT 2"	42 - 45	80	15	68	-	68	2	297.853.9	78,4

## ADAPTER IECEX-ATEX, RNC-316, IP 66 / 68, STAINLESS STEEL

For unarmoured cable, IECEX-ATEX certified and marked;

▲ RCN (type) (thread size) IECEX INE 10.0010X Ex d/e I Mb IIC Gb Ex tb IIIC Db

CE 0080 INERIS 06ATEX0014X I M2 / II 2 GD, IP 66 / IP 68

RNC-316, NPT, IECEX-ATEX adapter fitting, stainless steel AISI-316,  
EPDM seal (-40 °C till +100 °C)

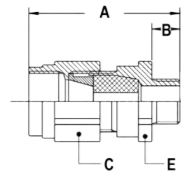

THREAD OUTER NPT	THREAD INNER NPT	CLAMPING RANGE (MM)	DIMENSIONS IN MM					STANDARD PACKAGE	ARTICLE NUMBER	WEIGHT (KG/100)
			A	B	C	D	E			
NPT 1/2"	NPT 1/2"	5,5 - 8	66	18	32	-	30	10	297.912.9	17,4
NPT 1/2"	NPT 1/2"	8 - 10,5	66	18	32	-	30	10	297.913.9	17,4
NPT 1/2"	NPT 1/2"	10,5 - 13	66	18	32	-	30	10	297.914.9	17,4
NPT 3/4"	NPT 3/4"	10,5 - 13	66	18	36	-	35	5	297.915.9	20,6
NPT 3/4"	NPT 3/4"	13 - 15,5	66	18	36	-	35	5	297.918.9	20,6
NPT 3/4"	NPT 3/4"	15,5 - 18	66	18	36	-	35	5	297.919.9	20,6
NPT 1"	NPT 1"	15 - 18	83	22	45	-	42	5	297.923.9	35,6
NPT 1"	NPT 1"	18 - 21	83	22	45	-	42	5	297.924.9	35,6
NPT 1"	NPT 1"	21 - 24	83	22	45	-	42	5	297.925.9	35,6
NPT 1.1/4"	NPT 1.1/4"	21 - 24	86	22	50	-	48	2	297.929.9	43,1
NPT 1.1/4"	NPT 1.1/4"	24 - 27	86	22	50	-	48	2	297.930.9	43,1
NPT 1.1/4"	NPT 1.1/4"	27 - 30	86	22	50	-	48	2	297.931.9	43,1
NPT 1.1/2"	NPT 1.1/2"	30 - 33	88	24	57	-	55	2	297.943.9	56,8
NPT 1.1/2"	NPT 1.1/2"	33 - 36	88	24	57	-	55	2	297.944.9	56,8
NPT 2"	NPT 2"	36 - 39	89	24	68	-	68	2	297.951.9	78,4
NPT 2"	NPT 2"	39 - 42	89	24	68	-	68	2	297.952.9	78,4
NPT 2"	NPT 2"	42 - 45	89	24	68	-	68	2	297.953.9	78,4
NPT 2.1/2"	NPT 2.1/2"	45 - 48	104	28	80	-	80	1	297.954.9	112,4
NPT 2.1/2"	NPT 2.1/2"	48 - 51	104	28	80	-	80	1	297.955.9	112,4
NPT 2.1/2"	NPT 2.1/2"	51 - 54	104	28	80	-	80	1	297.956.9	112,4
NPT 3"	NPT 3"	54 - 58	111	28	102	-	100	1	297.957.9	223,5
NPT 3"	NPT 3"	58 - 62	111	28	102	-	100	1	297.958.9	223,5

RNC-316, Pg, IECEX-ATEX adapter fitting, stainless steel AISI-316,  
EPDM seal (-40 °C till +100 °C)

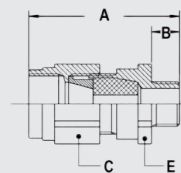

THREAD OUTER PG	THREAD INNER NPT	CLAMPING RANGE (MM)	DIMENSIONS IN MM					STANDARD PACKAGE	ARTICLE NUMBER	WEIGHT (KG/100)
			A	B	C	D	E			
Pg 11	NPT 1/2"	5,5 - 8	63	15	32	-	30	10	297.611.9	17,4
Pg 13,5	NPT 1/2"	5,5 - 8	63	15	32	-	30	10	297.612.9	17,4
Pg 13,5	NPT 1/2"	8 - 10,5	63	15	32	-	30	10	297.613.9	17,4
Pg 13,5	NPT 1/2"	10,5 - 13	63	15	32	-	30	10	297.614.9	17,4
Pg 16	NPT 3/4"	10,5 - 13	63	15	36	-	35	5	297.615.9	20,6
Pg 16	NPT 3/4"	13 - 15,5	63	15	36	-	35	5	297.618.9	20,6
Pg 16	NPT 3/4"	15,5 - 18	63	15	36	-	35	5	297.619.9	20,6
Pg 21	NPT 1"	15 - 18	76	15	45	-	42	5	297.623.9	35,6
Pg 21	NPT 1"	18 - 21	76	15	45	-	42	5	297.624.9	35,6
Pg 21	NPT 1"	21 - 24	76	15	45	-	42	5	297.625.9	35,6
Pg 29	NPT 1.1/4"	21 - 24	81	17	50	-	48	2	297.629.9	43,1
Pg 29	NPT 1.1/4"	24 - 27	81	17	50	-	48	2	297.630.9	43,1
Pg 29	NPT 1.1/4"	27 - 30	81	17	50	-	48	2	297.631.9	43,1
Pg 36	NPT 1.1/2"	30 - 33	81	17	57	-	55	2	297.643.9	56,8
Pg 36	NPT 1.1/2"	33 - 36	81	17	57	-	55	2	297.644.9	56,8
Pg 48	NPT 2"	36 - 39	83	18	68	-	68	2	297.651.9	78,4
Pg 48	NPT 2"	39 - 42	83	18	68	-	68	2	297.652.9	78,4
Pg 48	NPT 2"	42 - 45	83	18	68	-	68	2	297.653.9	78,4

# Adapter IECEx-ATEX, RAC-316, IP 66 / 68, stainless steel



For armoured cable, IECEx-ATEX certified and marked;  
 ▲ RCN (type) (thread size) IECEx INE 10.0010X Ex d/e I Mb IIC Gb Ex tb IIIC Db  
 Ⓢ CE 0080 INERIS 06ATEX0014X I M2 / II 2 GD, IP 66 / IP 68

RAC-316, ISO, IECEx-ATEX EMC adapter fitting, stainless steel  
 AISI-316, EPDM seal (-40 °C till +100 °C)

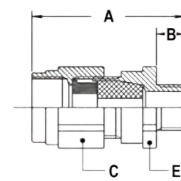

THREAD OUTER ISO	THREAD INNER NPT	CLAMPING RANGE (MM)	DIMENSIONS IN MM					STANDARD PACKAGE	ARTICLE NUMBER	WEIGHT (KG/100)
			A	B	C	D	E			
M20 x 1,5	NPT 1/2"	5,5 - 8	63	15	32	-	30	10	839.812.9	17,4
M20 x 1,5	NPT 1/2"	8 - 10,5	63	15	32	-	30	10	839.813.9	17,4
M20 x 1,5	NPT 1/2"	10,5 - 13	63	15	32	-	30	10	839.814.9	17,4
M25 x 1,5	NPT 3/4"	10,5 - 13	63	15	36	-	35	5	839.815.9	20,6
M25 x 1,5	NPT 3/4"	13 - 15,5	63	15	36	-	35	5	839.818.9	20,6
M25 x 1,5	NPT 3/4"	15,5 - 18	63	15	36	-	35	5	839.819.9	20,6
M32 x 1,5	NPT 1"	15 - 18	76	15	45	-	42	5	839.823.9	35,6
M32 x 1,5	NPT 1"	18 - 21	76	15	45	-	42	5	839.824.9	35,6
M32 x 1,5	NPT 1"	21 - 24	76	15	45	-	42	5	839.825.9	35,6
M40 x 1,5	NPT 1.1/4"	21 - 24	79	15	50	-	48	2	839.829.9	43,1
M40 x 1,5	NPT 1.1/4"	24 - 27	79	15	50	-	48	2	839.830.9	43,1
M40 x 1,5	NPT 1.1/4"	27 - 30	79	15	50	-	48	2	839.831.9	43,1
M50 x 1,5	NPT 1.1/2"	30 - 33	79	15	57	-	55	2	839.843.9	56,8
M50 x 1,5	NPT 1.1/2"	33 - 36	79	15	57	-	55	2	839.844.9	56,8
M63 x 1,5	NPT 2"	36 - 39	80	15	68	-	68	2	839.851.9	78,4
M63 x 1,5	NPT 2"	39 - 42	80	15	68	-	68	2	839.852.9	78,4
M63 x 1,5	NPT 2"	42 - 45	80	15	68	-	68	2	839.853.9	78,4
M75 x 1,5	NPT 2.1/2"	45 - 48	91	15	80	-	80	1	839.854.9	112,4
M75 x 1,5	NPT 2.1/2"	48 - 51	91	15	80	-	80	1	839.855.9	112,4
M75 x 1,5	NPT 2.1/2"	51 - 54	91	15	80	-	80	1	839.856.9	112,4
M90 x 2	NPT 3"	54 - 58	103	20	102	-	100	1	839.857.9	223,5
M90 x 2	NPT 3"	58 - 62	103	20	102	-	100	1	839.858.9	223,5

Atex fittings

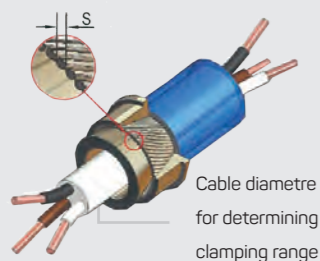

## Special information for EMC cable-hose fittings

1. In case of EMC versions, the cable diameter needed to determine the clamping range, is not the outer diameter of the cable but the diameter of the cable without the braiding.
2. In case of EMC versions with a wire diameter (S) from 1,0 till 2,5 mm (type SWA, Steel Wire Armour) a special versions with reduced cone clamping rings must be ordered (article no. with suffix "-RC").

## ADAPTER IECEX-ATEX, RAC-316, IP 66 / 68, STAINLESS STEEL

For armoured cable, IECEX-ATEX certified and marked;

▲ RCN (type) (thread size) IECEX INE 10.0010X Ex d/e I Mb IIC Gb Ex tb IIIC Db

CE 0080 INERIS 06ATEX0014X I M2 / II 2 GD, IP 66 / IP 68

RAC-316, NPT, IECEX-ATEX EMC adapter fitting, stainless steel  
AISI-316, EPDM seal (-40 °C till +100 °C)

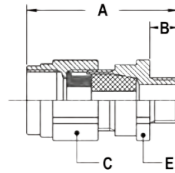

THREAD OUTER NPT	THREAD INNER NPT	CLAMPING RANGE (MM)	DIMENSIONS IN MM					STANDARD PACKAGE	ARTICLE NUMBER	WEIGHT (KG/100)
			A	B	C	D	E			
NPT 1/2"	NPT 1/2"	5,5 - 8	66	18	32	-	30	10	839.912.9	17,4
NPT 1/2"	NPT 1/2"	8 - 10,5	66	18	32	-	30	10	839.913.9	17,4
NPT 1/2"	NPT 1/2"	10,5 - 13	66	18	32	-	30	10	839.914.9	17,4
NPT 3/4"	NPT 3/4"	10,5 - 13	66	18	36	-	35	5	839.915.9	20,6
NPT 3/4"	NPT 3/4"	13 - 15,5	66	18	36	-	35	5	839.918.9	20,6
NPT 3/4"	NPT 3/4"	15,5 - 18	66	18	36	-	35	5	839.919.9	20,6
NPT 1"	NPT 1"	15 - 18	83	22	45	-	42	5	839.923.9	35,6
NPT 1"	NPT 1"	18 - 21	83	22	45	-	42	5	839.924.9	35,6
NPT 1"	NPT 1"	21 - 24	83	22	45	-	42	5	839.925.9	35,6
NPT 1.1/4"	NPT 1.1/4"	21 - 24	86	22	50	-	48	2	839.929.9	43,1
NPT 1.1/4"	NPT 1.1/4"	24 - 27	86	22	50	-	48	2	839.930.9	43,1
NPT 1.1/4"	NPT 1.1/4"	27 - 30	86	22	50	-	48	2	839.931.9	43,1
NPT 1.1/2"	NPT 1.1/2"	30 - 33	88	24	57	-	55	2	839.943.9	56,8
NPT 1.1/2"	NPT 1.1/2"	33 - 36	88	24	57	-	55	2	839.944.9	56,8
NPT 2"	NPT 2"	36 - 39	89	24	68	-	68	2	839.951.9	78,4
NPT 2"	NPT 2"	39 - 42	89	24	68	-	68	2	839.952.9	78,4
NPT 2"	NPT 2"	42 - 45	89	24	68	-	68	2	839.953.9	78,4
NPT 2.1/2"	NPT 2.1/2"	45 - 48	104	28	80	-	80	1	839.954.9	112,4
NPT 2.1/2"	NPT 2.1/2"	48 - 51	104	28	80	-	80	1	839.955.9	112,4
NPT 2.1/2"	NPT 2.1/2"	51 - 54	104	28	80	-	80	1	839.956.9	112,4
NPT 3"	NPT 3"	54 - 58	111	28	102	-	100	1	839.957.9	223,5
NPT 3"	NPT 3"	58 - 62	111	28	102	-	100	1	839.958.9	223,5

RAC-316, Pg, IECEX-ATEX EMC adapter fitting, stainless steel  
AISI-316, EPDM seal (-40 °C till +100 °C)

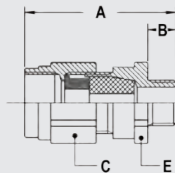

THREAD OUTER PG	THREAD INNER NPT	CLAMPING RANGE (MM)	DIMENSIONS IN MM					STANDARD PACKAGE	ARTICLE NUMBER	WEIGHT (KG/100)
			A	B	C	D	E			
Pg 11	NPT 1/2"	5,5 - 8	63	15	32	-	30	10	839.611.9	17,4
Pg 13,5	NPT 1/2"	5,5 - 8	63	15	32	-	30	10	839.612.9	17,4
Pg 13,5	NPT 1/2"	8 - 10,5	63	15	32	-	30	10	839.613.9	17,4
Pg 13,5	NPT 1/2"	10,5 - 13	63	15	32	-	30	10	839.614.9	17,4
Pg 16	NPT 3/4"	10,5 - 13	63	15	36	-	35	5	839.615.9	20,6
Pg 16	NPT 3/4"	13 - 15,5	63	15	36	-	35	5	839.618.9	20,6
Pg 16	NPT 3/4"	15,5 - 18	63	15	36	-	35	5	839.619.9	20,6
Pg 21	NPT 1"	15 - 18	76	15	45	-	42	5	839.623.9	35,6
Pg 21	NPT 1"	18 - 21	76	15	45	-	42	5	839.624.9	35,6
Pg 21	NPT 1"	21 - 24	76	15	45	-	42	5	839.625.9	35,6
Pg 29	NPT 1.1/4"	21 - 24	81	17	50	-	48	2	839.629.9	43,1
Pg 29	NPT 1.1/4"	24 - 27	81	17	50	-	48	2	839.630.9	43,1
Pg 29	NPT 1.1/4"	27 - 30	81	17	50	-	48	2	839.631.9	43,1
Pg 36	NPT 1.1/2"	30 - 33	81	17	57	-	55	2	839.643.9	56,8
Pg 36	NPT 1.1/2"	33 - 36	81	17	57	-	55	2	839.644.9	56,8
Pg 48	NPT 2"	36 - 39	83	18	68	-	68	2	839.651.9	78,4
Pg 48	NPT 2"	39 - 42	83	18	68	-	68	2	839.652.9	78,4
Pg 48	NPT 2"	42 - 45	83	18	68	-	68	2	839.653.9	78,4

# Adapter IECEx-ATEX, RNC-316, IP 66 / 68, stainless steel

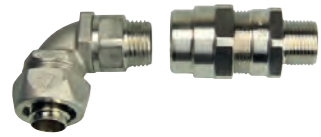

## ANACONDA FITTINGS, STAINLESS STEEL AISI-316, FOR COMBINATION WITH ADAPTER RNC-316 / RAC-316

The connection with an Anaconda conduit is made by screwing a stainless steel Anaconda 45° or 90° swivel fitting illustrated hereunder, or 45° or 90° fixed fitting (illustrated on chapter 5) into the female thread of the adapter. Because RNA-316 and RAA-316 cable-hose fittings are available only till 1.1/4", if a straight solution for larger sizes is needed, it is also possible to use the RNC-316 and RAA-316 adapter from 1.1/2" up to 3" size in combination with Anaconda stainless steel AISI-316 straight fittings.

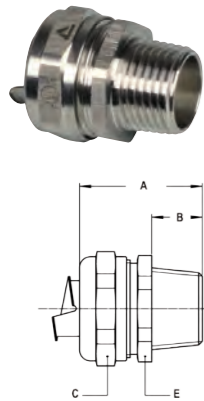

NPT straight fitting, compact, male, stainless steel AISI-316



THREAD NPT	SEALTITE SIZE (INCH)	MIN. INTERNAL BORE (MM)	DIMENSIONS IN MM					STANDARD PACKAGE	ARTICLE NUMBER	WEIGHT (KG/100)
			A	B	C	D	E			
NPT 1/2"	3/8"	11	35	14	26	-	24	10	714.112.9	4,4
NPT 1/2"	1/2"	14,5	36	14	29	-	27	10	714.116.9	5
NPT 3/4"	3/4"	19,4	37	14	35	-	33	5	714.120.9	7
NPT 1"	1"	24,7	40	16	45	-	42	5	714.126.9	12,6
NPT 1.1/4"	1.1/4"	33,3	43	16	53	-	50	2	714.135.9	16,8
NPT 1.1/2"	1.1/2"	38	50	18	62	-	58	2	714.140.9	25,8
NPT 2"	2"	49	56	20	76	-	72	2	714.150.9	41,2
NPT 2.1/2"	2.1/2"	60,7	67	25	90	-	85	1	714.163.9*	83,6
NPT 3"	3"	75,5	73	27	108	-	102	1	714.175.9*	113,9

\* Size NPT 2.1/2" and NPT 3" are without UL / CSA.

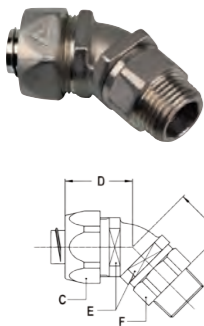

NPT 45° swivel fitting, male, stainless steel AISI-316



Atex fittings

THREAD NPT	SEALTITE SIZE (INCH)	MIN. INTERNAL BORE (MM)	DIMENSIONS IN MM						STANDARD PACKAGE	ARTICLE NUMBER	WEIGHT (KG/100)
			A	B	C	D	E	F			
NPT 1/2"	3/8"	10,4	36	12	27	28	22	22	10	819.212.9	11,5
NPT 1/2"	1/2"	13,8	36	12	30	30	27	25	10	819.216.9	14
NPT 3/4"	3/4"	17,4	47	14	36	37	33	33	5	838.220.9	22
NPT 1"	1"	23,4	54	15	46	46	42	42	5	838.226.9	37

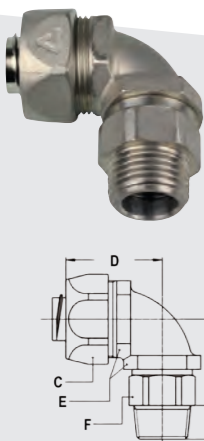

NPT 90° swivel fitting, male, stainless steel AISI-316



THREAD NPT	SEALTITE SIZE (INCH)	MIN. INTERNAL BORE (MM)	DIMENSIONS IN MM						STANDARD PACKAGE	ARTICLE NUMBER	WEIGHT (KG/100)
			A	B	C	D	E	F			
NPT 1/2"	3/8"	10,4	41	12	27	35	22	22	10	819.512.9	12
NPT 1/2"	1/2"	13,8	41	12	30	37	27	25	10	819.516.9	14
NPT 3/4"	3/4"	17,4	60	14	36	50	33	33	5	838.520.9	23,5
NPT 1"	1"	23,4	102	15	46	60	42	42	5	838.526.9	42



# Adapter IECEx-ATEX, BNC, IP 66 / 68, nickel plated brass



## ANAMET IECEx-ATEX BARRIER ADAPTER FITTING, TYPE BNC AND BAC, NICKEL PLATED BRASS

Type BNC IECEx-ATEX approved nickel plated brass barrier adapter fitting, male one side, female other side, is used with a flexible metal conduit to provide protection to an unarmoured cable (stripped), when a barrier 45° or 90° solution is needed. Connection to an Anaconda conduit is made with a standard male, 45° or 90° Anaconda swivel or fixed fitting which is screwed into the female thread of the adapter. Since BNA cable-hose fittings are available only till 1.1/4", the BNC 1.1/2" to 3" adapters in combination with Anaconda standard fittings can be used when larger sizes are required. Typical applications include motors, transformers, control equipment, Ex enclosures, terminal boxes and components etc., in the chemical and petrochemical, oil and gas, wood processing, bulk handling and food and pharma industries. Also available in a version for armoured cable (type BAC, pages 7 - 50 till 7 - 51). On demand the version with silicone seal for high temperatures is also available.

### Material & Construction:

**Construction:** Nickel plated brass fitting, consisting of 6 parts (female body, (double) pressure ring, sealing rubber, barrier container and male body). Separately, a 2 component epoxy resin is supplied for creating the barrier.

**Material:** Female body, pressure ring, barrier container and male body are nickel plated brass and sealing rubber is from EPDM. Also

available in stainless steel AISI-316.

**Temperature:** -40 °C till +100 °C continuous. With silicone sealing rubber -60 °C till +150 °C continuous.

**Protection class:** Standard is IP 66, with a flat seal between body and switchbox IP 68.

**Colour:** Metal coloured.

For unarmoured cable (stripped), IECEx-ATEX certified and marked;  
 ▲ RCN (type) (thread size) IECEx INE 10.0010X Ex d/e I Mb IIC Gb Ex tb IIIC Db  
 ⚡ CE 0080 INERIS 06ATEX0014X I M2 / II 2 GD, IP 66 / IP 68

BNC, ISO, IECEx-ATEX barrier adapter fitting, nickel plated brass, EPDM and epoxy seal (-40 °C till +100 °C)

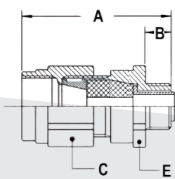

THREAD OUTER ISO	THREAD INNER NPT	CLAMPING RANGE (MM)	DIMENSIONS IN MM					STANDARD PACKAGE	ARTICLE NUMBER	WEIGHT (KG/100)
			A	B	C	D	E			
M20 x 1,5	NPT 1/2"	5,5 - 8	63	15	32	-	30	10	823.812.0	17,4
M20 x 1,5	NPT 1/2"	8 - 10,5	63	15	32	-	30	10	823.813.0	17,4
M20 x 1,5	NPT 1/2"	10,5 - 13	63	15	32	-	30	10	823.814.0	17,4
M25 x 1,5	NPT 3/4"	10,5 - 13	63	15	36	-	35	5	823.815.0	20,6
M25 x 1,5	NPT 3/4"	13 - 15,5	63	15	36	-	35	5	823.818.0	20,6
M25 x 1,5	NPT 3/4"	15,5 - 18	63	15	36	-	35	5	823.819.0	20,6
M32 x 1,5	NPT 1"	15 - 18	76	15	45	-	42	5	823.823.0	35,6
M32 x 1,5	NPT 1"	18 - 21	76	15	45	-	42	5	823.824.0	35,6
M32 x 1,5	NPT 1"	21 - 24	76	15	45	-	42	5	823.825.0	35,6
M40 x 1,5	NPT 1.1/4"	21 - 24	79	15	50	-	48	2	823.829.0	43,1
M40 x 1,5	NPT 1.1/4"	24 - 27	79	15	50	-	48	2	823.830.0	43,1
M40 x 1,5	NPT 1.1/4"	27 - 30	79	15	50	-	48	2	823.831.0	43,1
M50 x 1,5	NPT 1.1/2"	30 - 33	79	15	57	-	55	2	823.843.0	56,8
M50 x 1,5	NPT 1.1/2"	33 - 36	79	15	57	-	55	2	823.844.0	56,8
M63 x 1,5	NPT 2"	36 - 39	80	15	68	-	68	2	823.851.0	78,4
M63 x 1,5	NPT 2"	39 - 42	80	15	68	-	68	2	823.852.0	78,4
M63 x 1,5	NPT 2"	42 - 45	80	15	68	-	68	2	823.853.0	78,4
M75 x 1,5	NPT 2.1/2"	45 - 48	91	15	80	-	80	1	823.854.0	112,4
M75 x 1,5	NPT 2.1/2"	48 - 51	91	15	80	-	80	1	823.855.0	112,4
M75 x 1,5	NPT 2.1/2"	51 - 54	91	15	80	-	80	1	823.856.0	112,4
M90 x 2	NPT 3"	54 - 58	103	20	102	-	100	1	823.857.0	223,5
M90 x 2	NPT 3"	58 - 62	103	20	102	-	100	1	823.858.0	223,5

## ADAPTER IECEX-ATEX, BNC, IP 66 / 68, NICKEL PLATED BRASS

For unarmoured cable, IECEX-ATEX certified and marked;

▲ RCN (type) (thread size) IECEX INE 10.0010X Ex d/e I Mb IIC Gb Ex tb IIIC Db

CE 0080 INERIS 06ATEX0014X I M2 / II 2 GD, IP 66 / IP 68

BNC, NPT, IECEX-ATEX barrier adapter fitting, nickel plated brass, EPDM and epoxy seal (-40 °C till +100 °C)

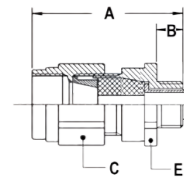

THREAD OUTER NPT	THREAD INNER NPT	CLAMPING RANGE (MM)	DIMENSIONS IN MM					STANDARD PACKAGE	ARTICLE NUMBER	WEIGHT (KG/100)
			A	B	C	D	E			
NPT 1/2"	NPT 1/2"	5,5 - 8	66	18	32	-	30	10	823.912.0	17,4
NPT 1/2"	NPT 1/2"	8 - 10,5	66	18	32	-	30	10	823.913.0	17,4
NPT 1/2"	NPT 1/2"	10,5 - 13	66	18	32	-	30	10	823.914.0	17,4
NPT 3/4"	NPT 3/4"	10,5 - 13	66	18	36	-	35	5	823.915.0	20,6
NPT 3/4"	NPT 3/4"	13 - 15,5	66	18	36	-	35	5	823.918.0	20,6
NPT 3/4"	NPT 3/4"	15,5 - 18	66	18	36	-	35	5	823.919.0	20,6
NPT 1"	NPT 1"	15 - 18	83	22	45	-	42	5	823.923.0	35,6
NPT 1"	NPT 1"	18 - 21	83	22	45	-	42	5	823.924.0	35,6
NPT 1"	NPT 1"	21 - 24	83	22	45	-	42	5	823.925.0	35,6
NPT 1.1/4"	NPT 1.1/4"	21 - 24	86	22	50	-	48	2	823.929.0	43,1
NPT 1.1/4"	NPT 1.1/4"	24 - 27	86	22	50	-	48	2	823.930.0	43,1
NPT 1.1/4"	NPT 1.1/4"	27 - 30	86	22	50	-	48	2	823.931.0	43,1
NPT 1.1/2"	NPT 1.1/2"	30 - 33	88	24	57	-	55	2	823.943.0	56,8
NPT 1.1/2"	NPT 1.1/2"	33 - 36	88	24	57	-	55	2	823.944.0	56,8
NPT 2"	NPT 2"	36 - 39	89	24	68	-	68	2	823.951.0	78,4
NPT 2"	NPT 2"	39 - 42	89	24	68	-	68	2	823.952.0	78,4
NPT 2"	NPT 2"	42 - 45	89	24	68	-	68	2	823.953.0	78,4
NPT 2.1/2"	NPT 2.1/2"	45 - 48	104	28	80	-	80	1	823.954.0	112,4
NPT 2.1/2"	NPT 2.1/2"	48 - 51	104	28	80	-	80	1	823.955.0	112,4
NPT 2.1/2"	NPT 2.1/2"	51 - 54	104	28	80	-	80	1	823.956.0	112,4
NPT 3"	NPT 3"	54 - 58	111	28	102	-	100	1	823.957.0	223,5
NPT 3"	NPT 3"	58 - 62	111	28	102	-	100	1	823.958.0	223,5

Atex fittings

BNC, Pg, IECEX-ATEX barrier adapter fitting, nickel plated brass, EPDM and epoxy seal (-40 °C till +100 °C)

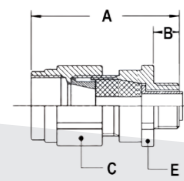

THREAD OUTER PG	THREAD INNER NPT	CLAMPING RANGE (MM)	DIMENSIONS IN MM					STANDARD PACKAGE	ARTICLE NUMBER	WEIGHT (KG/100)
			A	B	C	D	E			
Pg 11	NPT 1/2"	5,5 - 8	63	15	32	-	30	10	823.611.0	17,4
Pg 13,5	NPT 1/2"	5,5 - 8	63	15	32	-	30	10	823.612.0	17,4
Pg 13,5	NPT 1/2"	8 - 10,5	63	15	32	-	30	10	823.613.0	17,4
Pg 13,5	NPT 1/2"	10,5 - 13	63	15	32	-	30	10	823.614.0	17,4
Pg 16	NPT 3/4"	10,5 - 13	63	15	36	-	35	5	823.615.0	20,6
Pg 16	NPT 3/4"	13 - 15,5	63	15	36	-	35	5	823.618.0	20,6
Pg 16	NPT 3/4"	15,5 - 18	63	15	36	-	35	5	823.619.0	20,6
Pg 21	NPT 1"	15 - 18	76	15	45	-	42	5	823.623.0	35,6
Pg 21	NPT 1"	18 - 21	76	15	45	-	42	5	823.624.0	35,6
Pg 21	NPT 1"	21 - 24	76	15	45	-	42	5	823.625.0	35,6
Pg 29	NPT 1.1/4"	21 - 24	81	17	50	-	48	2	823.629.0	43,1
Pg 29	NPT 1.1/4"	24 - 27	81	17	50	-	48	2	823.630.0	43,1
Pg 29	NPT 1.1/4"	27 - 30	81	17	50	-	48	2	823.631.0	43,1
Pg 36	NPT 1.1/2"	30 - 33	81	17	57	-	55	2	823.643.0	56,8
Pg 36	NPT 1.1/2"	33 - 36	81	17	57	-	55	2	823.644.0	56,8
Pg 48	NPT 2"	36 - 39	83	18	68	-	68	2	823.651.0	78,4
Pg 48	NPT 2"	39 - 42	83	18	68	-	68	2	823.652.0	78,4
Pg 48	NPT 2"	42 - 45	83	18	68	-	68	2	823.653.0	78,4

# Adapter IECEx-ATEX, BAC, IP 66 / 68, nickel plated brass



For armoured cable, IECEx-ATEX certified and marked;  
 ▲ RCN (type) (thread size) IECEx INE 10.0010X Ex d/e I Mb IIC Gb Ex tb IIIC Db  
 Ⓢ CE 0080 INERIS 06ATEX0014X I M2 / II 2 GD, IP 66 / IP 68

BAC, ISO, IECEx-ATEX EMC barrier adapter fitting nickel plated brass,  
 EPDM and epoxy seal (-40 °C till +100 °C)

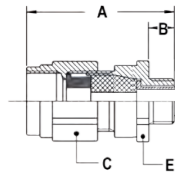

THREAD OUTER ISO	THREAD INNER NPT	CLAMPING RANGE (MM)	DIMENSIONS IN MM					STANDARD PACKAGE	ARTICLE NUMBER	WEIGHT (KG/100)
			A	B	C	D	E			
M20 x 1,5	NPT 1/2"	5,5 - 8	63	15	32	-	30	10	723.812.0	17,4
M20 x 1,5	NPT 1/2"	8 - 10,5	63	15	32	-	30	10	723.813.0	17,4
M20 x 1,5	NPT 1/2"	10,5 - 13	63	15	32	-	30	10	723.814.0	17,4
M25 x 1,5	NPT 3/4"	10,5 - 13	63	15	36	-	35	5	723.815.0	20,6
M25 x 1,5	NPT 3/4"	13 - 15,5	63	15	36	-	35	5	723.818.0	20,6
M25 x 1,5	NPT 3/4"	15,5 - 18	63	15	36	-	35	5	723.819.0	20,6
M32 x 1,5	NPT 1"	15 - 18	76	15	45	-	42	5	723.823.0	35,6
M32 x 1,5	NPT 1"	18 - 21	76	15	45	-	42	5	723.824.0	35,6
M32 x 1,5	NPT 1"	21 - 24	76	15	45	-	42	5	723.825.0	35,6
M40 x 1,5	NPT 1.1/4"	21 - 24	79	15	50	-	48	2	723.829.0	43,1
M40 x 1,5	NPT 1.1/4"	24 - 27	79	15	50	-	48	2	723.830.0	43,1
M40 x 1,5	NPT 1.1/4"	27 - 30	79	15	50	-	48	2	723.831.0	43,1
M50 x 1,5	NPT 1.1/2"	30 - 33	79	15	57	-	55	2	723.843.0	56,8
M50 x 1,5	NPT 1.1/2"	33 - 36	79	15	57	-	55	2	723.844.0	56,8
M63 x 1,5	NPT 2"	36 - 39	80	15	68	-	68	2	723.851.0	78,4
M63 x 1,5	NPT 2"	39 - 42	80	15	68	-	68	2	723.852.0	78,4
M63 x 1,5	NPT 2"	42 - 45	80	15	68	-	68	2	723.853.0	78,4
M75 x 1,5	NPT 2.1/2"	45 - 48	91	15	80	-	80	1	723.854.0	112,4
M75 x 1,5	NPT 2.1/2"	48 - 51	91	15	80	-	80	1	723.855.0	112,4
M75 x 1,5	NPT 2.1/2"	51 - 54	91	15	80	-	80	1	723.856.0	112,4
M90 x 2	NPT 3"	54 - 58	103	20	102	-	100	1	723.857.0	223,5
M90 x 2	NPT 3"	58 - 62	103	20	102	-	100	1	723.858.0	223,5

## Special information for EMC cable-hose fittings

1. In case of EMC versions, the cable diameter needed to determine the clamping range, is not the outer diameter of the cable but the diameter of the cable without the braiding.
2. In case of EMC versions with a wire diameter (S) from 1,0 till 2,5 mm (type SWA, Steel Wire Armour) a special version with reduced cone clamping rings must be ordered (article no. with suffix "-RC").

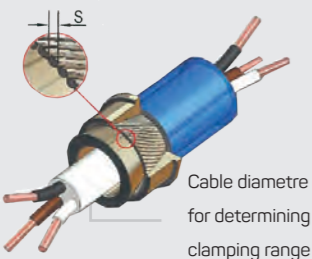

## ADAPTER IECEX-ATEX, BAC, IP 66 / 68, NICKEL PLATED BRASS

For armoured cable, IECEX-ATEX certified and marked;

▲ RCN (type) (thread size) IECEX INE 10.0010X Ex d/e I Mb IIC Gb Ex tb IIIC Db

CE 0080 INERIS 06ATEX0014X I M2 / II 2 GD, IP 66 / IP 68

BAC, NPT, IECEX-ATEX EMC barrier adapter fitting, nickel plated brass, EPDM and epoxy seal (-40 °C till +100 °C)

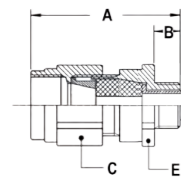

THREAD OUTER NPT	THREAD INNER NPT	CLAMPING RANGE (MM)	DIMENSIONS IN MM					STANDARD PACKAGE	ARTICLE NUMBER	WEIGHT (KG/100)
			A	B	C	D	E			
NPT 1/2"	NPT 1/2"	5,5 - 8	66	18	32	-	30	10	723.912.0	17,4
NPT 1/2"	NPT 1/2"	8 - 10,5	66	18	32	-	30	10	723.913.0	17,4
NPT 1/2"	NPT 1/2"	10,5 - 13	66	18	32	-	30	10	723.914.0	17,4
NPT 3/4"	NPT 3/4"	10,5 - 13	66	18	36	-	35	5	723.915.0	20,6
NPT 3/4"	NPT 3/4"	13 - 15,5	66	18	36	-	35	5	723.918.0	20,6
NPT 3/4"	NPT 3/4"	15,5 - 18	66	18	36	-	35	5	723.919.0	20,6
NPT 1"	NPT 1"	15 - 18	83	22	45	-	42	5	723.923.0	35,6
NPT 1"	NPT 1"	18 - 21	83	22	45	-	42	5	723.924.0	35,6
NPT 1"	NPT 1"	21 - 24	83	22	45	-	42	5	723.925.0	35,6
NPT 1.1/4"	NPT 1.1/4"	21 - 24	86	22	50	-	48	2	723.929.0	43,1
NPT 1.1/4"	NPT 1.1/4"	24 - 27	86	22	50	-	48	2	723.930.0	43,1
NPT 1.1/4"	NPT 1.1/4"	27 - 30	86	22	50	-	48	2	723.931.0	43,1
NPT 1.1/2"	NPT 1.1/2"	30 - 33	88	24	57	-	55	2	723.943.0	56,8
NPT 1.1/2"	NPT 1.1/2"	33 - 36	88	24	57	-	55	2	723.944.0	56,8
NPT 2"	NPT 2"	36 - 39	89	24	68	-	68	2	723.951.0	78,4
NPT 2"	NPT 2"	39 - 42	89	24	68	-	68	2	723.952.0	78,4
NPT 2"	NPT 2"	42 - 45	89	24	68	-	68	2	723.953.0	78,4
NPT 2.1/2"	NPT 2.1/2"	45 - 48	104	28	80	-	80	1	723.954.0	112,4
NPT 2.1/2"	NPT 2.1/2"	48 - 51	104	28	80	-	80	1	723.955.0	112,4
NPT 2.1/2"	NPT 2.1/2"	51 - 54	104	28	80	-	80	1	723.956.0	112,4
NPT 3"	NPT 3"	54 - 58	111	28	102	-	100	1	723.957.0	223,5
NPT 3"	NPT 3"	58 - 62	111	28	102	-	100	1	723.958.0	223,5

Atex fittings

BAC, Pg, IECEX-ATEX EMC barrier adapter fitting, nickel plated brass, EPDM and epoxy seal (-40 °C till +100 °C)

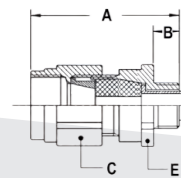

THREAD OUTER PG	THREAD INNER NPT	CLAMPING RANGE (MM)	DIMENSIONS IN MM					STANDARD PACKAGE	ARTICLE NUMBER	WEIGHT (KG/100)
			A	B	C	D	E			
Pg 11	NPT 1/2"	5,5 - 8	63	15	32	-	30	10	723.611.0	17,4
Pg 13,5	NPT 1/2"	5,5 - 8	63	15	32	-	30	10	723.612.0	17,4
Pg 13,5	NPT 1/2"	8 - 10,5	63	15	32	-	30	10	723.613.0	17,4
Pg 13,5	NPT 1/2"	10,5 - 13	63	15	32	-	30	10	723.614.0	17,4
Pg 16	NPT 3/4"	10,5 - 13	63	15	36	-	35	5	723.615.0	20,6
Pg 16	NPT 3/4"	13 - 15,5	63	15	36	-	35	5	723.618.0	20,6
Pg 16	NPT 3/4"	15,5 - 18	63	15	36	-	35	5	723.619.0	20,6
Pg 21	NPT 1"	15 - 18	76	15	45	-	42	5	723.623.0	35,6
Pg 21	NPT 1"	18 - 21	76	15	45	-	42	5	723.624.0	35,6
Pg 21	NPT 1"	21 - 24	76	15	45	-	42	5	723.625.0	35,6
Pg 29	NPT 1.1/4"	21 - 24	81	17	50	-	48	2	723.629.0	43,1
Pg 29	NPT 1.1/4"	24 - 27	81	17	50	-	48	2	723.630.0	43,1
Pg 29	NPT 1.1/4"	27 - 30	81	17	50	-	48	2	723.631.0	43,1
Pg 36	NPT 1.1/2"	30 - 33	81	17	57	-	55	2	723.643.0	56,8
Pg 36	NPT 1.1/2"	33 - 36	81	17	57	-	55	2	723.644.0	56,8
Pg 48	NPT 2"	36 - 39	83	18	68	-	68	2	723.651.0	78,4
Pg 48	NPT 2"	39 - 42	83	18	68	-	68	2	723.652.0	78,4
Pg 48	NPT 2"	42 - 45	83	18	68	-	68	2	723.653.0	78,4

# Adapter IECEx-ATEX, BNC-316, IP 66 / 68, stainless steel



## ANAMET IECEx-ATEX BARRIER ADAPTER FITTING, TYPE BNC-316 AND BAC-316, STAINLESS STEEL AISI-316

Type BNC-316 IECEx-ATEX approved stainless steel barrier adapter fitting, male one side, female other side, is used with a flexible metal conduit to provide mechanical protection of to an unarmoured cable (stripped), when a barrier 45° or 90° solution is needed. The use of stainless steel materials ensures good resistance to corrosion and chemicals in harsh environments. Connection to an Anaconda conduit is made with a standard male, 45°, 90°, stainless steel swivel or fixed fitting which is screwed into the female thread of the adapter. Since BNA-316 cable-hose fittings are available only till 1.1/4", the BNC-316 1.1/2" to 3" adapters in combination with Anaconda stainless steel fittings can be used when larger sizes are required. Typical applications include motors, transformers, control equipment, Ex enclosures, terminal boxes and components etc., in the chemical and petrochemical, oil and gas, wood processing, bulk handling and food and pharma industries. Also available in a version for armoured cable (type BAC-316, pages 7 - 54 till 7 - 55). On demand the version with silicone seal for high temperatures is also available.

### Material & Construction:

**Construction:** Stainless steel AISI-316 fitting, consisting of 6 parts (female body, double pressure ring, sealing rubber, barrier container and male body). Separately, a 2 component epoxy resin is supplied for creating the barrier.

**Material:** Female body and male body are stainless steel AISI-316. The double pressure ring and barrier container are nickel plated brass and sealing rubber is from EPDM. Also available in nickel plated brass.

**Temperature:** -40 °C till +100 °C continuous. With silicone sealing rubber -60 °C till +120 °C continuous.

**Protection class:** Standard is IP 66, with a flat seal between body and switchbox IP 68.

**Colour:** Metal coloured.

For unarmoured cable (stripped), IECEx-ATEX certified and marked;  
 ▲ RCN (type) (thread size) IECEx INE 10.0010X Ex d/e I Mb IIC Gb Ex tb IIIC Db  
 Ⓢ CE 0080 INERIS 06ATEX0014X I M2 / II 2 GD, IP 66 / IP 68

BNC-316, ISO, IECEx-ATEX, barrier adapter fitting, stainless steel AISI-316, EPDM and epoxy seal (-40 °C till +100 °C)

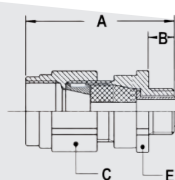

THREAD OUTER ISO	THREAD INNER NPT	CLAMPING RANGE (MM)	DIMENSIONS IN MM					STANDARD PACKAGE	ARTICLE NUMBER	WEIGHT (KG/100)
			A	B	C	D	E			
M20 x 1,5	NPT 1/2"	5,5 - 8	63	15	32	-	30	10	823.812.9	17,4
M20 x 1,5	NPT 1/2"	8 - 10,5	63	15	32	-	30	10	823.813.9	17,4
M20 x 1,5	NPT 1/2"	10,5 - 13	63	15	32	-	30	10	823.814.9	17,4
M25 x 1,5	NPT 3/4"	10,5 - 13	63	15	36	-	35	5	823.815.9	20,6
M25 x 1,5	NPT 3/4"	13 - 15,5	63	15	36	-	35	5	823.818.9	20,6
M25 x 1,5	NPT 3/4"	15,5 - 18	63	15	36	-	35	5	823.819.9	20,6
M32 x 1,5	NPT 1"	15 - 18	76	15	45	-	42	5	823.823.9	35,6
M32 x 1,5	NPT 1"	18 - 21	76	15	45	-	42	5	823.824.9	35,6
M32 x 1,5	NPT 1"	21 - 24	76	15	45	-	42	5	823.825.9	35,6
M40 x 1,5	NPT 1.1/4"	21 - 24	79	15	50	-	48	2	823.829.9	43,1
M40 x 1,5	NPT 1.1/4"	24 - 27	79	15	50	-	48	2	823.830.9	43,1
M40 x 1,5	NPT 1.1/4"	27 - 30	79	15	50	-	48	2	823.831.9	43,1
M50 x 1,5	NPT 1.1/2"	30 - 33	79	15	57	-	55	1	823.843.9	56,8
M50 x 1,5	NPT 1.1/2"	33 - 36	79	15	57	-	55	1	823.844.9	56,8
M63 x 1,5	NPT 2"	36 - 39	80	15	68	-	68	1	823.851.9	78,4
M63 x 1,5	NPT 2"	39 - 42	80	15	68	-	68	1	823.852.9	78,4
M63 x 1,5	NPT 2"	42 - 45	80	15	68	-	68	1	823.853.9	78,4

## ADAPTER IECEX-ATEX, BNC-316, IP 66 / 68, STAINLESS STEEL

For unarmoured cable (stripped), IECEX-ATEX certified and marked;  
 ▲ RCN (type) (thread size) IECEX INE 10.0010X Ex d/e I Mb IIC Gb Ex tb IIIC Db  
 CE 0080 INERIS 06ATEX0014X I M2 / II 2 GD, IP 66 / IP 68

BNC-316, NPT, IECEX-ATEX, barrier adapter fitting, stainless steel  
 AISI-316, EPDM and epoxy seal (-40 °C till +100 °C)

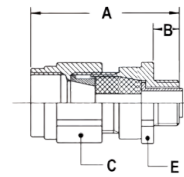

THREAD OUTER NPT	THREAD INNER NPT	CLAMPING RANGE (MM)	DIMENSIONS IN MM					STANDARD PACKAGE	ARTICLE NUMBER	WEIGHT (KG/100)
			A	B	C	D	E			
NPT 1/2"	NPT 1/2"	5,5 - 8	66	18	32	-	30	10	823.912.9	17,4
NPT 1/2"	NPT 1/2"	8 - 10,5	66	18	32	-	30	10	823.913.9	17,4
NPT 1/2"	NPT 1/2"	10,5 - 13	66	18	32	-	30	10	823.914.9	17,4
NPT 3/4"	NPT 3/4"	10,5 - 13	66	18	36	-	35	5	823.915.9	20,6
NPT 3/4"	NPT 3/4"	13 - 15,5	66	18	36	-	35	5	823.918.9	20,6
NPT 3/4"	NPT 3/4"	15,5 - 18	66	18	36	-	35	5	823.919.9	20,6
NPT 1"	NPT 1"	15 - 18	83	22	45	-	42	5	823.923.9	35,6
NPT 1"	NPT 1"	18 - 21	83	22	45	-	42	5	823.924.9	35,6
NPT 1"	NPT 1"	21 - 24	83	22	45	-	42	5	823.925.9	35,6
NPT 1.1/4"	NPT 1.1/4"	21 - 24	86	22	50	-	48	2	823.929.9	43,1
NPT 1.1/4"	NPT 1.1/4"	24 - 27	86	22	50	-	48	2	823.930.9	43,1
NPT 1.1/4"	NPT 1.1/4"	27 - 30	86	22	50	-	48	2	823.931.9	43,1
NPT 1.1/2"	NPT 1.1/2"	30 - 33	88	24	57	-	55	2	823.943.9	56,8
NPT 1.1/2"	NPT 1.1/2"	33 - 36	88	24	57	-	55	2	823.944.9	56,8
NPT 2"	NPT 2"	36 - 39	89	24	68	-	68	2	823.951.9	78,4
NPT 2"	NPT 2"	39 - 42	89	24	68	-	68	2	823.952.9	78,4
NPT 2"	NPT 2"	42 - 45	89	24	68	-	68	2	823.953.9	78,4
NPT 2.1/2"	NPT 2.1/2"	45 - 48	104	28	80	-	80	1	823.954.9	112,4
NPT 2.1/2"	NPT 2.1/2"	48 - 51	104	28	80	-	80	1	823.955.9	112,4
NPT 2.1/2"	NPT 2.1/2"	51 - 54	104	28	80	-	80	1	823.956.9	112,4
NPT 3"	NPT 3"	54 - 58	111	28	102	-	100	1	823.957.9	223,5
NPT 3"	NPT 3"	58 - 62	111	28	102	-	100	1	823.958.9	223,5

Atex fittings

BNC-316, Pg, IECEX-ATEX, barrier adapter fitting, stainless steel  
 AISI-316, EPDM and epoxy seal (-40 °C till +100 °C)

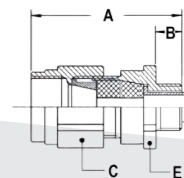

THREAD OUTER PG	THREAD INNER NPT	CLAMPING RANGE (MM)	DIMENSIONS IN MM					STANDARD PACKAGE	ARTICLE NUMBER	WEIGHT (KG/100)
			A	B	C	D	E			
Pg 11	NPT 1/2"	5,5 - 8	63	15	32	-	30	10	823.611.9	17,4
Pg 13,5	NPT 1/2"	5,5 - 8	63	15	32	-	30	10	823.612.9	17,4
Pg 13,5	NPT 1/2"	8 - 10,5	63	15	32	-	30	10	823.613.9	17,4
Pg 13,5	NPT 1/2"	10,5 - 13	63	15	32	-	30	10	823.614.9	17,4
Pg 16	NPT 3/4"	10,5 - 13	63	15	36	-	35	5	823.615.9	20,6
Pg 16	NPT 3/4"	13 - 15,5	63	15	36	-	35	5	823.618.9	20,6
Pg 16	NPT 3/4"	15,5 - 18	63	15	36	-	35	5	823.619.9	20,6
Pg 21	NPT 1"	15 - 18	76	15	45	-	42	5	823.623.9	35,6
Pg 21	NPT 1"	18 - 21	76	15	45	-	42	5	823.624.9	35,6
Pg 21	NPT 1"	21 - 24	76	15	45	-	42	5	823.625.9	35,6
Pg 29	NPT 1.1/4"	21 - 24	81	17	50	-	48	2	823.629.9	43,1
Pg 29	NPT 1.1/4"	24 - 27	81	17	50	-	48	2	823.630.9	43,1
Pg 29	NPT 1.1/4"	27 - 30	81	17	50	-	48	2	823.631.9	43,1
Pg 36	NPT 1.1/2"	30 - 33	81	17	57	-	55	2	823.643.9	56,8
Pg 36	NPT 1.1/2"	33 - 36	81	17	57	-	55	2	823.644.9	56,8
Pg 48	NPT 2"	36 - 39	83	18	68	-	68	2	823.651.9	78,4
Pg 48	NPT 2"	39 - 42	83	18	68	-	68	2	823.652.9	78,4
Pg 48	NPT 2"	42 - 45	83	18	68	-	68	2	823.653.9	78,4



# Adapter IECEx-ATEX, BAC-316, IP 66 / 68, stainless steel

For armoured cable, IECEx-ATEX certified and marked;

▲ RCN (type) (thread size) IECEx INE 10.0010X Ex d/e I Mb IIC Gb Ex tb IIIC Db

CE 0080 INERIS 06ATEX0014X I M2 / II 2 GD, IP 66 / IP 68



BAC-316, ISO, IECEx-ATEX, EMC, barrier adapter fitting, stainless steel AISI-316, EPDM and epoxy seal (-40 °C till +100 °C)

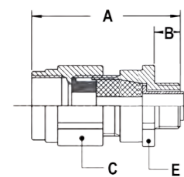

THREAD OUTER ISO	THREAD INNER NPT	CLAMPING RANGE (MM)	DIMENSIONS IN MM					STANDARD PACKAGE	ARTICLE NUMBER	WEIGHT (KG/100)
			A	B	C	D	E			
M20 x 1,5	NPT 1/2"	5,5 - 8	63	15	32	-	30	10	723.812.9	17,4
M20 x 1,5	NPT 1/2"	8 - 10,5	63	15	32	-	30	10	723.813.9	17,4
M20 x 1,5	NPT 1/2"	10,5 - 13	63	15	32	-	30	10	723.814.9	17,4
M25 x 1,5	NPT 3/4"	10,5 - 13	63	15	36	-	35	5	723.815.9	20,6
M25 x 1,5	NPT 3/4"	13 - 15,5	63	15	36	-	35	5	723.818.9	20,6
M25 x 1,5	NPT 3/4"	15,5 - 18	63	15	36	-	35	5	723.819.9	20,6
M32 x 1,5	NPT 1"	15 - 18	76	15	45	-	42	5	723.823.9	35,6
M32 x 1,5	NPT 1"	18 - 21	76	15	45	-	42	5	723.824.9	35,6
M32 x 1,5	NPT 1"	21 - 24	76	15	45	-	42	5	723.825.9	35,6
M40 x 1,5	NPT 1 1/4"	21 - 24	79	15	50	-	48	2	723.829.9	43,1
M40 x 1,5	NPT 1 1/4"	24 - 27	79	15	50	-	48	2	723.830.9	43,1
M40 x 1,5	NPT 1 1/4"	27 - 30	79	15	50	-	48	2	723.831.9	43,1
M50 x 1,5	NPT 1 1/2"	30 - 33	79	15	57	-	55	1	723.843.9	56,8
M50 x 1,5	NPT 1 1/2"	33 - 36	79	15	57	-	55	1	723.844.9	56,8
M63 x 1,5	NPT 2"	36 - 39	80	15	68	-	68	1	723.851.9	78,4
M63 x 1,5	NPT 2"	39 - 42	80	15	68	-	68	1	723.852.9	78,4
M63 x 1,5	NPT 2"	42 - 45	80	15	68	-	68	1	723.853.9	78,4

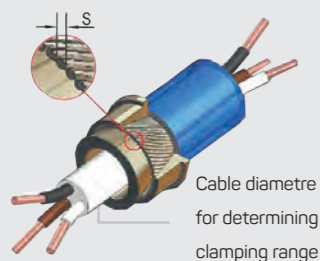

Cable diameter for determining clamping range

## Special information for EMC cable-hose fittings

1. In case of EMC versions, the cable diameter needed to determine the clamping range, is not the outer diameter of the cable but the diameter of the cable without the braiding.
2. In case of EMC versions with a wire diameter (S) from 1,0 till 2,5 mm (type SWA, Steel Wire Armour) a special version with reduced cone clamping rings must be ordered (article no. with suffix "-RC").

## ADAPTER IECEX-ATEX, BAC-316, IP 66 / 68, STAINLESS STEEL

For armoured cable, IECEX-ATEX certified and marked;

▲ RCN (type) (thread size) IECEX INE 10.0010X Ex d/e I Mb IIC Gb Ex tb IIIC Db  
 CE 0080 INERIS 06ATEX0014X I M2 / II 2 GD, IP 66 / IP 68

BAC-316, NPT, IECEX-ATEX, EMC, barrier adapter fitting, stainless steel  
 AISI-316, EPDM and epoxy seal (-40 °C till +100°C)

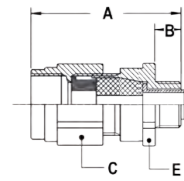

THREAD OUTER NPT	THREAD INNER NPT	CLAMPING RANGE (MM)	DIMENSIONS IN MM					STANDARD PACKAGE	ARTICLE NUMBER	WEIGHT (KG/100)
			A	B	C	D	E			
NPT 1/2"	NPT 1/2"	5,5 - 8	66	18	32	-	30	10	723.912.9	17,4
NPT 1/2"	NPT 1/2"	8 - 10,5	66	18	32	-	30	10	723.913.9	17,4
NPT 1/2"	NPT 1/2"	10,5 - 13	66	18	32	-	30	10	723.914.9	17,4
NPT 3/4"	NPT 3/4"	10,5 - 13	66	18	36	-	35	5	723.915.9	20,6
NPT 3/4"	NPT 3/4"	13 - 15,5	66	18	36	-	35	5	723.918.9	20,6
NPT 3/4"	NPT 3/4"	15,5 - 18	66	18	36	-	35	5	723.919.9	20,6
NPT 1"	NPT 1"	15 - 18	83	22	45	-	42	5	723.923.9	35,6
NPT 1"	NPT 1"	18 - 21	83	22	45	-	42	5	723.924.9	35,6
NPT 1"	NPT 1"	21 - 24	83	22	45	-	42	5	723.925.9	35,6
NPT 1.1/4"	NPT 1.1/4"	21 - 24	86	22	50	-	48	2	723.929.9	43,1
NPT 1.1/4"	NPT 1.1/4"	24 - 27	86	22	50	-	48	2	723.930.9	43,1
NPT 1.1/4"	NPT 1.1/4"	27 - 30	86	22	50	-	48	2	723.931.9	43,1
NPT 1.1/2"	NPT 1.1/2"	30 - 33	88	24	57	-	55	2	723.943.9	56,8
NPT 1.1/2"	NPT 1.1/2"	33 - 36	88	24	57	-	55	2	723.944.9	56,8
NPT 2"	NPT 2"	36 - 39	89	24	68	-	68	2	723.951.9	78,4
NPT 2"	NPT 2"	39 - 42	89	24	68	-	68	2	723.952.9	78,4
NPT 2"	NPT 2"	42 - 45	89	24	68	-	68	2	723.953.9	78,4
NPT 2.1/2"	NPT 2.1/2"	45 - 48	104	28	80	-	80	1	723.954.9	112,4
NPT 2.1/2"	NPT 2.1/2"	48 - 51	104	28	80	-	80	1	723.955.9	112,4
NPT 2.1/2"	NPT 2.1/2"	51 - 54	104	28	80	-	80	1	723.956.9	112,4
NPT 3"	NPT 3"	54 - 58	111	28	102	-	100	1	723.957.9	223,5
NPT 3"	NPT 3"	58 - 62	111	28	102	-	100	1	723.958.9	223,5

Atex fittings

BAC-316, Pg, IECEX-ATEX, EMC, barrier adapter fitting,  
 stainless steel AISI-316, EPDM and epoxy seal (-40 °C till +100°C)

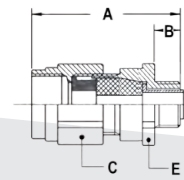

THREAD OUTER PG	THREAD INNER NPT	CLAMPING RANGE (MM)	DIMENSIONS IN MM					STANDARD PACKAGE	ARTICLE NUMBER	WEIGHT (KG/100)
			A	B	C	D	E			
Pg 11	NPT 1/2"	5,5 - 8	63	15	32	-	30	10	723.611.9	17,4
Pg 13,5	NPT 1/2"	5,5 - 8	63	15	32	-	30	10	723.612.9	17,4
Pg 13,5	NPT 1/2"	8 - 10,5	63	15	32	-	30	10	723.613.9	17,4
Pg 13,5	NPT 1/2"	10,5 - 13	63	15	32	-	30	10	723.614.9	17,4
Pg 16	NPT 3/4"	10,5 - 13	63	15	36	-	35	5	723.615.9	20,6
Pg 16	NPT 3/4"	13 - 15,5	63	15	36	-	35	5	723.618.9	20,6
Pg 16	NPT 3/4"	15,5 - 18	63	15	36	-	35	5	723.619.9	20,6
Pg 21	NPT 1"	15 - 18	76	15	45	-	42	5	723.623.9	35,6
Pg 21	NPT 1"	18 - 21	76	15	45	-	42	5	723.624.9	35,6
Pg 21	NPT 1"	21 - 24	76	15	45	-	42	5	723.625.9	35,6
Pg 29	NPT 1.1/4"	21 - 24	81	17	50	-	48	2	723.629.9	43,1
Pg 29	NPT 1.1/4"	24 - 27	81	17	50	-	48	2	723.630.9	43,1
Pg 29	NPT 1.1/4"	27 - 30	81	17	50	-	48	2	723.631.9	43,1
Pg 36	NPT 1.1/2"	30 - 33	81	17	57	-	55	2	723.643.9	56,8
Pg 36	NPT 1.1/2"	33 - 36	81	17	57	-	55	2	723.644.9	56,8
Pg 48	NPT 2"	36 - 39	83	18	68	-	68	2	723.651.9	78,4
Pg 48	NPT 2"	39 - 42	83	18	68	-	68	2	723.652.9	78,4
Pg 48	NPT 2"	42 - 45	83	18	68	-	68	2	723.653.9	78,4

# Cable-gland IECEx-ATEX, BXN, IP 66 / 68, nickel plated brass



## ANAMET IECEx-ATEX BARRIER CABLE-GLAND TYPE BXN, NICKEL PLATED BRASS

Type BXN IECEx-ATEX approved barrier cable-glands are designed to secure loose wires and unarmoured cables (stripped) in a potentially explosive atmosphere. The barrier is made by mixing a 2 component epoxy resin which is supplied standard with each cable-gland and allowing it to cure. The cable-gland is suitable for use as a connection between an Exd and Exe enclosure as well as on control equipment, terminal boxes, instruments and devices in the chemical and petrochemical-industry, oil and gas, food, pharma, bulk handling and wood processing industries.

### Material & Construction:

**Construction:** Nickel plated brass gland, consisting of 4 parts (backnut, pressure ring, barrier container and male body). Separately, a 2 component epoxy resin is supplied for creating the barrier.

**Material:** Backnut, pressure ring, barrier container and male body are nickel plated brass. Also available in stainless steel AISI-316.

Glands are fully RoHS compliant.

**Temperature:** -60 °C till +130 °C continuous.

**Protection class:** IP 66 between body and switchbox.

IP 68 can be obtained with a flat seal between body and switchbox.

**Colour:** Metal coloured.

For loose wires and unarmoured cables:

▲ RCN (type) (thread size) IECEx INE 10.0010X Ex d/e I Mb IIC Gb Ex tb IIIC Db  
 ⚡ CE 0080 INERIS 06ATEX0014X I M2 / II 2 GD, IP 66 / IP 68

BXN, ISO, Explosion proof IECEx-ATEX barrier cable-gland, nickel plated brass, epoxy barrier type (-60 °C till +130°C)

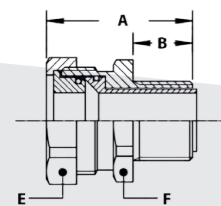

THREAD OUTSIDE	THREAD INSIDE	MIN. INTERNAL BORE (MM)	DIMENSIONS IN MM					STANDARD PACKAGE	ARTICLE NUMBER	WEIGHT (KG/100)
			A	B	C	E	F			
M16 x 1,5	-	10,4	39	15	-	26	25	10	836.216.0*	8,4
M20 x 1,5	-	13,8	40	15	-	30	28	10	836.220.0	10,6
M25 x 1,5	-	18,5	41	15	-	35	34	5	836.225.0	14,7
M32 x 1,5	-	24,4	41	15	-	45	43	5	836.232.0	24,3
M40 x 1,5	-	31,9	42	15	-	55	52	2	836.240.0	33,7
M50 x 1,5	-	37,9	43	15	-	57	55	2	836.250.0	37,9

\* Size M16 is not permitted for Group I (Mining) applications.

BXN, NPT, Explosion proof IECEx-ATEX barrier cable-gland, nickel plated brass, epoxy barrier type (-60 °C till +130°C)

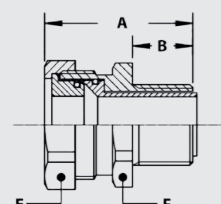

THREAD OUTSIDE	THREAD INSIDE	MIN. INTERNAL BORE (MM)	DIMENSIONS IN MM					STANDARD PACKAGE	ARTICLE NUMBER	WEIGHT (KG/100)
			A	B	C	E	F			
NPT 1/2"	-	13,8	45	20	-	30	28	10	837.216.0	11,5
NPT 3/4"	-	18,5	46	21	-	35	34	5	837.220.0	15,8
NPT 1"	-	24,4	51	25	-	45	43	5	837.226.0	28,4
NPT 1.1/4"	-	31,9	53	26	-	55	52	2	837.235.0	39,4
NPT 1.1/2"	-	37,9	54	26	-	57	55	2	837.240.0	45,8

# Cable-gland IECEx-ATEX, BXN-316, IP 66 / 68, stainless steel



## ANAMET IECEx-ATEX BARRIER CABLE-GLAND TYPE BXN-316, STAINLESS STEEL AISI-316

Type BXN-316 IECEx-ATEX approved barrier cable-glands are used to secure loose wires and unarmoured cables (stripped) in Exd and Exe applications. The barrier is made by mixing a 2 component epoxy resin supplied standard with the gland and allowing it to cure. The use of stainless steel materials ensures that the cable-gland resists corrosion and aggressive chemicals in harsh operating conditions. The cable-gland is suitable for use as a connection between an Exd and Exe enclosure as well as on control equipment, terminal boxes, instruments and devices in the chemical and petrochemical-industry, oil and gas, food, pharma, bulk handling and wood processing industries.

### Material & Construction:

**Construction:** Stainless steel gland, consisting of 4 parts (backnut, pressure ring, barrier container and male body).

Separately, a 2 component epoxy resin is supplied for creating the barrier.

**Material:** Backnut and male body are in stainless steel AISI-316, pressure ring and barrier container are nickel plated brass. Glands are fully

RoHS compliant.

**Temperature:** -60 °C till +130 °C continuous.

**Protection class:** IP 66 between body and switchbox.

IP 68 can be obtained with a flat seal between body and switchbox.

**Colour:** Metal coloured.

For loose wires and unarmoured cables (stripped), IECEx-ATEX certified and marked;  
 ▲ RCN (type) (thread size) IECEx CES 15.0001X Ex db / eb I Mb IIC Gb Ex tb IIIC Db  
 ⚙️ CE 0080 CESI 14ATEX069X I M2 / II 2 GD, IP 66 / IP 68

BXN-316, ISO, Explosion proof IECEx-ATEX barrier cable-gland, stainless steel AISI-316, epoxy barrier type (-60 °C till +130°C)



Atex fittings

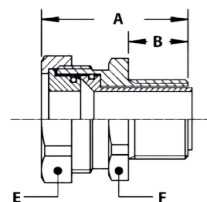

THREAD OUTSIDE	THREAD INSIDE	MIN. INTERNAL BORE (MM)	DIMENSIONS IN MM					STANDARD PACKAGE	ARTICLE NUMBER	WEIGHT (KG/100)
			A	B	C	E	F			
M16 x 1,5	-	10,4	39	15	-	26	25	10	836.216.9*	7,9
M20 x 1,5	-	13,8	40	15	-	30	28	10	836.220.9	10,1
M25 x 1,5	-	18,5	41	15	-	35	34	5	836.225.9	13,8
M32 x 1,5	-	24,4	41	15	-	45	43	5	836.232.9	22,9
M40 x 1,5	-	31,9	42	15	-	55	52	2	836.240.9	31,8
M50 x 1,5	-	37,9	43	15	-	57	55	2	836.250.9	35,8

\* Size M16 is not permitted for Group I (Mining) applications.

BXN-316, NPT, Explosion proof IECEx-ATEX barrier cable-gland, stainless steel AISI-316, epoxy barrier type (-60 °C till +130°C)

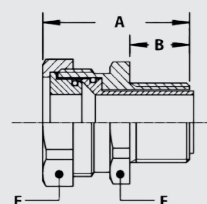

THREAD OUTSIDE	THREAD INSIDE	MIN. INTERNAL BORE (MM)	DIMENSIONS IN MM					STANDARD PACKAGE	ARTICLE NUMBER	WEIGHT (KG/100)
			A	B	C	E	F			
NPT 1/2"	-	13,8	45	20	-	30	28	10	837.216.9	10,8
NPT 3/4"	-	18,5	46	21	-	35	34	5	837.220.9	14,9
NPT 1"	-	24,4	51	25	-	45	43	5	837.226.9	26,8
NPT 1.1/4"	-	31,9	53	26	-	55	52	2	837.235.9	37,2
NPT 1.1/2"	-	37,9	54	26	-	57	55	2	837.240.9	43,3

# Cable-gland IECEx-ATEX, RN, IP 66 / 68, nickel plated brass

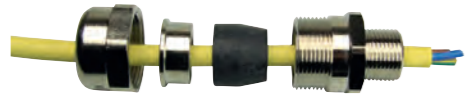

## ANAMET IECEx-ATEX CABLE-GLAND, TYPE RN, NICKEL PLATED BRASS

Type RN IECEx-ATEX approved nickel plated brass cable-glands are used for a single unarmoured cable. Typical applications include motors, transformers, control equipment, Ex enclosures, terminal boxes and components etc., in the chemical and petrochemical, oil and gas, wood processing, bulk handling and food and pharma industries.

### Material & Construction:

**Construction:** Nickel plated brass fitting, consisting of 4 parts (Backnut, pressure ring, sealing rubber, and male body).

**Material:** Backnut, pressure ring and male body are nickel plated brass. The sealing rubber is from EPDM. Also available in stainless steel AISI-316.

**Temperature:** -40 °C till +100 °C continuous. With silicone sealing rubber -65 °C till +220 °C continuous.

**Protection class:** Standard is IP 66, with a flat seal between body and switchbox IP 68.

**Colour:** Metal coloured.

For unarmoured cable, IECEx-ATEX certified and marked;

▲ RCN (type) (thread size) IECEx INE 10.0010X Ex d/e I Mb IIC Gb Ex tb IIIC Db  
 ⚡ CE 0080 INERIS 06ATEX0014X I M2 / II 2 GD, IP 66 / IP 68

RN, ISO, IECEx-ATEX, cable-gland, nickel plated brass, EPDM rubber seal (-40 °C till +100°C)

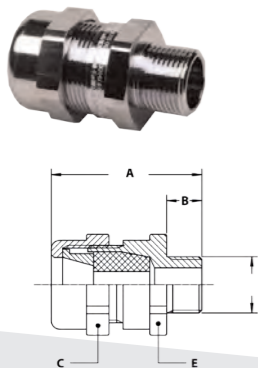

THREAD OUTER ISO	CLAMPING RANGE (MM)	DIMENSIONS IN MM					STANDARD PACKAGE	ARTICLE NUMBER	WEIGHT (KG/100)
		A	B	C	D	E			
M16 x 1,5	4 - 7	53	15	24	-	24	10	840.010.0	9,4
M16 x 1,5	7 - 10	53	15	24	-	24	10	840.011.0	9,4
M20 x 1,5	5,5 - 8	55	15	32	-	30	10	840.012.0	15,6
M20 x 1,5	8 - 10,5	55	15	32	-	30	10	840.013.0	15,6
M20 x 1,5	10,5 - 13	55	15	32	-	30	10	840.014.0	15,6
M25 x 1,5	10,5 - 13	55	15	36	-	35	10	840.015.0	18,5
M25 x 1,5	13 - 15,5	55	15	36	-	35	10	840.018.0	18,5
M25 x 1,5	15,5 - 18	55	15	36	-	35	10	840.019.0	18,5
M32 x 1,5	15 - 18	67	15	45	-	42	10	840.023.0	34
M32 x 1,5	18 - 21	67	15	45	-	42	10	840.024.0	34
M32 x 1,5	21 - 24	67	15	45	-	42	10	840.025.0	34
M40 x 1,5	21 - 24	67	15	50	-	48	10	840.029.0	42,1
M40 x 1,5	24 - 27	67	15	50	-	48	10	840.030.0	42,1
M40 x 1,5	27 - 30	67	15	50	-	48	10	840.031.0	42,1
M50 x 1,5	30 - 33	67	15	57	-	55	5	840.043.0	53,7
M50 x 1,5	33 - 36	67	15	57	-	55	5	840.044.0	53,7
M63 x 1,5	36 - 39	67	15	68	-	68	5	840.051.0	74,9
M63 x 1,5	39 - 42	67	15	68	-	68	5	840.052.0	74,9
M63 x 1,5	42 - 45	67	15	68	-	68	5	840.053.0	74,9
M75 x 1,5	45 - 48	67	15	80	-	80	5	840.054.0	108,5
M75 x 1,5	48 - 51	67	15	80	-	80	5	840.055.0	108,5
M90 x 2,0	54 - 58	87	20	100	-	100	5	840.057.0	212,5
M90 x 2,0	58 - 62	87	20	100	-	100	5	840.058.0	212,5

## CABLE-GLAND IECEX-ATEX, RN, IP 66 / 68, NICKEL PLATED BRASS

For unarmoured cable, IECEX-ATEX certified and marked;

▲ RCN (type) (thread size) IECEX INE 10.0010X Ex d/e I Mb IIC Gb Ex tb IIIC Db

CE 0080 INERIS 06ATEX0014X I M2 / II 2 GD, IP 66 / IP 68

RN, NPT, IECEX-ATEX, cable-gland, nickel plated brass,  
EPDM rubber seal (-40 °C till +100°C)

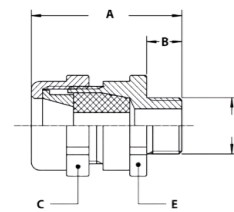

THREAD OUTER NPT	CLAMPING RANGE (MM)	DIMENSIONS IN MM					STANDARD PACKAGE	ARTICLE NUMBER	WEIGHT (KG/100)
		A	B	C	D	E			
NPT 1/2"	5,5 - 8	58	18	32	-	30	10	841.012.0	15,6
NPT 1/2"	8 - 10,5	58	18	32	-	30	10	841.013.0	15,6
NPT 1/2"	10,5 - 13	58	18	32	-	30	10	841.014.0	15,6
NPT 3/4"	10,5 - 13	58	18	36	-	35	10	841.015.0	18,5
NPT 3/4"	13 - 15,5	58	18	36	-	35	10	841.018.0	18,5
NPT 3/4"	15,5 - 18	58	18	36	-	35	10	841.019.0	18,5
NPT 1"	15 - 18	74	22	45	-	42	10	841.023.0	34
NPT 1"	18 - 21	74	22	45	-	42	10	841.024.0	34
NPT 1"	21 - 24	74	22	45	-	42	10	841.025.0	34
NPT 1 1/4"	21 - 24	74	22	50	-	48	10	841.029.0	42,1
NPT 1 1/4"	24 - 27	74	22	50	-	48	10	841.030.0	42,1
NPT 1 1/4"	27 - 30	74	22	50	-	48	10	841.031.0	42,1
NPT 1 1/2"	30 - 33	76	24	57	-	55	5	841.043.0	53,7
NPT 1 1/2"	33 - 36	76	24	57	-	55	5	841.044.0	53,7
NPT 2"	36 - 39	76	24	68	-	68	5	841.051.0	74,9
NPT 2"	39 - 42	76	24	68	-	68	5	841.052.0	74,9
NPT 2"	42 - 45	76	24	68	-	68	5	841.053.0	74,9
NPT 2 1/2"	45 - 48	80	28	80	-	80	5	841.054.0	108,5
NPT 2 1/2"	48 - 51	80	28	80	-	80	5	841.055.0	108,5
NPT 3"	54 - 58	95	28	100	-	100	5	841.057.0	212,5
NPT 3"	58 - 62	95	28	100	-	100	5	841.058.0	212,5

Atex fittings



# Cable-gland IECEx-ATEX, RN-316, IP 66 / 68, stainless steel



## ANAMET IECEx-ATEX CABLE-GLAND, TYPE RN-316, STAINLESS STEEL AISI-316

Type RN-316 IECEx-ATEX approved stainless steel AISI-316 cable-glands, are used for a single unarmoured cable. Typical applications include motors, transformers, control equipment, Ex enclosures, terminal boxes and components etc., in the chemical and petrochemical, oil and gas, wood processing, bulk handling and food and pharma industries.

### Material & Construction:

**Construction:** Stainless steel fitting, consisting of 4 parts (backnut, pressure ring, sealing rubber, and male body).

**Material:** Backnut, and male body are stainless steel AISI-316. The pressure ring is made from nickel plated brass. The sealing rubber is from EPDM. Also available in nickel plated brass.

**Temperature:** -40 °C till +100 °C continuous. With silicone sealing rubber -65 °C till +220 °C continuous.

**Protection class:** Standard is IP 66, with a flat seal between body and switchbox IP 68.

**Colour:** Metal coloured.

For unarmoured cable, IECEx-ATEX certified and marked;

▲ RCN (type) (thread size) IECEx INE 10.0010X Ex d/e I Mb IIC Gb Ex tb IIIC Db

⚡ CE 0080 INERIS 06ATEX0014X I M2 / II 2 GD, IP 66 / IP 68

RN-316, ISO, IECEx-ATEX, cable-gland, stainless steel AISI-316, EPDM rubber seal (-40 °C till +100°C)

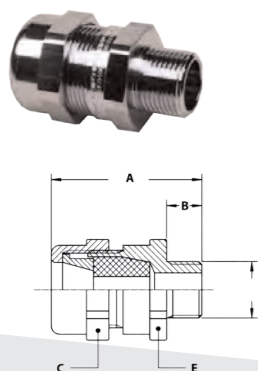

THREAD OUTER ISO	CLAMPING RANGE (MM)	DIMENSIONS IN MM					STANDARD PACKAGE	ARTICLE NUMBER	WEIGHT (KG/100)
		A	B	C	D	E			
M16 x 1,5	4 - 7	53	15	24	-	24	10	840.010.9	9,4
M16 x 1,5	7 - 10	53	15	24	-	24	10	840.011.9	9,4
M20 x 1,5	5,5 - 8	55	15	32	-	30	10	840.012.9	15,6
M20 x 1,5	8 - 10,5	55	15	32	-	30	10	840.013.9	15,6
M20 x 1,5	10,5 - 13	55	15	32	-	30	10	840.014.9	15,6
M25 x 1,5	10,5 - 13	55	15	36	-	35	10	840.015.9	18,5
M25 x 1,5	13 - 15,5	55	15	36	-	35	10	840.018.9	18,5
M25 x 1,5	15,5 - 18	55	15	36	-	35	10	840.019.9	18,5
M32 x 1,5	15 - 18	67	15	45	-	42	10	840.023.9	34
M32 x 1,5	18 - 21	67	15	45	-	42	10	840.024.9	34
M32 x 1,5	21 - 24	67	15	45	-	42	10	840.025.9	34
M40 x 1,5	21 - 24	67	15	50	-	48	10	840.029.9	42,1
M40 x 1,5	24 - 27	67	15	50	-	48	10	840.030.9	42,1
M40 x 1,5	27 - 30	67	15	50	-	48	10	840.031.9	42,1
M50 x 1,5	30 - 33	67	15	57	-	55	5	840.043.9	53,7
M50 x 1,5	33 - 36	67	15	57	-	55	5	840.044.9	53,7
M63 x 1,5	36 - 39	67	15	68	-	68	5	840.051.9	74,9
M63 x 1,5	39 - 42	67	15	68	-	68	5	840.052.9	74,9
M63 x 1,5	42 - 45	67	15	68	-	68	5	840.053.9	74,9
M75 x 1,5	45 - 48	67	15	80	-	80	5	840.054.9	108,5
M75 x 1,5	48 - 51	67	15	80	-	80	5	840.055.9	108,5
M90 x 2,0	54 - 58	87	20	100	-	100	5	840.057.9	212,5
M90 x 2,0	58 - 62	87	20	100	-	100	5	840.058.9	212,5

## CABLE-GLAND IECEX-ATEX, RN-316, IP 66 / 68, STAINLESS STEEL

For unarmoured cable, IECEX-ATEX certified and marked;

▲ RCN (type) (thread size) IECEX INE 10.0010X Ex d/e I Mb IIC Gb Ex tb IIIC Db

CE 0080 INERIS 06ATEX0014X I M2 / II 2 GD, IP 66 / IP 68

RN-316, NPT, IECEX-ATEX, cable-gland, stainless steel AISI-316,  
EPDM rubber seal (-40 °C till +100°C)

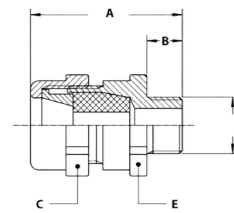

THREAD OUTER NPT	CLAMPING RANGE (MM)	DIMENSIONS IN MM					STANDARD PACKAGE	ARTICLE NUMBER	WEIGHT (KG/100)
		A	B	C	D	E			
NPT 1/2"	5,5 - 8	58	18	32	-	30	10	841.012.9	15,6
NPT 1/2"	8 - 10,5	58	18	32	-	30	10	841.013.9	15,6
NPT 1/2"	10,5 - 13	58	18	32	-	30	10	841.014.9	15,6
NPT 3/4"	10,5 - 13	58	18	36	-	35	10	841.015.9	18,5
NPT 3/4"	13 - 15,5	58	18	36	-	35	10	841.018.9	18,5
NPT 3/4"	15,5 - 18	58	18	36	-	35	10	841.019.9	18,5
NPT 1"	15 - 18	74	22	45	-	42	10	841.023.9	34
NPT 1"	18 - 21	74	22	45	-	42	10	841.024.9	34
NPT 1"	21 - 24	74	22	45	-	42	10	841.025.9	34
NPT 1 1/4"	21 - 24	74	22	50	-	48	10	841.029.9	42,1
NPT 1 1/4"	24 - 27	74	22	50	-	48	10	841.030.9	42,1
NPT 1 1/4"	27 - 30	74	22	50	-	48	10	841.031.9	42,1
NPT 1 1/2"	30 - 33	76	24	57	-	55	5	841.043.9	53,7
NPT 1 1/2"	33 - 36	76	24	57	-	55	5	841.044.9	53,7
NPT 2"	36 - 39	76	24	68	-	68	5	841.051.9	74,9
NPT 2"	39 - 42	76	24	68	-	68	5	841.051.9	74,9
NPT 2"	42 - 45	76	24	68	-	68	5	841.051.9	74,9
NPT 2 1/2"	45 - 48	80	28	80	-	80	5	841.054.9	108,5
NPT 2 1/2"	48 - 51	80	28	80	-	80	5	841.055.9	108,5
NPT 3"	54 - 58	95	28	100	-	100	5	841.057.9	212,5
NPT 3"	58 - 62	95	28	100	-	100	5	841.058.9	212,5

Atex fittings

# Double seal cable-gland IECEx-ATEX, RAD, IP 66 / 68, nickel plated brass



## ANAMET IECEx-ATEX DOUBLE SEAL CABLE-GLAND, TYPE RAD, NICKEL PLATED BRASS

Type RAD IECEx-ATEX approved nickel plated brass cable-gland with double seal, is used for general purposes for an armoured cable. Anamet IECEx-ATEX approved cable-glands type RAD are the most common types in the oil and gas industry. This solid cable-gland is suitable for all European applications in potentially explosive atmospheres. They are frequently used in the off-shore, chemical and petrochemical industry. The explosionproof cable-glands are available in ISO and NPT threads.

### Material & Construction:

**Construction:** Nickel plated brass cable gland, consisting of 8 parts (back nut, anti-friction ring, sealing rubber outer cable, intermediate body, double pressure ring, sealing rubber inner cable and male body).

**Material:** Back nut, anti-friction ring, intermediate body, double pressure ring and male body are nickel plated brass, sealing rubbers are from EPDM rubber. Also available in stainless steel AISI-316.

**Temperature:** -40 °C till +100 °C continuous. With silicone sealing rubber -65 °C till +220 °C continuous.

**Protection class:** Standard is IP 66, with a flat seal between body and switchbox IP 68.

**Colour:** Metal coloured.

For unarmoured cable, IECEx-ATEX certified and marked;

▲ RCN (type) (thread size) IECEx INE 10.0010X Ex d/e I Mb IIC Gb Ex tb IIIC Db

⚡ CE 0080 INERIS 06ATEX0014X I M2 / II 2 GD, IP 66 / IP 68

RAD, ISO, IECEx-ATEX, EMC cable-gland, nickel plated brass, EPDM rubber seal (-40 °C till +100°C)

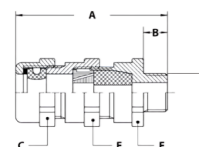

THREAD OUTER ISO	CLAMPING RANGE (MM)		DIMENSIONS IN MM					STANDARD PACKAGE	ARTICLE NUMBER	WEIGHT (KG/100)
	Outer cable	Inner cable	A	B	C	E	F			
M16 x 1,5	5 - 10	4 - 7	73	15	24	24	24	10	721.810.0	12,6
M16 x 1,5	10 - 15	7 - 10	73	15	24	24	24	10	721.811.0	12,6
M20 x 1,5	10 - 15	5,5 - 8	79	15	32	32	30	10	721.812.0	12,8
M20 x 1,5	14 - 19	8 - 10,5	79	15	32	32	30	10	721.813.0	12,8
M20 x 1,5	14 - 19	10,5 - 13	79	15	32	32	30	10	721.814.0	12,8
M25 x 1,5	15 - 20	10,5 - 13	79	15	36	36	35	10	721.815.0	26,4
M25 x 1,5	19 - 24	13 - 15,5	79	15	36	36	35	10	721.818.0	26,4
M25 x 1,5	19 - 24	15,5 - 18	79	15	36	36	35	10	721.819.0	26,4
M32 x 1,5	20 - 26	15 - 18	98	15	45	45	42	10	721.823.0	48,4
M32 x 1,5	25 - 31	18 - 21	98	15	45	45	42	10	721.824.0	48,4
M32 x 1,5	25 - 31	21 - 24	98	15	45	45	42	10	721.825.0	48,4
M40 x 1,5	26 - 32	21 - 24	98	15	50	50	48	10	721.829.0	57,6
M40 x 1,5	26 - 32	24 - 27	98	15	50	50	48	10	721.830.0	57,6
M40 x 1,5	31 - 37	27 - 30	98	15	50	50	48	10	721.831.0	57,6
M40 x 1,5	31 - 37	30 - 33	98	15	50	50	48	10	721.832.0	73
M50 x 1,5	31 - 37	30 - 33	98	15	57	57	55	5	721.843.0	73
M50 x 1,5	36 - 43	33 - 36	98	15	57	57	55	5	721.844.0	73
M63 x 1,5	42 - 48	36 - 39	98	15	68	68	68	5	721.851.0	96,1
M63 x 1,5	47 - 53	39 - 42	98	15	68	68	68	5	721.852.0	96,1
M63 x 1,5	47 - 53	42 - 45	98	15	68	68	68	5	721.853.0	96,1
M75 x 1,5	52 - 64	48 - 51	98	15	80	80	80	5	721.855.0	139,2

## CABLE-GLAND IECEX-ATEX, RAD, IP 66 / 68, NICKEL PLATED BRASS

For armoured cable, IECEX-ATEX certified and marked;

▲ RCN (type) (thread size) IECEX INE 10.0010X Ex d/e I Mb IIC Gb Ex tb IIIC Db

CE 0080 INERIS 06ATEX0014X I M2 / II 2 GD, IP 66 / IP 68

RAD, NPT, Explosion proof ATEX EMC cable-gland,  
nickel plated brass, EPDM rubber seal (-40 °C till +100°C)

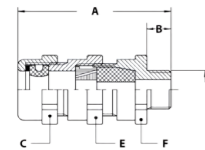

THREAD OUTER NPT	CLAMPING RANGE (MM)		DIMENSIONS IN MM					STANDARD PACKAGE	ARTICLE NUMBER	WEIGHT (KG/100)
	Outer cable	Inner cable	A	B	C	E	F			
NPT 1/2"	10 - 15	5,5 - 8	82	18	32	32	30	10	721.912.0	12,8
NPT 1/2"	14 - 19	8 - 10,5	82	18	32	32	30	10	721.913.0	12,8
NPT 1/2"	14 - 19	10,5 - 13	82	18	32	32	30	10	721.914.0	12,8
NPT 3/4"	15 - 20	10,5 - 13	82	18	36	36	35	10	721.915.0	26,4
NPT 3/4"	19 - 24	13 - 15,5	82	18	36	36	35	10	721.918.0	26,4
NPT 3/4"	19 - 24	15,5 - 18	82	18	36	36	35	10	721.919.0	26,4
NPT 1"	20 - 26	15 - 18	105	22	45	45	42	10	721.923.0	48,4
NPT 1"	25 - 31	18 - 21	105	22	45	45	42	10	721.924.0	48,4
NPT 1"	25 - 31	21 - 24	105	22	45	45	42	10	721.925.0	48,4
NPT 1.1/4"	26 - 32	21 - 24	105	22	50	50	48	10	721.929.0	57,6
NPT 1.1/4"	31 - 37	24 - 27	105	22	50	50	48	10	721.930.0	57,6
NPT 1.1/4"	31 - 37	27 - 30	105	22	50	50	48	10	721.931.0	57,6
NPT 1.1/2"	31 - 37	30 - 33	107	24	57	57	55	5	721.943.0	73
NPT 1.1/2"	36 - 43	33 - 36	107	24	57	57	55	5	721.944.0	73
NPT 2"	42 - 48	36 - 39	107	24	68	68	68	5	721.951.0	96,1

Atex fittings

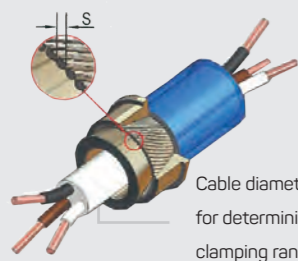

Cable diameter for determining clamping range

### Special information for EMC cable-glands

1. In case of EMC versions, the cable diameter needed to determine both the clamping range of the inner and outer diameter of the cable (inner cable diameter is the cable without the braiding).
2. In case of the wire diameter (S) from 1,0 till 2,5 mm (type SWA, Steel Wire Armour) a special version with reduced cone clamping rings must be ordered (article no. with suffix "-RC").

# Double seal cable-gland IECEx-ATEX, RAD-316, IP 66 / 68, stainless steel



## ANAMET IECEx-ATEX DOUBLE SEAL CABLE-GLAND, TYPE RAD-316, STAINLESS STEEL AISI-316

Type RAD-316 IECEx-ATEX approved stainless steel AISI-316 cable gland, with double seal, is used for general purposes for an armoured cable. Anamet IECEx-ATEX approved cable glands type RAD-316 are the most common types in the oil and gas industry. This solid cable gland is suitable for all European applications in potentially explosive atmospheres. They are frequently used in the off-shore, chemical and petrochemical industry. The explosion proof cable glands are available in ISO and NPT threads.

### Material & Construction:

**Construction:** Nickel plated brass cable gland, consisting of 8 parts (back nut, anti-friction ring, sealing rubber outer cable, intermediate body, double pressure ring, sealing rubber inner cable and male body).

**Material:** Back nut, intermediate body and male body are stainless steel AISI-316. Anti-friction ring, double pressure ring are made from nickel plated brass. Sealing rubbers are from EPDM.

**Temperature:** -40 °C till +100 °C continuous. With silicone sealing rubber -65 °C till +220 °C continuous.

**Protection class:** Standard is IP 66, with a flat seal between body and switchbox IP 68.

**Colour:** Metal coloured.

For armoured cable, IECEx-ATEX certified and marked;

▲ RCN (type) (thread size) IECEx INE 10.0010X Ex d/e I Mb IIC Gb Ex tb IIIC Db

☑ CE 0080 INERIS 06ATEX0014X I M2 / II 2 GD, IP 66 / IP 68

RAD-316, ISO, Explosion proof ATEX EMC cable-gland, stainless steel AISI-316, EPDM rubber seal (-40 °C till +100°C)

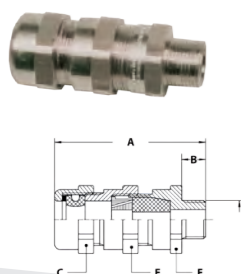

THREAD OUTER ISO	CLAMPING RANGE (MM)		DIMENSIONS IN MM				STANDARD PACKAGE	ARTICLE NUMBER	WEIGHT (KG/100)	
	Outer cable	Inner cable	A	B	C	E				F
M16 x 1,5	5 - 10	4 - 7	73	15	24	24	24	10	721.810.9	12,6
M16 x 1,5	10 - 15	7 - 10	73	15	24	24	24	10	721.811.9	12,6
M20 x 1,5	10 - 15	5,5 - 8	79	15	32	32	30	10	721.812.9	12,8
M20 x 1,5	14 - 19	8 - 10,5	79	15	32	32	30	10	721.813.9	12,8
M20 x 1,5	14 - 19	10,5 - 13	79	15	32	32	30	10	721.814.9	12,8
M25 x 1,5	15 - 20	10,5 - 13	79	15	36	36	35	10	721.815.9	26,4
M25 x 1,5	19 - 24	13 - 15,5	79	15	36	36	35	10	721.818.9	26,4
M25 x 1,5	19 - 24	15,5 - 18	79	15	36	36	35	10	721.819.9	26,4
M32 x 1,5	20 - 26	15 - 18	98	15	45	45	42	10	721.823.9	48,4
M32 x 1,5	25 - 31	18 - 21	98	15	45	45	42	10	721.824.9	48,4
M32 x 1,5	25 - 31	21 - 24	98	15	45	45	42	10	721.825.9	48,4
M40 x 1,5	26 - 32	21 - 24	98	15	50	50	48	10	721.829.9	57,6
M40 x 1,5	26 - 32	24 - 27	98	15	50	50	48	10	721.830.9	57,6
M40 x 1,5	31 - 37	27 - 30	98	15	50	50	48	10	721.831.9	57,6
M40 x 1,5	31 - 37	30 - 33	98	15	50	50	48	10	721.832.9	73
M50 x 1,5	31 - 37	30 - 33	98	15	57	57	55	5	721.843.9	73
M50 x 1,5	36 - 43	33 - 36	98	15	57	57	55	5	721.844.9	73
M63 x 1,5	42 - 48	36 - 39	98	15	68	68	68	5	721.851.9	96,1
M63 x 1,5	47 - 53	39 - 42	98	15	68	68	68	5	721.852.9	96,1
M63 x 1,5	47 - 53	42 - 45	98	15	68	68	68	5	721.853.9	96,1
M75 x 1,5	52 - 64	48 - 51	98	15	80	80	80	5	721.855.9	139,2

## CABLE-GLAND IECEX-ATEX, RAD-316, IP 66 / 68, STAINLESS STEEL

For armoured cable, IECEX-ATEX certified and marked;

▲ RCN (type) (thread size) IECEX INE 10.0010X Ex d/e I Mb IIC Gb Ex tb IIIC Db

CE 0080 INERIS 06ATEX0014X I M2 / II 2 GD, IP 66 / IP 68

RAD-316, NPT, Explosion proof ATEX EMC cable-gland,  
stainless steel AISI-316, EPDM rubber seal (-40 °C till +100°C)

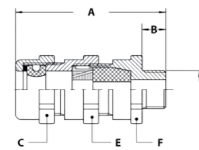

THREAD OUTER NPT	CLAMPING RANGE (MM)		DIMENSIONS IN MM					STANDARD PACKAGE	ARTICLE NUMBER	WEIGHT (KG/100)
	Outer cable	Inner cable	A	B	C	E	F			
NPT 1/2"	10 - 15	5,5 - 8	82	18	32	32	30	10	721.912.9	12,8
NPT 1/2"	14 - 19	8 - 10,5	82	18	32	32	30	10	721.913.9	12,8
NPT 1/2"	14 - 19	10,5 - 13	82	18	32	32	30	10	721.914.9	12,8
NPT 3/4"	15 - 20	10,5 - 13	82	18	36	36	35	10	721.915.9	26,4
NPT 3/4"	19 - 24	13 - 15,5	82	18	36	36	35	10	721.918.9	26,4
NPT 3/4"	19 - 24	15,5 - 18	82	18	36	36	35	10	721.919.9	26,4
NPT 1"	20 - 26	15 - 18	105	22	45	45	42	10	721.923.9	48,4
NPT 1"	25 - 31	18 - 21	105	22	45	45	42	10	721.924.9	48,4
NPT 1"	25 - 31	21 - 24	105	22	45	45	42	10	721.925.9	48,4
NPT 1.1/4"	26 - 32	21 - 24	105	22	50	50	48	10	721.929.9	57,6
NPT 1.1/4"	31 - 37	24 - 27	105	22	50	50	48	10	721.930.9	57,6
NPT 1.1/4"	31 - 37	27 - 30	105	22	50	50	48	10	721.931.9	57,6
NPT 1.1/2"	31 - 37	30 - 33	107	24	57	57	55	5	721.943.9	73
NPT 1.1/2"	36 - 43	33 - 36	107	24	57	57	55	5	721.944.9	73
NPT 2"	42 - 48	36 - 39	107	24	68	68	68	5	721.951.9	96,1

Atex fittings

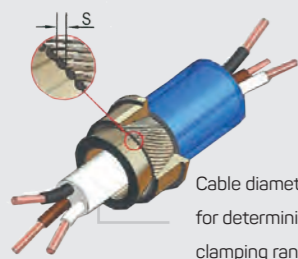

Cable diameter for determining clamping range

### Special information for EMC cable-glands

1. In case of EMC versions, the cable diameter needed to determine both the clamping range of the inner and outer diameter of the cable (inner cable diameter is the cable without the braiding).
2. In case of the wire diameter (S) from 1,0 till 2,5 mm (type SWA, Steel Wire Armour) a special version with reduced cone clamping rings must be ordered (article no. with suffix "-RC").



## ANACONDA IECEX-ATEX, ACCESSORIES, NICKEL PLATED BRASS



ISO lock nuts, nickel plated brass



THREAD	SEALTITE SIZE (INCH)	MIN. INTERNAL BORE (MM)	DIMENSIONS IN MM					STANDARD PACKAGE	ARTICLE NUMBER	WEIGHT (KG/100)
			A	B	C	D	E			
M16 x 1,5	-	-	3	-	20	-	-	50	880.116.0	0,4
M20 x 1,5	-	-	3,5	-	24	-	-	50	880.120.0	0,6
M25 x 1,5	-	-	3,5	-	30	-	-	25	880.125.0	0,9
M32 x 1,5	-	-	4,5	-	35	-	-	20	880.132.0	2,2
M40 x 1,5	-	-	4,5	-	45	-	-	10	880.140.0	3,2
M50 x 1,5	-	-	5,5	-	55	-	-	10	880.150.0	5
M63 x 1,5	-	-	6	-	70	-	-	5	880.163.0	5,6
M75 x 1,5	-	-	7	-	80	-	-	5	880.175.0	-
M90 x 2,0	-	-	8	-	100	-	-	5	880.190.0	-

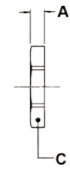

Pg lock nuts, nickel plated brass



THREAD	SEALTITE SIZE (INCH)	MIN. INTERNAL BORE (MM)	DIMENSIONS IN MM					STANDARD PACKAGE	ARTICLE NUMBER	WEIGHT (KG/100)
			A	B	C	D	E			
Pg 7	-	-	2,9	-	15	-	-	50	880.007.0	0,2
Pg 9	-	-	2,9	-	18	-	-	50	880.009.0	0,2
Pg 11	-	-	2,9	-	21	-	-	50	880.011.0	0,3
Pg 13,5	-	-	3,1	-	23	-	-	50	880.013.0	0,4
Pg 16	-	-	3,1	-	26	-	-	50	880.016.0	0,5
Pg 21	-	-	3,6	-	32	-	-	20	880.021.0	0,8
Pg 29	-	-	4,1	-	41	-	-	20	880.029.0	1,4
Pg 36	-	-	5,1	-	51	-	-	10	880.036.0	2,1
Pg 42	-	-	5,1	-	60	-	-	5	880.042.0	3,6
Pg 48	-	-	5,6	-	64	-	-	5	880.048.0	4,1



NPT lock nuts, nickel plated brass



THREAD	SEALTITE SIZE (INCH)	MIN. INTERNAL BORE (MM)	DIMENSIONS IN MM					STANDARD PACKAGE	ARTICLE NUMBER	WEIGHT (KG/100)
			A	B	C	D	E			
NPT 1/2"	-	-	4	-	27	-	-	50	880.216.0	1,1
NPT 3/4"	-	-	4,5	-	32	-	-	25	880.220.0	1,4
NPT 1"	-	-	6	-	38	-	-	25	880.226.0	2,1
NPT 1.1/4"	-	-	6,5	-	48	-	-	5	880.235.0	3,5
NPT 1.1/2"	-	-	7	-	55	-	-	5	880.240.0	5
NPT 2"	-	-	7,5	-	70	-	-	5	880.250.0	8,8

ANACONDA IECEX-ATEX, ACCESSORIES, NICKEL PLATED BRASS



Neoprene sealing gasket for ISO



THREAD ISO	THREAD PG	THREAD NPT	DIMENSIONS IN MM					STANDARD PACKAGE	ARTICLE NUMBER	WEIGHT (KG/100)
			A	B	C	D	E			
M16 x 1,5	-	-	1,2	-	20	14	-	100	815.416.0	0,03
M20 x 1,5	-	-	1,2	-	24	18	-	100	815.420.0	0,03
M25 x 1,5	-	-	1,2	-	30	23	-	50	815.425.0	0,05
M32 x 1,5	-	-	1,2	-	40	30	-	50	815.432.0	0,11
M40 x 1,5	-	-	1,2	-	48	38	-	50	815.440.0	0,15
M50 x 1,5	-	-	1,2	-	58	48	-	50	815.450.0	0,19
M63 x 1,5	-	-	1,2	-	75	61	-	50	815.463.0	0,33



Neoprene sealing gasket for Pg / NPT



THREAD ISO	THREAD PG	THREAD NPT	DIMENSIONS IN MM					STANDARD PACKAGE	ARTICLE NUMBER	WEIGHT (KG/100)
			A	B	C	D	E			
-	Pg 7	-	1,2	-	17	11,5	-	100	815.507.0	0,03
-	Pg 9	-	1,2	-	20	14	-	100	815.509.0	0,03
-	Pg 11	-	1,2	-	23	17	-	100	815.511.0	0,03
-	Pg 13,5	-	1,2	-	25	19	-	100	815.513.0	0,04
-	Pg 16	NPT 1/2"	1,2	-	27	21	-	100	815.516.0	0,05
-	Pg 21	NPT 3/4"	1,2	-	34	26,5	-	50	815.521.0	0,07
-	Pg 29	NPT 1"	1,2	-	45	35	-	50	815.529.0	0,13
-	Pg 36	NPT 1.1/4"	1,2	-	56	45	-	50	815.536.0	0,19
-	Pg 42	NPT 1.1/2"	1,2	-	67	52	-	50	815.542.0	0,3
-	Pg 48	NPT 2"	1,2	-	72	58	-	50	815.548.0	0,34

Atex fittings



NBR sealing gasket for NPT



THREAD	SEALTITE SIZE (INCH)	MIN. INTERNAL BORE (MM)	DIMENSIONS IN MM					STANDARD PACKAGE	ARTICLE NUMBER	WEIGHT (KG/100)
			A	B	C	D	E			
NPT 1/2"	1/2"	-	-	-	-	-	-	50	815.616.0	0,03
NPT 3/4"	3/4"	-	-	-	-	-	-	25	815.620.0	0,05
NPT 1"	1"	-	-	-	-	-	-	25	815.626.0	0,11
NPT 1.1/4"	1.1/4"	-	-	-	-	-	-	10	815.635.0	0,15
NPT 1.1/2"	1.1/2"	-	-	-	-	-	-	10	815.640.0	0,19
NPT 2"	2"	-	-	-	-	-	-	10	815.650.0	0,33
NPT 2.1/2"	2.1/2"	-	-	-	-	-	-	10	815.663.0	0,45
NPT 3"	3"	-	-	-	-	-	-	10	815.675.0	0,6

## ANACONDA IECEX-ATEX, ACCESSORIES, NICKEL PLATED BRASS

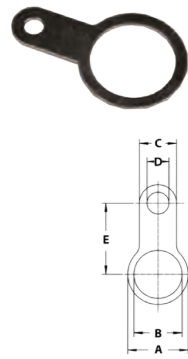

Earth tags, nickel plated brass for ISO / Pg / NPT



THREAD ISO	THREAD PG	THREAD NPT	DIMENSIONS IN MM					STANDARD PACKAGE	ARTICLE NUMBER	WEIGHT (KG/100)
			A	B	C	D	E			
M16 x 1,5	-	NPT 3/8"	30	18	12	6,5	30	50	880.510.0	-
-	Pg 11	-	30	20	12	6,5	30	50	880.511.0	-
M20 x 1,5	Pg 13,5	NPT 1/2"	30	22	12	6,5	30	50	880.512.0	-
M25 x 1,5	-	NPT 3/4"	36	28	15	6,5	35	50	880.513.0	-
-	Pg 16	-	36	24	15	6,5	35	50	880.516.0	-
M32 x 1,5	-	NPT 1"	52	34	18	9	50	50	880.520.0	-
-	Pg 21	-	52	30	18	9	50	50	880.521.0	-
-	-	NPT 1.1/4"	52	43	18	9	50	50	880.525.0	-
M40 x 1,5	-	-	52	42	18	9	50	50	880.527.0	-
-	Pg 29	-	52	38	18	9	50	50	880.529.0	-
-	-	NPT 1.1/2"	62	50	22	11	60	50	880.532.0	-
M50 x 1,5	-	-	62	52	22	11	60	50	880.535.0	-
-	Pg 36	-	62	49	22	11	60	50	880.536.0	-
-	Pg 42	-	75	56	22	11	70	50	880.542.0	-
-	Pg 48	NPT 2"	75	61	22	11	70	50	880.548.0	-
M63 x 1,5	-	-	75	65	22	11	70	50	880.550.0	-

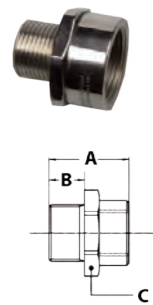

ISO / ISO enlarger, nickel plated brass



OUTSIDE THREAD	INSIDE THREAD	MIN. INTERNAL BORE (MM)	DIMENSIONS IN MM					STANDARD PACKAGE	ARTICLE NUMBER	WEIGHT (KG/100)
			A	B	C	D	E			
M16 x 1,5	M20 x 1,5	-	33	15	26	-	-	10	781.220.0	-
M20 x 1,5	M25 x 1,5	-	33	15	32	-	-	10	781.225.0	-
M25 x 1,5	M32 x 1,5	-	33	15	40	-	-	5	781.232.0	-
M32 x 1,5	M40 x 1,5	-	33	15	45	-	-	2	781.240.0	-
M40 x 1,5	M50 x 1,5	-	33	15	55	-	-	1	781.250.0	-
M50 x 1,5	M63 x 1,5	-	33	15	70	-	-	1	781.263.0	-

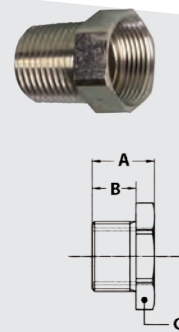

ISO / ISO reducer, nickel plated brass



OUTSIDE THREAD	INSIDE THREAD	MIN. INTERNAL BORE (MM)	DIMENSIONS IN MM					STANDARD PACKAGE	ARTICLE NUMBER	WEIGHT (KG/100)
			A	B	C	D	E			
M20 x 1,5	M16 x 1,5	-	26	15	24	-	-	10	782.216.0	-
M25 x 1,5	M20 x 1,5	-	26	15	30	-	-	10	782.220.0	-
M32 x 1,5	M25 x 1,5	-	26	15	36	-	-	5	782.225.0	-
M40 x 1,5	M32 x 1,5	-	26	15	45	-	-	2	782.232.0	-
M50 x 1,5	M40 x 1,5	-	29	15	55	-	-	1	782.240.0	-
M63 x 1,5	M50 x 1,5	-	29	15	70	-	-	1	782.250.0	-

## ANACONDA IECEX-ATEX, ACCESSORIES, NICKEL PLATED BRASS

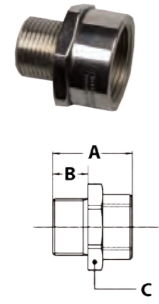

ISO / Pg adapter, nickel plated brass



OUTSIDE THREAD	INSIDE THREAD	MIN. INTERNAL BORE (MM)	DIMENSIONS IN MM					STANDARD PACKAGE	ARTICLE NUMBER	WEIGHT (KG/100)
			A	B	C	D	E			
M20 x 1,5	Pg 11	-	33	15	24	-	-	10	781.111.0	-
M25 x 1,5	Pg 16	-	33	15	30	-	-	10	781.116.0	-
M25 x 1,5	Pg 21	-	33	15	36	-	-	5	781.118.0	-
M32 x 1,5	Pg 21	-	33	15	36	-	-	5	781.121.0	-
M40 x 1,5	Pg 29	-	33	15	45	-	-	2	781.129.0	-
M50 x 1,5	Pg 36	-	33	15	55	-	-	1	781.136.0	-
M63 x 1,5	Pg 48	-	38	15	70	-	-	1	781.148.0	-

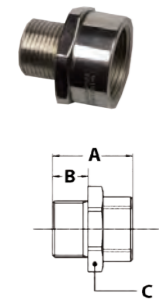

Pg / ISO adapter, nickel plated brass



OUTSIDE THREAD	INSIDE THREAD	MIN. INTERNAL BORE (MM)	DIMENSIONS IN MM					STANDARD PACKAGE	ARTICLE NUMBER	WEIGHT (KG/100)
			A	B	C	D	E			
Pg 11	M16 x 1,5	-	33	15	24	-	-	10	782.111.0	-
Pg 16	M20 x 1,5	-	33	15	26	-	-	10	782.116.0	-
Pg 21	M25 x 1,5	-	33	15	32	-	-	5	782.121.0	-
Pg 29	M32 x 1,5	-	26	15	40	-	-	2	782.129.0*	-
Pg 36	M40 x 1,5	-	29	15	50	-	-	1	782.136.0*	-

\* Shape different from photo and drawing (reducer shape)

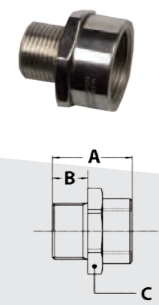

ISO / NPT adapter, nickel plated brass



OUTSIDE THREAD	INSIDE THREAD	MIN. INTERNAL BORE (MM)	DIMENSIONS IN MM					STANDARD PACKAGE	ARTICLE NUMBER	WEIGHT (KG/100)
			A	B	C	D	E			
M16 x 1,5	NPT 1/2"	-	36	15	26	-	-	10	782.612.0	-
M20 x 1,5	NPT 1/2"	-	36	15	26	-	-	10	782.616.0	-
M25 x 1,5	NPT 1/2"	-	26	15	30	-	-	5	782.618.0*	-
M25 x 1,5	NPT 3/4"	-	36	15	32	-	-	5	782.620.0	-
M32 x 1,5	NPT 1"	-	40	15	40	-	-	5	782.626.0	-
M40 x 1,5	NPT 1.1/4"	-	40	15	50	-	-	2	782.635.0	-
M50 x 1,5	NPT 1.1/2"	-	42	15	55	-	-	1	782.640.0	-
M63 x 1,5	NPT 2"	-	42	15	70	-	-	1	782.650.0	-

\* Shape different from photo and drawing (reducer shape)

Atex fittings

ANACONDA IECEX-ATEX, ACCESSORIES, NICKEL PLATED BRASS

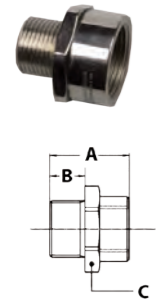

Pg / NPT adapter, nickel plated brass



OUTSIDE THREAD	INSIDE THREAD	MIN. INTERNAL BORE (MM)	DIMENSIONS IN MM					STANDARD PACKAGE	ARTICLE NUMBER	WEIGHT (KG/100)
			A	B	C	D	E			
Pg 11	NPT 3/8"	-	33	15	24	-	-	10	782.411.0	-
Pg 11	NPT 1/2"	-	36	15	26	-	-	10	782.412.0	-
Pg 13,5	NPT 1/2"	-	36	15	26	-	-	10	782.413.0	-
Pg 16	NPT 1/2"	-	36	15	26	-	-	10	782.416.0	-
Pg 21	NPT 3/4"	-	36	15	32	-	-	5	782.420.0	-
Pg 29	NPT 1"	-	40	15	40	-	-	5	782.426.0	-
Pg 29	NPT 1.1/4"	-	40	15	50	-	-	2	782.435.0	-
Pg 36	NPT 1.1/2"	-	42	15	55	-	-	1	782.440.0	-
Pg 48	NPT 2"	-	47	20	70	-	-	1	782.450.0	-

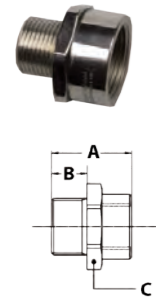

NPT / Pg adapter, nickel plated brass



OUTSIDE THREAD	INSIDE THREAD	MIN. INTERNAL BORE (MM)	DIMENSIONS IN MM					STANDARD PACKAGE	ARTICLE NUMBER	WEIGHT (KG/100)
			A	B	C	D	E			
NPT 1/2"	Pg 11	-	36	18	24	-	-	10	782.311.0	-
NPT 1/2"	Pg 13,5	-	36	18	26	-	-	10	782.313.0	-
NPT 1/2"	Pg 16	-	36	18	27	-	-	10	782.316.0	-
NPT 3/4"	Pg 16	-	36	18	27	-	-	5	782.320.0	-
NPT 3/4"	Pg 21	-	36	18	36	-	-	5	782.321.0	-
NPT 1"	Pg 21	-	40	22	36	-	-	5	782.326.0	-
NPT 1"	Pg 29	-	40	22	45	-	-	5	782.329.0	-
NPT 1.1/4"	Pg 29	-	40	22	45	-	-	2	782.330.0	-
NPT 1.1/4"	Pg 36	-	40	22	55	-	-	1	782.336.0	-
NPT 1.1/2"	Pg 36	-	42	24	55	-	-	1	782.340.0	-
NPT 1.1/2"	Pg 42	-	47	24	60	-	-	1	782.342.0	-
NPT 2"	Pg 48	-	47	24	65	-	-	1	782.348.0	-

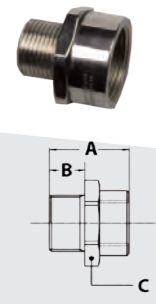

NPT / ISO adapter, nickel plated brass



OUTSIDE THREAD	INSIDE THREAD	MIN. INTERNAL BORE (MM)	DIMENSIONS IN MM					STANDARD PACKAGE	ARTICLE NUMBER	WEIGHT (KG/100)
			A	B	C	D	E			
NPT 1/2"	M16 x 1,5	-	29	18	24	-	-	10	782.516.0*	-
NPT 1/2"	M20 x 1,5	-	36	18	26	-	-	10	782.520.0	-
NPT 1/2"	M25 x 1,5	-	36	18	32	-	-	10	782.522.0	-
NPT 3/4"	M20 x 1,5	-	29	18	27	-	-	5	782.524.0*	-
NPT 3/4"	M25 x 1,5	-	36	18	32	-	-	5	782.525.0	-
NPT 3/4"	M32 x 1,5	-	36	18	40	-	-	5	782.527.0	-
NPT 1"	M25 x 1,5	-	33	22	36	-	-	5	782.528.0*	-
NPT 1"	M32 x 1,5	-	40	22	40	-	-	5	782.532.0	-
NPT 1"	M40 x 1,5	-	40	22	45	-	-	2	782.534.0	-
NPT 1.1/4"	M32 x 1,5	-	33	22	45	-	-	2	782.538.0*	-
NPT 1.1/4"	M40 x 1,5	-	40	22	45	-	-	2	782.540.0	-
NPT 1.1/2"	M40 x 1,5	-	38	24	50	-	-	1	782.548.0*	-
NPT 1.1/2"	M50 x 1,5	-	42	24	55	-	-	1	782.550.0	-
NPT 1.1/2"	M63 x 1,5	-	42	24	70	-	-	1	782.552.0	-
NPT 2"	M50 x 1,5	-	38	24	65	-	-	1	782.560.0*	-
NPT 2"	M63 x 1,5	-	42	24	70	-	-	1	782.563.0	-

\* Shape different from photo and drawing (reducer shape)

## ANACONDA IECEX-ATEX, ACCESSORIES, NICKEL PLATED BRASS

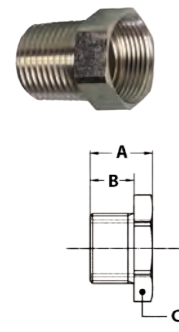

NPT / NPT reducer, nickel plated brass



OUTSIDE THREAD	INSIDE THREAD	MIN. INTERNAL BORE (MM)	DIMENSIONS IN MM					STANDARD PACKAGE	ARTICLE NUMBER	WEIGHT (KG/100)
			A	B	C	D	E			
NPT 1/2"	NPT 3/8"	-	36	18	24	-	-	10	782.816.0	-
NPT 3/4"	NPT 1/2"	-	29	18	27	-	-	5	782.820.0	-
NPT 1"	NPT 1/2"	-	33	22	36	-	-	5	782.822.0	-
NPT 1"	NPT 3/4"	-	33	22	36	-	-	5	782.825.0	-
NPT 1.1/4"	NPT 3/4"	-	33	22	45	-	-	2	782.828.0	-
NPT 1.1/4"	NPT 1"	-	33	22	45	-	-	2	782.835.0	-
NPT 1.1/2"	NPT 3/4"	-	38	24	50	-	-	1	782.836.0	-
NPT 1.1/2"	NPT 1"	-	38	24	50	-	-	1	782.838.0	-
NPT 1.1/2"	NPT 1.1/4"	-	38	24	50	-	-	1	782.840.0	-
NPT 2"	NPT 1.1/4"	-	38	24	65	-	-	1	782.845.0	-
NPT 2"	NPT 1.1/2"	-	38	24	70	-	-	1	782.850.0	-

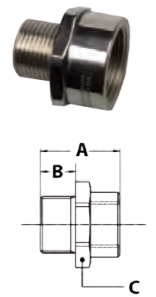

NPT / NPT enlarger, nickel plated brass



OUTSIDE THREAD	INSIDE THREAD	MIN. INTERNAL BORE (MM)	DIMENSIONS IN MM					STANDARD PACKAGE	ARTICLE NUMBER	WEIGHT (KG/100)
			A	B	C	D	E			
NPT 1/2"	NPT 3/4"	-	39	18	32	-	-	10	781.816.0	-
NPT 1/2"	NPT 1"	-	43	18	40	-	-	10	781.818.0	-
NPT 3/4"	NPT 1"	-	43	18	40	-	-	5	781.820.0	-
NPT 3/4"	NPT 1.1/4"	-	43	18	50	-	-	5	781.822.0	-
NPT 1"	NPT 1.1/4"	-	47	22	55	-	-	5	781.826.0	-
NPT 1"	NPT 1.1/2"	-	49	22	55	-	-	5	781.828.0	-
NPT 1.1/4"	NPT 1.1/2"	-	49	22	55	-	-	2	781.835.0	-
NPT 1.1/4"	NPT 2"	-	49	22	70	-	-	2	781.838.0	-
NPT 1.1/2"	NPT 2"	-	51	24	70	-	-	1	781.840.0	-

Atex fittings



NPT / NPT coupling, female / female, nickel plated brass



INSIDE THREAD	INSIDE THREAD	MIN. INTERNAL BORE (MM)	DIMENSIONS IN MM					STANDARD PACKAGE	ARTICLE NUMBER	WEIGHT (KG/100)
			A	B	C	D	E			
NPT 1/2"	NPT 1/2"	-	-	-	-	-	-	10	782.716.0	-
NPT 3/4"	NPT 3/4"	-	-	-	-	-	-	10	782.720.0	-
NPT 1"	NPT 1"	-	-	-	-	-	-	5	782.726.0	-
NPT 1.1/4"	NPT 1.1/4"	-	-	-	-	-	-	2	782.735.0	-
NPT 1.1/2"	NPT 1.1/2"	-	-	-	-	-	-	1	782.740.0	-
NPT 2"	NPT 2"	-	-	-	-	-	-	1	782.750.0	-



## ANACONDA IECEX-ATEX, ACCESSORIES, NICKEL PLATED BRASS



NPT / NPT nipple, male / male, nickel plated brass



OUTSIDE THREAD	OUTSIDE THREAD	MIN. INTERNAL BORE (MM)	DIMENSIONS IN MM					STANDARD PACKAGE	ARTICLE NUMBER	WEIGHT (KG/100)
			A	B	C	D	E			
NPT 1/2"	NPT 1/2"	-	-	-	-	-	-	10	781.716.0	-
NPT 3/4"	NPT 3/4"	-	-	-	-	-	-	5	781.720.0	-
NPT 1"	NPT 1"	-	-	-	-	-	-	5	781.726.0	-
NPT 1.1/4"	NPT 1.1/4"	-	-	-	-	-	-	2	781.735.0	-
NPT 1.1/2"	NPT 1.1/2"	-	-	-	-	-	-	1	781.740.0	-
NPT 2"	NPT 2"	-	-	-	-	-	-	1	781.750.0	-



Blind plug, nickel plated brass, ISO



OUTSIDE THREAD	INSIDE THREAD	MIN. INTERNAL BORE (MM)	DIMENSIONS IN MM					STANDARD PACKAGE	ARTICLE NUMBER	WEIGHT (KG/100)
			A	B	C	D	E			
M16 x 1,5	-	-	20	15	20	-	-	10	781.316.0	-
M20 x 1,5	-	-	20	15	24	-	-	10	781.320.0	-
M25 x 1,5	-	-	20	15	30	-	-	5	781.325.0	-
M32 x 1,5	-	-	20	15	36	-	-	5	781.332.0	-
M40 x 1,5	-	-	20	15	45	-	-	2	781.340.0	-
M50 x 1,5	-	-	23	15	55	-	-	1	781.350.0	-
M63 x 1,5	-	-	23	15	68	-	-	1	781.363.0	-
M75 x 1,5	-	-	28	20	80	-	-	1	781.375.0	-

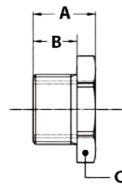

Blind plugs, nickel plated brass, NPT



OUTSIDE THREAD	INSIDE THREAD	MIN. INTERNAL BORE (MM)	DIMENSIONS IN MM					STANDARD PACKAGE	ARTICLE NUMBER	WEIGHT (KG/100)
			A	B	C	D	E			
NPT 1/2"	-	-	23	18	24	-	-	10	781.416.0	-
NPT 3/4"	-	-	23	18	27	-	-	5	781.420.0	-
NPT 1"	-	-	27	22	36	-	-	5	781.426.0	-
NPT 1.1/4"	-	-	27	22	45	-	-	2	781.435.0	-
NPT 1.1/2"	-	-	32	24	50	-	-	1	781.440.0	-
NPT 2"	-	-	32	24	68	-	-	1	781.450.0	-

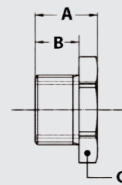

## ANACONDA IECEX-ATEX, ACCESSORIES, NICKEL PLATED BRASS

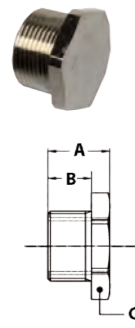

Blind plugs, nickel plated brass, Pg



OUTSIDE THREAD	INSIDE THREAD	MIN. INTERNAL BORE (MM)	DIMENSIONS IN MM					STANDARD PACKAGE	ARTICLE NUMBER	WEIGHT (KG/100)
			A	B	C	D	E			
Pg 11	-	-	20	15	24	-	-	10	781.511.0	-
Pg 13,5	-	-	20	15	26	-	-	10	781.513.0	-
Pg 16	-	-	20	15	26	-	-	10	781.516.0	-
Pg 21	-	-	20	15	32	-	-	5	781.521.0	-
Pg 29	-	-	20	15	40	-	-	5	781.529.0	-
Pg 36	-	-	23	15	50	-	-	2	781.536.0	-
Pg 42	-	-	28	20	60	-	-	1	781.542.0	-
Pg 48	-	-	28	20	68	-	-	1	781.548.0	-

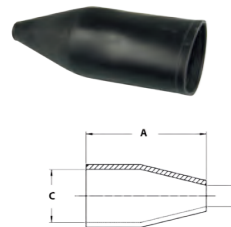

Shrouds, EPDM, for cable glands\*



THREAD ISO	THREAD PG	THREAD NPT	DIMENSIONS IN MM					STANDARD PACKAGE	ARTICLE NUMBER	WEIGHT (KG/100)
			A	B	C	D	E			
M16 x 1,5	Pg 11	-	84	-	23	-	6	10	782.916.0	-
M20 x 1,5	Pg 13,5	NPT 1/2"	103	-	31	-	8	10	782.920.0	-
M25 x 1,5	Pg 16	NPT 3/4"	103	-	35	-	12	5	782.925.0	-
M32 x 1,5	Pg 21	NPT 1"	109	-	44	-	18	5	782.932.0	-
M40 x 1,5	Pg 29	NPT 1.1/4"	109	-	51	-	25	2	782.940.0	-
M50 x 1,5	Pg 36	NPT 1.1/2"	113	-	59	-	30	1	782.950.0	-
M63 x 1,5	Pg 42	NPT 2"	113	-	69	-	40	1	782.963.0	-
M75 x 1,5	Pg 48	NPT 2.1/2"	118	-	83	-	52	1	782.975.0	-

\* For use with cable-hose fittings the size E should be enlarged to fit the conduit diameter.

Atex fittings

## ANACONDA IECEX-ATEX, ACCESSORIES, STAINLESS STEEL



ISO locknut, stainless steel AISI-316



THREAD	SEALTITE SIZE (INCH)	MIN. INTERNAL BORE (MM)	DIMENSIONS IN MM					STANDARD PACKAGE	ARTICLE NUMBER	WEIGHT (KG/100)
			A	B	C	D	E			
M16 x 1,5	-	-	3,2	-	20	-	-	50	880.116.8	0,5
M20 x 1,5	-	-	3,6	-	24	-	-	50	880.120.8	0,7
M25 x 1,5	-	-	3,6	-	29	-	-	25	880.125.8	1,1
M32 x 1,5	-	-	4,6	-	35	-	-	25	880.132.8	2,4
M40 x 1,5	-	-	5	-	46	-	-	5	880.140.8	3,6
M50 x 1,5	-	-	5	-	60	-	-	5	880.150.8	5,4
M63 x 1,5	-	-	6	-	70	-	-	5	880.163.8	6,2

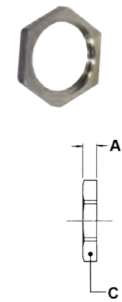

NPT locknut, stainless steel AISI-316



THREAD	SEALTITE SIZE (INCH)	MIN. INTERNAL BORE (MM)	DIMENSIONS IN MM					STANDARD PACKAGE	ARTICLE NUMBER	WEIGHT (KG/100)
			A	B	C	D	E			
NPT 1/2"	-	-	4	-	27	-	-	50	880.216.8	1,1
NPT 3/4"	-	-	4,5	-	32	-	-	25	880.220.8	1,4
NPT 1"	-	-	6	-	38	-	-	25	880.226.8	2,1
NPT 1.1/4"	-	-	6,5	-	48	-	-	5	880.235.8	3,5
NPT 1.1/2"	-	-	7	-	55	-	-	5	880.240.8	5
NPT 2"	-	-	7,5	-	70	-	-	5	880.250.8	8,8



Neoprene flat sealing gasket for ISO



THREAD ISO	THREAD PG	THREAD NPT	DIMENSIONS IN MM					STANDARD PACKAGE	ARTICLE NUMBER	WEIGHT (KG/100)
			A	B	C	D	E			
M16 x 1,5	-	-	1,2	-	20	14	-	100	815.416.0	0,03
M20 x 1,5	-	-	1,2	-	24	18	-	100	815.420.0	0,03
M25 x 1,5	-	-	1,2	-	30	23	-	50	815.425.0	0,05
M32 x 1,5	-	-	1,2	-	40	30	-	50	815.432.0	0,11
M40 x 1,5	-	-	1,2	-	48	38	-	50	815.440.0	0,15
M50 x 1,5	-	-	1,2	-	58	48	-	50	815.450.0	0,19
M63 x 1,5	-	-	1,2	-	75	61	-	50	815.463.0	0,33

\*Note: on request also flat seals in silicone are available.



Neoprene flat sealing gasket for Pg / NPT



THREAD ISO	THREAD PG	THREAD NPT	DIMENSIONS IN MM					STANDARD PACKAGE	ARTICLE NUMBER	WEIGHT (KG/100)
			A	B	C	D	E			
-	Pg 7	-	1,2	-	17	11,5	-	100	815.507.0	0,03
-	Pg 9	-	1,2	-	20	14	-	100	815.509.0	0,03
-	Pg 11	-	1,2	-	23	17	-	100	815.511.0	0,03
-	Pg 13,5	-	1,2	-	25	19	-	100	815.513.0	0,04
-	Pg 16	NPT 1/2"	1,2	-	27	21	-	100	815.516.0	0,05
-	Pg 21	NPT 3/4"	1,2	-	34	26,5	-	50	815.521.0	0,07
-	Pg 29	NPT 1"	1,2	-	45	35	-	50	815.529.0	0,13
-	Pg 36	NPT 1.1/4"	1,2	-	56	45	-	50	815.536.0	0,19
-	Pg 42	NPT 1.1/2"	1,2	-	67	52	-	50	815.542.0	0,3
-	Pg 48	NPT 2"	1,2	-	72	58	-	50	815.548.0	0,34

\*Note: on request also flat seals in silicone are available.

ANACONDA IECEX-ATEX, ACCESSORIES, NICKEL PLATED BRASS

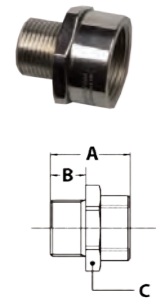

ISO / ISO enlarger, stainless steel AISI-316



OUTSIDE THREAD	INSIDE THREAD	MIN. INTERNAL BORE (MM)	DIMENSIONS IN MM					STANDARD PACKAGE	ARTICLE NUMBER	WEIGHT (KG/100)
			A	B	C	D	E			
M16 x 1,5	M20 x 1,5	-	33	15	26	-	-	10	781.220.8	-
M20 x 1,5	M25 x 1,5	-	33	15	32	-	-	10	781.225.8	-
M25 x 1,5	M32 x 1,5	-	33	15	40	-	-	5	781.232.8	-
M32 x 1,5	M40 x 1,5	-	33	15	45	-	-	2	781.240.8	-
M40 x 1,5	M50 x 1,5	-	33	15	55	-	-	1	781.250.8	-
M50 x 1,5	M63 x 1,5	-	33	15	70	-	-	1	781.263.8	-

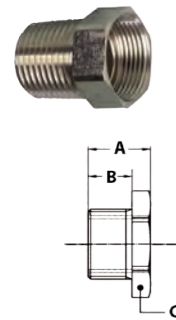

ISO / ISO reducer, stainless steel AISI-316



OUTSIDE THREAD	INSIDE THREAD	MIN. INTERNAL BORE (MM)	DIMENSIONS IN MM					STANDARD PACKAGE	ARTICLE NUMBER	WEIGHT (KG/100)
			A	B	C	D	E			
M20 x 1,5	M16 x 1,5	-	26	15	24	-	-	10	782.216.8	-
M25 x 1,5	M20 x 1,5	-	26	15	30	-	-	10	782.220.8	-
M32 x 1,5	M25 x 1,5	-	26	15	36	-	-	5	782.225.8	-
M40 x 1,5	M32 x 1,5	-	26	15	45	-	-	2	782.232.8	-
M50 x 1,5	M40 x 1,5	-	29	15	55	-	-	1	782.240.8	-
M63 x 1,5	M50 x 1,5	-	29	15	70	-	-	1	782.250.8	-

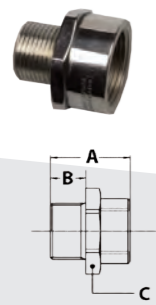

ISO / Pg adapter, stainless steel AISI-316



OUTSIDE THREAD	INSIDE THREAD	MIN. INTERNAL BORE (MM)	DIMENSIONS IN MM					STANDARD PACKAGE	ARTICLE NUMBER	WEIGHT (KG/100)
			A	B	C	D	E			
M20 x 1,5	Pg 11	-	33	15	24	-	-	10	781.111.8	-
M25 x 1,5	Pg 16	-	33	15	30	-	-	10	781.116.8	-
M25 x 1,5	Pg 21	-	33	15	36	-	-	5	781.118.8	-
M32 x 1,5	Pg 21	-	33	15	36	-	-	5	781.121.8	-
M40 x 1,5	Pg 29	-	33	15	45	-	-	2	781.129.8	-
M50 x 1,5	Pg 36	-	33	15	55	-	-	1	781.136.8	-
M63 x 1,5	Pg 48	-	38	15	70	-	-	1	781.148.8	-

Atex fittings

## ANACONDA IECEX-ATEX, ACCESSORIES, STAINLESS STEEL

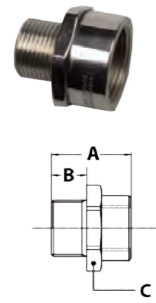

Pg / ISO adapter, stainless steel AISI-316



OUTSIDE THREAD	INSIDE THREAD	MIN. INTERNAL BORE (MM)	DIMENSIONS IN MM					STANDARD PACKAGE	ARTICLE NUMBER	WEIGHT (KG/100)
			A	B	C	D	E			
Pg 11	M16 x 1,5	-	33	15	24	-	-	10	782.111.8	-
Pg 16	M20 x 1,5	-	33	15	26	-	-	10	782.116.8	-
Pg 21	M25 x 1,5	-	33	15	32	-	-	5	782.121.8	-
Pg 29	M32 x 1,5	-	26	15	40	-	-	2	782.129.8*	-
Pg 36	M40 x 1,5	-	29	15	50	-	-	1	782.136.8*	-

\* Shape different from photo and drawing (reducer shape)

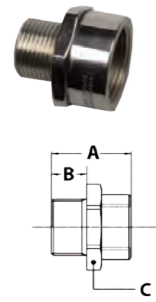

ISO / NPT adapter, stainless steel AISI-316



OUTSIDE THREAD	INSIDE THREAD	MIN. INTERNAL BORE (MM)	DIMENSIONS IN MM					STANDARD PACKAGE	ARTICLE NUMBER	WEIGHT (KG/100)
			A	B	C	D	E			
M16 x 1,5	NPT 1/2"	-	36	15	26	-	-	10	782.612.8	-
M20 x 1,5	NPT 1/2"	-	36	15	26	-	-	10	782.616.8	-
M25 x 1,5	NPT 1/2"	-	26	15	30	-	-	5	782.618.8*	-
M25 x 1,5	NPT 3/4"	-	36	15	32	-	-	5	782.620.8	-
M32 x 1,5	NPT 1"	-	40	15	40	-	-	5	782.626.8	-
M40 x 1,5	NPT 1.1/4"	-	40	15	50	-	-	2	782.635.8	-
M50 x 1,5	NPT 1.1/2"	-	42	15	55	-	-	1	782.640.8	-
M63 x 1,5	NPT 2"	-	42	15	70	-	-	1	782.650.8	-

\* Shape different from photo and drawing (reducer shape)

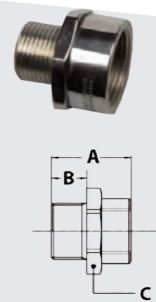

Pg / NPT adapter, stainless steel AISI-316



OUTSIDE THREAD	INSIDE THREAD	MIN. INTERNAL BORE (MM)	DIMENSIONS IN MM					STANDARD PACKAGE	ARTICLE NUMBER	WEIGHT (KG/100)
			A	B	C	D	E			
Pg 11	NPT 3/8"	-	33	15	24	-	-	10	782.411.8	-
Pg 11	NPT 1/2"	-	36	15	26	-	-	10	782.412.8	-
Pg 13,5	NPT 1/2"	-	36	15	26	-	-	10	782.413.8	-
Pg 16	NPT 1/2"	-	36	15	26	-	-	10	782.416.8	-
Pg 21	NPT 3/4"	-	36	15	32	-	-	5	782.420.8	-
Pg 29	NPT 1"	-	40	15	40	-	-	5	782.426.8	-
Pg 29	NPT 1.1/4"	-	40	15	50	-	-	2	782.435.8	-
Pg 36	NPT 1.1/2"	-	42	15	55	-	-	1	782.440.8	-
Pg 48	NPT 2"	-	47	20	70	-	-	1	782.450.8	-

## ANACONDA IECEX-ATEX, ACCESSORIES, STAINLESS STEEL

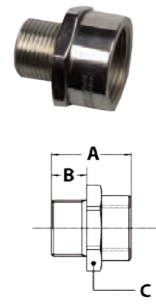

NPT / Pg adapter, stainless steel AISI-316



OUTSIDE THREAD	INSIDE THREAD	MIN. INTERNAL BORE (MM)	DIMENSIONS IN MM					STANDARD PACKAGE	ARTICLE NUMBER	WEIGHT (KG/100)
			A	B	C	D	E			
NPT 1/2"	Pg 11	-	36	18	24	-	-	10	782.311.8	-
NPT 1/2"	Pg 13,5	-	36	18	26	-	-	10	782.313.8	-
NPT 1/2"	Pg 16	-	36	18	27	-	-	10	782.316.8	-
NPT 3/4"	Pg 16	-	36	18	27	-	-	5	782.320.8	-
NPT 3/4"	Pg 21	-	36	18	36	-	-	5	782.321.8	-
NPT 1"	Pg 21	-	40	22	36	-	-	5	782.326.8	-
NPT 1"	Pg 29	-	40	22	45	-	-	5	782.329.8	-
NPT 1.1/4"	Pg 29	-	40	22	45	-	-	2	782.330.8	-
NPT 1.1/4"	Pg 36	-	40	24	55	-	-	1	782.336.8	-
NPT 1.1/2"	Pg 36	-	42	24	55	-	-	1	782.340.8	-
NPT 1.1/2"	Pg 42	-	47	24	60	-	-	1	782.342.8	-
NPT 2"	Pg 48	-	47	24	65	-	-	1	782.348.8	-

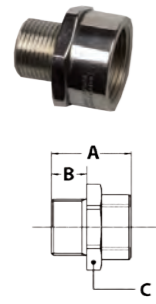

NPT / ISO adapter, stainless steel AISI-316



OUTSIDE THREAD	INSIDE THREAD	MIN. INTERNAL BORE (MM)	DIMENSIONS IN MM					STANDARD PACKAGE	ARTICLE NUMBER	WEIGHT (KG/100)
			A	B	C	D	E			
NPT 1/2"	M16 x 1,5	-	29	18	24	-	-	10	782.516.8*	-
NPT 1/2"	M20 x 1,5	-	36	18	26	-	-	10	782.520.8	-
NPT 1/2"	M25 x 1,5	-	36	18	32	-	-	10	782.522.8	-
NPT 3/4"	M20 x 1,5	-	29	18	27	-	-	5	782.524.8*	-
NPT 3/4"	M25 x 1,5	-	36	18	32	-	-	5	782.525.8	-
NPT 3/4"	M32 x 1,5	-	36	18	40	-	-	5	782.527.8	-
NPT 1"	M25 x 1,5	-	33	22	36	-	-	5	782.528.8*	-
NPT 1"	M32 x 1,5	-	40	22	40	-	-	5	782.532.8	-
NPT 1"	M40 x 1,5	-	40	22	45	-	-	2	782.534.8	-
NPT 1.1/4"	M32 x 1,5	-	33	22	45	-	-	2	782.538.8*	-
NPT 1.1/4"	M40 x 1,5	-	40	22	45	-	-	2	782.540.8	-
NPT 1.1/2"	M40 x 1,5	-	38	24	50	-	-	1	782.548.8*	-
NPT 1.1/2"	M50 x 1,5	-	42	24	55	-	-	1	782.550.8	-
NPT 1.1/2"	M63 x 1,5	-	42	24	70	-	-	1	782.552.8	-
NPT 2"	M50 x 1,5	-	38	24	65	-	-	1	782.560.8*	-
NPT 2"	M63 x 1,5	-	42	24	70	-	-	1	782.563.8	-

\* Shape different from photo and drawing (reducer shape)

Atex fittings



ANACONDA IECEX-ATEX, ACCESSORIES, STAINLESS STEEL

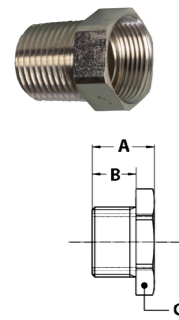

NPT / NPT reducer, stainless steel AISI-316



OUTSIDE THREAD	INSIDE THREAD	MIN. INTERNAL BORE (MM)	DIMENSIONS IN MM					STANDARD PACKAGE	ARTICLE NUMBER	WEIGHT (KG/100)
			A	B	C	D	E			
NPT 1/2"	NPT 3/8"	-	36	18	32	-	-	10	782.816.8	-
NPT 3/4"	NPT 1/2"	-	29	18	27	-	-	5	782.820.8	-
NPT 1"	NPT 1/2"	-	33	22	36	-	-	5	782.822.8	-
NPT 1"	NPT 3/4"	-	40	22	40	-	-	5	782.825.8	-
NPT 1.1/4"	NPT 3/4"	-	33	22	45	-	-	2	782.828.8	-
NPT 1.1/4"	NPT 1"	-	40	22	45	-	-	2	782.835.8	-
NPT 1.1/2"	NPT 3/4"	-	38	24	50	-	-	1	782.836.8	-
NPT 1.1/2"	NPT 1"	-	42	24	55	-	-	1	782.838.8	-
NPT 1.1/2"	NPT 1.1/4"	-	42	24	70	-	-	1	782.840.8	-
NPT 2"	NPT 1.1/4"	-	38	24	65	-	-	1	782.845.8	-
NPT 2"	NPT 1.1/2"	-	42	24	70	-	-	1	782.850.8	-

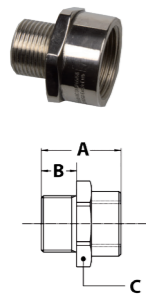

NPT / NPT enlarger, stainless steel AISI-316



OUTSIDE THREAD	INSIDE THREAD	MIN. INTERNAL BORE (MM)	DIMENSIONS IN MM					STANDARD PACKAGE	ARTICLE NUMBER	WEIGHT (KG/100)
			A	B	C	D	E			
NPT 1/2"	NPT 3/4"	-	29	18	27	-	-	10	781.816.8	-
NPT 1/2"	NPT 1"	-	40	18	40	-	-	10	781.818.8	-
NPT 3/4"	NPT 1"	-	40	22	40	-	-	5	781.820.8	-
NPT 3/4"	NPT 1.1/4"	-	40	22	45	-	-	5	781.822.8	-
NPT 1"	NPT 1.1/4"	-	40	22	45	-	-	5	781.826.8	-
NPT 1"	NPT 1.1/2"	-	42	22	55	-	-	5	781.828.8	-
NPT 1.1/4"	NPT 1.1/2"	-	42	24	55	-	-	2	781.835.8	-
NPT 1.1/4"	NPT 2"	-	42	24	70	-	-	2	781.838.8	-
NPT 1.1/2"	NPT 2"	-	42	24	70	-	-	1	781.840.8	-



NPT / NPT coupling, female / female, stainless steel AISI-316



INSIDE THREAD	INSIDE THREAD	MIN. INTERNAL BORE (MM)	DIMENSIONS IN MM					STANDARD PACKAGE	ARTICLE NUMBER	WEIGHT (KG/100)
			A	B	C	D	E			
NPT 1/2"	NPT 1/2"	-	-	-	-	-	-	10	782.716.8	-
NPT 3/4"	NPT 3/4"	-	-	-	-	-	-	10	782.720.8	-
NPT 1"	NPT 1"	-	-	-	-	-	-	5	782.726.8	-
NPT 1.1/4"	NPT 1.1/4"	-	-	-	-	-	-	2	782.735.8	-
NPT 1.1/2"	NPT 1.1/2"	-	-	-	-	-	-	1	782.740.8	-
NPT 2"	NPT 2"	-	-	-	-	-	-	1	782.750.8	-

## ANACONDA IECEX-ATEX, ACCESSORIES, STAINLESS STEEL



NPT / NPT nipple, male / male, stainless steel AISI-316



OUTSIDE THREAD	OUTSIDE THREAD	MIN. INTERNAL BORE (MM)	DIMENSIONS IN MM					STANDARD PACKAGE	ARTICLE NUMBER	WEIGHT (KG/100)
			A	B	C	D	E			
NPT 1/2"	NPT 1/2"	-	-	-	-	-	-	10	781.716.8	-
NPT 3/4"	NPT 3/4"	-	-	-	-	-	-	5	781.720.8	-
NPT 1"	NPT 1"	-	-	-	-	-	-	5	781.726.8	-
NPT 1.1/4"	NPT 1.1/4"	-	-	-	-	-	-	2	781.735.8	-
NPT 1.1/2"	NPT 1.1/2"	-	-	-	-	-	-	1	781.740.8	-
NPT 2"	NPT 2"	-	-	-	-	-	-	1	781.750.8	-



Blind plug, stainless steel AISI-316, ISO



OUTSIDE THREAD	INSIDE THREAD	MIN. INTERNAL BORE (MM)	DIMENSIONS IN MM					STANDARD PACKAGE	ARTICLE NUMBER	WEIGHT (KG/100)
			A	B	C	D	E			
M16 x 1,5	-	-	21	15	22	-	-	10	781.316.8	-
M20 x 1,5	-	-	21	15	26	-	-	10	781.320.8	-
M25 x 1,5	-	-	21	15	30	-	-	5	781.325.8	-
M32 x 1,5	-	-	21	15	40	-	-	5	781.332.8	-
M40 x 1,5	-	-	21	15	48	-	-	2	781.340.8	-
M50 x 1,5	-	-	21	15	60	-	-	1	781.350.8	-
M63 x 1,5	-	-	21	15	70	-	-	1	781.363.8	-
M75 x 1,5	-	-	28	20	80	-	-	1	781.375.8	-

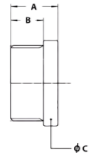

Blind plug, stainless steel AISI-316, NPT



OUTSIDE THREAD	INSIDE THREAD	MIN. INTERNAL BORE (MM)	DIMENSIONS IN MM					STANDARD PACKAGE	ARTICLE NUMBER	WEIGHT (KG/100)
			A	B	C	D	E			
NPT 1/2"	-	-	24	18	22	-	-	10	781.416.8	-
NPT 3/4"	-	-	24	18	26	-	-	5	781.420.8	-
NPT 1"	-	-	28	22	34	-	-	5	781.426.8	-
NPT 1.1/4"	-	-	28	22	42	-	-	2	781.435.8	-
NPT 1.1/2"	-	-	-	24	48	-	-	1	781.440.8	-
NPT 2"	-	-	-	24	65	-	-	1	781.450.8	-

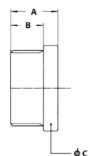

Atex fittings



Blind plug, stainless steel AISI-316, Pg



OUTSIDE THREAD	INSIDE THREAD	MIN. INTERNAL BORE (MM)	DIMENSIONS IN MM					STANDARD PACKAGE	ARTICLE NUMBER	WEIGHT (KG/100)
			A	B	C	D	E			
Pg 11	-	-	21	15	26	-	-	10	781.511.8	-
Pg 13,5	-	-	21	15	26	-	-	10	781.513.8	-
Pg 16	-	-	21	15	30	-	-	10	781.516.8	-
Pg 21	-	-	21	15	35	-	-	5	781.521.8	-
Pg 29	-	-	21	15	45	-	-	5	781.529.8	-
Pg 36	-	-	21	15	55	-	-	2	781.536.8	-
Pg 42	-	-	28	20	60	-	-	1	781.542.8	-
Pg 48	-	-	28	20	65	-	-	1	781.548.8	-



# Anaconda IECEx-ATEX, accessories



2 component epoxy resin for BX fittings, BXC adapters and BXN cable-glands (50 gr)



OUTSIDE THREAD	INSIDE THREAD	MIN. INTERNAL BORE (MM)	DIMENSIONS IN MM					STANDARD PACKAGE	ARTICLE NUMBER	WEIGHT (KG/100)
A	B	C	D	E						
-	-	-	-	-	-	-	-	10	827.999.1	-

The 2 component epoxy resin is provided in a package with 2 separate parts:

**1. Epoxy putty hardener.**

**2. Epoxy putty resin.**

The epoxy resin is provided in a package with two separate parts. These must be mixed in a ratio of 1:1 until the compound is a single colour and without streaks. The best solution for mixing the two parts is by rolling and bending the components several times together. Once mixed, the resin must be used within 30 minutes. Over time it will begin to harden. 3 to 4 hours are necessary at a temperature of between 20°C to 30°C for the compound to solidify. The curing process will take between 12-24 hours at a temperature between 20°C and 30°C for the compound to reach an optimal state. The compound, when completely set, is suitable to use at a range of service temperatures from -60°C to +130°C.

**Precautions:**

When using the compound, be sure to wear the gloves provided with the resin. The compound should not be stored at a temperature below 20°C before being mixed. At lower temperatures, it will become difficult to mix. If the compound comes in contact with the skin, it must be removed with a detergent and in no case allowed to harden. A Material Safety Data Sheet is available on demand. Note: Also consider that the setting time may be longer when the room temperature is below 20°C.

Type BXA, BXC, BXN max diameter cables and conductors

THREAD ISO	THREAD PG	THREAD NPT	SEALTITE SIZE	MIN. INTERNAL BORE (MM)	MAX Ø OVER MULTI CORE (MM)	MAX Ø OVER SINGLE CORE (MM)	CONDUCTORS MAX.	EPOXY RESIN NEEDED	MAX. USAGE
M16	Pg 11	1/2"	3/8"	10,4	9,4	8	10	1 x	50 gr
M20	Pg 13,5	1/2"	3/8"	10,4	9,4	8	10	1 x	50 gr
M20	Pg 16	1/2"	1/2"	13,8	12,4	10,5	15	1 x	50 gr
M25	Pg 21	3/4"	3/4"	18,5	17,6	14	30	1 x	50 gr
M32	Pg 29	1"	1"	23,8	22,8	18,5	50	1 x	50 gr
M40	Pg 36	1.1/4"	1.1/4"	31,9	28	24,5	75	2 x	100 gr
M50	Pg 36	1.1/2"	1.1/2"	38	34,5	29,5	80	2 x	100 gr

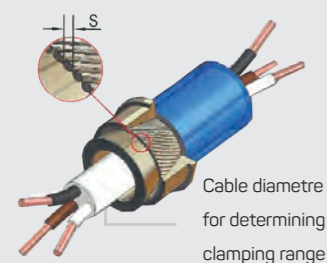

Cable diameter for determining clamping range

**Special information for EMC cable-hose fittings and cable-glands**

1. In case of EMC versions, the cable diameter needed to determine the clamping range, is not the outer diameter of the cable but the diameter of the cable without the braiding.
2. In case of EMC versions with a wire diameter (S) from 1,0 till 2,5 mm (type SWA, Steel Wire Armour) a special version with reduced cone clamping rings must be ordered (article no. with suffix "-RC").

## ANACONDA IECEX-ATEX, ACCESSORIES

### General information on cable-hose fittings and cable-glands

Sizes and torques of the various fittings

For mounting the fitting or cable-gland on the switchbox / junction box

SIZE	MALE BODY		TORQUE (NM)	THREAD SIZE				
	SW (Hex)	Diam (Ø)		ISO 262	DIN 40430	NPT	ISO 228	ISO 10226
16	24	26	4	M 16x1,5	Pg 11	3/8"	G 3/8"	R 3/8"
				M 20x1,5		1/2"	G 1/2"	R 1/2"
20	30	33	6	M 20x1,5	Pg 13,5	1/2"	G 1/2"	R 1/2"
25	35	38	8	M 25x1,5	Pg 16	3/4"	G 3/4"	R 3/4"
32	42	47	12	M 32x1,5	Pg 21	1"	G 1"	R 1"
40	48	53	24	M 40x1,5	Pg 29	1.1/4"	G 1.1/4"	R 1.1/4"
50	55	60	30	M 50x1,5	Pg 36	1.1/2"	G 1.1/2"	R 1.1/2"
63	68	74	40	M 63x1,5	Pg 42	2"	G 2"	R 2"

For tightening the sealing rubber (not applicable for BXA, BXC and BXN barrier types)

SIZE	INT. BODY/NUT		TORQUE (NM)	THREAD SIZE				
	SW (Hex)	Diam (Ø)		ISO 262	DIN 40430	NPT	ISO 228	ISO 10226
16	25	27	17	M 16x1,5	Pg 11	3/8"	G 3/8"	R 3/8"
				M 20x1,5		1/2"	G 1/2"	R 1/2"
20	32	35	23	M 20x1,5	Pg 13,5	1/2"	G 1/2"	R 1/2"
25	36	39	29	M 25x1,5	Pg 16	3/4"	G 3/4"	R 3/4"
32	45	49	33	M 32x1,5	Pg 21	1"	G 1"	R 1"
40	50	55	41	M 40x1,5	Pg 29	1.1/4"	G 1.1/4"	R 1.1/4"
50	57	62	50	M 50x1,5	Pg 36	1.1/2"	G 1.1/2"	R 1.1/2"
63	68	74	75	M 63x1,5	Pg 42	2"	G 2"	R 2"

Atex fittings

For mounting the fitting on the flexible conduit

SIZE	BODY		TORQUE (NM)	THREAD SIZE				
	SW (Hex)	Diam (Ø)		ISO 262	DIN 40430	NPT	ISO 228	ISO 10226
3/8"	26	29	27	M 16x1,5	Pg 11	3/8"	G 3/8"	R 3/8"
				M 20x1,5		1/2"	G 1/2"	R 1/2"
1/2"	30	33	34	M 20x1,5	Pg 13,5	1/2"	G 1/2"	R 1/2"
3/4"	35	39	57	M 25x1,5	Pg 16	3/4"	G 3/4"	R 3/4"
1"	45	50	79	M 32x1,5	Pg 21	1"	G 1"	R 1"
1.1/4"	55	60	113	M 40x1,5	Pg 29	1.1/4"	G 1.1/4"	R 1.1/4"





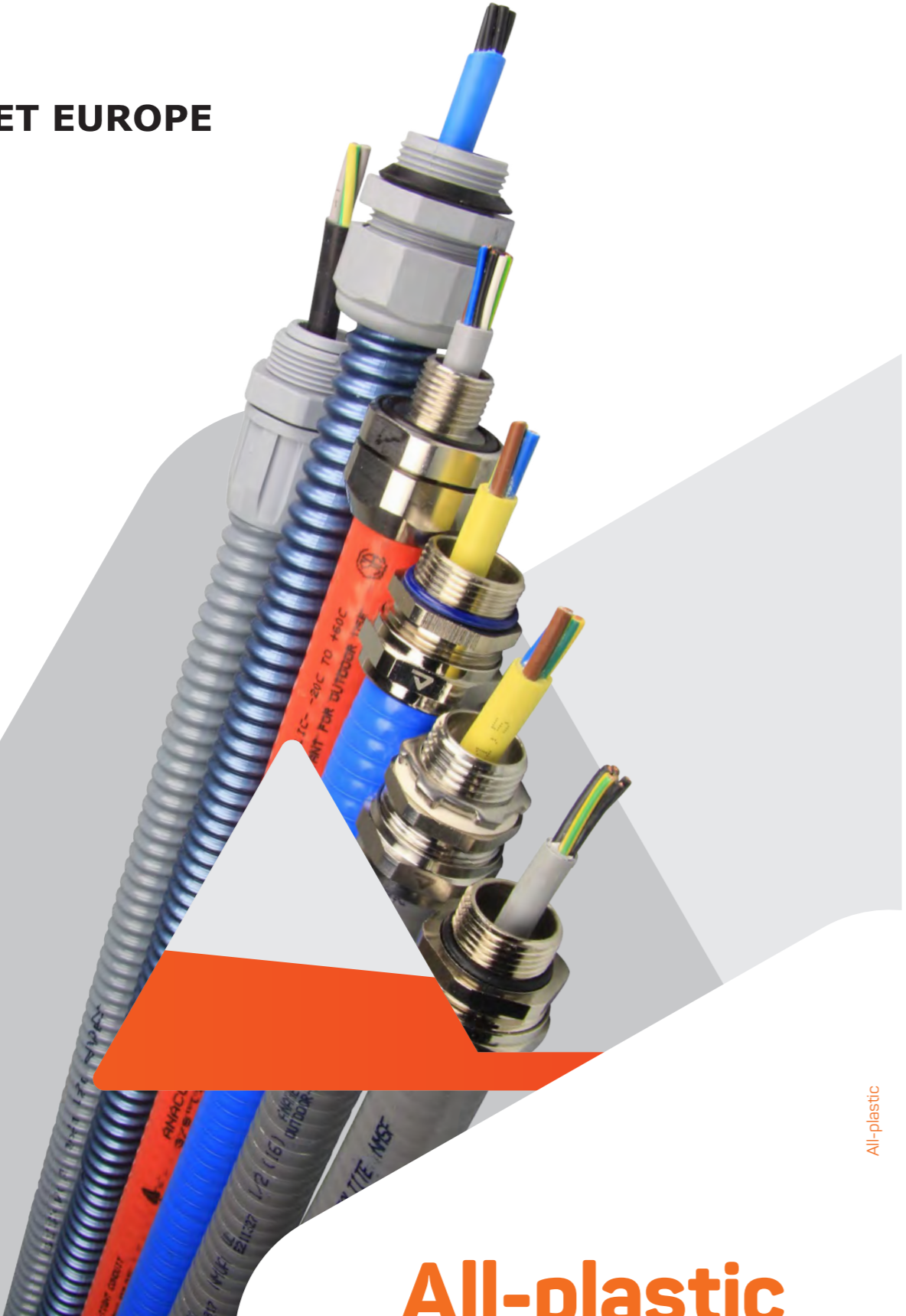

















All-plastic

# All-plastic



# Conduit selection table

## Anamet All-Plastic system

ALL-PLASTIC	MATERIAL	MATERIAL	TEMPERATURE		RESISTANCE (NEN-EN-IEC 61386)			FLEXI- BILITY	RESISTANCE		APPROVALS	PROTEC- TION	PAGE
			Min.	Max.	Compr.	Impact	Tensile		UV	Oil			
<b>CNP Orange</b>	PVC, Nylon reinforced RoHS	PVC RoHS	-20 °C	+60 °C	1 (125N)	3 (2J)	4 (1000N)	++	++++	++++	  	IP 66 IP 67	8 - 3
<b>CNP Grey</b>	PVC, Nylon reinforced RoHS	PVC RoHS	-20 °C	+60 °C	1 (125N)	3 (2J)	4 (1000N)	++	++++	++++	  	IP 66 IP 67	8 - 4
<b>NMUA Grey</b>	PVC, PVC reinforced RoHS	-	-20 °C	+80 °C	2 (320N)	3 (2J)	4 (1000N)	+++	++++	+++	  	IP 66 IP 67	8 - 7
<b>NMSF Grey</b>	PVC, PVC reinforced RoHS	-	-20 °C	+80 °C	1 (125N)	3 (2J)	4 (1000N)	++++	+++	+++	 	IP 66 IP 67	8 - 8
<b>NMFG Blue</b>	PVC, PVC reinforced RoHS	-	-35 °C	+60 °C	1 (125N)	3 (2J)	4 (1000N)	++++	+++	+++	  	IP 66 IP 67	8 - 13
<b>MPC Grey</b>	Metal spiral	PVC RoHS	-20 °C	+70 °C	3 (750N)	3 (2J)	1 (100N)	++++	+++	++		IP 66 IP 67	8 - 20
<b>MPU Blue</b>	Metal spiral	TPU Halogen free RoHS	-40 °C	+90 °C	3 (750N)	3 (2J)	1 (100N)	++++	+++	++++		IP 66 IP 67	8 - 21

Fittings are listed on the page following the description of the relevant conduit(s).

# Anaconda Sealbite conduit

## TYPE CNP ORANGE



### ALL-PLASTIC, ROBUST, UL & CSA APPROVED (TYPE A)

Type CNP is designed for use in heavy duty applications. The conduit features a smooth inner thermoplastic PVC core with outer PVC cover which is bonded with nylon reinforcing braid, a construction designed to withstand abrasion, corrosion, oil, chemicals and UV exposure and handle frequent movement. UL and CSA approved, type CNP is also suitable for use on machines, equipment and installations exported outside of Europe. When used in combination with Anamet CNP fittings an IP 67 leak-tight cable protection system with a strong pull out strength is achieved.

#### Material & Construction:

**Construction:** Thick smooth thermoplastic (PVC compound) core, with braided nylon reinforcement and thick smooth thermoplastic (PVC compound) cover.

**Cover specifications:** PVC, lead-free according to RoHS, nylon reinforced, smoothbore in- and outside, sunlight and UV resistant, suitable for

outside installation. The cover is resistant against oil and greases.

**Special approvals:** UL- 1660, type A (file # E 75863) and CSA C22.2 (file # 15275).

**Temperature:** -20 °C till +60 °C, intermittent up to +80 °C. For CSA -18 °C till +75 °C.

**Colour:** Orange (grey is also available).

#### Classification according to NEN-EN-IEC 61386:

**Compression resistance:** Class 1, Very light (125 N).

**Impact resistance:** Class 3, Medium (2 J).

**Tensile strength:** Class 4, Heavy (1000 N).

**Protection class:** IP 66 / 67 (dust-proof, water-tight).



Nylon reinforced PVC

All-plastic

SEALTITE	DIAMETRE		BENDING RADIUS		STANDARD CARTON		SMALL CARTON		REELS		WEIGHT (kg/m)
	Size (inch)	Inside (mm)	Outside (mm)	Static (mm)	Dynamic (mm)	Metre	Article No. orange	Metre	Article No. orange	Metre	
3/8"	12,6	19,4	70	100	76	321.012.1	-	-	-	-	0,41
1/2"	16,1	23,4	90	125	60	321.016.1	-	-	-	-	0,43
3/4"	21	29,5	115	160	53	321.020.1	-	-	-	-	0,47
1"	26,5	36,3	170	200	30	321.026.1	-	-	-	-	0,65
1 1/4"	35,1	46	200	240	15	321.035.1	-	-	-	-	0,87
1 1/2"	40,7	52,4	230	290	15	321.040.1	-	-	-	-	1,22
2"	52,4	66,6	260	350	15	321.050.1	-	-	-	-	1,81

The fittings for Sealbite CNP are outlined on pages 8 - 5 till 8 - 6

SEALTITE	1/4"	5/16"	3/8"	1/2"	3/4"	1"	1 1/4"	1 1/2"	2"	2 1/2"	3"	4"
ISO	-	-	M16 - M20	M20	M25	M32	M40	M50	M50 - M63	-	-	-
Pg	-	-	-	-	-	-	-	-	-	-	-	-
NPT	-	-	1/2"	1/2"	3/4"	1"	1 1/4"	1 1/2"	2"	-	-	-

# Anaconda Sealrite conduit

## TYPE CNP GREY



### ALL-PLASTIC, ROBUST, UL & CSA APPROVED (TYPE A)

Type CNP is designed for use in heavy duty applications. The conduit features a smooth inner thermoplastic PVC core with outer PVC cover which is bonded with nylon reinforcing braid, a construction designed to withstand abrasion, corrosion, oil, chemicals and UV exposure and handle frequent movement. UL and CSA approved, type CNP is also suitable for use on machines, equipment and installations exported outside of Europe. When used in combination with Anamet CNP fittings an IP 67 leak-tight cable protection system with a strong pull out strength is achieved.

#### Material & Construction:

**Construction:** Thick smooth thermoplastic (PVC compound) core, with braided nylon reinforcement and thick smooth thermoplastic (PVC compound) cover.

**Cover specifications:** PVC, lead-free according to RoHS, nylon reinforced, smoothbore in- and outside, sunlight and UV resistant, suitable for

outside installation. The cover is resistant against oil and greases.

**Special approvals:** UL- 1660, type A (file # E 75863) and CSA C22.2 (file # 15275).

**Temperature:** -20 °C till +60 °C, intermittent up to +80 °C. For CSA -18 °C till +75 °C.

**Colour:** Grey (orange is also available).

#### Classification according to NEN-EN-IEC 61386:

**Compression resistance:** Class 1, Very light (125 N).

**Impact resistance:** Class 3, Medium (2 J).

**Tensile strength:** Class 4, Heavy (1000 N).

**Protection class:** IP 66 / 67 (dust-proof, water-tight).



Nylon reinforced PVC

SEALRITE	DIAMETRE		BENDING RADIUS		STANDARD CARTON		SMALL CARTON		REELS		WEIGHT
	Size (inch)	Inside (mm)	Outside (mm)	Static (mm)	Dynamic (mm)	Metre	Article No. grey	Metre	Article No. grey	Metre	
3/8"	12,6	19,4	70	100	76	313.012.1	-	-	-	-	0,41
1/2"	16,1	23,4	90	125	60	313.016.1	-	-	-	-	0,43
3/4"	21	29,5	115	160	53	313.020.1	-	-	-	-	0,47
1"	26,5	36,3	170	200	30	313.026.1	-	-	-	-	0,65
1.1/4"	35,1	46	200	240	15	313.035.1	-	-	-	-	0,87
1.1/2"	40,7	52,4	230	290	15	313.040.1	-	-	-	-	1,22
2"	52,4	66,6	260	350	15	313.050.1	-	-	-	-	1,81

The fittings for Sealrite CNP are outlined on pages 8 - 5 till 8 - 6

SEALRITE	1/4"	5/16"	3/8"	1/2"	3/4"	1"	1.1/4"	1.1/2"	2"	2.1/2"	3"	4"
ISO	-	-	M16 - M20	M20	M25	M32	M40	M50	M50 - M63	-	-	-
Pg	-	-	-	-	-	-	-	-	-	-	-	-
NPT	-	-	1/2"	1/2"	3/4"	1"	1.1/4"	1.1/2"	2"	-	-	-

# Anamet fittings for CNP, IP 67, galvanised steel



## ANAMET GALVANISED STEEL FITTINGS FOR SEALTITE TYPE CNP

This galvanised steel fitting is exclusively designed for use with a heavy wall conduit like type CNP. As with the conduit, the fitting is UL and CSA approved and meets the required criteria for countries outside Europe that recognise and uphold these approvals. When used in combination with type CNP conduit an IP 67 leak-tight cable protection system with a strong pull out strength is achieved.

### Material & Construction:

**Construction:** Galvanised steel fitting, consisting of 3 parts (counter nut, ferrule and body).

**Material:** Counter nut, and body are galvanised steel. The ferrule and insert are from PA6 (white for NPT).

**Temperature:** -45 °C till +105 °C continuous.

**Protection class:** IP 67 (dust-proof, water-tight).

**Colour:** Metal coloured.



NPT straight fitting, male, galvanised steel (including NPT lock nut)

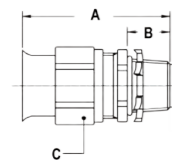

THREAD NPT	CNP SIZE (INCH)	MIN. INTERNAL BORE (MM)	DIMENSIONS IN MM					STANDARD PACKAGE	ARTICLE NUMBER	WEIGHT (KG/100)
			A	B	C	D	E			
NPT 1/2"	3/8"	11	55	15	27	-	-	25	298.312.0	10,2
NPT 1/2"	1/2"	14	66	15	32	-	-	25	298.316.0	14,7
NPT 3/4"	3/4"	18	66	15	39	-	-	25	298.320.0	20,2
NPT 1"	1"	25	73	18	45	-	-	5	298.326.0	29,2
NPT 1.1/4"	1.1/4"	34	87	19	59	-	-	5	298.335.0	54
NPT 1.1/2"	1.1/2"	39	87	19	67	-	-	2	298.340.0	63
NPT 2"	2"	50	101	19	82	-	-	1	298.350.0	108

All-plastic



NPT 90° fitting, male, galvanised steel (including NPT lock nut)

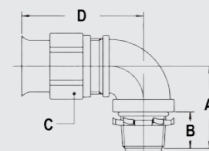

THREAD NPT	CNP SIZE (INCH)	MIN. INTERNAL BORE (MM)	DIMENSIONS IN MM					STANDARD PACKAGE	ARTICLE NUMBER	WEIGHT (KG/100)
			A	B	C	D	E			
NPT 1/2"	3/8"	11	32	15	29	52	-	25	298.712.0	13,6
NPT 1/2"	1/2"	14	33	15	33	60	-	25	298.716.0	17,2
NPT 3/4"	3/4"	18	37	15	41	64	-	25	298.720.0	29,9
NPT 1"	1"	25	44	18	49	70	-	5	298.726.0	36,8
NPT 1.1/4"	1.1/4"	34	50	19	61	88	-	5	298.735.0	69,6
NPT 1.1/2"	1.1/2"	39	57	19	71	91	-	2	298.740.0	92
NPT 2"	2"	50	64	19	86	112	-	1	298.750.0	142

# Anamet fittings for CNP, IP 67, stainless steel



## ANACONDA STAINLESS STEEL FITTINGS FOR SEALTITE CNP

This Anaconda stainless steel fitting is exclusively designed for use with type CNP. While the stainless steel construction provides excellent performance in corrosive environments, the hygienic design of the fitting with its smooth profile promotes easy clean down when used to protect cables on machines, equipment and installations in the food and pharmaceutical industries. When used in combination with type CNP conduit an IP 67 leak-tight cable protection system with a strong pull out strength is achieved.

### Material & Construction:

**Construction:** Stainless steel (AISI-303) fitting, consisting of 4 parts (counter nut, clamping ring, ferrule and body).

**Material:** Counter nut, clamping ring and body are stainless steel (AISI-303), ferrule is from PA6.

**Temperature:** -45 °C till +105 °C continuous.

**Protection class:** IP 67 (dust-proof, water-tight).

**Colour:** Metal coloured.

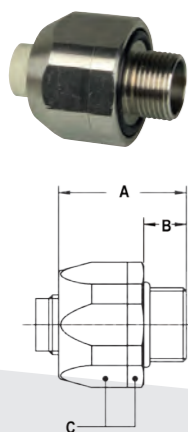

ISO straight fitting, male, stainless steel (AISI-303)



THREAD ISO	CNP SIZE (INCH)	MIN. INTERNAL BORE (MM)	DIMENSIONS IN MM					STANDARD PACKAGE	ARTICLE NUMBER	WEIGHT (KG/100)
			A	B	C	D	E			
M16 x 1,5	3/8"	10,5	37	13	30	-	-	10	828.016.9	7,8
M20 x 1,5	1/2"	13,5	42	13	36	-	-	10	828.020.9	11
M25 x 1,5	3/4"	18	44	15	41	-	-	5	828.025.9	17
M32 x 1,5	1"	24,5	48	15	50	-	-	5	828.032.9	34
M40 x 1,5	1.1/4"	33,5	57	16	60	-	-	2	828.040.9	40
M50 x 1,5	1.1/2"	38,5	64	19	66	-	-	1	828.050.9	85
M63 x 1,5	1.1/2"	38,5	64	19	81	-	-	1	828.060.9	108
M63 x 1,5	2"	49,5	75	19	81	-	-	1	828.063.9	112

# Anaconda Sealbite conduit

## TYPE NMUA GREY



### ALL-PLASTIC, MEDIUM MECHANICAL STRENGTH, FLEXIBLE, UL & CSA APPROVED (TYPE B)

Type NMUA is a lead-free, PVC flexible conduit which provides good mechanical protection of cables in applications where the conduit is not exposed to extreme demands or conditions. Typical areas of application include the food, pharmaceutical and machine and apparatus building industries. When used in combination with an Anamet polyamide fitting an IP 67 leak-tight cable protection system with a strong pull out strength is achieved. Type NMUA is UL and CSA (type B) approved and meets the required criteria for countries outside Europe that recognise and uphold these approvals.

#### Material & Construction:

**Construction:** Thick smooth thermoplastic (PVC compound) core reinforced with PVC spiral.

**Cover specifications:** PVC, smoothbore in- and outside, with PVC spiral reinforced, lead-free according to RoHS, sunlight and UV resistant, suitable for outside and burial installation.

**Special approvals:** UL- 1660 type B (file # E 211327) and CSA C22.2 (file # 20817).

**Temperature:** -20 °C till +80 °C, intermittent up to +100 °C. For CSA -18 °C till +75 °C.

**Colour:** Grey.

#### Classification according to NEN-EN-IEC 61386:

**Compression resistance:** Class 2, Light (320 N).

**Impact resistance:** Class 3, Medium (2 J).

**Tensile strength:** Class 4, Heavy (1000 N).

**Protection class:** IP 66 / 67 (dust-proof, water-tight).



Spiral reinforced PVC

SEALBITE	DIAMETRE		BENDING RADIUS		STANDARD CARTON		SMALL CARTON		REELS		WEIGHT (kg/m)
	Size (inch)	Inside (mm)	Outside (mm)	Static (mm)	Dynamic (mm)	Metre	Article No. grey	Metre	Article No. grey	Metre	
3/8"	12,6	17,8	70	100	30	300.012.0	-	-	-	-	0,13
1/2"	16	21,1	100	135	30	300.016.0	-	-	-	-	0,2
3/4"	21,1	26,4	130	175	30	300.020.0	-	-	-	-	0,3
1"	26,8	33,1	180	220	30	300.026.0	-	-	-	-	0,38
1.1/4"	35,4	41,8	225	270	15	300.035.0	-	-	-	-	0,55
1.1/2"	40,3	47,8	255	320	15	300.040.0	-	-	-	-	0,7
2"	51,6	59,9	310	400	15	300.050.0	-	-	-	-	1

All-plastic

The fittings for Sealbite NMUA are outlined on pages 8 - 9 till 8 - 12  
Sealbite fittings illustrated in chapter 5 can also be used

SEALBITE	1/4"	5/16"	3/8"	1/2"	3/4"	1"	1.1/4"	1.1/2"	2"	2.1/2"	3"	4"
ISO	M10 - M12	M16 - M20	M16 - M20	M20	M25	M32	M40	M50 - M63	M50 - M63	M75	M90	-
Pg	7	9 - 11	11/13,5	16	21	29	36	42	48	-	-	-
NPT	-	-	1/2"	1/2"	3/4"	1"	1.1/4"	1.1/2"	2"	2.1/2"	3"	4"



# Anaconda Sealbite conduit



## TYPE NMSF GREY

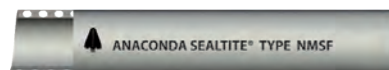

### ALL-PLASTIC, MEDIUM MECHANICAL STRENGTH, SOFT FLEXIBLE

Type NMSF is constructed of lead-free, PVC plastic. The conduit cover is softer and more flexible than type NMUA, a design that provides good mechanical protection of cables in less demanding applications such as the general machine and apparatus building industries. When used in combination with an Anamet polyamide fitting an IP 67 leak-tight cable protection system with a strong pull out strength is achieved. Type NMSA is not UL or CSA approved.

#### Material & Construction:

**Construction:** Thick smooth thermoplastic (PVC compound) core reinforced with PVC spiral.

**Temperature:** -20 °C till +80 °C, intermittent up to +100 °C.

**Cover specifications:** PVC, smoothbore in- and outside, with PVC spiral reinforced, lead-free according to RoHS, sunlight and UV resistant, suitable for outside and burial installation.

**Colour:** Grey.

#### Classification according to NEN-EN-IEC 61386:

**Compression resistance:** Class 1, Very Light (125 N).

**Impact resistance:** Class 3, Medium (2 J).

**Tensile strength:** Class 4, Heavy (1000 N).

**Protection class:** IP 66 / 67 (dust-proof, water-tight).



Spiral reinforced PVC

SEALTITE	DIAMETRE		BENDING RADIUS		STANDARD CARTON		SMALL CARTON		REELS		WEIGHT
	Size (inch)	Inside (mm)	Outside (mm)	Static (mm)	Dynamic (mm)	Metre	Article No. grey	Metre	Article No. grey	Metre	
3/8"	12,6	17,8	70	100	30	325.012.0	-	-	-	-	0,12
1/2"	16	21,1	100	135	30	325.016.0	-	-	-	-	0,18
3/4"	21,1	26,4	130	175	30	325.020.0	-	-	-	-	0,28
1"	26,8	33,1	180	220	30	325.026.0	-	-	-	-	0,34
1.1/4"	35,4	41,8	225	270	15	325.035.0	-	-	-	-	0,46
1.1/2"	40,3	47,8	255	320	15	325.040.0	-	-	-	-	0,6
2"	51,6	59,9	310	400	15	325.050.0	-	-	-	-	0,8

The fittings for Sealbite NMSF are outlined on pages 8 - 9 till 8 - 12  
Sealbite fittings illustrated in chapter 5 can also be used

SEALTITE	1/4"	5/16"	3/8"	1/2"	3/4"	1"	1.1/4"	1.1/2"	2"	2.1/2"	3"	4"
ISO	M10 - M12	M16 - M20	M16 - M20	M20	M25	M32	M40	M50 - M63	M50 - M63	M75	M90	-
Pg	7	9 - 11	11/13,5	16	21	29	36	42	48	-	-	-
NPT	-	-	1/2"	1/2"	3/4"	1"	1.1/4"	1.1/2"	2"	2.1/2"	3"	4"

# Anamet fittings for all plastic, IP 67, polyamide



## ANAMET, HALOGEN FREE, POLYAMIDE FITTINGS FOR ANACONDA SEALTITE NMUA / NMSF / NMFG

Anamet polyamide PA6 fittings are designed for use with conduit types NMUA / NMSF and NMFG. When used in combination with one of these conduits an IP 67 leak-tight cable protection system with a strong pull strength is achieved. UL and CSA approved, the fittings meet the criteria for countries outside Europe that recognise and uphold these approvals.

### Material & Construction:

**Construction:** Plastic fitting, consisting of 2 parts (counter nut and body).

**Material:** Polyamide PA6, V-2, halogen free.

**Special approvals:** UL- 1660, type A (file # E234207) and CSA C22.2 (file #E234207).

**Temperature:** -40 °C till +120 °C continuous.

**Protection class:** IP 67 (dust-proof, water-tight).

**Colour:** Grey.

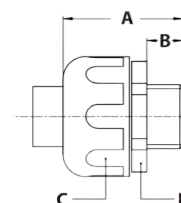

ISO straight fitting, male, PA6



THREAD ISO	SEALTITE SIZE (INCH)	MIN. INTERNAL BORE (MM)	DIMENSIONS IN MM					STANDARD PACKAGE	ARTICLE NUMBER	WEIGHT (KG/100)
			A	B	C	D	E			
M16 x 1,5	3/8"	10,9	47	14	35	-	33	25	263.016.0	2
M20 x 1,5	1/2"	14,4	47	14	35	-	33	25	263.020.0	2,3
M25 x 1,5	3/4"	18	49	16	43	-	39	10	263.025.0	3,4
M32 x 1,5	1"	23,9	53	16	49	-	44	5	263.032.0	5,8
M40 x 1,5	1.1/4"	31,8	45	16	54	-	-	5	300.140.0*	-

\* Size M40 is without UL / CSA approval and the shape is different from the picture.

All-plastic

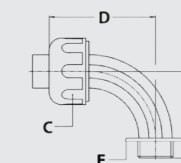

ISO 90° fitting, male, PA6



THREAD ISO	SEALTITE SIZE (INCH)	MIN. INTERNAL BORE (MM)	DIMENSIONS IN MM					STANDARD PACKAGE	ARTICLE NUMBER	WEIGHT (KG/100)
			A	B	C	D	E			
M16 x 1,5	3/8"	10,9	30	13	35	60	31	10	263.116.0	2,4
M20 x 1,5	1/2"	14,4	30	13	35	60	31	10	263.120.0	2,9
M25 x 1,5	3/4"	18	40	14	43	68	37	10	263.125.0	4,1
M32 x 1,5	1"	23,9	50	16	49	82	45	5	263.132.0	6,7

## ANAMET FITTINGS FOR ALL PLASTIC, IP 67, POLYAMIDE

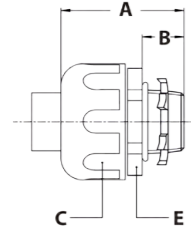

NPT straight fitting, male, PA6 (including seal and lock nut)



THREAD NPT	SEALTITE SIZE (INCH)	MIN. INTERNAL BORE (MM)	DIMENSIONS IN MM					STANDARD PACKAGE	ARTICLE NUMBER	WEIGHT (KG/100)
			A	B	C	D	E			
1/2"	3/8"	10,9	47	14	35	-	33	25	263.312.0	2,3
1/2"	1/2"	14,4	47	14	35	-	33	25	263.316.0	2,6
3/4"	3/4"	18	49	16	43	-	39	10	263.320.0	3,8
1"	1"	23,9	53	16	49	-	44	5	263.326.0	6,3
1.1/4"	1.1/4"	30,6	60	18	59	-	55	5	263.335.0	9,5
1.1/2"	1.1/2"	35,4	64	19	66	-	61	1	263.340.0	10,3
2"	2"	47,8	72	21	83	-	79	1	263.350.0	19,5

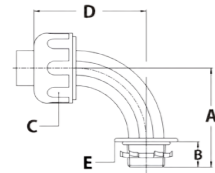

NPT 90° fitting, male, PA6 (including seal and lock nut)



THREAD NPT	SEALTITE SIZE (INCH)	MIN. INTERNAL BORE (MM)	DIMENSIONS IN MM					STANDARD PACKAGE	ARTICLE NUMBER	WEIGHT (KG/100)
			A	B	C	D	E			
1/2"	3/8"	10,9	30	13	35	60	31	10	263.412.0	2,7
1/2"	1/2"	14,4	30	13	35	60	31	10	263.416.0	3,2
3/4"	3/4"	18	40	14	43	68	37	10	263.420.0	4,5
1"	1"	23,9	50	16	49	82	45	5	263.426.0	7,2
1.1/4"	1.1/4"	30,6	68	18	59	84	54	5	263.435.0	14,4
1.1/2"	1.1/2"	35,4	70	19	66	88	59	1	263.440.0	16,8
2"	2"	47,8	73	21	83	90	74	1	263.450.0	27,2

# Compact fittings, IP 66 / IP 67, nickel plated brass



## ANACONDA COMPACT NICKEL PLATED BRASS FITTINGS FOR NMUA / NMSF

Anaconda compact nickel plated brass fittings can also be used in combination with Anaconda conduit types NMUA and NMSF. These compact fittings are lighter and shorter than the Anaconda standard range of fittings. Due to their compact size, the fittings are ideal in tight fit situations where space is limited. When used in combination with either of the above conduits an IP 67 leak-tight cable protection system with a strong pull out strength is achieved, IP 68 on the side of the cabinet.

### Material & Construction:

**Construction:** Nickel plated brass fitting, consisting of 4 parts (counter nut, clamping ring, ferrule and body).

**Material:** Counter nut, body and ferrule are nickel plated brass. Clamping ring is made from PA6.

The O-rings are from NBR rubber (black for ISO and blue for Pg).

**Temperature:** -45 °C till +105 °C continuous.

**Protection class:** IP 66 / 67, Nema 4X.

Cable-hose fittings are IP 68 on the switchbox.

**Colour:** Metal coloured.

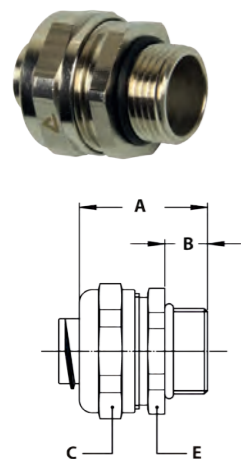

ISO straight fitting, compact, male, nickel plated brass



THREAD ISO	SEALTITE SIZE (INCH)	MIN. INTERNAL BORE (MM)	DIMENSIONS IN MM					STANDARD PACKAGE	ARTICLE NUMBER	WEIGHT (KG/100)
			A	B	C	D	E			
M16 x 1,5	3/8"	10,6	31	10	26	-	24	10	712.016.0-NM	3,9
M20 x 1,5	3/8"	10,6	31	10	26	-	24	10	712.017.0-NM	4
M20 x 1,5	1/2"	14	32	10	29	-	27	10	712.020.0-NM	4,4
M25 x 1,5	3/4"	19,1	33	10	35	-	33	5	712.025.0-NM	6,6
M32 x 1,5	1"	24,3	36	12	45	-	42	5	712.032.0-NM	11,7
M40 x 1,5	1 1/4"	32,7	40	13	53	-	50	2	712.040.0-NM	16
M50 x 1,5	1 1/2"	37,4	46	14	62	-	58	2	712.050.0-NM	25,3
M63 x 1,5	2"	47,9	52	16	76	-	72	2	712.063.0-NM	38,6

All-plastic

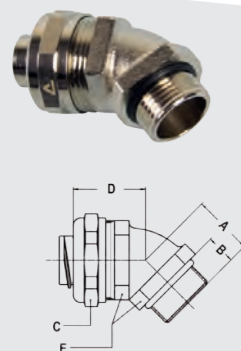

ISO 45° fitting, compact, male, nickel plated brass



THREAD ISO	SEALTITE SIZE (INCH)	MIN. INTERNAL BORE (MM)	DIMENSIONS IN MM					STANDARD PACKAGE	ARTICLE NUMBER	WEIGHT (KG/100)
			A	B	C	D	E			
M16 x 1,5	3/8"	10,6	19	10	26	27	22	10	712.416.0-NM	6,3
M20 x 1,5	3/8"	10,6	20	10	26	28	24	10	712.417.0-NM	7,2
M20 x 1,5	1/2"	14	21	10	29	30	27	10	712.420.0-NM	8,3
M25 x 1,5	3/4"	19,1	23	10	35	33	33	5	712.425.0-NM	12,8
M32 x 1,5	1"	24,3	28	12	45	38	42	5	712.432.0-NM	22,5
M40 x 1,5	1 1/4"	32,7	33	13	53	39	52	2	712.440.0-NM	34,5
M50 x 1,5	1 1/2"	37,4	35	14	62	46	60	2	712.450.0-NM	50
M63 x 1,5	2"	47,9	40	16	76	53	72	2	712.463.0-NM	80,5

## COMPACT FITTINGS, IP 66 / IP 67, NICKEL PLATED BRASS

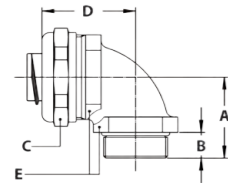

ISO 90° fitting, compact, male, nickel plated brass



THREAD ISO	SEALTITE SIZE (INCH)	MIN. INTERNAL BORE (MM)	DIMENSIONS IN MM					STANDARD PACKAGE	ARTICLE NUMBER	WEIGHT (KG/100)
			A	B	C	D	E			
M16 x 1,5	3/8"	10,6	26	10	26	31	22	10	712.916.0-NM	6,6
M20 x 1,5	3/8"	10,6	26	10	26	32	24	10	712.917.0-NM	7,9
M20 x 1,5	1/2"	14	28	10	29	34	27	10	712.920.0-NM	9,2
M25 x 1,5	3/4"	19,1	32	10	35	40	33	5	712.925.0-NM	16,2
M32 x 1,5	1"	24,3	40	12	45	49	42	5	712.932.0-NM	27,8
M40 x 1,5	1.1/4"	32,7	46	13	53	53	52	2	712.940.0-NM	40,1
M50 x 1,5	1.1/2"	37,4	52	14	62	57	60	2	712.950.0-NM	57,5
M63 x 1,5	2"	47,9	62	16	76	68	72	2	712.963.0-NM	90,6



Ferrule for non-metallic conduit, nickel plated brass



THREAD ISO	SEALTITE SIZE (INCH)	MIN. INTERNAL BORE (MM)	DIMENSIONS IN MM					STANDARD PACKAGE	ARTICLE NUMBER	WEIGHT (KG/100)
			A	B	C	D	E			
-	3/8"	10,6	-	-	-	-	-	10	815.011.6	0,8
-	1/2"	14	-	-	-	-	-	10	815.016.6	1,1
-	3/4"	19,1	-	-	-	-	-	5	815.021.6	1,7
-	1"	24,3	-	-	-	-	-	5	815.029.6	2,5



Ferrule for non-metallic conduit, nickel plated brass



THREAD ISO	SEALTITE SIZE (INCH)	MIN. INTERNAL BORE (MM)	DIMENSIONS IN MM					STANDARD PACKAGE	ARTICLE NUMBER	WEIGHT (KG/100)
			A	B	C	D	E			
-	1.1/4"	32,7	-	-	-	-	-	2	815.036.6	4,6
-	1.1/2"	37,4	-	-	-	-	-	2	815.042.6	6,8
-	2"	47,9	-	-	-	-	-	2	815.048.6	10,7

# Anaconda Sealbite conduit



## TYPE NMFG BLUE



### ALL-PLASTIC, MEDIUM MECHANICAL STRENGTH, FOOD GRADE CONDUIT

Type NMFG is an all plastic, hygienically designed lightweight flexible conduit that meets the requirements of FDA CFR 21 and NSF / ANSI 51 regulations and EHEDG guidelines. The smooth cover of the conduit is designed to resist microbial accumulation and is easy to clean. The conduit is used to protect cables on processing and packaging machines and equipment in the food and pharmaceutical industries. When used in combination with an Anamet food grade compact fitting an hygienic IP 67 cable protection system with a high pull out strength is achieved.

#### Material & Construction:

**Construction:** Thick smooth thermoplastic (PVC compound) core reinforced with PVC spiral.

**Temperature:** -35 °C to +60 °C, intermittent up to +80 °C.

**Cover specifications:** PVC, lead-free according to RoHS, specially formulated for food and beverage applications per FDA CFR 21 and NSF 51 requirements.

**Colour:** Blue.

#### Classification according to NEN-EN-IEC 61386:

**Compression resistance:** Class 1, Very Light (125 N).

**Impact resistance:** Class 3, Medium (2 J).

**Tensile strength:** Class 4, Heavy (1000 N).

**Protection class:** IP 66 / 67 (dust-proof, water-tight).



Spiral reinforced PVC

All-plastic

SEALTITE	DIAMETRE		BENDING RADIUS		STANDARD CARTON		SMALL CARTON		REELS		WEIGHT (kg/m)
	Size (inch)	Inside (mm)	Outside (mm)	Static (mm)	Dynamic (mm)	Metre	Article No. blue	Metre	Article No. blue	Metre	
3/8"	12,6	17,8	70	100	30	359.012.0	-	-	-	-	0,12
1/2"	16	21,1	100	135	30	359.016.0	-	-	-	-	0,18
3/4"	21,1	26,4	130	175	30	359.020.0	-	-	-	-	0,28
1"	26,8	33,1	180	220	30	359.026.0	-	-	-	-	0,34
1 1/4"	35,4	41,8	225	270	15	359.035.0	-	-	-	-	0,46
1 1/2"	40,3	47,8	255	320	15	359.040.0	-	-	-	-	0,6
2"	51,6	59,9	310	400	15	359.050.0	-	-	-	-	0,8

The fittings for Sealbite NMFG are outlined on page 8 - 14 till 8 - 19  
Sealbite fittings illustrated in chapter 5 can also be used

SEALTITE	1/4"	5/16"	3/8"	1/2"	3/4"	1"	1 1/4"	1 1/2"	2"	2 1/2"	3"	4"
ISO	M10 - M12	M16 - M20	M16 - M20	M20	M25	M32	M40	M50 - M63	M50 - M63	M75	M90	-
Pg	7	9 - 11	11/13,5	16	21	29	36	42	48	-	-	-
NPT	-	-	1/2"	1/2"	3/4"	1"	1 1/4"	1 1/2"	2"	2 1/2"	3"	4"



# Food grade fittings, IP 68, stainless steel AISI-316



## ANACONDA COMPACT HYGIENIC DESIGN, STAINLESS STEEL AISI-316 "FOOD FITTING" FOR ANACONDA SEALTITE

Anaconda compact food grade fittings are hygienically designed and approved according to the guidelines of the European Hygienic Engineering and Design Group (EHEDG). The fittings are constructed of AISI-316 stainless steel, have rounded corners and a smooth profile to minimise the risk of microbial deposits and to promote effective and easy cleaning. The fittings are compact, light and offer excellent resistance to corrosion. When used in combination with a type FG or type NMFG conduit an IP 68 leak-tight cable protection system with a strong pull out strength is achieved.

### Material & Construction:

**Construction:** Stainless steel AISI-316 fitting, consisting of 5 parts (counter nut, upper seal, clamping ring, ferrule and body).

**Material:** Counter nut and body are stainless steel AISI-316 and the ferrule is from nickel plated brass. The blue upper seal and clamping ring are made of TPE in accordance with FDA / CFR 21.

**Special approvals:** Special TPE seals, halogen free, specially formulated for food and beverage

applications per FDA guideline CFR 21. Evaluated and in compliance with the current criteria for Hygienic Equipment Design of the EHEDG (report .DTU CHD DR 2017 8037-088-3).

**Temperature:** -45 °C till +105 °C continuous.

**Protection class:** IP 68 according EN 60529, IP 69 according DIN 40050-9 (till 40 Bar high pressure).

**Colour:** Metal coloured.

ISO straight, compact, food grade fitting, male, stainless steel AISI-316

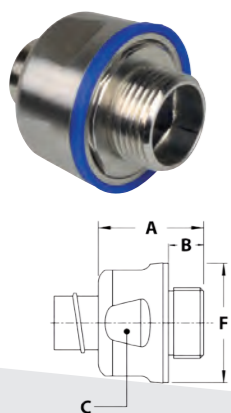

THREAD ISO	SEALTITE SIZE (INCH)	MIN. INTERNAL BORE (MM)	DIMENSIONS IN MM					STANDARD PACKAGE	ARTICLE NUMBER	WEIGHT (KG/100)
			A	B	C	D	F			
M16 x 1,5	3/8"	10,4	29	10	27	-	31	10	742.016.9	5,7
M20 x 1,5	1/2"	13,8	30	10	30	-	34	10	742.020.9	6,9
M25 x 1,5	3/4"	18,5	31	10	36	-	40	5	742.025.9	9,8
M32 x 1,5	1"	23,8	35	12	44	-	48	5	742.032.9	17,2
M40 x 1,5	1.1/4"	31,8	35	13	53	-	57	2	742.040.9	21,7
M50 x 1,5	1.1/2"	36,8	38	14	60	-	65	1	742.050.9	32,6
M63 x 1,5	2"	47,8	40	16	72	-	78	1	742.063.9	44,3

# Food grade fittings, IP 68, stainless steel AISI-316



## ANACONDA HYGIENIC DESIGN, STAINLESS STEEL AISI-316 "FOOD FITTING" FOR ANACONDA SEALTITE

Anaconda food grade fittings are hygienically designed to meet the requirements of the food and pharmaceutical industries. The fittings are constructed of AISI-316 stainless steel, have rounded corners and a smooth profile, a design which minimises the risk of microbial deposits, promotes effective and easy cleaning and resists corrosion. When used in combination with a type FG or NMFG conduit an IP 68 cable protection system with a strong pull out strength is achieved.

### Material & Construction:

**Construction:** Stainless steel AISI-316 fitting, consisting of 6 parts (lower seal, counter nut, upper seal, clamping ring, ferrule and body).

**Material:** Counter nut and body are stainless steel AISI-316 and the ferrule is from nickel plated brass. Clamping ring is from PA6. The blue rubber seals are made of TPE in accordance with FDA / CFR 21.

**Special approvals:** Special TPE seals, halogen free, specially formulated for food and beverage applications per FDA guideline CFR 21.

**Temperature:** -45 °C till +105 °C continuous.

**Protection class:** IP 68 according EN 60529, IP 69 according DIN 40050-9 (till 40 Bar high pressure).

**Colour:** Metal coloured.

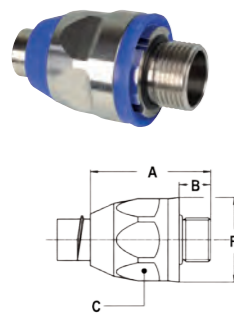

ISO straight food grade fitting, male, stainless steel AISI-316



THREAD ISO	SEALTITE SIZE (INCH)	MIN. INTERNAL BORE (MM)	DIMENSIONS IN MM					STANDARD PACKAGE	ARTICLE NUMBER	WEIGHT (KG/100)
			A	B	C	D	F			
M16 x 1,5	3/8"	10,4	48	12	27	-	31	10	832.016.9	6,6
M20 x 1,5	1/2"	13,8	50	13	30	-	34	10	832.020.9	8
M25 x 1,5	3/4"	18,5	57	15	36	-	41	5	832.025.9	11,8
M32 x 1,5	1"	23,8	68	15	46	-	53	5	832.032.9	22,8
M40 x 1,5	1.1/4"	31,8	75	16	54	-	62	2	832.040.9	34,2
M50 x 1,5	1.1/2"	36,8	81	18	63	-	70	1	832.050.9	38,6
M63 x 1,5	2"	47,8	88	20	77	-	85	1	832.063.9	76,6

All-plastic

# Food grade fittings, IP 67, nickel plated brass



## ANACONDA, MIRROR-POLISHED "ELBOW FOOD FITTING" FOR ANACONDA SEALTITE

Anaconda hygienically designed mirror polished elbow fittings have a very smooth, rounded body which reduces the risk of bacteria formation and promotes effective and easy cleaning in food and pharmaceutical applications. Constructed of nickel plated brass, the fittings offer excellent resistance to corrosion when exposed to water, steam or chemicals. When used in combination with a type FG or type NMFG conduit an IP 67 cable protection system with a strong pull out strength is achieved.

### Material & Construction:

**Construction:** Nickel plated brass fitting, consisting of 4 parts (counter nut, clamping ring, ferrule and body).

**Material:** Counter nut, body and ferrule are nickel plated brass. Clamping ring and inserts are made from PA6 (red for ISO metric).

**Temperature:** -45 °C till +105 °C continuous.

**Protection class:** IP 67 (dust-proof, water-tight).

**Colour:** Metal coloured.

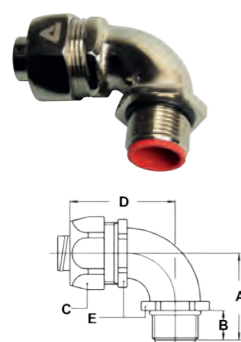

ISO 90° fitting, male, mirror-polished nickel plated brass



THREAD ISO	SEALTITE SIZE (INCH)	MIN. INTERNAL BORE (MM)	DIMENSIONS IN MM					STANDARD PACKAGE	ARTICLE NUMBER	WEIGHT (KG/100)
			A	B	C	D	E			
M16 x 1,5	3/8"	10,2	32	12	26	42	22	10	818.916.0-NM	8,2
M20 x 1,5	3/8"	10,2	33	13	26	42	22	10	818.917.0-NM	8,4
M20 x 1,5	1/2"	13,9	36	13	29	43	27	10	818.920.0-NM	12,6
M25 x 1,5	3/4"	18,5	43	15	35	48	33	5	818.925.0-NM	19,2
M32 x 1,5	1"	23,8	48	15	45	59	42	5	818.932.0-NM	31,6

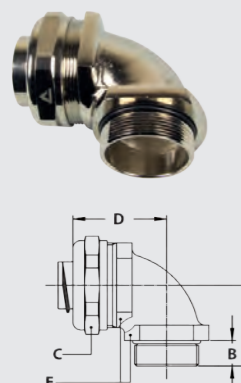

ISO 90° fitting, compact, male, mirror-polished nickel plated brass



THREAD ISO	SEALTITE SIZE (INCH)	MIN. INTERNAL BORE (MM)	DIMENSIONS IN MM					STANDARD PACKAGE	ARTICLE NUMBER	WEIGHT (KG/100)
			A	B	C	D	E			
M40 x 1,5	1.1/4"	33,3	46	13	53	53	52	2	718.940.0-NM	40,1
M50 x 1,5	1.1/2"	38	52	14	62	57	60	2	718.950.0-NM	57,5
M63 x 1,5	2"	49	62	16	76	68	72	2	718.963.0-NM	90,6

# Compact fittings, IP 66 / IP 67, stainless steel AISI-304



## ANACONDA COMPACT FITTINGS, STAINLESS STEEL AISI-304, FOR ANACONDA SEALTITE

Anaconda compact stainless steel AISI-304 fittings are exclusively designed for use with conduit type NMFG. Light in weight and short in length the fittings are easy to install especially in situations where space is limited. The fittings offer excellent resistance to corrosion when exposed to water, steam or aggressive oil or chemicals. When used in combination with a type NMFG conduit an IP 66 / 67 cable protection system with a strong pull out strength is achieved.

### Material & Construction:

**Construction:** Stainless steel AISI-304, consisting of 4 parts (counter nut, clamping ring, ferrule and body).

**Material:** Counter nut and body are stainless steel AISI-304. Clamping ring is made from PA6 and the ferrule is made of nickel plated brass. The O-rings are from NBR rubber (black for ISO).

**Temperature:** -45 °C till +105 °C continuous.

**Protection class:** IP 66 / 67, Nema 4X.

**Colour:** Metal coloured.

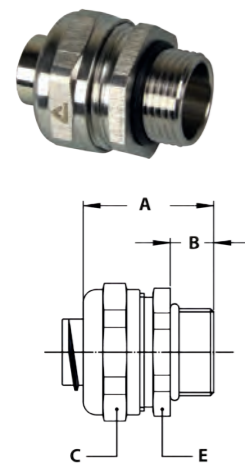

ISO straight fitting, compact, stainless steel AISI-304



THREAD ISO	SEALTITE SIZE (INCH)	MIN. INTERNAL BORE (MM)	DIMENSIONS IN MM					STANDARD PACKAGE	ARTICLE NUMBER	WEIGHT (KG/100)
			A	B	C	D	E			
M16 x 1,5	3/8"	10,6	31	10	26	-	24	10	712.016.9-NM	3,9
M20 x 1,5	3/8"	10,6	31	10	26	-	24	10	712.017.9-NM	4
M20 x 1,5	1/2"	14	32	10	29	-	27	10	712.020.9-NM	4,4
M25 x 1,5	3/4"	19,1	33	10	35	-	33	5	712.025.9-NM	6,6
M32 x 1,5	1"	24,3	36	12	45	-	42	5	712.032.9-NM	11,7
M40 x 1,5	1 1/4"	32,7	40	13	53	-	50	2	712.040.9-NM	16
M50 x 1,5	1 1/2"	37,4	46	14	62	-	58	2	712.050.9-NM	25,3
M63 x 1,5	2"	47,9	52	16	76	-	72	2	712.063.9-NM	38,6

All-plastic

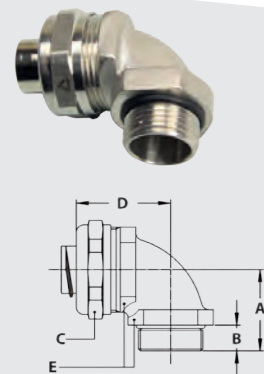

ISO 90° fitting, compact, male, stainless steel AISI-304



THREAD ISO	SEALTITE SIZE (INCH)	MIN. INTERNAL BORE (MM)	DIMENSIONS IN MM					STANDARD PACKAGE	ARTICLE NUMBER	WEIGHT (KG/100)
			A	B	C	D	E			
M16 x 1,5	3/8"	10,6	26	10	26	31	22	10	712.916.9-NM	6,6
M20 x 1,5	3/8"	10,6	26	10	26	32	24	10	712.917.9-NM	7,9
M20 x 1,5	1/2"	14	28	10	29	34	27	10	712.920.9-NM	9,2
M25 x 1,5	3/4"	19,1	32	10	35	40	33	5	712.925.9-NM	16,2
M32 x 1,5	1"	24,3	40	12	45	49	42	5	712.932.9-NM	27,8
M40 x 1,5	1 1/4"	32,7	46	13	53	53	52	2	712.940.9-NM	40,1
M50 x 1,5	1 1/2"	37,4	52	14	62	57	60	2	712.950.9-NM	57,5
M63 x 1,5	2"	47,9	62	16	76	68	72	2	712.963.9-NM	90,6

# Compact fittings, IP 66 / IP 67, stainless steel AISI-316



## ANACONDA COMPACT FITTINGS, STAINLESS STEEL AISI-316, FOR ANACONDA SEALTITE NMFG

Anaconda compact stainless steel AISI-316 fittings are exclusively designed for use with conduit type NMFG. Light in weight and short in length the fittings are easy to install especially in situations where space is limited. The fittings offer excellent resistance to corrosion when exposed to water, steam or aggressive oil or chemicals. When used in combination with a type NMFG conduit an IP 66 / 67 cable protection system with a strong pull out strength is achieved.

### Material & Construction:

**Construction:** Stainless steel AISI-316, consisting of 4 parts (counter nut, clamping ring, ferrule and body).

**Material:** Counter nut and body are stainless steel AISI-316 whereas the ferrule is nickel plated brass. Clamping ring is made from PA6. The O-rings are from NBR rubber.

**Temperature:** -45 °C till +105 °C continuous.

**Protection class:** IP 66 / IP 67, Nema 4X.

**Colour:** Metal coloured.

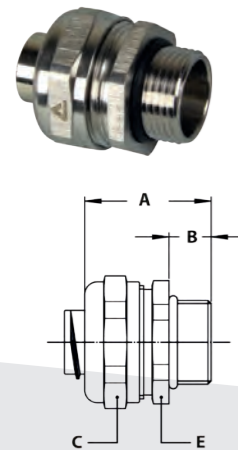

ISO straight fitting, compact, stainless steel AISI-316



THREAD ISO	SEALTITE SIZE (INCH)	MIN. INTERNAL BORE (MM)	DIMENSIONS IN MM					STANDARD PACKAGE	ARTICLE NUMBER	WEIGHT (KG/100)
			A	B	C	D	E			
M16 x 1,5	3/8"	10,6	31	10	26	-	24	10	712.116.9-NM	3,9
M20 x 1,5	3/8"	10,6	31	10	26	-	24	10	712.117.9-NM	4
M20 x 1,5	1/2"	14	32	10	29	-	27	10	712.120.9-NM	4,4
M25 x 1,5	3/4"	19,1	33	10	35	-	33	5	712.125.9-NM	6,6
M32 x 1,5	1"	24,3	36	12	45	-	42	5	712.132.9-NM	11,7
M40 x 1,5	1.1/4"	32,7	40	13	53	-	50	2	712.140.9-NM	16
M50 x 1,5	1.1/2"	37,4	46	14	62	-	58	2	712.150.9-NM	25,3
M63 x 1,5	2"	47,9	52	16	76	-	72	2	712.163.9-NM	38,6

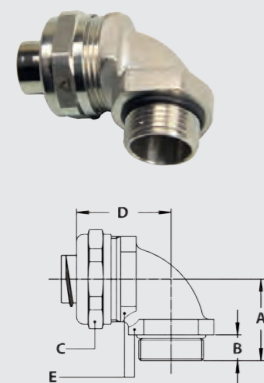

ISO 90° fitting, compact, male, stainless steel AISI-316



THREAD ISO	SEALTITE SIZE (INCH)	MIN. INTERNAL BORE (MM)	DIMENSIONS IN MM					STANDARD PACKAGE	ARTICLE NUMBER	WEIGHT (KG/100)
			A	B	C	D	E			
M16 x 1,5	3/8"	10,6	26	10	26	31	22	10	712.516.9-NM	6,6
M20 x 1,5	3/8"	10,6	26	10	26	32	24	10	712.517.9-NM	7,9
M20 x 1,5	1/2"	14	28	10	29	34	27	10	712.520.9-NM	9,2
M25 x 1,5	3/4"	19,1	32	10	35	40	33	5	712.525.9-NM	16,2
M32 x 1,5	1"	24,3	40	12	45	49	42	5	712.532.9-NM	27,8
M40 x 1,5	1.1/4"	32,7	46	13	53	53	52	2	712.540.9-NM	40,1
M50 x 1,5	1.1/2"	37,4	52	14	62	57	60	2	712.550.9-NM	57,5
M63 x 1,5	2"	47,9	62	16	76	68	72	2	712.563.9-NM	90,6

## ACCESSORIES, STAINLESS STEEL

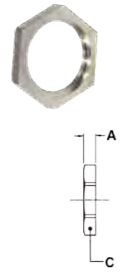

ISO lock nuts, stainless steel AISI-304



THREAD	SEALTITE SIZE (INCH)	MIN. INTERNAL BORE (MM)	DIMENSIONS IN MM					STANDARD PACKAGE	ARTICLE NUMBER	WEIGHT (KG/100)
			A	B	C	D	E			
M16 x 1,5	-	-	3,2	-	20	-	-	50	880.116.9	0,5
M20 x 1,5	-	-	3,6	-	24	-	-	50	880.120.9	0,7
M25 x 1,5	-	-	3,6	-	29	-	-	25	880.125.9	1,1
M32 x 1,5	-	-	4,6	-	35	-	-	25	880.132.9	2,4
M40 x 1,5	-	-	5	-	46	-	-	5	880.140.9	3,6
M50 x 1,5	-	-	5	-	60	-	-	5	880.150.9	5,4
M63 x 1,5	-	-	6	-	70	-	-	5	880.163.9	6,2

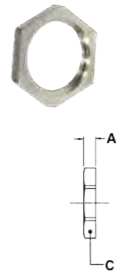

ISO locknut, stainless steel AISI-316



THREAD	SEALTITE SIZE (INCH)	MIN. INTERNAL BORE (MM)	DIMENSIONS IN MM					STANDARD PACKAGE	ARTICLE NUMBER	WEIGHT (KG/100)
			A	B	C	D	E			
M16 x 1,5	-	-	3,2	-	20	-	-	50	880.116.8	0,5
M20 x 1,5	-	-	3,6	-	24	-	-	50	880.120.8	0,7
M25 x 1,5	-	-	3,6	-	29	-	-	25	880.125.8	1,1
M32 x 1,5	-	-	4,6	-	35	-	-	25	880.132.8	2,4
M40 x 1,5	-	-	5	-	46	-	-	5	880.140.8	3,6
M50 x 1,5	-	-	5	-	60	-	-	5	880.150.8	5,4
M63 x 1,5	-	-	6	-	70	-	-	5	880.163.8	6,2



Ferrule for non-metallic conduit, nickel plated brass



THREAD ISO	NMFG SIZE (INCH)	MIN. INTERNAL BORE (MM)	DIMENSIONS IN MM					STANDARD PACKAGE	ARTICLE NUMBER	WEIGHT (KG/100)
A	B	C	D	E						
-	3/8"	10,6	-	-	-	-	-	10	815.011.6	0,8
-	1/2"	14	-	-	-	-	-	10	815.016.6	1,1
-	3/4"	19,1	-	-	-	-	-	5	815.021.6	1,7
-	1"	24,3	-	-	-	-	-	5	815.029.6	2,5

All-plastic



Ferrule for non-metallic conduit, nickel plated brass



THREAD ISO	NMFG SIZE (INCH)	MIN. INTERNAL BORE (MM)	DIMENSIONS IN MM					STANDARD PACKAGE	ARTICLE NUMBER	WEIGHT (KG/100)
A	B	C	D	E						
-	1,1/4"	32,7	-	-	-	-	-	2	815.036.6	4,6
-	1,1/2"	37,4	-	-	-	-	-	2	815.042.6	6,8
-	2"	47,9	-	-	-	-	-	2	815.048.6	10,7



# Anamet Spiral conduit

## TYPE MPC GREY



### LIGHT TO NORMAL MECHANICAL STRENGTH, EXTREMELY FLEXIBLE

Type MPC is a very flexible, lightweight, plastic coated metal spiral conduit with a convoluted cover which is designed for applications with a low bending radius requirement. Type MPC is typically used in static applications to protect cables on light machinery and equipment in situations where space is limited. The conduit provides good resistance to chemicals. When type MPC is used in combination with Anamet fittings an IP 67 cable protection system with a strong pull out strength is achieved.

#### Material & Construction:

**Construction:** Plastic coated metal spiral with thin wall convoluted thermoplastic (PVC compound) cover.

**Cover specifications:** PVC, lead-free according to RoHS.

**Resistant against:** Chemicals, bases and acids.

**Temperature:** -20 °C till +70 °C, intermittent up to +80 °C.

**Colour:** Grey.

#### Classification according to NEN-EN-IEC 61386:

**Compression resistance:** Class 3, Medium (750 N).

**Impact resistance:** Class 3, Medium (2 J).

**Tensile strength:** Class 1, Very light (100 N).

**Protection class:** IP 67 (dust-proof, water-tight).



Spiral reinforced PVC

MPC	DIAMETRE		BENDING RADIUS		STANDARD CARTON		SMALL CARTON		REELS		WEIGHT (kg/m)
	Size (dn)	Inside (mm)	Outside (mm)	Static (mm)	Dynamic (mm)	Metre	Article No. grey	Metre	Article No. grey	Metre	
9	10	14	14	40	50	620.309.0	10	620.309.1	-	-	0,08
11	13	17	17	48	50	620.311.0	10	620.311.1	-	-	0,12
13	15	19	19	55	50	620.313.0	10	620.313.1	-	-	0,13
16	16	21	21	60	50	620.316.0	10	620.316.1	-	-	0,14
21	21	27	27	75	50	620.321.0	10	620.321.1	-	-	0,26
29	30	36	36	100	25	620.329.0	10	620.329.1	-	-	0,35
36	38	45	45	124	25	620.336.0	10	620.336.1	-	-	0,54
42	44	52	52	143	25	620.342.0	10	620.342.1	-	-	0,67
48	48	56	56	154	25	620.348.0	10	620.348.1	-	-	0,7

The fittings for Anamet MPC are outlined on page 8 - 22 till 8 - 24

MPC / MPU	-	9	11	13	16	21	29	36	42	48
ISO	-	M16	M20	-	M25	M32	M40	M50	-	M63
Pg	-	9	11	13,5	16	21	29	36	42	48
NPT	-	-	-	-	-	-	-	-	-	-

# Anamet Spiral conduit

## TYPE MPU BLUE



### LIGHT TO NORMAL MECHANICAL STRENGTH, EXTREMELY FLEXIBLE, CHEMICAL RESISTANT

Type MPU is a very flexible, polyurethane coated metal spiral conduit with a convoluted cover which is designed for use in applications with a low bending radius requirement. Type MPU is typically used in static applications to protect cables on light machinery and equipment, cabinets and installations in, amongst others, the transport industry. When type MPU is used in combination with Anamet fittings an IP 67 cable protection system with a strong pull out strength is achieved.

#### Material & Construction:

**Construction:** Plastic coated metal spiral with thin wall convoluted thermoplastic (TPU compound) cover.

**Cover specifications:** Polyurethane, halogen free, lead-free according to RoHS.

**Resistant against:** Chemicals, mineral oils and greases.

**Temperature:** -40 °C till +90 °C, intermittent up to +125 °C.

**Colour:** Blue.

#### Classification according to NEN-EN-IEC 61386:

**Compression resistance:** Class 3, Medium (750 N).

**Impact resistance:** Class 3, Medium (2 J).

**Tensile strength:** Class 1, Very light (100 N).

**Protection class:** IP 67 (dust-proof, water-tight).



Spiral reinforced PVC

All-plastic

MPU	DIAMETRE		BENDING RADIUS		STANDARD CARTON		SMALL CARTON		REELS		WEIGHT (kg/m)
	Size (dn)	Inside (mm)	Outside (mm)	Static (mm)	Dynamic (mm)	Metre	Article No. blue	Metre	Article No. blue	Metre	
9	10	14	14	40	50	620.409.0	10	620.409.1	-	-	0,08
11	13	17	17	48	50	620.411.0	10	620.411.1	-	-	0,12
13	15	19	19	55	50	620.413.0	10	620.413.1	-	-	0,13
16	16	21	21	60	50	620.416.0	10	620.416.1	-	-	0,14
21	21	27	27	75	50	620.421.0	10	620.421.1	-	-	0,26
29	30	36	36	100	25	620.429.0	10	620.429.1	-	-	0,35
36	38	45	45	124	25	620.436.0	10	620.436.1	-	-	0,54
42	44	52	52	143	25	620.442.0	10	620.442.1	-	-	0,67
48	48	56	56	154	25	620.448.0	10	620.448.1	-	-	0,7

The fittings for Anamet MPU are outlined on page 8 - 22 till 8 - 24

MPC / MPU	-	9	11	13	16	21	29	36	42	48
ISO	-	M16	M20	-	M25	M32	M40	M50	-	M63
Pg	-	9	11	13,5	16	21	29	36	42	48
NPT	-	-	-	-	-	-	-	-	-	-

# Plastic fittings, IP 54, for MPC / MPU, PP



## ANAMET PLASTIC FITTINGS FOR ANAMET PLASTIC CONDUIT MPC / MPU

These Anamet plastic fittings are exclusively designed for use with type MPC and type MPU conduits. These fittings are lightweight, easy to install and when combined with a type MPC or type MPU conduit an IP 67 cable protection system with a strong pull out strength is achieved.

### Material & Construction:

**Construction:** One piece swivel fitting with integrated ferrule.

**Material:** PP (Polypropylene).

**Temperature:** -10 °C till +110 °C continuous.

**Protection class:** IP 54.

**Colour:** Grey.



ISO straight fitting, male swivel, plastic (PP)



THREAD ISO	MPC / MPU SIZE (DN)	MIN. INTERNAL BORE (MM)	DIMENSIONS IN MM					STANDARD PACKAGE	ARTICLE NUMBER	WEIGHT (KG/100)
			A	B	C	D	E			
M16 x 1,5	9	8,8	44	9	20	-	-	50	651.316.2	0,7
M20 x 1,5	11	11,1	48	9	24	-	-	50	651.320.2	0,9
M25 x 1,5	16	14,8	52	10	30	-	-	50	651.325.2	1,5
M32 x 1,5	21	19,4	55	11	36	-	-	25	651.332.2	2,1
M40 x 1,5	29	27,9	58	12	46	-	-	25	651.340.2	3,4
M50 x 1,5	36	35,6	61	13	55	-	-	25	651.350.2	4,9
M63 x 1,5	48	45,9	63	14	65	-	-	10	651.363.2	7



Pg straight fitting, male swivel, plastic (PP)



THREAD PG	MPC / MPU SIZE (DN)	MIN. INTERNAL BORE (MM)	DIMENSIONS IN MM					STANDARD PACKAGE	ARTICLE NUMBER	WEIGHT (KG/100)
			A	B	C	D	E			
Pg 9	9	8,8	44	9	20	-	-	50	650.509.2	0,7
Pg 11	11	11,1	48	9	24	-	-	50	650.511.2	0,9
Pg 13,5	13	13	50	10	27	-	-	50	650.513.2	1,2
Pg 16	16	14,8	52	10	30	-	-	50	650.516.2	1,5
Pg 21	21	19,4	55	11	36	-	-	25	650.521.2	2,1
Pg 29	29	27,9	58	12	46	-	-	25	650.529.2	3,4
Pg 36	36	35,6	61	13	55	-	-	25	650.536.2	4,9
Pg 42	42	41,9	62	13	62	-	-	25	650.542.2	6,1
Pg 48	48	45,9	63	14	65	-	-	10	650.548.2	7



Box bracket fitting, swivel, plastic (PP)



THREAD	MPC / MPU SIZE (DN)	MIN. INTERNAL BORE (MM)	DIMENSIONS IN MM					STANDARD PACKAGE	ARTICLE NUMBER	WEIGHT (KG/100)
			A	B	C	D	E			
-	9	8,8	44	6	29	12,5	-	50	650.609.3	0,8
-	11	11,1	48	6	37	13	-	50	650.611.3	1
-	13	13	50	6	37	14	-	50	650.613.3	1,3
-	16	14,8	52	6	37	15,5	-	50	650.616.3	1,6
-	21	19,4	55	6	43	16,5	-	25	650.621.3	2,1
-	29	27,9	58	7	53	17	-	25	650.629.3	3,3

# Plastic fittings, IP 67, for MPC / MPU, polyamide



## ANAMET PLASTIC FITTINGS FOR ANAMET PLASTIC CONDUIT MPC AND MPU

These plastic Anamet fittings are specially made for the combination with Anamet MPC and MPU. The fitting offers a high degree (IP 67) of protection. These fittings are mostly used in cabinet building and industrial installations.

### Material & Construction:

**Construction:** Plastic fitting, consisting of 4 parts (counter nut, clamping sleeve, ferrule and body).

**Material:** Counter nut, ferrule and body are Polyamide PA6, clamping sleeve is from TPE.

**Temperature:** -35 °C till +80 °C continuous.

**Protection class:** IP 67 (dust-proof, water-tight).

**Colour:** Grey.



ISO straight fitting, male, plastic (PA6)



THREAD ISO	MPC / MPU SIZE (DN)	MIN. INTERNAL BORE (MM)	DIMENSIONS IN MM					STANDARD PACKAGE	ARTICLE NUMBER	WEIGHT (KG/100)
			A	B	C	D	E			
M16 x 1,5	9	10	36	10	23	-	-	50	651.716.2	10
M20 x 1,5	11	13,5	37	10	27	-	-	50	651.717.2	13,5
M20 x 1,5	13	15	38	10	29	-	-	50	651.720.2	15
M25 x 1,5	16	16,5	41	11	32	-	-	50	651.725.2	16,5
M32 x 1,5	21	22	45	11	39	-	-	25	651.732.2	22
M40 x 1,5	29	31	49	12	49	-	-	25	651.740.2	31
M50 x 1,5	36	39,5	55	13	58	-	-	25	651.750.2	39,5
M63 x 1,5	48	50	61	15	70	-	-	10	651.763.2	50

All-plastic

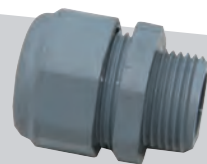

Pg straight fitting, male, plastic (PA6)



THREAD PG	MPC / MPU SIZE (DN)	MIN. INTERNAL BORE (MM)	DIMENSIONS IN MM					STANDARD PACKAGE	ARTICLE NUMBER	WEIGHT (KG/100)
			A	B	C	D	E			
Pg 9	9	10	36	10	23	-	-	50	650.709.2	10
Pg 11	11	13,5	37	10	27	-	-	50	650.711.2	13,5
Pg 13,5	13	15	38	10	29	-	-	50	650.713.2	15
Pg 16	16	16,5	41	11	32	-	-	50	650.716.2	16,5
Pg 21	21	22	45	11	39	-	-	25	650.721.2	22
Pg 29	29	31	49	12	49	-	-	25	650.729.2	31
Pg 36	36	39,5	55	13	58	-	-	25	650.736.2	39,5
Pg 42	42	44	57	13	65	-	-	10	650.742.2	44
Pg 48	48	50	61	15	70	-	-	10	650.748.2	50

# Fittings for MPC / MPU, IP 67, nickel plated brass



## ANAMET NICKEL PLATED BRASS FITTINGS FOR ANAMET CONDUIT MPC AND MPU

These Anamet nickel plated brass fittings are exclusively designed for use with type MPC and type MPU conduits. When used in combination with Anamet type MPC and MPU an IP 67 cable protection system with a strong pull out strength is achieved.

### Material & Construction:

**Construction:** Nickel plated brass fitting, consisting of 4 parts (counter nut, clamping sleeve, ferrule and body).

**Material:** Counter nut and body are nickel plated brass, ferrule is from brass and clamping sleeve is from TPE.

**Temperature:** -10 °C till +110 °C continuous.

**Protection class:** IP 67 (dust-proof, water-tight).

**Colour:** Metal coloured.



ISO straight fitting, male, nickel plated brass



THREAD ISO	MPC / MPU SIZE (DN)	MIN. INTERNAL BORE (MM)	DIMENSIONS IN MM					STANDARD PACKAGE	ARTICLE NUMBER	WEIGHT (KG/100)
			A	B	C	D	E			
M12 x 1,5	9	8,3	35	10	22	-	-	50	651.812.4	2,2
M16 x 1,5	11	12,2	37	10	25	-	-	50	651.816.4	3,7
M20 x 1,5	13	15	38	10	27	-	-	50	651.817.4	3,9
M20 x 1,5	16	16	40	11	29	-	-	50	651.820.4	5,1
M25 x 1,5	21	20,8	42	11	36	-	-	25	651.825.4	8,6
M32 x 1,5	29	27,5	45	12	46	-	-	25	651.832.4	14,3
M40 x 1,5	36	35,5	48	13	55	-	-	25	651.840.4	21,3
M50 x 1,5	42	44	50	13	63	-	-	10	651.850.4	28,5
M50 x 1,5	48	45,5	55	14	67	-	-	10	651.855.4	33,8



Pg straight fitting, male, nickel plated brass



THREAD PG	MPC / MPU SIZE (DN)	MIN. INTERNAL BORE (MM)	DIMENSIONS IN MM					STANDARD PACKAGE	ARTICLE NUMBER	WEIGHT (KG/100)
			A	B	C	D	E			
Pg 9	9	8,3	35	10	22	-	-	50	650.809.4	2,2
Pg 11	11	12,2	37	10	25	-	-	50	650.811.4	3,7
Pg 13,5	13	15	38	10	27	-	-	50	650.813.4	3,9
Pg 16	16	16	40	11	29	-	-	50	650.816.4	5,1
Pg 21	21	20,8	42	11	36	-	-	25	650.821.4	8,6
Pg 29	29	27,5	45	12	46	-	-	25	650.829.4	14,3
Pg 36	36	35,5	48	13	55	-	-	25	650.836.4	21,3
Pg 42	42	44	50	13	63	-	-	10	650.842.4	28,5
Pg 48	48	45,5	55	14	67	-	-	10	650.848.4	33,8



















# Ana-Quick Profi

Ana-Quick  
Profi



# Overview table Ana-Quick Profi

ANA-QUICK	MATERIAL	MATERIAL	TEMPERATURE		RESISTANCE (NEN-EN-IEC 61386)			FLEXI- BILITY	RESISTANCE		APPROVALS	PROTEC- TION	PAGE
			Cover	Min.	Max.	Compr.	Impact		Tensile	UV			
Type	Innercore	Cover	Min.	Max.	Compr.	Impact	Tensile		UV	Oil		Class	
<b>PA6L Black</b>	Polyamide PA6 Halogen free	-	-40 °C	+120 °C	1 (125N)	1 (0,5J)	1 (100N)	++++	++++	++++	UL-94 HB 	IP 67	9 - 3
<b>PA6S Black</b>	Polyamide PA6 Halogen free	-	-40 °C	+120 °C	2 (320N)	2 (1J)	2 (250N)	++++	++++	++++	UL-94 HB 	IP 67	9 - 4
<b>PA6S Grey</b>	Polyamide PA6 Halogen free	-	-40 °C	+120 °C	2 (320N)	2 (1J)	2 (250N)	++++	+++	++++	UL-94 HB 	IP 67	9 - 5
<b>PA6SU Black</b>	Polyamide PA6 Halogen free	-	-40 °C	+120 °C	2 (320N)	2 (1J)	2 (250N)	++++	++++	++++	UL-94 HB 	IP 67	9 - 6
<b>PA6V0 Black</b>	Polyamide PA6 Halogen free	-	-40 °C	+120 °C	3 (750N)	3 (2J)	3 (500N)	++++	++++	++++	UL-94 V0   	IP 67	9 - 7
<b>PA12S Black</b>	Polyamide PA12 Halogen free	-	-40 °C	+120 °C	2 (320N)	2 (1J)	2 (250N)	++++	++++	++++	UL-94 HB 	IP 67	9 - 8
<b>PP-Mod Black</b>	Polypropylene PP-Mod	-	-40 °C	+135 °C	1 (125N)	1 (0,5J)	1 (100N)	++++	++++	++++	UL-94 V2 	IP 67	9 - 9
<b>PA6S DUO</b>	Polyamide PA6 Halogen free	-	-40 °C	+120 °C	3 (750N)	3 (2J)	3 (500N)	++++	++++	++++	UL-94 HB 	IP 54	9 - 10
<b>PP-Mod DUO</b>	Polypropylene PP-Mod	-	-40 °C	+135 °C	2 (320N)	2 (1J)	2 (250N)	++++	++	++++	UL-94 V2 	IP 54	9 - 11
<b>PP-UV DUO</b>	Polypropylene PP-Mod	-	-40 °C	+135 °C	2 (320N)	2 (1J)	2 (250N)	++++	++++	++++	UL-94 V2 	IP 54	9 - 12
<b>GIG PA6 Black</b>	Polyamide PA6 Halogen free	-	-40 °C	+120 °C	2 (320N)	2 (1J)	2 (250N)	+++	++++	++++	UL-94 HB 	IP 67	9 - 26
<b>GIG PA6 Grey</b>	Polyamide PA6 Halogen free	-	-40 °C	+120 °C	2 (320N)	2 (1J)	2 (250N)	+++	++++	++++	UL-94 HB 	IP 67	9 - 26
<b>GIG PP Black</b>	Polypropylene PP-Mod	-	-40 °C	+135 °C	1 (125N)	1 (0,5J)	1 (100N)	++++	++++	++++	UL-94 V2 	IP 67	9 - 27
<b>GIG PUR Black</b>	Polyurethane TPU Halogen free	-	-40 °C	+125 °C	1 (125N)	1 (0,5J)	1 (100N)	++++	++++	++++	UL-94 HB 	IP 67	9 - 28

# Ana-Quick polyamide conduit

## PA6L BLACK



### LIGHT MODEL, FOR LIGHT AND MEDIUM MECHANICAL STRENGTH

The PA6L is applicable for standard circumstances and for frequent movements. The PA6L is used in light machines and installations in the machine- and equipment-building and in the transportation area.

#### Material & Construction:

**Construction:** Corrugated conduit from modified polyamide PA6, UV resistant, halogen free.

**Temperature:** -40 °C till +120 °C, intermittent up to +150 °C.

**Flame properties:** Flame-retarding UL-94 HB.

**Colour:** Black.

**Resistant against:** Alcohol, grease, fuels, mineral oils, weak bases and weak acids.

#### Classification according to NEN-EN-IEC 61386:

**Compression resistance:** Class 1, Very Light (125 N).

**Impact resistance:** Class 1, Very Light (0,5 J).

**Tensile strength:** Class 1, Very Light (100 N).

**Protection class:** IP 67 (dust-proof, water-tight).



Normal profile "standard wall"

ANA-QUICK	DIAMETRE		BENDING RADIUS [CL]		STANDARD CARTON		SMALL CARTON		REEL		WEIGHT
	Size (dn)	Inside (mm)	Outside (mm)	Static (mm)	Dynamic (mm)	Metre	Article No. black	Metre	Article No. black	Metre	
7,5	6,7	10,0	11	33	50	801.107.0	-	-	5000	801.107.5	0,015
10	10,1	13,2	18	54	50	801.110.0	-	-	3000	801.110.5	0,020
12	12,5	15,7	26	78	50	801.112.0	-	-	2200	801.112.5	0,025
17	17,0	21,2	40	120	50	801.117.0	-	-	1100	801.117.5	0,044
23	23,5	28,4	50	150	50	801.123.0	-	-	650	801.123.5	0,064
29	29,4	34,5	60	180	25	801.129.0	-	-	450	801.129.5	0,087
37	36,7	42,2	80	240	25	801.136.0	-	-	250	801.136.5	0,121
50	48,1	54,0	90	270	25	801.148.0	-	-	150	801.148.5	0,158

\* Also available in slitted execution (article number 801.xxx.7 for standard cartons).

Ana-Quick  
Profi

The fittings for Ana-Quick Profi are outlined in this chapter on pages 9 - 12 till 9 - 25

ANA-QUICK	7,5	10	12	17	23	29	37	50
ISO	M12	M12 - M16	M16 - M20	M20 - M25	M25	M32	M40	M50 - M63
PG	7	7 - 9 - 11	11 - 13,5	13,5 - 16	21	29	36	48
NPT	-	-	-	-	-	-	-	-

# Ana-Quick polyamide conduit

## PA6S BLACK



### STANDARD MODEL, FOR MEDIUM AND HIGH MECHANICAL STRENGTH

The PA6S is applicable for standard circumstances and for frequent movements. The PA6S is used in medium and heavy machines, in hospital-building, packaging-machines and the transportation area.

#### Material & Construction:

**Construction:** Corrugated conduit from modified polyamide PA6, UV resistant, halogen free.

**Temperature:** -40 °C till +120 °C, intermittent up to +150 °C.

**Flame properties:** Flame-retarding UL-94 HB.

**Colour:** Black (grey is also available).

**Resistant against:** Alcohol, grease, fuels, mineral oils, weak bases and weak acids.

#### Classification according to NEN-EN-IEC 61386:

**Compression resistance:** Class 2, Light (320 N).

**Impact resistance:** Class 2, Light (1 J).

**Tensile strength:** Class 2, Light (250 N).

**Protection class:** IP 67 (dust-proof, water-tight).



Normal profile "standard wall"

ANA-QUICK	DIAMETRE		BENDING RADIUS (CL)		STANDARD CARTON		SMALL CARTON		REEL		WEIGHT (kg/m)
	Size (dn)	Inside (mm)	Outside (mm)	Static (mm)	Dynamic (mm)	Metre	Article No. black	Metre	Article No. black	Metre	
4,5	5	7,1	10	28	100	801.305.0	-	-	9000	801.305.5	0,009
7,5	6,7	10	13	39	50	801.307.0	-	-	5000	801.307.5	0,018
10	9,9	13	20	60	50	801.310.0	-	-	3000	801.310.5	0,024
12	12,2	15,7	30	90	50	801.312.0	-	-	2200	801.312.5	0,033
17	16,6	21,2	45	135	50	801.317.0	-	-	1100	801.317.5	0,056
23	23,2	28,9	55	165	50	801.323.0	-	-	650	801.323.5	0,09
29	29	34,5	65	195	25	801.329.0	-	-	450	801.329.5	0,122
37	36	42,4	90	270	25	801.336.0	-	-	250	801.336.5	0,166
50	47,7	54	100	300	25	801.348.0	-	-	150	801.348.5	0,225

The fittings for Ana-Quick Profi are outlined in this chapter on pages 9 - 13 till 9 - 25

ANA-QUICK	7,5	10	12	17	23	29	37	50
ISO	M12	M12 - M16	M16 - M20	M20 - M25	M25	M32	M40	M50 - M63
PG	7	7 - 9 - 11	11 - 13,5	13,5 - 16	21	29	36	48
NPT	-	-	-	-	-	-	-	-

# Ana-Quick polyamide conduit

## PA6S GREY



### STANDARD MODEL, FOR MEDIUM AND HEAVY MECHANICAL STRENGTH

The PA6S is applicable for standard circumstances and for frequent movements. The PA6S is used in medium and heavy machines, in hospital-building, packaging-machines and the transportation area.

#### Material & Construction:

**Construction:** Corrugated conduit from modified polyamide PA6, UV resistant, halogen free.

**Temperature:** -40 °C till +120 °C, intermittent up to +150 °C.

**Flame properties:** Flame-retarding UL-94 HB.

**Colour:** Grey (black is also available).

**Resistant against:** Alcohol, grease, fuels, mineral oils, weak bases and weak acids.

#### Classification according to NEN-EN-IEC 61386:

**Compression resistance:** Class 2, Light (320 N).

**Impact resistance:** Class 2, Light (1 J).

**Tensile strength:** Class 2, Light (250 N).

**Protection class:** IP 67 (dust-proof, water-tight).



Normal profile "standard wall"

ANA-QUICK	DIAMETRE		BENDING RADIUS		STANDARD CARTON		SMALL CARTON		REELS		WEIGHT
	Size (dn)	Inside (mm)	Outside (mm)	Static (mm)	Dynamic (mm)	Metre	Article No. grey	Metre	Article No. grey	Metre	
7,5	6,7	10	13	39	50	801.207.0	-	-	5000	801.207.5	0,018
10	9,9	13	20	60	50	801.210.0	-	-	3000	801.210.5	0,024
12	12,2	15,7	30	90	50	801.212.0	-	-	2200	801.212.5	0,033
17	16,6	21,2	45	135	50	801.217.0	-	-	1100	801.217.5	0,056
23	23,2	28,9	55	165	50	801.223.0	-	-	650	801.223.5	0,09
29	29	34,5	65	195	25	801.229.0	-	-	450	801.229.5	0,122
37	36	42,4	90	270	25	801.236.0	-	-	250	801.236.5	0,166
50	47,7	54	100	300	25	801.248.0	-	-	150	801.248.5	0,225

Ana-Quick  
Profi

The fittings for Ana-Quick Profi are outlined in this chapter on pages 9 - 13 till 9 - 25

ANA-QUICK	7,5	10	12	17	23	29	37	50
ISO	M12	M12 - M16	M16 - M20	M20 - M25	M25	M32	M40	M50 - M63
PG	7	7 - 9 - 11	11 - 13,5	13,5 - 16	21	29	36	48
NPT	-	-	-	-	-	-	-	-

# Ana-Quick polyamide conduit

## PA6SU BLACK



### SPECIAL MODEL, FOR HIGH MECHANICAL STRENGTH AND FREQUENT MOVEMENTS

The PA6SU is applicable for heavy circumstances and for frequent movements. The profile of the PA6SU has specially been designed to reduce the abrasion on cables and wires during frequent movement. The PA6SU can be used in combination with the complete range of Ana-Quick Profi fittings. The PA6SU is used in machines and installations where excellent dynamic properties are required.

#### Material & Construction:

**Construction:** Corrugated conduit from modified polyamide PA6, UV resistant, halogen free.  
**Temperature:** -40 °C till +120 °C, intermittent up to +150 °C.  
**Flame properties:** Flame-retarding UL-94 HB.  
**Colour:** Black.  
**Resistant against:** Alcohol, grease, fuels, mineral oils, weak bases and weak acids.

#### Classification according to NEN-EN-IEC 61386:

**Compression resistance:** Class 2, Light (320 N).  
**Impact resistance:** Class 2, Light (1 J).  
**Tensile strength:** Class 2, Light (250 N).  
**Protection class:** IP 67 (dust-proof, water-tight).



UFW profile "standard wall"

ANA-QUICK	DIAMETRE		BENDING RADIUS (CL)		STANDARD CARTON		SMALL CARTON		REEL		WEIGHT (kg/m)	
	Size (dn)	Inside (mm)	Outside (mm)	Static (mm)	Dynamic (mm)	Metre	Article No. black	Metre	Article No. black	Metre		Article No. black
	7,5	6,3	10,1	13	39	50	801.507.0	-	-	5000	801.507.5	0,018
	10	9,3	13,1	20	60	50	801.510.0	-	-	3000	801.510.5	0,025
	12	12	15,9	30	90	50	801.512.0	-	-	2200	801.512.5	0,037
	17	16	21,2	45	135	50	801.517.0	-	-	1100	801.517.5	0,056
	23	22,2	28,6	55	165	50	801.523.0	-	-	650	801.523.5	0,09
	29	28,4	34,6	65	195	25	801.529.0	-	-	450	801.529.5	0,122
	37	35,4	42,3	90	270	25	801.536.0	-	-	250	801.536.5	0,172

The fittings for Ana-Quick Profi are outlined in this chapter on pages 9 - 13 till 9 - 25

ANA-QUICK	7,5	10	12	17	23	29	37	50
ISO	M12	M12 - M16	M16 - M20	M20 - M25	M25	M32	M40	M50 - M63
PG	7	7 - 9 - 11	11 - 13,5	13,5 - 16	21	29	36	48
NPT	-	-	-	-	-	-	-	-

# Ana-Quick polyamide conduit

## PA6VO BLACK



### ROBUST MODEL FOR HIGH MECHANICAL STRENGTH AND GOOD FLAME-PROPERTIES

Type PA6VO is an extra heavy polyamide conduit for high mechanical strength. The PA6VO is applicable for heavy circumstances and for frequent movements. The PA6VO is used in heavy machinery. Due to the good flame properties, the PA6VO is particularly suitable for train-building and public areas.

#### Material & Construction:

**Construction:** Corrugated conduit from modified polyamide PA6, UV resistant, halogen free.

**Flame properties:** Self-extinguishing UL-94 V0.

**Special approvals, flame properties according to:**

- EN 45545-2 (2013):
- R22 (interior equipment) class HL1 and HL2
- R23 (exterior equipment) class HL1, HL2 and HL3.

**Resistant against:** Alcohol, grease, fuels, mineral oils, weak bases and weak acids.

**Temperature:** -40 °C till +120 °C, intermittent up to +150 °C.

**Colour:** Black.

#### Classification according to NEN-EN-IEC 61386:

**Compression resistance:** Class 3, Medium (750 N).

**Impact resistance:** Class 3, Medium (2 J).

**Tensile strength:** Class 3, Medium (500 N).

**Protection class:** IP 67 (dust-proof, water-tight).



Normal profile "thick wall"

ANA-QUICK	DIAMETRE		BENDING RADIUS (CL)		STANDARD CARTON		SMALL CARTON		REEL		WEIGHT
	Size (dn)	Inside (mm)	Outside (mm)	Static (mm)	Dynamic (mm)	Metre	Article No. black	Metre	Article No. black	Metre	
7,5	6,7	10	15	45	50	801.707.0	-	-	-	-	0,02
10	9,9	13	20	60	50	801.710.0	-	-	-	-	0,03
12	12,2	15,7	30	90	50	801.712.0	-	-	-	-	0,035
17	16,6	21,2	35	105	50	801.717.0	-	-	-	-	0,06
23	23,2	28,3	45	135	50	801.723.0	-	-	-	-	0,09
29	29	34,5	65	195	25	801.729.0	-	-	-	-	0,13
37	36,6	42,4	90	270	25	801.736.0	-	-	-	-	0,18
50	47,7	53,7	130	390	25	801.748.0	-	-	-	-	0,23

The fittings for Ana-Quick Profi are outlined in this chapter on pages 9 - 13 till 9 - 25

ANA-QUICK	7,5	10	12	17	23	29	37	50
ISO	M12	M12 - M16	M16 - M20	M20 - M25	M25	M32	M40	M50 - M63
PG	7	7 - 9 - 11	11 - 13,5	13,5 - 16	21	29	36	48
NPT	-	-	-	-	-	-	-	-

Ana-Quick  
Profi



# Ana-Quick polyamide conduit

## PA12S BLACK



### SPECIAL MODEL FOR FREQUENT MOVEMENTS

Type PA12S is a special polyamide conduit for frequent movements. The PA12S is applicable for circumstances, where frequent movements occur, such as in dynamic machinery and robotics.

#### Material & Construction:

**Construction:** Corrugated conduit from modified polyamide PA12, UV resistant, halogen free.

**Temperature:** -40 °C till +100 °C, intermittent up to +130 °C.

**Flame properties:** Flame-retarding UL-94 HB.

**Colour:** Black (grey is available on request).

**Resistant against:** Alcohol, grease, fuels, mineral oils, weak bases and weak acids.

#### Classification according to NEN-EN-IEC 61386:

**Compression resistance:** Class 2, Light (320 N).

**Impact resistance:** Class 2, Light (1 J).

**Tensile strength:** Class 2, Light (250 N).

**Protection class:** IP 67 (dust-proof, water-tight).



Normal profile "standard wall"

ANA-QUICK	DIAMETRE		BENDING RADIUS (CL)		STANDARD CARTON		SMALL CARTON		REEL		WEIGHT (kg/m)
	Size (dn)	Inside (mm)	Outside (mm)	Static (mm)	Dynamic (mm)	Metre	Article No. black	Metre	Article No. black	Metre	
10	9,9	13	20	60	50	802.510.0	-	-	-	-	0,02
12	12,2	15,7	30	90	50	802.512.0	-	-	-	-	0,03
17	16,6	21,2	45	135	50	802.517.0	-	-	-	-	0,055
23	23,2	28,3	55	165	50	802.523.0	-	-	-	-	0,085
29	29	34,5	65	195	25	802.529.0	-	-	-	-	0,126
37	36	42,4	90	270	25	802.536.0	-	-	-	-	0,187
50	47,7	54	100	300	25	802.548.0	-	-	-	-	0,217

The fittings for Ana-Quick Profi are outlined in this chapter on pages 9 - 13 till 9 - 25

ANA-QUICK	7,5	10	12	17	23	29	37	50
ISO	M12	M12 - M16	M16 - M20	M20 - M25	M25	M32	M40	M50 - M63
PG	7	7 - 9 - 11	11 - 13,5	13,5 - 16	21	29	36	48
NPT	-	-	-	-	-	-	-	-

# Ana-Quick polyamide conduit

## PP MOD BLACK



### LIGHT MODEL, FOR LIGHT AND MEDIUM MECHANICAL STRENGTH

The PP Mod is applicable for standard circumstances and for low movements. The PP Mod is used in light machines and in the vehicle industry, specifically static applications.

#### Material & Construction:

**Construction:** Corrugated conduit from modified polypropylene (PP), UV resistant. **Temperature:** -40 °C till +135 °C, intermittent up to +150 °C.

**Flame properties:** Self-extinguishing UL- 94 V2. **Colour:** Black.

**Resistant against:** Alcohol, grease, fuels, mineral oils, weak bases and weak acids.

#### Classification according to NEN-EN-IEC 61386:

**Compression resistance:** Class 1, Very Light (125 N).

**Impact resistance:** Class 1, Very Light (0,5 J).

**Tensile strength:** Class 1, Very Light (100 N).

**Protection class:** IP 67 (dust-proof, water-tight).



Normal profile "thin wall"

ANA-QUICK	DIAMETRE		BENDING RADIUS (CL)		STANDARD CARTON		SMALL CARTON		REEL		WEIGHT (kg/m)
	Size (dn)	Inside (mm)	Outside (mm)	Static (mm)	Dynamic (mm)	Metre	Article No. black	Metre	Article No. black	Metre	
4,5	5	7,1	8	32	100	802.805.0	-	-	9000	802.805.5	0,01
6	6	9,2	10	40	100	802.806.0	-	-	5000	802.806.5	0,012
7,5	6,9	9,9	11	44	50	802.807.0	-	-	5000	802.807.5	0,013
10	10,1	12,7	17	68	50	802.810.0	-	-	3000	802.810.5	0,015
12	12	15,6	25	100	50	802.812.0	-	-	2000	802.812.5	0,021
14	14,5	18,3	30	120	50	802.814.0	-	-	1700	802.814.5	0,023
17	16,8	21	38	152	50	802.817.0	-	-	1300	802.817.5	0,031
19	19,4	24	44	176	50	802.819.0	-	-	1000	802.819.5	0,042
23	23,7	28	50	200	50	802.823.0	-	-	700	802.823.5	0,055
26	26,4	31,3	56	224	50	802.826.0	-	-	600	802.826.5	0,068
29	29,3	33,9	60	240	25	802.829.0	-	-	500	802.829.5	0,07
37	36,7	42	80	320	25	802.836.0	-	-	300	802.836.5	0,088
50	47,8	53,6	90	360	25	802.848.0	-	-	200	802.848.5	0,12

\* Also available in slitted execution (article number 802.xxx.7 for standard cartons).

The fittings for Ana-Quick Profi are outlined in this chapter on pages 9 - 13 till 9 - 25

ANA-QUICK	7,5	10	12	17	23	29	37	50
ISO	M12	M12 - M16	M16 - M20	M20 - M25	M25	M32	M40	M50 - M63
PG	7	7 - 9 - 11	11 - 13,5	13,5 - 16	21	29	36	48
NPT	-	-	-	-	-	-	-	-

Ana-Quick  
Profi

# Ana-Quick polyamide conduit

## PA6 DUO BLACK



### STANDARD DUO MODEL, FOR MEDIUM AND HEAVY MECHANICAL STRENGTH

The DUO PA6 is applicable for circumstances where intermediate repair is expected. Also for repair afterwards or when wires or cables have to be replaced type DUO PA6 is a perfect solution. Another feature of type DUO PA6 is the fact that the standard Ana-Quick Profi fittings can be used. Type DUO PA6 is used in medium and heavy machines, in computer installations, in cabinet building, hospital-building, packaging-machines and the transportation area.

#### Material & Construction:

**Construction:** Corrugated conduit from modified polyamide PA6 in slitted execution, UV resistant, halogen free.

**Flame properties:** Class HB, according UL-94, flame-retarding.

**Resistant against:** Alcohol, greases, fuels, mineral oils, weak bases and weak acids.

**Temperature:** -40°C till +120°C, intermittent up to +150°C.

**Colour:** Black.

#### Classification according to NEN-EN-IEC 61386:

**Compression resistance:** Class 3, Medium (750 N).

**Impact resistance:** Class 3, Medium (2 J).

**Tensile strength:** Class 3, Medium (500 N).

**Protection class:** IP 54.



Normal profile "double wall"

ANA-QUICK	DIAMETRE		BENDING RADIUS (CL)		STANDARD CARTON		SMALL CARTON		REEL		WEIGHT (kg/m)
	Size (dn)	Inside (mm)	Outside (mm)	Static (mm)	Dynamic (mm)	Metre	Article No. black	Metre	Article No. black	Metre	
7,5	5,6	10,3	25	45	50	802.907.0	-	-	-	-	0,025
10	8,5	13,3	33	90	50	802.910.0	-	-	-	-	0,036
13	11	16	35	135	50	802.913.0	-	-	-	-	0,053
16	13	19	42	180	50	802.916.0	-	-	-	-	0,061
17	15,5	21,5	45	210	50	802.917.0	-	-	-	-	0,068
22	19,1	25,6	55	230	50	802.922.0	-	-	-	-	0,098
23	21,9	28,5	68	240	50	802.923.0	-	-	-	-	0,104
26	24	31,7	80	270	25	802.926.0	-	-	-	-	0,122
29	27,2	35	120	360	25	802.929.0	-	-	-	-	0,155
37	32	42,5	145	400	25	802.936.0	-	-	-	-	0,195
50	43,9	53,9	150	450	25	802.948.0	-	-	-	-	0,262

The fittings for Ana-Quick Profi are outlined in this chapter on pages 9 - 13 till 9 - 25

ANA-QUICK	7,5	10	12	17	23	29	37	50
ISO	M12	M12 - M16	M16 - M20	M20 - M25	M25	M32	M40	M50 - M63
PG	7	7 - 9 - 11	11 - 13,5	13,5 - 16	21	29	36	48
NPT	-	-	-	-	-	-	-	-

# Ana-Quick polyamide conduit

## PP MOD DUO BLACK



### LIGHT DUO MODEL, FOR LIGHT MECHANICAL STRENGTH

The DUO PP-MOD is applicable for circumstances where intermediate repair is expected. Also for repair afterwards or when wires or cables have to be replaced type DUO PP-MOD is a perfect solution. Another feature of type DUO PP-MOD is the fact that the standard Ana-Quick Profi fittings can be used. Type DUO PP-MOD is used in the automotive industry and the transportation area.

#### Material & Construction:

**Construction:** Corrugated conduit from modified polypropylene PP, in slitted duo execution. **Temperature:** -40°C till +135°C, intermittent up to +150°C.

**Flame properties:** Class V2, according UL-94, flame-retarding. **Colour:** Black.

**Resistant against:** Alcohol, greases, fuels, mineral oils, weak bases and weak acids.

#### Classification according to NEN-EN-IEC 61386:

**Compression resistance:** Class 2, Light (320 N).

**Impact resistance:** Class 2, Light (1 J).

**Tensile strength:** Class 2, Light (250 N).

**Protection class:** IP 54.



Normal profile "double wall"

ANA-QUICK	DIAMETRE		BENDING RADIUS (CL)		STANDARD CARTON		SMALL CARTON		REEL		WEIGHT
	Size (dn)	Inside (mm)	Outside (mm)	Static (mm)	Dynamic (mm)	Metre	Article No. black	Metre	Article No. black	Metre	
7,5	5,6	10,3	25	45	50	802.207.0	-	-	-	-	0,02
10	8,5	13,3	28	90	50	802.210.0	-	-	-	-	0,028
13	11	16	35	135	50	802.213.0	-	-	-	-	0,037
16	13	18,9	40	180	50	802.216.0	-	-	-	-	0,051
17	15,1	21,3	45	210	50	802.217.0	-	-	-	-	0,056
22	19,6	25,4	55	230	50	802.222.0	-	-	-	-	0,07
23	21,6	28,1	60	240	50	802.223.0	-	-	-	-	0,09
26	24	31,5	65	270	25	802.226.0	-	-	-	-	0,106
29	26,6	34,4	100	300	25	802.229.0	-	-	-	-	0,128
37	31,8	42,7	120	360	25	802.236.0	-	-	-	-	0,15
50	43,9	53,9	140	420	25	802.248.0	-	-	-	-	0,225

Ana-Quick  
Profi

The fittings for Ana-Quick Profi are outlined in this chapter on pages 9 - 13 till 9 - 25

ANA-QUICK	7,5	10	12	17	23	29	37	50
ISO	M12	M12 - M16	M16 - M20	M20 - M25	M25	M32	M40	M50 - M63
PG	7	7 - 9 - 11	11 - 13,5	13,5 - 16	21	29	36	48
NPT	-	-	-	-	-	-	-	-

# Ana-Quick polyamide conduit

## PP UV DUO BLACK



### LIGHT DUO MODEL, FOR LIGHT MECHANICAL STRENGTH

The DUO PP-UV is applicable for circumstances where intermediate repair is expected. Also for repair afterwards or when wires or cables have to be replaced type DUO PP-UV is a perfect solution. Another feature of type DUO PP-UV is the fact that the standard Ana-Quick Profi fittings can be used. Type DUO PP-UV is used in light machines, in packaging-machines and the transportation area.

#### Material & Construction:

**Construction:** Corrugated conduit from modified poly-propylene PP, UV resistant, in slitted duo execution.

**Flame properties:** Class V2, according UL-94, flame-retarding.

**Resistant against:** Alcohol, greases, fuels, mineral oils, weak bases and weak acids.

**Temperature:** -40°C till +100°C, intermittent up to +125°C.

**Colour:** Black.

#### Classification according to NEN-EN-IEC 61386:

**Compression resistance:** Class 2, Light (320 N).

**Impact resistance:** Class 2, Light (1 J).

**Tensile strength:** Class 2, Light (250 N).

**Protection class:** IP 54.



Normal profile "double wall"

ANA-QUICK	DIAMETRE		BENDING RADIUS (CL)		STANDARD CARTON		SMALL CARTON		REEL		WEIGHT	
	Size (dn)	Inside (mm)	Outside (mm)	Static (mm)	Dynamic (mm)	Metre	Article No. black	Metre	Article No. black	Metre		Article No. black
	7,5	5,6	10,3	25	45	50	802.307.0	-	-	-	-	0,02
	10	8,5	13,3	28	90	50	802.310.0	-	-	-	-	0,022
	13	11	16	35	135	50	802.313.0	-	-	-	-	0,04
	16	13,3	18,9	40	180	50	802.316.0	-	-	-	-	0,054
	17	15,1	21,3	45	210	50	802.317.0	-	-	-	-	0,06
	22	19,6	25,4	55	230	50	802.322.0	-	-	-	-	0,078
	23	21,6	28,1	60	240	50	802.323.0	-	-	-	-	0,098
	26	24	31,5	65	270	25	802.326.0	-	-	-	-	0,112
	29	26,6	34,4	100	300	25	802.329.0	-	-	-	-	0,134
	37	31,8	42,7	120	360	25	802.336.0	-	-	-	-	0,163
	50	43,9	53,9	140	420	25	802.348.0	-	-	-	-	0,245

The fittings for Ana-Quick Profi are outlined in this chapter on pages 9 - 13 till 9 - 25

ANA-QUICK	7,5	10	12	17	23	29	37	50
ISO	M12	M12 - M16	M16 - M20	M20 - M25	M25	M32	M40	M50 - M63
Pg	7	7 - 9 - 11	11 - 13,5	13,5 - 16	21	29	36	48
NPT	-	-	-	-	-	-	-	-

# Ana-Quick polyamide fittings, IP 65 / IP 68



## ANA-QUICK POLYAMIDE FITTINGS

The universal Ana-Quick Profi fitting is available in a wide range of different threads and fits all types of Ana-Quick conduit. The Ana-Quick Profi fitting is easy to connect and due to the integrated release clips also very simple to dis-connect. Also available in IP 68 execution.

### Material & Construction:

**Construction:** 1 piece fitting with integrated release clips.

**Material:** Fitting and clips are made of halogen free Polyamide PA6.

**Temperature:** -40°C till +120°C continuous.

**Protection class:** IP 65 (dust-proof, water-protected). In case a special O-ring is mounted, in the first corrugation of the conduit, an IP 68 protection will be achieved.

**Colour:** Black or grey.

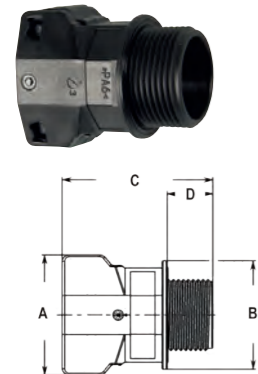

ISO straight fitting, male, PA6, colour black



THREAD ISO	ANA-QUICK SIZE (DN)	MIN. INTERNAL BORE (MM)	DIMENSIONS IN MM					STANDARD PACKAGE	ARTICLE NUMBER	WEIGHT (KG/100)
			A	B	C	D	E			
M12 x 1,5	7,5	7,5	19	18	34	11	-	50	268.112.1	0,4
M12 x 1,5	10	7,5	22	22	36	12	-	50	268.112.0	0,4
M16 x 1,5	10	11	22	22	36	12	-	50	268.116.1	0,5
M16 x 1,5	12	11	26	25	38	12	-	50	268.116.0	0,6
M20 x 1,5	12	15,2	26	25	38	12	-	50	268.120.1	0,6
M20 x 1,5	17	15,4	35	31	43	13	-	50	268.120.0	1,2
M25 x 1,5	17	19,1	35	31	43	13	-	50	268.125.1	1,3
M25 x 1,5	23	19,1	43	38	48	13	-	25	268.125.0	1,9
M32 x 1,5	29	25,5	50	46	52	15	-	20	268.132.0	2,8
M40 x 1,5	37	34	59	55	62	17	-	10	268.140.0	4,4
M50 x 1,5	50	43,5	72	72	68	19	-	5	268.150.0	7,4
M63 x 1,5	50	53,2	72	72	68	19	-	5	268.163.0	7,4

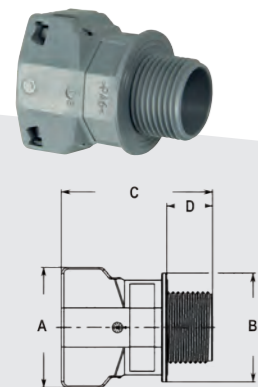

ISO straight fitting, male, PA6, colour grey



THREAD ISO	ANA-QUICK SIZE (DN)	MIN. INTERNAL BORE (MM)	DIMENSIONS IN MM					STANDARD PACKAGE	ARTICLE NUMBER	WEIGHT (KG/100)
			A	B	C	D	E			
M12 x 1,5	7,5	7,5	19	18	34	11	-	50	268.012.1	0,4
M12 x 1,5	10	7,5	22	22	36	12	-	50	268.012.0	0,4
M16 x 1,5	10	11	22	22	36	12	-	50	268.016.1	0,5
M16 x 1,5	12	11	26	25	38	12	-	50	268.016.0	0,6
M20 x 1,5	12	15,2	26	25	38	12	-	50	268.020.1	0,6
M20 x 1,5	17	15,4	35	31	43	13	-	50	268.020.0	1,2
M25 x 1,5	17	19,1	35	31	43	13	-	50	268.025.1	1,3
M25 x 1,5	23	19,1	43	38	48	13	-	25	268.025.0	1,9
M32 x 1,5	29	25,5	50	46	52	15	-	20	268.032.0	2,8
M40 x 1,5	37	34	59	55	62	17	-	10	268.040.0	4,4
M50 x 1,5	50	43,5	72	72	68	19	-	5	268.050.0	7,4
M63 x 1,5	50	53,2	72	72	68	19	-	5	268.063.0	7,4

Ana-Quick  
Profi



## ANA-QUICK POLYAMIDE FITTINGS, IP 65 / IP 68

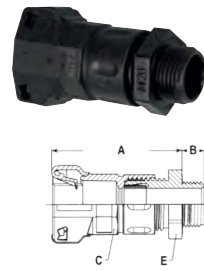

ISO straight cable-hose fitting, male, PA6, colour black



THREAD ISO	ANA-QUICK SIZE (DN)	CLAMPING RANGE (MM)	DIMENSIONS IN MM					STANDARD PACKAGE	ARTICLE NUMBER	WEIGHT (KG/100)
			A	B	C	D	E			
M16 x 1,5	10	2,5 - 8,0	47	10	17	-	19	50	267.016.1	3,5
M16 x 1,5	12	3,5 - 10,0	53	10	20	-	22	50	267.016.0	3,5
M20 x 1,5	12	5,0 - 12,0	53	10	20	-	24	50	267.020.1	4
M20 x 1,5	17	5,0 - 12,0	59	10	27	-	24	50	267.020.0	4
M20 x 1,5	17	7,0 - 14,0	59	10	27	-	27	50	267.020.2	4
M25 x 1,5	17	7,0 - 14,0	59	10	27	-	27	50	267.025.1	4,2
M25 x 1,5	23	9,0 - 18,0	69	10	34	-	33	25	267.025.0	4,2
M32 x 1,5	29	14,0 - 25,0	75	10	41	-	42	10	267.032.0	4,5



ISO 90° elbow fitting, male, PA6, colour black



THREAD ISO	ANA-QUICK SIZE (DN)	MIN. INTERNAL BORE (MM)	DIMENSIONS IN MM					STANDARD PACKAGE	ARTICLE NUMBER	WEIGHT (KG/100)
			A	B	C	D	E			
M16 x 1,5	10	9,5	22	20	50	12	29	50	268.316.1	0,6
M16 x 1,5	12	9,5	26	20	53	12	31	50	268.316.0	0,8
M20 x 1,5	12	13,5	26	25	55	12	34	50	268.320.1	1
M20 x 1,5	17	13,5	35	25	60	12	39	25	268.320.0	1,6
M25 x 1,5	17	17	35	31	66	13	45	25	268.325.1	1,9
M25 x 1,5	23	17	43	31	72	13	49	20	268.325.0	2,6
M32 x 1,5	23	23	43	38	74	13	52	20	268.332.1	3,7
M32 x 1,5	29	23	50	38	77	13	55	10	268.332.0	3,8
M40 x 1,5	29	31	50	48	87	15	64	10	268.340.1	4,8
M40 x 1,5	37	31	59	48	96	15	69	10	268.340.0	6,3
M50 x 1,5	37	39,5	59	56	105	17	75	10	268.350.1	7,8
M50 x 1,5	50	39,5	72	56	111	17	90	5	268.350.0	10,3
M63 x 1,5	50	51,5	72	72	129	19	100	5	268.363.0	13,5

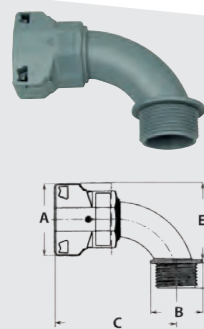

ISO 90° elbow fitting, male, PA6, colour grey



THREAD ISO	ANA-QUICK SIZE (DN)	MIN. INTERNAL BORE (MM)	DIMENSIONS IN MM					STANDARD PACKAGE	ARTICLE NUMBER	WEIGHT (KG/100)
			A	B	C	D	E			
M16 x 1,5	10	9,5	22	20	50	12	29	50	268.216.1	0,6
M16 x 1,5	12	9,5	26	20	53	12	31	50	268.216.0	0,8
M20 x 1,5	12	13,5	26	25	55	12	34	50	268.220.1	1
M20 x 1,5	17	13,5	35	25	60	12	39	25	268.220.0	1,6
M25 x 1,5	17	17	35	31	66	13	45	25	268.225.1	1,9
M25 x 1,5	23	17	43	31	72	13	49	20	268.225.0	2,6
M32 x 1,5	23	23	43	38	74	13	52	20	268.232.1	3,7
M32 x 1,5	29	23	50	38	77	13	55	10	268.232.0	3,8
M40 x 1,5	29	31	50	48	87	15	64	10	268.240.1	4,8
M40 x 1,5	37	31	59	48	96	15	69	10	268.240.0	6,3
M50 x 1,5	37	39,5	59	56	105	17	75	10	268.250.1	7,8
M50 x 1,5	50	39,5	72	56	111	17	90	5	268.250.0	10,3
M63 x 1,5	50	51,5	72	72	129	19	100	5	268.263.0	13,5

## ANA-QUICK POLYAMIDE FITTINGS, IP 65 / IP 68

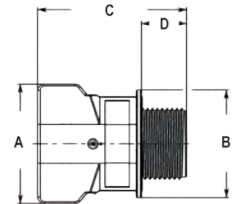

Pg straight fitting, male, PA6, colour black



THREAD PG	ANA-QUICK SIZE (DN)	MIN. INTERNAL BORE (MM)	DIMENSIONS IN MM					STANDARD PACKAGE	ARTICLE NUMBER	WEIGHT (KG/100)
			A	B	C	D	E			
Pg 7	7,5	7,5	19	18	34	11	-	50	268.507.0	0,4
Pg 7	10	9	22	22	36	12	-	50	268.507.1	0,5
Pg 9	10	11	22	22	36	12	-	50	268.509.0	0,4
Pg 9	12	11	26	25	38	12	-	50	268.509.1	0,6
Pg 11	10	12,5	22	22	36	12	-	50	268.511.1	0,5
Pg 11	12	14,5	26	25	38	12	-	50	268.511.0	0,6
Pg 13,5	12	15,2	26	25	38	12	-	50	268.513.1	1,2
Pg 13,5	17	15,4	35	31	43	13	-	50	268.513.0	1,2
Pg 16	17	18,1	35	31	43	13	-	50	268.516.0	1,2
Pg 21	23	23	43	38	48	13	-	25	268.521.0	1,9
Pg 29	29	31	50	46	52	15	-	20	268.529.0	2,8
Pg 36	37	39	59	55	62	17	-	10	268.536.0	4,7
Pg 48	50	43,5	72	72	68	19	-	5	268.548.0	7,3

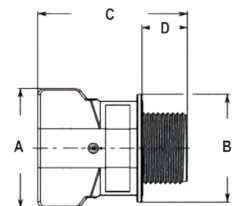

Pg straight fitting, male, PA6, colour grey



THREAD PG	ANA-QUICK SIZE (DN)	MIN. INTERNAL BORE (MM)	DIMENSIONS IN MM					STANDARD PACKAGE	ARTICLE NUMBER	WEIGHT (KG/100)
			A	B	C	D	E			
Pg 7	7,5	7,5	19	18	34	11	-	50	268.407.0	0,4
Pg 7	10	9	22	22	36	12	-	50	268.407.1	0,5
Pg 9	10	11	22	22	36	12	-	50	268.409.0	0,4
Pg 9	12	11	26	25	38	12	-	50	268.409.1	0,6
Pg 11	10	12,5	22	22	36	12	-	50	268.411.1	0,5
Pg 11	12	14,5	26	25	38	12	-	50	268.411.0	0,6
Pg 13,5	12	15,2	26	25	38	12	-	50	268.413.1	1,2
Pg 13,5	17	15,4	35	31	43	13	-	50	268.413.0	1,2
Pg 16	17	18,1	35	31	43	13	-	50	268.416.0	1,2
Pg 21	23	23	43	38	48	13	-	25	268.421.0	1,9
Pg 29	29	31	50	46	52	15	-	20	268.429.0	2,8
Pg 36	37	39	59	55	62	17	-	10	268.436.0	4,7
Pg 48	50	43,5	72	72	68	19	-	5	268.448.0	7,3

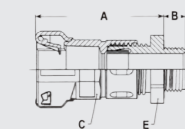

Pg straight cable-hose fitting, male, PA6, colour black



THREAD PG	ANA-QUICK SIZE (DN)	CLAMPING RANGE (MM)	DIMENSIONS IN MM					STANDARD PACKAGE	ARTICLE NUMBER	WEIGHT (KG/100)
			A	B	C	D	E			
Pg 9	10	2,5 - 8,0	47	8	17	-	19	25	267.109.0	3,5
Pg 11	12	3,5 - 10,0	53	8	20	-	22	25	267.111.0	4
Pg 13,5	12	5,0 - 12,0	53	9	20	-	24	25	267.113.1	4
Pg 13,5	17	5,0 - 12,0	59	9	27	-	24	25	267.113.0	4
Pg 16	17	7,0 - 14,0	59	10	27	-	27	25	267.116.0	4,2
Pg 21	23	9,0 - 18,0	69	11	34	-	33	25	267.121.0	4,2
Pg 29	29	14,0 - 25,0	75	11	41	-	42	10	267.129.0	4,5

Ana-Quick Profi

## ANA-QUICK POLYAMIDE FITTINGS, IP 65 / IP 68

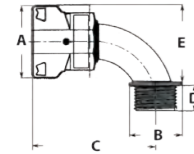

Pg 90° elbow fitting, male, PA6, colour black



THREAD PG	ANA-QUICK SIZE (DN)	MIN. INTERNAL BORE (MM)	DIMENSIONS IN MM					STANDARD PACKAGE	ARTICLE NUMBER	WEIGHT (KG/100)
			A	B	C	D	E			
Pg 9	10	9,5	22	20	50	12	29	50	268.709.0	0,6
Pg 11	12	13,5	26	25	55	12	34	50	268.711.0	0,9
Pg 13,5	17	13,5	35	25	60	12	39	25	268.713.0	1,5
Pg 16	17	17	35	31	66	13	45	25	268.716.0	1,8
Pg 21	23	23	43	38	74	13	52	20	268.721.0	2,9
Pg 29	29	31	50	48	87	15	64	10	268.729.0	4,5
Pg 36	37	39,5	59	56	105	17	75	10	268.736.0	7,4
Pg 48	50	51,5	72	72	129	19	100	5	268.748.0	12,7

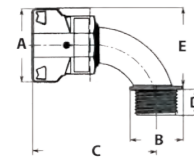

Pg 90° elbow fitting, male, PA6, colour grey



THREAD PG	ANA-QUICK SIZE (DN)	MIN. INTERNAL BORE (MM)	DIMENSIONS IN MM					STANDARD PACKAGE	ARTICLE NUMBER	WEIGHT (KG/100)
			A	B	C	D	E			
Pg 9	10	9,5	22	20	50	12	29	50	268.609.0	0,6
Pg 11	12	13,5	26	25	55	12	34	50	268.611.0	0,9
Pg 13,5	17	13,5	35	25	60	12	39	25	268.613.0	1,5
Pg 16	17	17	35	31	66	13	45	25	268.616.0	1,8
Pg 21	23	23	43	38	74	13	52	20	268.621.0	2,9
Pg 29	29	31	50	48	87	15	64	10	268.629.0	4,5
Pg 36	37	39,5	59	56	105	17	75	10	268.636.0	7,4
Pg 48	50	51,5	72	72	129	19	100	5	268.648.0	12,7



O-ring, NBR, to obtain IP 68 protection



ANA-QUICK SIZE (DN)	CONDUIT PA6L	CONDUIT PA6S	CONDUIT PA6SU	CONDUIT PA6VO	CONDUIT PP-MOD	STANDARD PACKAGE	ARTICLE NUMBER	WEIGHT (KG/100)
7,5	7,5	7,5	-	7,5	7,5	50	268.807.0	0,01
7,5	-	-	7,5	-	-	50	268.810.0	0,01
10	10	10	-	10	10	50	268.810.0	0,01
10	-	-	10	-	-	50	268.813.0	0,01
12	12	12	-	12	12	50	268.812.0	0,01
12	-	-	12	-	-	50	268.813.0	0,01
17	17	17	-	17	17	50	268.817.0	0,01
17	-	-	17	-	-	50	268.818.0	0,02
23	23	23	-	23	23	25	268.823.0	0,02
23	-	-	23	-	-	20	268.829.0	0,04
29	29	29	-	29	29	20	268.829.0	0,04
29	-	-	29	-	-	20	268.830.0	0,05
37	37	37	-	37	37	10	268.837.0	0,05
37	-	-	37	-	-	10	268.840.0	0,05
50	50	50	-	50	-	5	268.850.0	0,06



O-ring, NBR, to obtain IP 68 for fittings

To achieve the protection class IP 68, slip the O ring into the first groove of the cut end of the corrugated tube section on the screw side.

For normal profile size NW 50 slip two O-rings sealings into the first and second groove of the tube. Insert the tube in the closed gland with a slight twist until the collar stop.

## ANA-QUICK POLYAMIDE FITTINGS, IP 65 / IP 68

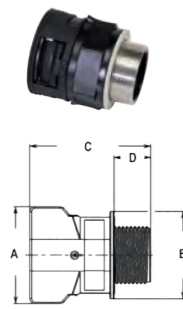

ISO straight fitting, nickel plated brass thread, male, PA6, colour black



THREAD ISO	ANA-QUICK SIZE (DN)	MIN. INTERNAL BORE (MM)	DIMENSIONS IN MM					STANDARD PACKAGE	ARTICLE NUMBER	WEIGHT (KG/100)
			A	B	C	D	E			
M16 x 1,5	10	10,8	22	22	38	12	-	30	265.116.1	1
M16 x 1,5	12	10,8	26	25	39	12	-	30	265.116.0	1,4
M20 x 1,5	12	10,6	26	25	39	12	-	30	265.120.1	1,4
M20 x 1,5	17	15,4	35	31	42	12	-	30	265.120.0	2
M25 x 1,5	17	17,7	35	31	44	14	-	30	265.125.1	2
M25 x 1,5	23	19,7	43	38	53	14	-	30	265.125.0	3,7
M32 x 1,5	29	26,9	50	46	54	14	-	20	265.132.0	5,3
M40 x 1,5	37	29,8	59	55	60	14	-	10	265.140.0	6,1
M50 x 1,5	50	35,5	72	72	70	18	-	10	265.150.0	10,4

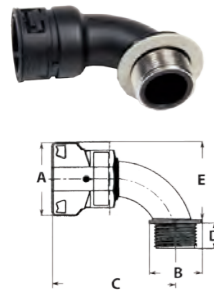

ISO 90° elbow fitting, nickel plated brass thread, male, PA6, colour black



THREAD ISO	ANA-QUICK SIZE (DN)	MIN. INTERNAL BORE (MM)	DIMENSIONS IN MM					STANDARD PACKAGE	ARTICLE NUMBER	WEIGHT (KG/100)
			A	B	C	D	E			
M16 x 1,5	10	8,7	22	20	50	11	29	30	265.316.1	1,2
M16 x 1,5	12	8,7	26	20	59	11	31	30	265.316.0	1,8
M20 x 1,5	12	11,9	26	25	55	12	34	30	265.320.1	1,2
M20 x 1,5	17	14,8	35	25	60	13	39	30	265.320.0	2,6
M25 x 1,5	17	16,7	35	31	66	13	45	30	265.325.1	2,6
M32 x 1,5	23	22,2	43	31	74	14	49	30	265.332.1	4,4
M32 x 1,5	29	23,2	50	38	77	14	55	20	265.332.0	7,1
M40 x 1,5	37	28,4	59	48	96	14	69	10	265.340.0	7,1
M50 x 1,5	37	36,2	59	56	105	14	75	10	265.350.1	10,6

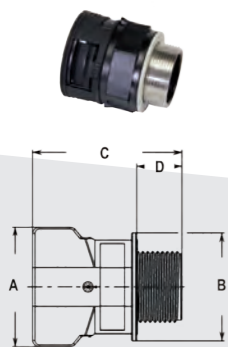

Pg straight fitting, nickel plated brass thread, male, PA6, colour black



THREAD PG	ANA-QUICK SIZE (DN)	MIN. INTERNAL BORE (MM)	DIMENSIONS IN MM					STANDARD PACKAGE	ARTICLE NUMBER	WEIGHT (KG/100)
			A	B	C	D	E			
Pg 9	10	10,5	22	22	38	12	-	30	265.509.0	0,9
Pg 11	12	13,4	26	25	39	12	-	30	265.511.0	1,4
Pg 13,5	17	15,4	35	31	42	12	-	30	265.513.0	1,9
Pg 16	17	17,5	35	31	42	12	-	30	265.516.0	2
Pg 21	23	22,4	43	38	53	14	-	30	265.521.0	3,7
Pg 29	29	30,2	50	46	54	14	-	20	265.529.0	5,3
Pg 36	37	36	59	55	64	17	-	10	265.536.0	8,4
Pg 48	50	47	72	72	69	17	-	10	265.548.0	15,2

Ana-Quick  
Profi

## ANA-QUICK POLYAMIDE FITTINGS, IP 65 / IP 68

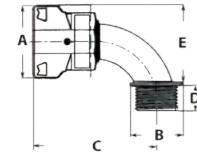

Pg 90° elbow fitting, nickel plated brass thread, male, PA6, colour black



THREAD PG	ANA-QUICK SIZE (DN)	MIN. INTERNAL BORE (MM)	DIMENSIONS IN MM					STANDARD PACKAGE	ARTICLE NUMBER	WEIGHT (KG/100)
			A	B	C	D	E			
Pg 9	10	10	22	20	50	11	29	30	265.709.0	1,2
Pg 11	12	12	26	25	55	11	34	30	265.711.0	1,8
Pg 13,5	17	14,8	35	25	60	13	39	30	265.713.0	1,8
Pg 16	17	16,8	35	31	66	14	45	30	265.716.0	2,8
Pg 21	23	22,3	43	38	74	14	52	30	265.721.0	4,5
Pg 29	29	29	50	48	87	14	64	20	265.729.0	7,1
Pg 36	37	36,4	59	56	105	14	75	10	265.736.0	11,8
Pg 48	50	49,7	72	72	129	14	100	10	265.748.0	17,5

Conduit holder, PA6, colour black

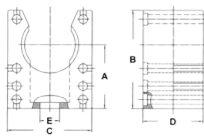

ANA-QUICK SIZE (DN)	ANA-QUICK TYPE	MIN. INTERNAL BORE (MM)	DIMENSIONS IN MM					STANDARD PACKAGE	ARTICLE NUMBER	WEIGHT (KG/100)
			A	B	C	D	E			
7,5	-	-	12	18	20	20	4,2	100	267.307.0	0,4
10	-	-	16	23	20	20	5,5	100	267.310.0	0,5
12	-	-	17	26	22	20	5,5	50	267.312.0	0,6
17	-	-	21	33	28	20	6,5	50	267.317.0	0,8
23	-	-	25	40	35	20	6,5	50	267.323.0	1,2
29	-	-	27	45	43	20	6,5	30	267.329.0	1,3
37	-	-	31	53	54	20	6,5	20	267.336.0	1,5
50	-	-	38	66	68	20	6,5	20	267.348.0	2

Conduit holder, PA6, colour grey

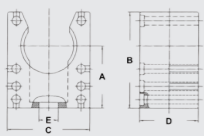

ANA-QUICK SIZE (DN)	ANA-QUICK TYPE	MIN. INTERNAL BORE (MM)	DIMENSIONS IN MM					STANDARD PACKAGE	ARTICLE NUMBER	WEIGHT (KG/100)
			A	B	C	D	E			
7,5	-	-	12	18	20	20	4,2	100	267.207.0	0,4
10	-	-	16	23	20	20	5,5	100	267.210.0	0,5
12	-	-	17	26	22	20	5,5	50	267.212.0	0,6
17	-	-	21	33	28	20	6,5	50	267.217.0	0,8
23	-	-	25	40	35	20	6,5	50	267.223.0	1,2
29	-	-	27	45	43	20	6,5	30	267.229.0	1,3
37	-	-	31	53	54	20	6,5	20	267.236.0	1,5
50	-	-	38	66	68	20	6,5	20	267.248.0	2

## ANA-QUICK POLYAMIDE FITTINGS, IP 65 / IP 68



Conduit holder cover, PA6, colour black



ANA-QUICK SIZE (DN)	ANA-QUICK TYPE	MIN. INTERNAL BORE (MM)	DIMENSIONS IN MM					STANDARD PACKAGE	ARTICLE NUMBER	WEIGHT (KG/100)
			A	B	C	D	E			
7,5	-	-	-	-	-	-	-	100	267.507.0	0,1
10	-	-	-	-	-	-	-	100	267.510.0	0,1
12	-	-	-	-	-	-	-	50	267.512.0	0,2
17	-	-	-	-	-	-	-	50	267.517.0	0,2
23	-	-	-	-	-	-	-	50	267.523.0	0,2
29	-	-	-	-	-	-	-	30	267.529.0	0,2
37	-	-	-	-	-	-	-	20	267.536.0	0,3
50	-	-	-	-	-	-	-	20	267.548.0	0,3



Conduit holder cover, PA6, colour grey



ANA-QUICK SIZE (DN)	ANA-QUICK TYPE	MIN. INTERNAL BORE (MM)	DIMENSIONS IN MM					STANDARD PACKAGE	ARTICLE NUMBER	WEIGHT (KG/100)
			A	B	C	D	E			
7,5	-	-	-	-	-	-	-	100	267.407.0	0,1
10	-	-	-	-	-	-	-	100	267.410.0	0,1
12	-	-	-	-	-	-	-	50	267.412.0	0,2
17	-	-	-	-	-	-	-	50	267.417.0	0,2
23	-	-	-	-	-	-	-	50	267.423.0	0,2
29	-	-	-	-	-	-	-	30	267.429.0	0,2
37	-	-	-	-	-	-	-	20	267.436.0	0,3
50	-	-	-	-	-	-	-	20	267.448.0	0,3



Conduit holder connector, PA6, colour black



ANA-QUICK SIZE (DN)	MIN. INTERNAL BORE (MM)	DIMENSIONS IN MM					STANDARD PACKAGE	ARTICLE NUMBER	WEIGHT (KG/100)
		A	B	C	D	E			
7,5 - 50	-	-	-	-	-	-	100	267.501.0	0,04



Conduit holder connector, PA6, colour grey



ANA-QUICK SIZE (DN)	MIN. INTERNAL BORE (MM)	DIMENSIONS IN MM					STANDARD PACKAGE	ARTICLE NUMBER	WEIGHT (KG/100)
		A	B	C	D	E			
7,5 - 50	-	-	-	-	-	-	100	267.500.0	0,04

Ana-Quick  
Profi



## ANA-QUICK POLYAMIDE FITTINGS, IP 65 / IP 68

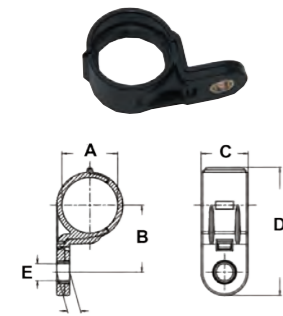

Conduit mounting clip, PA46, with inner contour



CONDUIT SIZE INSIDE DN	CONDUIT SIZE REDUCTION DN	DIMENSIONS IN MM					STANDARD PACKAGE	ARTICLE NUMBER	WEIGHT (KG/100)
		A	B	C	D	E			
10	-	13,2	22	18	41	6,5	500	267.610.0	0,4
13	-	16,1	23	18	44	6,5	500	267.613.0	0,4
17	-	21,4	26	18	49	6,5	500	267.617.0	0,5
22	-	25,9	28	18	54	6,5	500	267.622.0	0,6



Conduit reducer ring, PA66, for inside mounting in conduit



CONDUIT SIZE INSIDE DN	CONDUIT SIZE REDUCTION DN	DIMENSIONS IN MM					STANDARD PACKAGE	ARTICLE NUMBER	WEIGHT (KG/100)
		A	B	C	D	E			
10	4,5	-	-	-	-	-	2000	267.710.0	0,1
10	7,5	-	-	-	-	-	2000	267.711.0	0,1
13	10	-	-	-	-	-	2000	267.713.0	0,2
13	7,5	-	-	-	-	-	500	267.714.0	0,2
17	13	-	-	-	-	-	500	267.717.0	0,3



Conduit split ring, PA66, for inside mounting in conduit



CONDUIT SIZE INSIDE DN	CONDUIT SIZE REDUCTION DN	DIMENSIONS IN MM					STANDARD PACKAGE	ARTICLE NUMBER	WEIGHT (KG/100)
		A	B	C	D	E			
17	4,5 - 4,5	-	-	-	-	-	500	267.817.0	0,3
22	7,5 - 7,5	-	-	-	-	-	1000	267.820.0	0,3
22	8,5 - 7,5	-	-	-	-	-	1000	267.821.0	0,3
22	4,5 - 4,5	-	-	-	-	-	1000	267.822.0	0,3



Neoprene, end cap, with strain relief, IP 54



ANA-QUICK SIZE (DN)	ANA-QUICK TYPE	CLAMPING RANGE (MM)	DIMENSIONS IN MM					STANDARD PACKAGE	ARTICLE NUMBER	WEIGHT (KG/100)
			A	B	C	D	E			
12	-	4 - 9	-	-	-	-	-	3000	266.812.0	0,3
17	-	5 - 12	-	-	-	-	-	2400	266.817.0	0,6
23	-	7 - 17	-	-	-	-	-	1200	266.823.0	1,1
29	-	9 - 20	-	-	-	-	-	800	266.829.0	1,4
37	-	16 - 30	-	-	-	-	-	800	266.836.0	1,9

## ANA-QUICK POLYAMIDE FITTINGS, IP 65 / IP 68

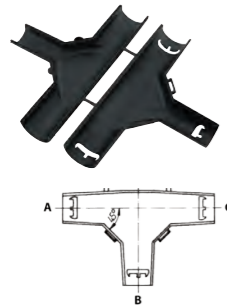

T - joint, conduit at outside connected, colour black, IP 40



T-JOINT SIZE DN - DN - DN	MIN. INTERNAL BORE (MM)	DIMENSIONS IN NW					STANDARD PACKAGE	ARTICLE NUMBER	WEIGHT (KG/100)
		A	B	C	D	E			
10 - 10 - 10	-	10	10	10	-	-	100	799.801.0	0,6
10 - 17 - 23	-	10	17	23	-	-	100	799.807.0	0,8
17 - 17 - 10	-	17	17	10	-	-	100	799.802.0	0,8
17 - 17 - 17	-	17	17	17	-	-	100	799.803.0	0,9
23 - 23 - 10	-	23	23	10	-	-	100	799.804.0	0,9
23 - 23 - 17	-	23	23	17	-	-	100	799.805.0	0,9
23 - 23 - 23	-	23	23	23	-	-	250	799.806.0	1



T - joint, conduit at inside connected, colour black, IP 40



T-JOINT SIZE DN - DN - DN	MIN. INTERNAL BORE (MM)	DIMENSIONS IN NW					STANDARD PACKAGE	ARTICLE NUMBER	WEIGHT (KG/100)
		A	B	C	D	E			
7,5 - 7,5 - 7,5	-	7,5	7,5	7,5	-	-	500	797.701.0	0,5
10 - 7,5 - 7,5	-	10	7,5	7,5	-	-	500	797.702.0	0,5
10 - 10 - 7,5	-	10	10	7,5	-	-	500	797.703.0	0,7
10 - 10 - 10	-	10	10	10	-	-	500	797.704.0	0,7
12 - 12 - 7,5	-	12	12	7,5	-	-	500	797.705.0	0,7
12 - 10 - 10	-	12	10	10	-	-	500	797.706.0	0,7
17 - 10 - 17	-	17	10	17	-	-	500	797.707.0	0,7
17 - 12 - 12	-	17	12	12	-	-	500	797.708.0	0,8
17 - 12 - 17	-	17	12	17	-	-	250	797.709.0	0,8
17 - 23 - 17	-	17	23	17	-	-	250	797.710.0	0,8
23 - 10 - 23	-	23	10	23	-	-	100	797.711.0	1,2
23 - 12 - 23	-	23	12	23	-	-	500	797.712.0	1,2
23 - 17 - 12	-	23	17	12	-	-	250	797.713.0	1,2
23 - 23 - 10	-	23	23	10	-	-	100	797.714.0	1,2
23 - 23 - 23	-	23	23	23	-	-	500	797.715.0	1,2



Y - joint, conduit at inside connected, colour black, IP 40



Y-JOINT SIZE DN - DN - DN	MIN. INTERNAL BORE (MM)	DIMENSIONS IN NW					STANDARD PACKAGE	ARTICLE NUMBER	WEIGHT (KG/100)
		A	B	C	D	E			
12 - 10 - 10	-	12	10	10	-	-	500	797.801.0	0,8
12 - 10 - 12	-	12	10	12	-	-	500	797.802.0	0,8
12 - 12 - 12	-	12	12	12	-	-	500	797.803.0	0,8
17 - 10 - 10	-	17	10	10	-	-	500	797.804.0	0,9
17 - 10 - 17	-	17	10	17	-	-	500	797.805.0	0,9
17 - 12 - 10	-	17	12	10	-	-	500	797.806.0	0,9
17 - 12 - 12	-	17	12	12	-	-	500	797.807.0	0,9
17 - 17 - 10	-	17	17	10	-	-	500	797.808.0	0,9
23 - 10 - 23	-	23	10	23	-	-	100	797.809.0	1,1
23 - 12 - 23	-	23	12	23	-	-	100	797.810.0	1,1
23 - 23 - 23	-	23	23	23	-	-	250	797.811.0	1,1

Ana-Quick  
Profi

## ANA-QUICK POLYAMIDE FITTINGS, IP 65 / IP 68

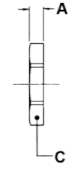

ISO locknuts, glassfiber reinforced polyamide, colour black



THREAD ISO	ANA-QUICK	MIN. INTERNAL BORE (MM)	DIMENSIONS IN MM					STANDARD PACKAGE	ARTICLE NUMBER	WEIGHT (KG/100)
			A	B	C	D	E			
M12 x 1,5	-	-	5	-	19	-	-	50	798.312.3	0,1
M16 x 1,5	-	-	5	-	22	-	-	50	798.316.3	0,2
M20 x 1,5	-	-	5	-	24	-	-	50	798.320.3	0,3
M25 x 1,5	-	-	6	-	30	-	-	20	798.325.3	0,3
M32 x 1,5	-	-	8	-	38	-	-	20	798.332.3	0,3
M40 x 1,5	-	-	8	-	50	-	-	20	798.340.3	0,9
M50 x 1,5	-	-	-	-	-	-	-	10	798.350.3	1,3
M63 x 1,5	-	-	-	-	-	-	-	5	798.363.3	2,2

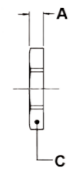

ISO locknuts, glassfiber reinforced polyamide, colour grey



THREAD ISO	ANA-QUICK	MIN. INTERNAL BORE (MM)	DIMENSIONS IN MM					STANDARD PACKAGE	ARTICLE NUMBER	WEIGHT (KG/100)
			A	B	C	D	E			
M12 x 1,5	-	-	5	-	19	-	-	50	798.312.0	0,1
M16 x 1,5	-	-	5	-	22	-	-	50	798.316.0	0,2
M20 x 1,5	-	-	5	-	24	-	-	50	798.320.0	0,3
M25 x 1,5	-	-	6	-	30	-	-	20	798.325.0	0,3
M32 x 1,5	-	-	8	-	38	-	-	20	798.332.0	0,3
M40 x 1,5	-	-	8	-	50	-	-	20	798.340.0	0,9
M50 x 1,5	-	-	-	-	-	-	-	10	798.350.0	1,3
M63 x 1,5	-	-	-	-	-	-	-	5	798.363.0	2,2



Pg locknuts, glassfiber reinforced polyamide, colour black



THREAD PG	ANA-QUICK	MIN. INTERNAL BORE (MM)	DIMENSIONS IN MM					STANDARD PACKAGE	ARTICLE NUMBER	WEIGHT (KG/100)
			A	B	C	D	E			
Pg 7	-	-	5	-	19	-	-	50	269.907.3	0,1
Pg 9	-	-	5	-	22	-	-	50	269.909.3	0,2
Pg 11	-	-	5	-	24	-	-	50	269.911.3	0,2
Pg 13,5	-	-	6	-	27	-	-	50	269.913.3	0,2
Pg 16	-	-	6	-	30	-	-	20	269.916.3	0,3
Pg 21	-	-	7	-	36	-	-	20	269.921.3	0,4
Pg 29	-	-	8	-	46	-	-	20	269.929.3	0,7
Pg 36	-	-	8	-	60	-	-	10	269.936.3	1,1
Pg 48	-	-	10	-	70	-	-	5	269.948.3	1,3

## ANA-QUICK POLYAMIDE FITTINGS, IP 65 / IP 68

Pg locknuts, glassfiber reinforced polyamide, colour grey



THREAD PG	ANA-QUICK	MIN. INTERNAL BORE (MM)	DIMENSIONS IN MM					STANDARD PACKAGE	ARTICLE NUMBER	WEIGHT (KG/100)
			A	B	C	D	E			
Pg 7	-	-	5	-	19	-	-	50	269.907.0	0,1
Pg 9	-	-	5	-	22	-	-	50	269.909.0	0,2
Pg 11	-	-	5	-	24	-	-	50	269.911.0	0,2
Pg 13,5	-	-	6	-	27	-	-	50	269.913.0	0,2
Pg 16	-	-	6	-	30	-	-	20	269.916.0	0,3
Pg 21	-	-	7	-	36	-	-	20	269.921.0	0,4
Pg 29	-	-	8	-	46	-	-	20	269.929.0	0,7
Pg 36	-	-	8	-	60	-	-	10	269.936.0	1,1
Pg 48	-	-	10	-	70	-	-	5	269.948.0	1,3

ISO / ISO enlarger, glassfiber reinforced polyamide, colour grey

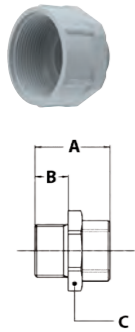

OUTSIDE THREAD	INSIDE THREAD	MIN. INTERNAL BORE (MM)	DIMENSIONS IN MM					STANDARD PACKAGE	ARTICLE NUMBER	WEIGHT (KG/100)
			A	B	C	D	E			
M12 x 1,5	M16 x 1,5	-	19	8	20	-	-	50	266.512.0	0,2
M16 x 1,5	M20 x 1,5	-	20	8	24	-	-	50	266.516.0	0,3
M20 x 1,5	M25 x 1,5	-	22	9	30	-	-	50	266.520.0	0,5
M25 x 1,5	M32 x 1,5	-	24	10	36	-	-	20	266.525.0	0,7
M32 x 1,5	M40 x 1,5	-	26	11	44	-	-	20	266.532.0	1
M40 x 1,5	M50 x 1,5	-	28	12	55	-	-	20	266.540.0	1,5
M50 x 1,5	M63 x 1,5	-	32	13	70	-	-	10	266.550.0	2,9

ISO / ISO reducer, glassfiber reinforced polyamide, colour grey

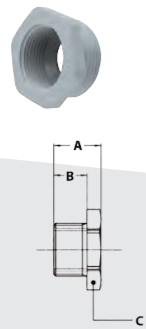

OUTSIDE THREAD	INSIDE THREAD	MIN. INTERNAL BORE (MM)	DIMENSIONS IN MM					STANDARD PACKAGE	ARTICLE NUMBER	WEIGHT (KG/100)
			A	B	C	D	E			
M16 x 1,5	M12 x 1,5	-	8	6	20	-	-	50	266.416.0	0,1
M20 x 1,5	M16 x 1,5	-	9	7	24	-	-	50	266.420.0	0,2
M25 x 1,5	M20 x 1,5	-	10	8	30	-	-	50	266.425.0	0,3
M32 x 1,5	M25 x 1,5	-	11	9	36	-	-	20	266.432.0	0,6
M40 x 1,5	M32 x 1,5	-	12	10	44	-	-	20	266.440.0	0,9
M50 x 1,5	M40 x 1,5	-	13	11	55	-	-	10	266.450.0	1,5
M63 x 1,5	M50 x 1,5	-	15	13	70	-	-	5	266.463.0	2,9

Ana-Quick  
Profi

## ANA-QUICK POLYAMIDE FITTINGS, IP 65 / IP 68

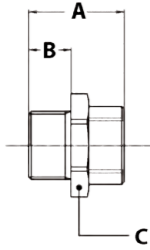
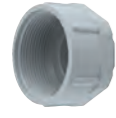

Pg / Pg enlarger, glassfiber reinforced polyamide, colour grey



OUTSIDE THREAD	INSIDE THREAD	MIN. INTERNAL BORE (MM)	DIMENSIONS IN MM					STANDARD PACKAGE	ARTICLE NUMBER	WEIGHT (KG/100)
			A	B	C	D	E			
Pg 7	Pg 9	-	20	7	19	-	-	100	266.207.0	0,3
Pg 9	Pg 11	-	23	8	22	-	-	100	266.209.0	0,4
Pg 11	Pg 13,5	-	23	8	24	-	-	100	266.211.0	0,5
Pg 16	Pg 21	-	29	9	32	-	-	100	266.216.0	1
Pg 21	Pg 29	-	32	10	42	-	-	50	266.221.0	1,4
Pg 29	Pg 36	-	36	11	53	-	-	25	266.229.0	3,6
Pg 36	Pg 42	-	41	13	60	-	-	10	266.236.0	3,8
Pg 42	Pg 48	-	41	13	65	-	-	10	266.242.0	4,4

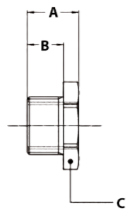

Pg / Pg reducer, glassfiber reinforced polyamide, colour grey



OUTSIDE THREAD	INSIDE THREAD	MIN. INTERNAL BORE (MM)	DIMENSIONS IN MM					STANDARD PACKAGE	ARTICLE NUMBER	WEIGHT (KG/100)
			A	B	C	D	E			
Pg 9	Pg 7	-	8	6	19	-	-	100	266.109.0	0,4
Pg 11	Pg 9	-	8	6	22	-	-	100	266.111.0	0,6
Pg 16	Pg 11	-	10	8	27	-	-	100	266.115.0	0,6
Pg 16	Pg 13,5	-	10	8	27	-	-	100	266.116.0	0,8
Pg 21	Pg 16	-	11	9	32	-	-	100	266.121.0	0,9
Pg 29	Pg 21	-	11	9	40	-	-	50	266.129.0	1,5
Pg 36	Pg 29	-	18	11	50	-	-	50	266.136.0	2,5
Pg 42	Pg 36	-	18	13	55	-	-	25	266.142.0	2,7
Pg 48	Pg 42	-	18	13	60	-	-	25	266.148.0	3,2

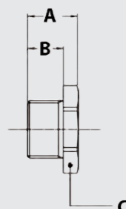

ISO plug round, glassfiber reinforced polyamide, colour black



THREAD ISO	ANA-QUICK	MIN. INTERNAL BORE (MM)	DIMENSIONS IN MM					STANDARD PACKAGE	ARTICLE NUMBER	WEIGHT (KG/100)
			A	B	C	D	E			
M12 x 1,5	-	-	8	6	16	-	-	50	269.512.0	0,02
M16 x 1,5	-	-	8	6	20	-	-	50	269.516.0	0,02
M20 x 1,5	-	-	11	8	26	-	-	50	269.520.0	0,02
M25 x 1,5	-	-	11	8	32	-	-	20	269.525.0	0,03
M32 x 1,5	-	-	14	10	40	-	-	20	269.532.0	0,04
M40 x 1,5	-	-	14	10	48	-	-	20	269.540.0	0,05
M50 x 1,5	-	-	17	12	55	-	-	10	269.550.0	0,06
M63 x 1,5	-	-	18	12	70	-	-	5	269.563.0	0,08

## ANA-QUICK POLYAMIDE FITTINGS, IP 65 / IP 68

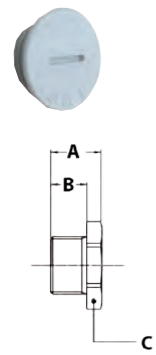

ISO plug round, glassfiber reinforced polyamide, colour grey



THREAD ISO	ANA-QUICK	MIN. INTERNAL BORE (MM)	DIMENSIONS IN MM					STANDARD PACKAGE	ARTICLE NUMBER	WEIGHT (KG/100)
			A	B	C	D	E			
M12 x 1,5	-	-	8	6	16	-	-	50	266.612.0	0,02
M16 x 1,5	-	-	8	6	20	-	-	50	266.616.0	0,02
M20 x 1,5	-	-	11	8	26	-	-	50	266.620.0	0,02
M25 x 1,5	-	-	11	8	32	-	-	20	266.625.0	0,03
M32 x 1,5	-	-	14	10	40	-	-	20	266.632.0	0,04
M40 x 1,5	-	-	14	10	48	-	-	20	266.640.0	0,05
M50 x 1,5	-	-	17	12	55	-	-	10	266.650.0	0,06
M63 x 1,5	-	-	18	12	70	-	-	5	266.663.0	0,08

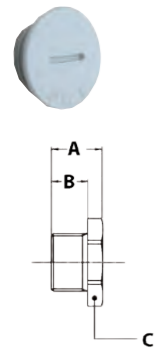

Pg plug round, glassfiber reinforced polyamide, colour grey



THREAD PG	ANA-QUICK	MIN. INTERNAL BORE (MM)	DIMENSIONS IN MM					STANDARD PACKAGE	ARTICLE NUMBER	WEIGHT (KG/100)
			A	B	C	D	E			
Pg 7	-	-	8	6	15	-	-	50	266.707.0	0,02
Pg 9	-	-	9	6	19	-	-	50	266.709.0	0,02
Pg 11	-	-	9	6	22	-	-	50	266.711.0	0,02
Pg 13,5	-	-	10	6	25	-	-	50	266.713.0	0,02
Pg 16	-	-	10	6	27	-	-	20	266.716.0	0,03
Pg 21	-	-	11	8	33	-	-	20	266.721.0	0,04
Pg 29	-	-	12	8	44	-	-	20	266.729.0	0,05
Pg 36	-	-	15	10	55	-	-	10	266.736.0	0,06
Pg 48	-	-	19	12	69	-	-	5	266.748.0	0,08



# Anamet Gigant polyamide conduit

PA6 BLACK / GREY

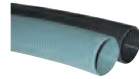

## BIG BORE FOR MEDIUM AND HIGH MECHANICAL STRENGTH

The GIGANT PA6 is applicable for standard circumstances where a bigger bore is needed. GIGANT PA6 is used in medium and heavy machines and installations in the transportation area.

### Material & Construction:

**Construction:** Corrugated conduit from modified polyamide PA6, UV resistant, halogen free.

**Temperature:** -40 °C till +120 °C, intermittent up to +150 °C.

**Flame properties:** Flame-retarding UL-94 HB.

**Colour:** Black and grey.

**Resistant against:** Alcohol, grease, fuels, mineral oils, weak bases and weak acids.

### Classification according to NEN-EN-IEC 61386:

**Compression resistance:** Class 2, Light (320 N).

**Impact resistance:** Class 2, Light (1 J).

**Tensile strength:** Class 2, Light (250 N).

**Protection class:** IP 67 (dust-proof, water-tight).



Normal profile "standard wall"

GIGANT		DIAMETRE		BENDING RADIUS (CL)		STANDARD CARTON		SMALL CARTON		REEL		WEIGHT
Size (dn)	Inside (mm)	Outside (mm)	Static (mm)	Dynamic (mm)	Metre	Article No. black	Metre	Article No. black	Metre	Article No. black	(kg/m)	
70	66,5	79,2	170	210	25	301.170.3	10	301.170.1	-	-	0,42	
95	91	106	225	280	25	301.199.3	10	301.199.1	-	-	0,78	

GIGANT		DIAMETRE		BENDING RADIUS (CL)		STANDARD CARTON		SMALL CARTON		REEL		WEIGHT
Size (dn)	Inside (mm)	Outside (mm)	Static (mm)	Dynamic (mm)	Metre	Article No. grey	Metre	Article No. grey	Metre	Article No. grey	(kg/m)	
70	66,5	79,2	170	210	25	301.070.3	10	301.070.1	-	-	0,42	
95	91	106	225	280	25	301.099.3	10	301.099.1	-	-	0,78	

# Anamet Gigant polyamide conduit

PP BLACK / GREY

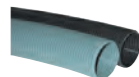

## BIG BORE FOR LOWER MECHANICAL STRENGTH

The GIGANT PP-MOD is applicable for light circumstances where a bigger bore is needed. GIGANT PP-MOD is used in light and medium machines and installations in the transportation area.

### Material & Construction:

**Construction:** Corrugated conduit from modified polypropylene (PP), UV resistant.

**Temperature:** -40 °C till +135 °C, intermittent up to +150 °C.

**Flame properties:** Self-extinguishing UL-94 V2.

**Colour:** Black and grey.

**Resistant against:** Alcohol, grease, fuels, mineral oils, weak bases and weak acids.

### Classification according to NEN-EN-IEC 61386:

**Compression resistance:** Class 1, Very Light (125 N).

**Impact resistance:** Class 1, Very Light (0,5 J).

**Tensile strength:** Class 1, Very Light (100 N).

**Protection class:** IP 67 (dust-proof, water-tight).



Normal profile "thin wall"

GIGANT Size (dn)	DIAMETRE		BENDING RADIUS (CL)		STANDARD CARTON		SMALL CARTON		REEL		WEIGHT (kg/m)
	Inside (mm)	Outside (mm)	Static (mm)	Dynamic (mm)	Metre	Article No. black	Metre	Article No. black	Metre	Article No. black	
70	66,5	79,2	170	210	25	301.370.3	10	301.370.1	-	-	0,37
95	91	106	225	280	25	301.399.3	10	301.399.1	-	-	0,605

GIGANT Size (dn)	DIAMETRE		BENDING RADIUS (CL)		STANDARD CARTON		SMALL CARTON		REEL		WEIGHT (kg/m)
	Inside (mm)	Outside (mm)	Static (mm)	Dynamic (mm)	Metre	Article No. grey	Metre	Article No. grey	Metre	Article No. grey	
70	66,5	79,2	170	210	25	301.270.3	10	301.270.1	-	-	0,37
95	91	106	225	280	25	301.299.3	10	301.299.1	-	-	0,605

Ana-Quick  
Profi

# Anamet Gigant polyamide conduit

PUR BLACK / GREY

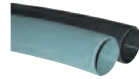

## BIG BORE FOR MEDIUM MECHANICAL STRENGTH AND HIGH FLEXIBILITY

The GIGANT PUR is applicable for standard circumstances and for frequent movements. The GIGANT PUR is used in light and medium machines, packaging-machines and the transportation area.

### Material & Construction:

**Construction:** Corrugated conduit from TPU, UV resistant, halogen free.

**Temperature:** -40 °C till +125 °C, intermittent up to +150 °C.

**Flame properties:** Flame-retarding UL-94 HB.

**Colour:** Black and grey.

**Resistant against:** Alcohol, grease, fuels, mineral oils, weak bases and weak acids.

### Classification according to NEN-EN-IEC 61386:

**Compression resistance:** Class 1, Very Light (125 N).

**Impact resistance:** Class 1, Very Light (0,5 J).

**Tensile strength:** Class 1, Very Light (100 N).

**Protection class:** IP 67 (dust-proof, water-tight).



Normal profile "standard wall"

GIGANT Size (dn)	DIAMETRE		BENDING RADIUS (CL)		STANDARD CARTON		SMALL CARTON		REEL		WEIGHT (kg/m)
	Inside (mm)	Outside (mm)	Static (mm)	Dynamic (mm)	Metre	Article No. black	Metre	Article No. black	Metre	Article No. black	
70	66,5	79,2	170	210	25	301.570.3	10	301.570.1	-	-	0,57
95	91	106	225	280	21	301.599.3	10	301.599.1	-	-	0,93

GIGANT Size (dn)	DIAMETRE		BENDING RADIUS (CL)		STANDARD CARTON		SMALL CARTON		REEL		WEIGHT (kg/m)
	Inside (mm)	Outside (mm)	Static (mm)	Dynamic (mm)	Metre	Article No. grey	Metre	Article No. grey	Metre	Article No. grey	
70	66,5	79,2	170	210	25	301.470.3	10	301.470.1	-	-	0,57
95	91	106	225	280	25	301.499.3	10	301.499.1	-	-	0,93

# Ana-Quick polyamide fittings,

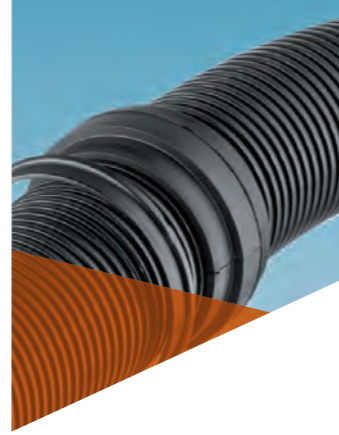

## ANA-QUICK GIGANT POLYAMIDE FLANGE FITTINGS

The polyamide Ana-Quick GIGANT fittings can be used with all types of Ana-Quick GIGANT. The design of the Ana-Quick GIGANT fitting offers good protection in combination with a high pull out strength.

### Material & Construction:

**Construction:** Flange fitting with 2 shelves and locking ring.

**Material:** Completely made from Polyamide PA6, halogen free.

**Temperature:** -30 °C till +120 °C continuous.

**Protection class:** IP 54 (dust-protected, splash-water proof).

**Colour:** Black and grey.

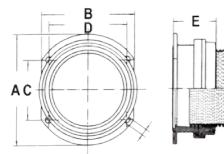
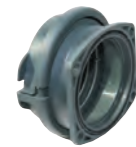

GIGANT straight flange fitting, colour black, male, PA6, IP 54 (with 4 fixing holes Ø 6,5 mm)



ANA-QUICK GIGANT SIZE (DN)	MIN. INTERNAL BORE (MM)	DIMENSIONS IN MM					STANDARD PACKAGE	ARTICLE NUMBER	WEIGHT (KG/100)
		A	B	C	D	E			
70	-	112	95	60	80	43	25	269.170.3	9,6
95	-	145	126	74	108	51	25	269.199.3	18,6

GIGANT straight flange fitting, colour grey, male, PA6, IP 54 (with 4 fixing holes Ø 6,5 mm)



ANA-QUICK GIGANT SIZE (DN)	MIN. INTERNAL BORE (MM)	DIMENSIONS IN MM					STANDARD PACKAGE	ARTICLE NUMBER	WEIGHT (KG/100)
		A	B	C	D	E			
70	-	112	95	60	80	43	25	269.070.3	9,6
95	-	145	126	74	108	51	25	269.099.3	18,6

## ANA-QUICK POLYAMIDE FITTINGS, IP 65 / IP 68

GIGANT 90° elbow flange fitting, colour black, male, PA6, IP 54  
(with 4 fixing holes Ø 6,5 mm)

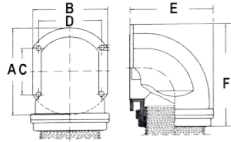

ANA-QUICK GIGANT SIZE (DN)	DIMENSIONS IN MM						STANDARD PACKAGE	ARTICLE NUMBER	WEIGHT (KG/100)
	A	B	C	D	E	F			
70	112	95	60	80	107	134	10	269.370.3	18,1
95	145	126	74	108	143	173	10	269.399.3	38,1

GIGANT 90° elbow flange fitting, colour grey, male, PA6, IP 54  
(with 4 fixing holes Ø 6,5 mm)



ANA-QUICK GIGANT SIZE (DN)	DIMENSIONS IN MM						STANDARD PACKAGE	ARTICLE NUMBER	WEIGHT (KG/100)
	A	B	C	D	E	F			
70	112	95	60	80	107	134	10	269.270.3	18,1
95	145	126	74	108	143	173	10	269.299.3	38,1

Gigant, conduit connector, grey, PA6, IP 65

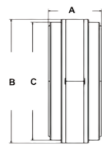

ANA-QUICK GIGANT SIZE (DN)	MIN. INTERNAL BORE (MM)	DIMENSIONS IN MM					STANDARD PACKAGE	ARTICLE NUMBER	WEIGHT (KG/100)
		A	B	C	D	E			
70	-	100	93	45	-	-	10	269.150.0	-
95	-	130	124	56	-	-	10	269.160.0	-

Gigant, conduit connector, black, PA6, IP 65



ANA-QUICK GIGANT SIZE (DN)	MIN. INTERNAL BORE (MM)	DIMENSIONS IN MM					STANDARD PACKAGE	ARTICLE NUMBER	WEIGHT (KG/100)
		A	B	C	D	E			
70	-	100	93	45	-	-	10	269.250.0	-
95	-	130	124	56	-	-	10	269.260.0	-

Gigant, conduit holder, black, PA6



ANA-QUICK GIGANT SIZE (DN)	MIN. INTERNAL BORE (MM)	DIMENSIONS IN MM					STANDARD PACKAGE	ARTICLE NUMBER	WEIGHT (KG/100)
		A	B	C	D	E			
70	-	-	-	-	-	-	10	269.130.0	-
95	-	-	-	-	-	-	10	269.140.0	-

Gigant, conduit holder, with clip, black, PA6



ANA-QUICK GIGANT SIZE (DN)	MIN. INTERNAL BORE (MM)	DIMENSIONS IN MM					STANDARD PACKAGE	ARTICLE NUMBER	WEIGHT (KG/100)
		A	B	C	D	E			
70	-	-	-	-	-	-	10	269.230.0	-
95	-	-	-	-	-	-	10	269.240.0	-

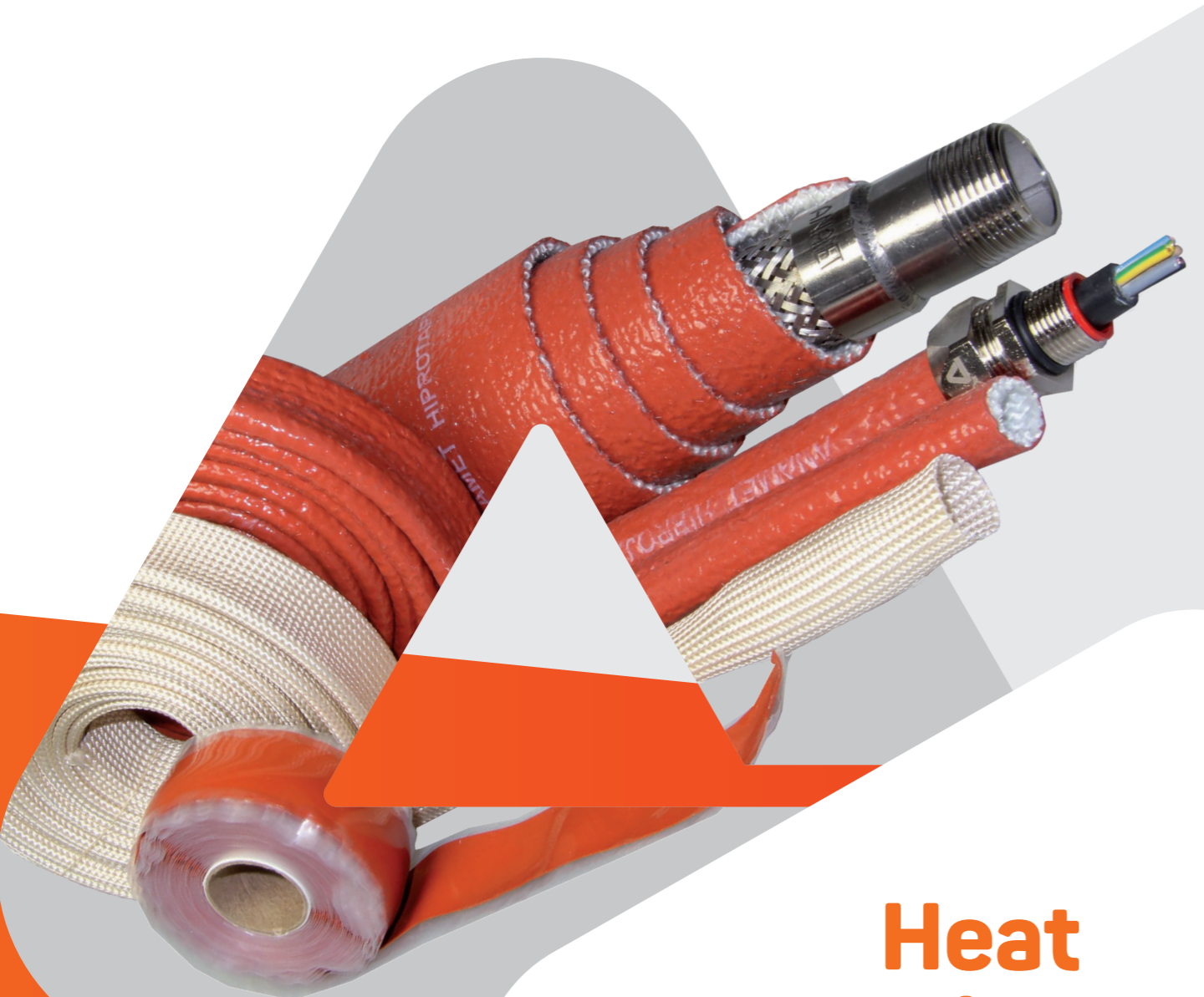

# Heat protection products

Heat protection  
products



# Product selection table

## Anamet heat protection products

PRODUCT	MATERIAL	MATERIAL	TEMPERATURE CONTINUE		TEMPERATURE SHORT TERM		RESISTANCE		APPROVALS	PAGE
			Min.	Max.	20 min.	15-30 sec.	Oil	Splash		
<b>Hiprojacket Aero</b>	Glass fibre	Silicone Halogen free RoHS	-55 °C	+260 °C	+800 °C	+1640 °C	++++	++++	 	10 - 4 till 10 - 5
<b>Hiprojacket Industrial</b>	Glass fibre	Silicone Halogen free RoHS	-55 °C	+260 °C	+800 °C	+1640 °C	++++	++++		10 - 6 till 10 - 7
<b>Hiprojacket Light</b>	Glass fibre	Silicone Halogen free RoHS	-55 °C	+260 °C	+538 °C	+1200 °C	++++	++		10 - 10
<b>Hiprosiltape</b>	Silicone	Silicone Halogen free RoHS	-55 °C	+260 °C	-	-	++++	++		10 - 11
<b>Hiprotape</b>	Glass fibre	Silicone Halogen free RoHS	-55 °C	+260 °C	+800 °C	+1640 °C	++++	++++		10 - 12 till 10 - 13
<b>Hiproblanket Wrap H</b>	Glass fibre	Silicone Halogen free RoHS	-55 °C	+260 °C	+800 °C	+1640 °C	++++	++++		10 - 14 till 10 - 15
<b>Hiproblanket Wrap M</b>	Glass fibre	Silicone Halogen free RoHS	-55 °C	+230 °C	+800 °C	+1640 °C	++++	++		10 - 16
<b>Hiproblanket Wrap Light</b>	Glass fibre	Silicone Halogen free RoHS	-55 °C	+260 °C	+538 °C	+1200 °C	++++	++		10 - 17
<b>Thermojacket</b>	Glass fibre saturated	-	-55 °C	+538 °C	-	-	-	-		10 - 18
<b>Silicajacket</b>	Silica fibre	-	-55 °C	+980 °C	-	-	-	-		10 - 22
<b>Basaltjacket</b>	Knitted basalt yarn	-	-260 °C	+750 °C	-	+980 °C	-	-		10 - 23
<b>Hiproblanket Heavy</b>	Glass fibre	Silicone Halogen free RoHS	-55 °C	+260 °C	+800 °C	+1640 °C	++++	++++		10 - 24
<b>Hiproblanket Medium</b>	Glass fibre	Silicone Halogen free RoHS	-55 °C	+260 °C	+800 °C	+1640 °C	++++	++++		10 - 25
<b>Hiproblanket Medium Aluminum</b>	Glass fibre	Aluminum	-55 °C	+200 °C	600 °C	-	-	-		10 - 27
<b>Hiproblanket Light</b>	Glass fibre	Silicone Halogen free RoHS	-55 °C	+260 °C	+800 °C	+1200 °C	++++	++		10 - 28
<b>Silicablanket</b>	Silica fibre	-	-55 °C	+1090 °C	-	-	-	-		10 - 29

# Hipro products engineering data

## Heat protection products

The right choice of heat protection materials is important for the functioning and durability of the equipment.

The choice of which product offers the best solution is strongly depending on the exact application.

The heat protection materials of Anamet Europe B.V. can basically be divided into 3 groups:

Thermo- and Silica-products don't withstand open flame exposure and molten splash, like the Hipro-products do.

1. Hipro-products, consisting of an E-glass fibre base, covered with iron-oxide silicon rubber.  
Temperature range: -55 °C till +260 °C continuous, +800 °C for approx. 20 minutes and +1640 °C for 15 - 30 seconds  
Flammability: UL-94 V1.
2. Thermo-products, consisting completely of E-glass fibre.  
Temperature range: -55 °C till +538 °C continuous.
3. Silica-products consisting of completely amorphous silica fibres. Temperature range: -55 °C till +1090 °C continuous. Each product groups are available in various grades and executions, like sleeving, tape, blankets and remountable wraps.

At the other hand Thermo-and Silica-products offer a good heat protection at higher continuous temperatures than are possible for Hipro-products.

Next to the temperature resistance, there is also a difference in insulation characteristics for the Hipro- and Thermo-products, as shown in the graph below. If however a higher level of insulation is required please refer to page 31 where we have our special high temperature insulation wraps shown.

## Thermal protection - hot side versus cold side (Temp. in °C)

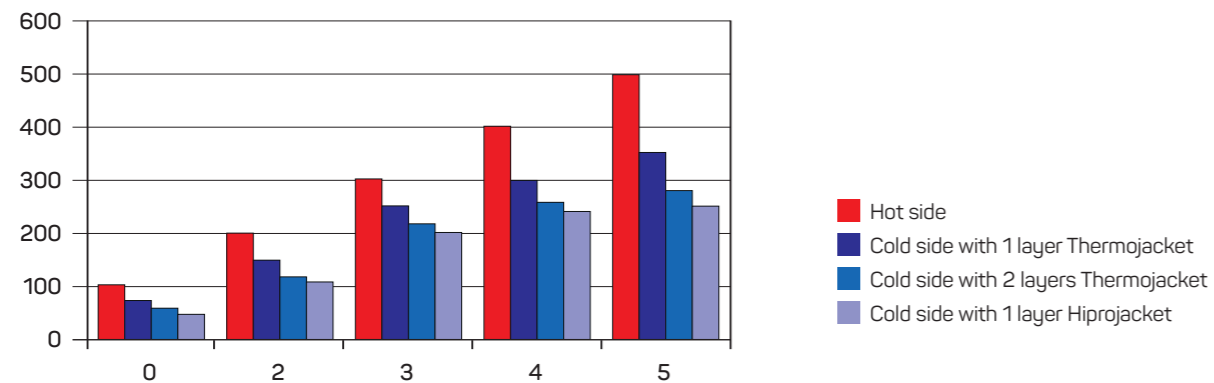

Note: Above mentioned values are based on respectively Hiprojacket Aero and Thermo jacket S (saturated) with the heat source at the inside of the sleeving. For additional information on specific conditions, please contact your Anamet representative.

When Hipro products exposed to flame, the silicone rubber transforms into crust, creating a protective SiO<sub>2</sub> refractory layer. Hipro products withstands repeated exposures to molten steel, molten aluminum and molten glass up to +1650 °C.

The heavy coating of our proprietary iron oxide red silicone compound sheds molten metal splashes immediately, so very little heat transfer occurs.



The fibre glass will not burn, retains 75% of its tensile at 343 °C, softens at 732 °C till 877 °C and melts at 1121 °C till 1182 °C.

The theoretical dielectric strength of our Hipro products is 16.000 V per mm cover thickness, being the characteristic of Silicone rubber. However as the liquid process, to coat the sleeveings, tapes and blankets, allows for possible inclusions of tiny airbubbles or pinholes we cannot guarantee a minimum dielectric strength of the finished product.

# Hiprojacket Aero red



## BRAIDED SLEEVING, SOLID CONSTRUCTED ACC. SAE AS1072, SUPERIOR SHORT TERM FLAME PROTECTION

The ultimate heat protection for cables and hoses. This solid braided glassfiber sleeving, with thick silicone cover, is constructed according to the Aerospace Standard SAE AS1072 and allows qualified hose assemblies to pass the AS1055 testing. This Hiprojacket offers superior short term flame protection and excellent temperature reduction. In the field of cable protection, a complete program of Hiprojacket fittings is available for easy installation. Resistant to hydraulic fluids, lubricating oils and fuels, Hiprojacket protects against molten splash, occasional flames, heat radiation, energy loss in piping and hoses; also protects employees from burns. Hiprojacket is typically used in the Aerospace-industry, steelworks, glass and ceramics industry, as well as in the machine- and apparatus-building.

### Material & Construction:

**Construction:** Braided sleeving from E-glass yarns, solid constructed according Aerospace Standard SAE AS1072 type 2.

**Cover specifications:** Iron-oxide silicon rubber. Excellent oil resistant, halogen free, superior short term flame protection, excellent temperature reduction and withstands molten splash.

### Special approvals:

- Highly flameretardant acc. DIN 5510-2: S4 / SR2 / ST2.
- Flameretardant acc. UNI CEI 11170-3.
- NF EN ISO 11925-2 (15 and 30 sec.).

- EN 45545-2; R22 and R23 HL1 / HL2 / HL3, (CIT<sub>nlp</sub> = 0,02 , D<sub>s</sub> max = 70 and LOI = 40,1).

- Allows qualified hose assemblies to pass the SAE AS1055 testing.

**Temperature:** -55 °C till +260 °C continuous.

- Under flame till +800 °C for approx. 20 minutes.

- Radiation heat till +800 °C for approx. 20 minutes.

- Molten metal splash till +1640 °C for 15 - 30 seconds.

**Colour:** Red, other colours available on demand.



HIPROJACKET AERO			DIAMETRE		STANDARD CARTON		SMALL CARTON*		RANDOM LENGTH		WEIGHT
Size (mm)	Size (inch)	Type	Inside (mm)	Outside (mm)	Metre	Article No. red	Metre	Article No. red	Metre	Article No. red	(kg/m)
6	1/4"	HJ-04	6	11	30	336.006.3	15	336.006.1	1	336.006.0	0,12
10	3/8"	HJ-06	10	15	30	336.010.3	15	336.010.1	1	336.010.0	0,16
13	1/2"	HJ-08	13	18	30	336.013.3	15	336.013.1	1	336.013.0	0,19
16	5/8"	HJ-10	16	22	30	336.016.3	15	336.016.1	1	336.016.0	0,21
19	3/4"	HJ-12	19	25	30	336.019.3	15	336.019.1	1	336.019.0	0,24
22	7/8"	HJ-14	22	28	30	336.022.3	15	336.022.1	1	336.022.0	0,28
25	1"	HJ-16	25	31	30	336.025.3	15	336.025.1	1	336.025.0	0,33
29	1.1/8"	HJ-18	29	35	30	336.029.3	15	336.029.1	1	336.029.0	0,35
32	1.1/4"	HJ-20	32	38	30	336.032.3	15	336.032.1	1	336.032.0	0,39
35	1.3/8"	HJ-22	35	41	30	336.035.3	15	336.035.1	1	336.035.0	0,45
38	1.1/2"	HJ-24	38	44	30	336.038.3	15	336.038.1	1	336.038.0	0,48
41	1.5/8"	HJ-26	41	47	30	336.041.3	15	336.041.1	1	336.041.0	0,52
44	1.3/4"	HJ-28	44	50	30	336.044.3	15	336.044.1	1	336.044.0	0,64
51	2"	HJ-32	51	57	30	336.051.3	15	336.051.1	1	336.051.0	0,67
57	2.1/4"	HJ-36	57	63	30	336.057.3	15	336.057.1	1	336.057.0	0,74
64	2.1/2"	HJ-40	64	70	30	336.064.3	15	336.064.1	1	336.064.0	0,75
70	2.3/4"	HJ-44	70	76	30	336.070.3	15	336.070.1	1	336.070.0	0,88
76	3"	HJ-48	76	82	30	336.076.3	15	336.076.1	1	336.076.0	1,03
83	3.1/4"	HJ-52	83	89	30	336.083.3	15	336.083.1	1	336.083.0	1,13
89	3.1/2"	HJ-56	89	95	30	336.089.3	15	336.089.1	1	336.089.0	1,18
95	3.3/4"	HJ-60	95	101	30	336.095.3	15	336.095.1	1	336.095.0	1,34
102	4"	HJ-64	102	108	30	336.102.3	15	336.102.1	1	336.102.0	1,41

\* In the 15 meter packaging it is possible that 2 lengths (totally 15 meter) are packed (minimum shortest length 4,5 meter).

## HIPROJACKET AERO



Braided sleeving, solid constructed acc. SAE AS1072,  
superior short term flame protection



HIPROJACKET AERO			DIAMETRE		STANDARD CARTON		SMALL CARTON		RANDOM LENGTH		WEIGHT
Size (mm)	Size (inch)	Type	Inside (mm)	Outside (mm)	Metre	Article No. black	Metre	Article No. black	Metre	Article No. black	(kg/m)
13	1/2"	HJ-08	13	18	30	346.913.3	-	-	-	-	0,19
16	5/8"	HJ-10	16	22	30	346.916.3	-	-	-	-	0,21
19	3/4"	HJ-12	19	25	30	346.919.3	-	-	-	-	0,24
29	1.1/8"	HJ-18	29	35	30	346.929.3	-	-	-	-	0,35
35	1.3/8"	HJ-22	35	41	30	346.935.3	-	-	-	-	0,45
38	1.1/2"	HJ-24	38	44	30	346.938.3	-	-	-	-	0,48
41	1.5/8"	HJ-26	41	47	30	346.941.3	-	-	-	-	0,52
51	2"	HJ-32	51	57	30	346.951.3	-	-	-	-	0,67

# Hiprojacket Industrial red



## KNITTED SLEEVING, GOOD SHORT TERM FLAME PROTECTION

The industrial alternative for less demanding situations. This Industrial Grade has a more open construction of glass fibre, but due to the thick silicon cover still offers good short term flame protection and temperature reduction. Resistant to hydraulic fluids, lubricating oils and fuels, Hiprojacket Industrial protects against molten splash, occasional flames, heat radiation, energy loss in piping and hoses; also protects employees from burns. Hiprojacket Industrial is frequently used to protect cables and industrial rubber or metal hoses in the glass, ceramics and steel industry, as well as in the machine- and apparatus-building.

### Material & Construction:

**Construction:** Knitted sleeving from E-glass yarns.

**Cover specifications:** Iron-oxide silicon rubber, excellent oil resistant, halogen free, good short term flame protection, good temperature reduction and withstands molten splash.

**Temperature:** -55 °C till +260 °C continuous.

- Under flame till +800 °C for approx. 20 minutes.

- Radiation heat till +800 °C for approx. 20 minutes.

- Molten metal splash till +1640 °C for 15 - 30 seconds.

**Colour:** Red, other colours available on demand.



HIPROJACKET INDUSTRIAL			DIAMETRE		STANDARD CARTON		SMALL CARTON		RANDOM LENGTH		WEIGHT
Size (mm)	Size (inch)	Type	Inside (mm)	Outside (mm)	Metre	Article No. red	Metre	Article No. red	Metre	Article No. red	(kg/m)
6	1/4"	HJ-I-04	6	11	30	336.806.3	-	-	-	-	0,11
10	3/8"	HJ-I-06	10	15	30	336.810.3	-	-	-	-	0,14
13	1/2"	HJ-I-08	13	18	30	336.813.3	-	-	-	-	0,17
16	5/8"	HJ-I-10	16	22	30	336.816.3	-	-	-	-	0,22
19	3/4"	HJ-I-12	19	25	30	336.819.3	-	-	-	-	0,25
22	7/8"	HJ-I-14	22	28	30	336.822.3	-	-	-	-	0,26
25	1"	HJ-I-16	25	31	30	336.825.3	-	-	-	-	0,3
29	1.1/8"	HJ-I-18	29	35	30	336.829.3	-	-	-	-	0,34
32	1.1/4"	HJ-I-20	32	38	30	336.832.3	-	-	-	-	0,36
35	1.3/8"	HJ-I-22	35	41	30	336.835.3	-	-	-	-	0,48
38	1.1/2"	HJ-I-24	38	44	30	336.838.3	-	-	-	-	0,53
41	1.5/8"	HJ-I-26	41	47	30	336.841.3	-	-	-	-	0,53
44	1.3/4"	HJ-I-28	44	50	30	336.844.3	-	-	-	-	0,55
51	2"	HJ-I-32	51	57	30	336.851.3	-	-	-	-	0,62
57	2.1/4"	HJ-I-36	57	63	30	336.857.3	-	-	-	-	0,71
64	2.1/2"	HJ-I-40	64	70	30	336.864.3	-	-	-	-	0,73
70	2.3/4"	HJ-I-44	70	76	30	336.870.3	-	-	-	-	0,82
76	3"	HJ-I-48	76	82	30	336.876.3	-	-	-	-	0,93
83	3.1/4"	HJ-I-52	83	89	30	336.883.3	-	-	-	-	1,14
89	3.1/2"	HJ-I-56	89	95	30	336.889.3	-	-	-	-	1,15
95	3.3/4"	HJ-I-60	95	100	30	336.895.3	-	-	-	-	1,17
102	4"	HJ-I-64	102	108	30	336.897.3	-	-	-	-	1,22
114	4.1/2"	HJ-I-72	114	120	30	336.898.3	15	336.898.1	-	-	1,65
127	5"	HJ-I-80	127	133	30	336.899.3	15	336.899.1	-	-	1,71

## HIPROJACKET INDUSTRIAL VARIOUS COLOURS



Knitted sleeving, good short term flame protection

HIPROJACKET INDUSTRIAL			DIAMETRE		STANDARD CARTON		SMALL CARTON		RANDOM LENGTH		WEIGHT
Size (mm)	Size (inch)	Type	Inside (mm)	Outside (mm)	Metre	Article No. black	Metre	Article No. black	Metre	Article No. black	(kg/m)
13	1/2"	HJ-I-08	13	18	30	346.313.3	-	-	-	-	0,17
16	5/8"	HJ-I-10	16	22	30	346.316.3	-	-	-	-	0,22
19	3/4"	HJ-I-12	19	25	30	346.319.3	-	-	-	-	0,25
29	1 1/8"	HJ-I-18	29	35	30	346.329.3	-	-	-	-	0,34
35	1 3/8"	HJ-I-22	35	41	30	346.335.3	-	-	-	-	0,48
41	1 5/8"	HJ-I-26	41	47	30	346.341.3	-	-	-	-	0,53
51	2"	HJ-I-32	51	57	30	346.351.3	-	-	-	-	0,62



HIPROJACKET INDUSTRIAL			DIAMETRE		STANDARD CARTON		SMALL CARTON		RANDOM LENGTH		WEIGHT
Size (mm)	Size (inch)	Type	Inside (mm)	Outside (mm)	Metre	Article No. grey	Metre	Article No. grey	Metre	Article No. grey	(kg/m)
13	1/2"	HJ-I-08	13	18	30	346.013.3	-	-	-	-	0,17
16	5/8"	HJ-I-10	16	22	30	346.016.3	-	-	-	-	0,22
19	3/4"	HJ-I-12	19	25	30	346.019.3	-	-	-	-	0,25
29	1 1/8"	HJ-I-18	29	35	30	346.029.3	-	-	-	-	0,34
35	1 3/8"	HJ-I-22	35	41	30	346.035.3	-	-	-	-	0,48
41	1 5/8"	HJ-I-26	41	47	30	346.041.3	-	-	-	-	0,53
51	2"	HJ-I-32	51	57	30	346.051.3	-	-	-	-	0,62

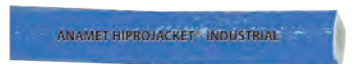

HIPROJACKET INDUSTRIAL			DIAMETRE		STANDARD CARTON		SMALL CARTON		RANDOM LENGTH		WEIGHT
Size (mm)	Size (inch)	Type	Inside (mm)	Outside (mm)	Metre	Article No. blue	Metre	Article No. blue	Metre	Article No. blue	(kg/m)
13	1/2"	HJ-I-08	13	18	30	346.113.3	-	-	-	-	0,17
16	5/8"	HJ-I-10	16	22	30	346.116.3	-	-	-	-	0,22
19	3/4"	HJ-I-12	19	25	30	346.119.3	-	-	-	-	0,25
29	1 1/8"	HJ-I-18	29	35	30	346.129.3	-	-	-	-	0,34
35	1 3/8"	HJ-I-22	35	41	30	346.135.3	-	-	-	-	0,48
41	1 5/8"	HJ-I-26	41	47	30	346.141.3	-	-	-	-	0,53
51	2"	HJ-I-32	51	57	30	346.151.3	-	-	-	-	0,62



HIPROJACKET INDUSTRIAL			DIAMETRE		STANDARD CARTON		SMALL CARTON		RANDOM LENGTH		WEIGHT
Size (mm)	Size (inch)	Type	Inside (mm)	Outside (mm)	Metre	Article No. yellow	Metre	Article No. yellow	Metre	Article No. yellow	(kg/m)
13	1/2"	HJ-I-08	13	18	30	346.213.3	-	-	-	-	0,17
16	5/8"	HJ-I-10	16	22	30	346.216.3	-	-	-	-	0,22
19	3/4"	HJ-I-12	19	25	30	346.219.3	-	-	-	-	0,25
29	1 1/8"	HJ-I-18	29	35	30	346.229.3	-	-	-	-	0,34
35	1 3/8"	HJ-I-22	35	41	30	346.235.3	-	-	-	-	0,48
41	1 5/8"	HJ-I-26	41	47	30	346.241.3	-	-	-	-	0,53
51	2"	HJ-I-32	51	57	30	346.251.3	-	-	-	-	0,62

Heat protection products



# Fittings for Hiprojacket, IP 67

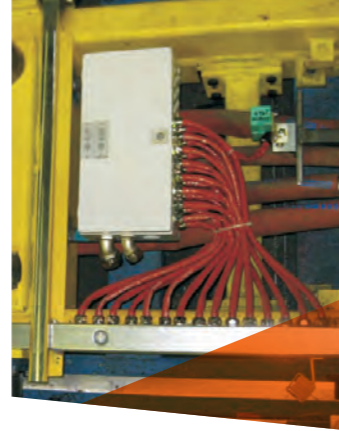

## ANACONDA NICKEL PLATED BRASS FITTINGS FOR HIPROJACKET®

Anaconda standard fittings are made from nickel plated brass and also designed to be used in combination with Hiprojacket. These are basically the same fittings as for Anaconda Sealtite conduit. The difference is that the standard polyamide clamping rings are replaced by a special metal clamping ring.

### Material & Construction:

**Construction:** Nickel plated brass fitting, consisting of 4 parts (counter nut, clamping ring, ferrule and body).

**Material:** Counter nut, body, clamping ring and ferrule are nickel plated brass with exception of size 3/8" till 1" where the ferrule is from galvanised steel. Inserts are made from PA6 (red for ISO metric, blue for Pg and white for NPT).

**Temperature:** -45 °C till +105 °C continuous (cable-hose fittings till +300 °C on request).

**Protection class:** IP 54 (dust-protected, splash water-proof), additionally sealed with Hiprosiltape, IP 67 is possible.

**Colour:** Metal.



Clamping ring, zinc plated brass, for combination with Hiprojacket



Size (mm)	HIPROJACKET TYPE		FITTING THREAD SIZE			STANDARD PACKAGE	ARTICLE NUMBER	WEIGHT (KG/100)
	Aero	Ind.	ISO	Pg	NPT			
13/10	HJ-08	HJ-I-06	M16 x 1,5	Pg 11	1/2" NPT	10	817.512.0	0,6
16/13	HJ-10	HJ-I-08	M20 x 1,5	Pg 16	1/2" NPT	10	817.516.0	0,6
22/19	HJ-14	HJ-I-12	M25 x 1,5	Pg 21	3/4" NPT	5	817.520.0	1
25	HJ-16	HJ-I-16	M32 x 1,5	Pg 29	1" NPT	5	817.526.0	1,2
35/32	HJ-22	HJ-I-20	M40 x 1,5	Pg 36	1 1/4" NPT	2	817.535.0	2
38	HJ-24	HJ-I-24	M50 x 1,5	Pg 42	1 1/2" NPT	2	817.540.0	4,2
51	HJ-32	HJ-I-32	M63 x 1,5	Pg 48	2" NPT	2	817.550.0	9

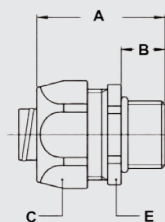

ISO straight fitting, male, nickel plated brass (without clamping ring)



THREAD ISO	HIPROJACKET TYPE		DIMENSIONS IN MM					STANDARD PACKAGE	ARTICLE NUMBER	WEIGHT (KG/100)
	Aero	Ind.	A	B	C	D	E			
M16 x 1,5	HJ-08	HJ-I-06	35	12	26	-	24	10	812.016.1	4,7
M20 x 1,5	HJ-10	HJ-I-08	37	13	29	-	27	10	812.020.1	5,1
M25 x 1,5	HJ-14	HJ-I-12	40	15	35	-	33	5	812.025.1	11,7
M32 x 1,5	HJ-16	HJ-I-16	46	15	45	-	43	5	812.032.1	19,7
M40 x 1,5	HJ-22	HJ-I-20	52	16	54	-	52	2	812.040.1	35
M50 x 1,5	HJ-24	HJ-I-24	56	18	63	-	60	2	812.050.1	42,2
M63 x 1,5	HJ-32	HJ-I-32	66	20	77	-	74	2	812.063.1	52,8

## FITTINGS FOR HIPOJACKET, IP 67

ISO cable-hose fitting, with extended clamping range, male, nickel plated brass (without clamping ring)

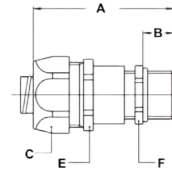

THREAD ISO	HIPOJACKET		CLAMPING RANGE (MM)	DIMENSIONS IN MM					STANDARD PACKAGE	ARTICLE NUMBER	WEIGHT (KG/100)
	Aero	Ind.		A	B	C	E	F			
M16 x 1,5	HJ-08	HJ-I-06	3 - 10,2	64	12	26	24	20	10	812.716.2	8,2
M20 x 1,5	HJ-10	HJ-I-08	7 - 13,9	64	12	29	27	24	10	812.720.2	10,2
M25 x 1,5	HJ-14	HJ-I-12	9 - 18,0	77	15	35	33	30	5	812.725.2	17
M32 x 1,5	HJ-16	HJ-I-16	13 - 23,8	88	15	45	43	40	5	812.732.2	31
M40 x 1,5	HJ-22	HJ-I-20	20 - 31,8	102	15	54	52	50	2	812.740.2	54,6
M50 x 1,5	HJ-24	HJ-I-24	21 - 36,8	106	18	63	60	58	2	812.750.2	76,6
M63 x 1,5	HJ-32	HJ-I-32	27 - 44,0	116	18	77	74	68	2	812.763.2	116,6

# Hiprojacket Light red



## LIGHTWEIGHT SLEEVING, MODERATE THERMAL PROTECTION

The most economic alternative for less demanding situations. This Light Grade has a thinner construction of glass fibre and silicone rubber cover, but due to the thin silicon cover offers some short term flame protection and a small temperature reduction. Resistant to hydraulic fluids, lubricating oils and fuels, Hiprojacket Light offers limited protection against molten splash and occasional flames. Hiprojacket Light is frequently used to protect cables and wires in the machine- and apparatus-building.

### Material & Construction:

**Construction:** Knitted sleeving from E-glass yarns.

**Cover specifications:** Iron-oxide silicon rubber. Excellent oil resistant, halogen free, limited short term flame protection, limited temperature reduction.

**Temperature:** -55 °C till +260 °C continuous.

- Under flame till +538 °C for approx. 20 minutes.
- Radiation heat till +538 °C for approx. 20 minutes.
- Molten metal splash till +1200 °C for 15 - 30 seconds.

**Colour:** Red.



HIPROJACKET LIGHT			DIAMETRE		STANDARD CARTON		SMALL CARTON		RANDOM LENGTH		WEIGHT
Size (mm)	Size (inch)	Type	Inside (mm)	Outside (mm)	Metre	Article No. red	Metre	Article No. red	Metre	Article No. red	(kg/m)
4	5/32"	HJ-L-02	4	6	100	355.004.5	-	-	-	-	0,01
6	1/4"	HJ-L-04	6	8	100	355.006.5	-	-	-	-	0,02
8	5/16"	HJ-L-05	8	10	100	355.008.5	-	-	-	-	0,03
10	3/8"	HJ-L-06	10	12	100	355.010.5	-	-	-	-	0,03
12	1/2"	HJ-L-08	12	14	100	355.012.5	-	-	-	-	0,04
16	5/8"	HJ-L-10	16	18	50	355.016.5	-	-	-	-	0,06
20	3/4"	HJ-L-12	20	22	50	355.020.5	-	-	-	-	0,08

# Hiprosiltape red / black



## TAPE FROM SELF-FUSING SILICONE RUBBER

Hiprosiltape is specially formulated to adhere to itself and is used to seal the ends of Hiprojacket and Hiprotape. Neatly applied over the transition from the Hiprojacket / Hiprotape to the surface of the hose or conduit being protected, the self-fusing tape provides a cohesive moisture resistant barrier. Conforming smoothly when wrapped around even complex shapes, the tape bonds at room temperature into a single inseparable layer after 24 hours. The product remains non-tacky to touch and is inherently flame retardant, providing a superior alternative to the standard band clamp.

### Material & Construction:

**Construction:** Unsupported silicone rubber tape, self-fusing, ideal to seal-off.

**Cover specifications:** Self-fusing silicon rubber, excellent oil resistant, halogen free, inherently flame-retardant.

**Temperature:** -55 °C till +260 °C continuous.

**Colour:** Red & black, on request also available in other colours.



HIPROSILTAPE			DIAMETRE		STANDARD CARTON		SMALL CARTON		RANDOM LENGTH		WEIGHT
Size (mm)	Size (inch)	Type	Width (mm)	Thickness (mm)	Metre	Article No. red	Metre	Article No. red	Metre	Article No. red	(kg/m)
25	1"	HST-16	25	0,5	11	337.525.1	-	-	-	-	0,02
38	1.1/2"	HST-24	38	0,3	11	337.538.1	-	-	-	-	0,04



HIPROSILTAPE			DIAMETRE		STANDARD CARTON		SMALL CARTON		RANDOM LENGTH		WEIGHT
Size (mm)	Size (inch)	Type	Width (mm)	Thickness (mm)	Metre	Article No. black	Metre	Article No. black	Metre	Article No. black	(kg/m)
25	1"	HSTB-16	25	0,5	11	337.425.1	-	-	-	-	0,02
38	1.1/2"	HSTB-24	38	0,3	11	337.438.1	-	-	-	-	0,04

Heat protection products

# Hiprotape red



## TAPE FROM WOVEN FIBERGLASS YARNS, WITH RED IRON-OXIDE SILICON RUBBER

Hiprotape provides the same heat protection as Hiprojacket Industrial Grade, in the form of a band which can be wrapped around already installed cables, hoses and valves. Resistant to hydraulic fluids, lubricating oils and fuels, Hiprotape protects against molten splash, occasional flames, energy loss in piping and hoses; also protects employees from burns; allows "bundling" of wires, hoses and cables. Hiprotape is applicable to larger diameters pipe and allows installation in situations where it is impractical or impossible to disassemble existing cable and hose assemblies. Typically used in the glass, ceramics and steel industry, as well as in the machine- and apparatus-building.

### Material & Construction:

**Construction:** Woven tape from E-glass yarns.

**Cover specifications:** Iron-oxide silicon rubber, excellent oil resistant, halogen free, good short term flame protection, good temperature reduction and withstands molten splash.

**Temperature:** -55 °C till +260 °C continuous.

- Under flame till +800 °C for approx. 20 minutes.
- Radiation heat till +800 °C for approx. 20 minutes.
- Molten metal splash till +1640 °C for 15 - 30 seconds.

**Colour:** Red.



HIPROTAPE			DIAMETRE		STANDARD CARTON		SMALL CARTON		RANDOM LENGTH		WEIGHT
Size (mm)	Size (inch)	Type	Width (mm)	Thickness (mm)	Metre	Article No. red	Metre	Article No. red	Metre	Article No. red	(kg/m)
25	1"	HT-1	25	3	30	337.025.3	15	337.025.1	-	-	0,07
51	2"	HT-2	51	3	30	337.050.3	15	337.050.1	-	-	0,18
76	3"	HT-3	76	3	30	337.076.3	15	337.076.1	-	-	0,26
102	4"	HT-4	102	3	30	337.100.3	15	337.100.1	-	-	0,4
127	5"	HT-5	127	3	30	337.127.3	15	337.127.1	-	-	0,47

# Hiprotape light grey



## TAPE FROM WOVEN FIBERGLASS YARNS, WITH THIN DOUBLE LAYER OF SILICON RUBBER

Hiprotape Light is the economical version of Hiprotape for less demanding applications. This tape can be wrapped around already installed cables, hoses and valves. Resistant to hydraulic fluids, lubricating oils and fuels, Hiprotape Light provides limited protection against molten splash and occasional flames. Typically used in machine- and apparatus-building.

### Material & Construction:

**Construction:** Woven tape from E-glass yarns.

**Cover specifications:** Silicon rubber, double-sided, excellent oil resistant, halogen free, limited short term flame protection, limited temperature reduction, withstands small particles of molten splash.

**Temperature:** -55 °C till +260 °C continuous.

- Under flame till +538 °C for approx. 20 minutes.
- Radiation heat till +538 °C for approx. 20 minutes.
- Molten metal splash till +1200 °C for 15 - 30 seconds.

**Colour:** Grey.



HIPROTAPE LIGHT			DIAMETRE		STANDARD CARTON		SMALL CARTON		RANDOM LENGTH		WEIGHT
Size (mm)	Size (inch)	Type	Width (mm)	Thickness (mm)	Metre	Article No. grey	Metre	Article No. grey	Metre	Article No. grey	(kg/m)
25	1"	HT-L-1	25	1	15	337.625.1	-	-	30	337.625.3	0,028
51	2"	HT-L-2	51	1	15	337.650.1	-	-	30	337.650.3	0,056
76	3"	HT-L-3	76	1	15	337.676.1	-	-	30	337.676.3	0,12
102	4"	HT-L-4	102	1	15	337.699.1	-	-	30	337.699.3	0,14



# Hiproblanket Wrap Heavy red



## BLANKET FROM WOVEN GLASS FIBRE YARNS, WITH RED IRON-OXIDE SILICON RUBBER AND HOOK & LOOP CLOSURE

The heatprotection of Hiproblanket in a split retro-fit form for quick installation on existing cables and hoses. Resistant to hydraulic fluids, lubricating oils and fuels, Hiproblanket Wrap protects against molten splash, occasional flames, energy loss in piping and hoses; also protects employees from burns; allows "bundling" of wires, hoses and cables. Hiproblanket Wrap is standard available up to 95 mm in diameter and allows quick installation on site without the need to dismantle and reconnect fittings. Also repair of existing installations can be performed with a minimum of labor and downtime. Typically used in the basic glass, ceramics and steel industry.

### Material & Construction:

**Construction:** Remountable sleeve from woven E-glass blanket, with polyester hook & loop closure.

**Cover specifications:** Iron-oxide silicon rubber, excellent oil resistant, halogen free, good short term flame protection, good temperature reduction, withstands molten splash.

**Weight material:** 3,26 kg/m<sup>2</sup>

**Temperature:** -55 °C till +260 °C continuous.

- Under flame till +800 °C for approx. 20 minutes.

- Radiation heat till +800 °C for approx. 20 minutes.

- Molten metal splash till +1640 °C for 15 - 30 seconds.

**Temperature Wrap closure:** +110 °C continuous. For higher temperatures additional securing with hiprosiltape is recommended.

**Colour:** Red.



HIPOBLANKET WRAP H			DIAMETRE		RANDOM LENGTH		SMALL CARTON		REELS		WEIGHT
Size (mm)	Size (inch)	Type	Inside (mm)	Outside (mm)	Metre	Article No. red	Metre	Article No. red	Metre	Article No. red	(kg/m)
25	1"	HBW-H-16	25	32	1	336.525.0	15	336.525.1	45	336.525.6	0,41
32	1.1/4"	HBW-H-20	32	39	1	336.532.0	15	336.532.1	45	336.532.6	0,48
38	1.1/2"	HBW-H-24	38	45	1	336.538.0	15	336.538.1	45	336.538.6	0,54
44	1.3/4"	HBW-H-28	44	51	1	336.544.0	15	336.544.1	45	336.544.6	0,6
51	2"	HBW-H-32	51	58	1	336.551.0	15	336.551.1	45	336.551.6	0,66
57	2.1/4"	HBW-H-36	57	64	1	336.557.0	15	336.557.1	45	336.557.6	0,73
64	2.1/2"	HBW-H-40	64	71	1	336.564.0	15	336.564.1	45	336.564.6	0,8
70	2.3/4"	HBW-H-44	70	77	1	336.570.0	15	336.570.1	45	336.570.6	0,86
76	3"	HBW-H-48	76	83	1	336.576.0	15	336.576.1	45	336.576.6	0,93
83	3.1/4"	HBW-H-52	83	90	1	336.583.0	15	336.583.1	45	336.583.6	1
89	3.1/2"	HBW-H-56	89	96	1	336.589.0	15	336.589.1	45	336.589.6	1,06
95	3.3/4"	HBW-H-60	95	102	1	336.595.0	15	336.595.1	45	336.595.6	1,12

# Hiproblanket Wrap Heavy red with turnbuckles

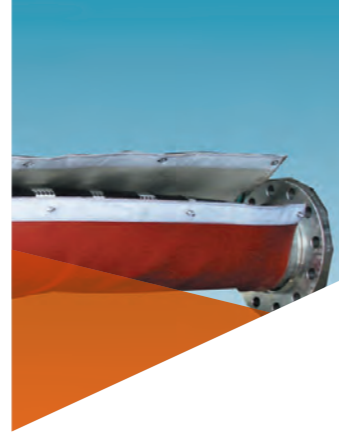

## BLANKET FROM WOVEN GLASS FIBRE YARNS, WITH RED IRON-OXIDE SILICON RUBBER, HOOK & LOOP CLOSURE AND TURNBUCKLES

The heatprotection of Hiproblanket in a split retro-fit form for quick installation on existing cables and hoses. Resistant to hydraulic fluids, lubricating oils and fuels, Hiproblanket Wrap with turnbuckles protects against molten splash, occasional flames, energy loss in piping and hoses; also protects employees from burns; allows "bundling" of wires, hoses and cables. Hiproblanket Wrap with turnbuckles is standard available up to 305 mm in diameter and allows quick installation on site without the need to dismantle and reconnect fittings. Also repair of existing installations can be performed with a minimum of labor and downtime. Typically used in the basic glass, ceramics and steel industry.

### Material & Construction:

**Construction:** Remountable sleeve from woven E-glass blanket, with polyester hook & loop closure and with at every 30 cm an additional nickel plated brass turnbuckle.

**Cover specifications:** Iron-oxide silicon rubber, excellent oil resistant, halogen free, good short term flame protection, good temperature reduction, withstands molten splash.

**Weight material:** 3,26 kg/m<sup>2</sup>

**Temperature:** -55 °C till +260 °C continuous.

- Under flame till +800 °C for approx. 20 minutes.
- Radiation heat till +800 °C for approx. 20 minutes.
- Molten metal splash till +1640 °C for 15 - 30 seconds.

**Temperature Wrap closure:** +110 °C continuous.

For higher temperatures additional securing with hiprosiltape is recommended.

**Colour:** Red.



HIPOBLANKET WRAP H - TB			DIAMETRE		RANDOM LENGTH		SMALL CARTON		REELS		WEIGHT
Size (mm)	Size (inch)	Type	Inside (mm)	Outside (mm)	Metre	Article No. red	Metre	Article No. red	Metre	Article No. red	(kg/m)
102	4"	HBW-HTB-64	102	109	1	336.940.0	15	336.940.1	45	336.940.6	1,29
114	4.1/2"	HBW-HTB-72	114	121	1	336.945.0	15	336.945.1	45	336.945.6	1,41
127	5"	HBW-HTB-80	127	134	1	336.950.0	15	336.950.1	45	336.950.6	1,55
140	5.1/2"	HBW-HTB-88	140	147	1	336.955.0	15	336.955.1	45	336.955.6	1,68
152	6"	HBW-HTB-96	152	159	1	336.960.0	15	336.960.1	45	336.960.6	1,8
165	6.1/2"	HBW-HTB-104	165	172	1	336.965.0	15	336.965.1	45	336.965.6	1,93
178	7"	HBW-HTB-112	178	185	1	336.970.0	15	336.970.1	45	336.970.6	2,07
191	7.1/2"	HBW-HTB-120	191	198	1	336.975.0	15	336.975.1	45	336.975.6	2,2
203	8"	HBW-HTB-128	203	210	1	336.980.0	15	336.980.1	45	336.980.6	2,32
216	8.1/2"	HBW-HTB-136	216	223	1	336.985.0	15	336.985.1	45	336.985.6	2,45
229	9"	HBW-HTB-144	229	236	1	336.990.0	15	336.990.1	45	336.990.6	2,59
241	9.1/2"	HBW-HTB-152	241	248	1	336.991.0	15	336.991.1	45	336.991.6	2,71
254	10"	HBW-HTB-160	254	261	1	336.992.0	15	336.992.1	45	336.992.6	2,84
267	10.1/2"	HBW-HTB-168	267	274	1	336.994.0	15	336.994.1	45	336.994.6	2,98
279	11"	HBW-HTB-176	279	286	1	336.996.0	15	336.996.1	45	336.996.6	3,1
292	11.1/2"	HBW-HTB-184	292	299	1	336.998.0	15	336.998.1	45	336.998.6	3,24
305	12"	HBW-HTB-192	305	312	1	336.999.0	15	336.999.1	45	336.999.6	3,37

# Hiproblanket Wrap Medium red



## BLANKET FROM WOVEN GLASS FIBRE YARNS, WITH RED IRON-OXIDE SILICON RUBBER AND METAL HOOK & LOOP CLOSURE

The Hiproblanket Medium in a split retro-fit form is an economical solution for quick installation on existing cables and hoses. Resistant to hydraulic fluids, lubricating oils and fuels, Hiproblanket Medium Wrap provides protection against molten splash, occasional flames; allows "bundling" of wires, hoses and cables. Due to the strong design of Hiproblanket Wrap Medium with a metal hook and aramid fleece allows quick installation on site without the need to dismantle and reconnect fittings. Also repair of existing installations can be performed with a minimum of labour and downtime. Typically used in the basic industry.

### Material & Construction:

**Construction:** Remountable sleeve from glass fibre yarns.

**Cover specifications:** Silicon rubber, single-sided, excellent oil resistant, halogen free, limited short term flame protection, good temperature reduction, withstands small particles of molten splash. The hook is made from stainless steel and the loop is from aramid fleece material.

**Weight material:** 2,00 kg/m<sup>2</sup>.

**Temperature:** -55 °C till +230 °C continuous.

- Under flame till +800 °C for approx. 20 minutes.
- Radiation heat till +800 °C for approx. 20 minutes.
- Molten metal splash till +1640 °C for 15 - 30 seconds.

**Temperature hook and loop:** -55 °C till +300 °C continuous. Radiation heat till +500 °C for approx. 20 minutes.

**Colour:** Red.



HIPOBLANKET WRAP M			DIAMETRE		RANDOM LENGTH		SMALL CARTON		REELS		WEIGHT
Size (mm)	Size (inch)	Type	Inside (mm)	Outside (mm)	Metre	Article No. red	Metre	Article No. red	Metre	Article No. red	(kg/m)
32	1.1/4"	HBW-MM-20	32	39	-	-	15	356.732.3	-	-	0,48
38	1.1/2"	HBW-MM-24	38	40	-	-	15	356.738.3	-	-	0,54
51	2"	HBW-MM-32	51	53	-	-	15	356.751.3	-	-	0,66
76	3"	HBW-MM-48	76	78	-	-	15	356.776.3	-	-	0,93
102	4"	HBW-MM-64	102	104	-	-	15	356.799.3	-	-	1,12

# Hiproblanket Wrap Light grey

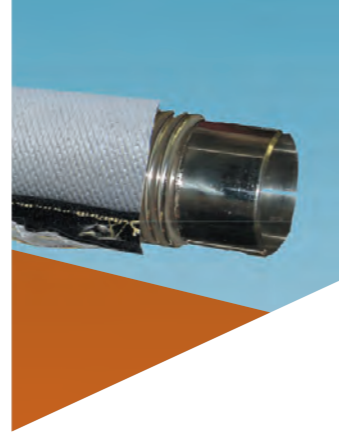

## BLANKET FROM WOVEN GLASS FIBRE YARNS, WITH THIN DOUBLE LAYER OF SILICON RUBBER AND HOOK & LOOP CLOSURE

The Hiproblanket Light in a split retro-fit form is an economical solution for quick installation on existing cables and hoses. Resistant to hydraulic fluids, lubricating oils and fuels, Hiproblanket Wrap Light provides limited protection against molten splash, occasional flames; allows "bundling" of wires, hoses and cables. Hiproblanket Wrap Light allows quick installation on site without the need to dismantle and reconnect fittings. Also repair of existing installations can be performed with a minimum of labor and downtime. Typically used in the basic industry.

### Material & Construction:

**Construction:** Remountable sleeve from glass fibre yarns.

**Cover specifications:** Silicon rubber, double-sided, excellent oil resistant, halogen free, limited short term flame protection, limited temperature reduction, withstands small particles of molten splash.

**Weight material:** 1,1 kg/m<sup>2</sup>.

**Temperature:** -55 °C till +260 °C continuous.

- Under flame till +538 °C for approx. 20 minutes.

- Radiation heat till +538 °C for approx. 20 minutes.

- Molten metal splash till +1200 °C for 15 - 30 seconds.

**Temperature Wrap closure:** +110 °C continuous. For higher temperatures additional securing with hiprosiltape is recommended.

**Colour:** Grey.



HIPOBLANKET WRAP L			DIAMETRE		RANDOM LENGTH		SMALL CARTON		REELS		WEIGHT
Size (mm)	Size (inch)	Type	Inside (mm)	Outside (mm)	Metre	Article No. grey	Metre	Article No. grey	Metre	Article No. grey	(kg/m)
25	1"	HBW-L-16	25	27	1	337.725.0	15	337.725.1	30	337.725.3	0,02
38	1.1/2"	HBW-L-24	38	40	1	337.738.0	15	337.738.1	30	337.738.3	0,04
51	2"	HBW-L-32	51	53	1	337.751.0	15	337.751.1	30	337.751.3	0,08
64	2.1/2"	HBW-L-40	64	66	1	337.764.0	15	337.764.1	30	337.764.3	0,15
76	3"	HBW-L-48	76	78	1	337.776.0	15	337.776.1	30	337.776.3	0,2
89	3.1/2"	HBW-L-56	89	91	1	337.789.0	15	337.789.1	30	337.789.3	0,3
102	4"	HBW-L-64	102	104	1	337.799.0	15	337.799.1	30	337.799.3	0,4

# Thermojacket S



## BRAIDED SLEEVING FROM E-GLASS, WITH AN ACRYLIC SATURANT COATING

The braided glass fibre sleeving is coated with an acrylic saturant coating, which adds rigidity and abrasive strength to the hose or cable and the large braid angle allows for significant expansion of the sleeve if necessary (for instance with in-line couplings or bigger cable-splices). The material resists most acids and alkalis; is unaffected by most bleaches and solvents. In the field of cable protection, a complete program of Thermo jacket fittings is available for easy installation. Thermo jacket S does not withstand molten splash like Hipro jacket does, but offers good heat protection at higher continuous temperatures than are possible for Hipro jacket. Applications include thermal insulation and protecting of cables and hoses in the glass, ceramics and steel industry as well as in the apparatus- and machine-building industry.

### Material & Construction:

**Construction:** Braided E-glass sleeving, with acrylic saturant coating; high continuous temperature, halogen free, good thermal insulation, abrasion resistant, no end-fray, easy installation for long lengths.

**Temperature:** -55 °C till +538 °C continuous.

**Colour:** Gold.



THERMOJACKET S		DIAMETRE		STANDARD CARTON		SMALL CARTON		REELS		WEIGHT	
Size (mm)	Size (inch)	Type	Inside (mm)	Outside (mm)	Metre	Article No. gold	Metre	Article No. gold	Metre	Article No. gold	(kg/m)
4	1/4"	TJ-04	5 - 10	7 - 12	30	336.604.3	15	336.604.1	180	336.604.8	0,02
6	3/8"	TJ-06	8 - 15	10 - 17	30	336.606.3	15	336.606.1	120	336.606.8	0,04
10	5/8"	TJ-10	12 - 30	14 - 32	30	336.610.3	15	336.610.1	75	336.610.8	0,08
14	7/8"	TJ-14	20 - 50	22 - 52	30	336.614.3	15	336.614.1	60	336.614.8	0,15
22	1.3/8"	TJ-22	30 - 65	32 - 67	30	336.622.3	15	336.622.1	45	336.622.8	0,2
44	2.3/4"	TJ-44	50 - 125	52 - 127	30	336.644.3	15	336.644.1	-	-	0,3

### Special remarks:

Thermojacket S is a woven sleeve and for this reason very flexible. Due to its flexibility it can be expanded, so different sizes can be covered with one and the same type of Thermo jacket S.

Please notice that when the sleeve is expanded, more meters are necessary to cover the same length, as indicated in the table below.

- TJ-04 on 6 mm core: 1,00 metre TJ is needed to cover 1,00 metre core.
- TJ-06 on 10 mm core: 1,00 metre TJ is needed to cover 1,00 metre core.
- TJ-06 on 13 mm core: 1,25 metre TJ is needed to cover 1,00 metre core.
- TJ-10 on 16 mm core: 1,00 metre TJ is needed to cover 1,00 metre core.
- TJ-10 on 19 mm core: 1,15 metre TJ is needed to cover 1,00 metre core.
- TJ-14 on 25 mm core: 1,02 metre TJ is needed to cover 1,00 metre core.
- TJ-14 on 32 mm core: 1,08 metre TJ is needed to cover 1,00 metre core.
- TJ-22 on 38 mm core: 1,06 metre TJ is needed to cover 1,00 metre core.
- TJ-22 on 52 mm core: 1,17 metre TJ is needed to cover 1,00 metre core.
- TJ-44 on 76 mm core: 1,16 metre TJ is needed to cover 1,00 metre core.
- TJ-44 on 102 mm core: 1,51 metre TJ is needed to cover 1,00 metre core.

# Fittings for Thermojacket IP 67



## ANACONDA NICKEL PLATED BRASS FITTINGS FOR ANAMET THERMOJACKET S

To fit the Thermojacket S you can use the standard Anaconda fittings (which are being used for Sealtite), if you replace their standard polyamide clamping rings with the special metal clamping rings mentioned here under. The fittings are also available in 45° - 90° and in stainless steel (see also chapter 5).

### Material & Construction:

**Construction:** Nickel plated brass fitting, consisting of 4 parts (counter nut, clamping ring, ferrule and body).

**Material:** Counter nut, body, clamping ring and ferrule are nickel plated brass with exception of size 3/8" till 1" where the ferrule is from galvanised steel. Inserts are made from PA6 (red for ISO metric, blue for Pg and white for NPT).

**Temperature:** -45 °C till +105 °C continuous (cable-hose fittings till +300 °C on request).

**Protection class:** IP 40.

**Colour:** Metal.



Clamping ring, nickel plated brass, for combination with Thermojacket S



Size (mm)	THERMOJACKET TYPE		FITTING THREAD SIZE		STANDARD PACKAGE	ARTICLE NUMBER	WEIGHT (KG/100)	
	Aero	ISO	Pg	NPT				
6	TJ-06	-	M16 x 1,5	Pg 11	1/2" NPT	50	817.612.0*	0,6
10	TJ-10	-	M20 x 1,5	Pg 16	1/2" NPT	50	817.616.0	0,6
10	TJ-10	-	M25 x 1,5	Pg 21	3/4" NPT	25	817.620.0	1
14	TJ-14	-	M32 x 1,5	Pg 29	1" NPT	10	817.626.0	1,2
14	TJ-14	-	M40 x 1,5	Pg 36	1.1/4" NPT	5	817.635.0*	2
22	TJ-22	-	M50 x 1,5	Pg 42	1.1/2" NPT	5	817.640.0*	4,2
22	TJ-22	-	M63 x 1,5	Pg 48	2" NPT	4	817.650.0*	9

\* Please note that for the marked sizes a double layer of teflon tape or Hiprosiltape is recommended around the ferrule. This to guarantee the right pull-out strength.

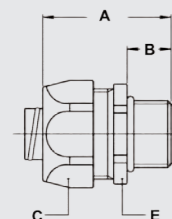

ISO straight fitting, male, nickel plated brass (without clamping ring).



THREAD ISO	HIPOJACKET		DIMENSIONS IN MM					STANDARD PACKAGE	ARTICLE NUMBER	WEIGHT (KG/100)
	Type	Int. Diam.	A	B	C	D	E			
M16 x 1,5	TJ-06	10,2	12	26	24	-	50	50	812.016.1	4,7
M20 x 1,5	TJ-10	13,9	13	29	27	-	50	50	812.020.1	5,1
M25 x 1,5	TJ-10	18,5	15	35	33	-	25	25	812.025.1	11,7
M32 x 1,5	TJ-14	23,8	15	45	43	-	10	10	812.032.1	19,7
M40 x 1,5	TJ-14	31,8	16	54	52	-	5	5	812.040.1	35
M50 x 1,5	TJ-22	36,8	18	63	60	-	5	5	812.050.1	42,2
M63 x 1,5	TJ-22	47,8	20	77	74	-	4	4	812.063.1	52,8

Heat protection products



## FITTINGS FOR THERMOJACKET IP 67

ISO cable-hose fitting, with extended clamping range, male, nickel plated brass (without clamping ring)

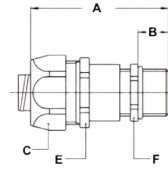

THREAD ISO	THERMOJACKET Type	CLAMPING RANGE (MM)	DIMENSIONS IN MM					STANDARD PACKAGE	ARTICLE NUMBER	WEIGHT (KG/100)
			A	B	C	E	F			
M16 x 1,5	TJ-06	3 - 10,2	64	12	26	24	20	10	812.716.2	8,2
M20 x 1,5	TJ-10	7 - 13,9	64	12	29	27	24	10	812.720.2	10,2
M25 x 1,5	TJ-10	9 - 18,0	77	15	35	33	30	5	812.725.2	17,0
M32 x 1,5	TJ-14	13 - 23,8	88	15	45	43	40	5	812.732.2	31,0
M40 x 1,5	TJ-14	20 - 31,8	102	15	54	52	50	2	812.740.2	54,6
M50 x 1,5	TJ-22	21 - 36,8	106	18	63	60	58	2	812.750.2	76,6
M63 x 1,5	TJ-22	27 - 44,0	116	18	77	74	68	2	812.763.2	116,6

# Thermojacket L



## BRAIDED SLEEVING FROM TYPE E-GLASS, NON-TREATED

The most economic solution for less demanding situations. Compared to the standard Thermo jacket, this Grade L is not heat treated, which makes it limited abrasion resistant. The material resists most acids and alkalis; is unaffected by most bleaches and solvents. Thermo jacket Grade L is especially used in static applications with moderate heat radiation, and where limited thermal insulation of cables and hoses is needed. Typical field of application is in the apparatus- and machine-building industry (for example on motors, heaters, ovens, etc.).

### Material & Construction:

**Construction:** Braided E-glass sleeving; high continuous temperature, halogen free, moderate thermal insulation, soft-flexible, light weight.

**Temperature:** -55 °C till +538 °C continuous.

**Colour:** White.



THERMOJACKET L			DIAMETRE		STANDARD CARTON		SMALL CARTON		REELS		WEIGHT
Size (mm)	Size (inch)	Type	Inside (mm)	Outside (mm)	Metre	Article No. white	Metre	Article No. white	Metre	Article No. white	(kg/m)
2	5/32"	TJ-L-02	4	5	500	357.102.8	-	-	-	-	0,01
4	1/4"	TJ-L-04	6	7	300	357.104.8	-	-	-	-	0,01
5	5/16"	TJ-L-05	8	9	300	357.105.8	-	-	-	-	0,01
6	3/8"	TJ-L-06	10	11	300	357.106.8	-	-	-	-	0,02
8	1/2"	TJ-L-08	12	13	200	357.108.8	-	-	-	-	0,02
10	5/8"	TJ-L-10	15	16	200	357.110.8	-	-	-	-	0,02
12	3/4"	TJ-L-12	20	21	100	357.112.8	-	-	-	-	0,03
16	1"	TJ-L-16	25	26	100	357.116.8	-	-	-	-	0,03
18	1.1/8"	TJ-L-18	30	31	100	357.118.8	-	-	-	-	0,04
22	1.3/8"	TJ-L-22	34	35	50	357.122.8	-	-	-	-	0,06

# Silicajacket

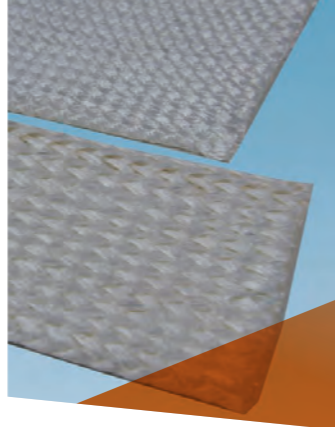

## BRAIDED SLEEVING FROM SILICA FIBRES

In cases of higher temperatures than the standard Thermo jacket, Silicajacket is the solution as heat protection for cables and hoses. Thanks to the natural rigidity the Silicajacket is easy to apply over long lengths of hose or cable and the large braid angle allows for significant expansion of the sleeve if necessary (for instance with in-line couplings or bigger cable-splices). The material resists most acids and alkalis; is unaffected by most bleaches and solvents. Silicajacket does not withstand molten splash like Hipro jacket does, but offers good heat protection at higher continuous temperatures than are possible for Hipro jacket and Thermo jacket. Applications include thermal insulation and protecting of cables and hoses in the glass, ceramics and steel industry as well as in the apparatus- and machine-building industry. In case a higher abrasion is needed it is possible to supply Silicajacket with a Vermiculite coating. Also available completely made from ceramic fibres for temperatures up to +1260 °C continuous.

### Material & Construction:

**Construction:** Braided sleeving from amorphous silica fibres, high continuous temperature, halogen free, good thermal insulation, easy installation for long lengths. The resistance to acids is fair and to most alkalis is good. Silicajacket has a high resistance against bleaches and solvents.

**Temperature:** -55 °C till +980 °C continuous.

**Colour:** White.



SILICAJACKET			DIAMETRE		STANDARD CARTON		SMALL CARTON		REELS		WEIGHT
Size (mm)	Size (inch)	Type	Inside (mm)	Outside (mm)	Metre	Article No. white	Metre	Article No. white	Metre	Article No. white	(kg/m)
16	1"	SJ-16	25	27	15	347.016.1	-	-	-	-	0,008
24	1.1/2"	SJ-24	38	40	15	347.024.1	-	-	-	-	0,015
32	2"	SJ-32	50	52	15	347.032.1	-	-	-	-	0,02
48	3"	SJ-48	75	77	15	347.048.1	-	-	-	-	0,03
64	4"	SJ-64	100	102	15	347.064.1	-	-	-	-	0,04

# Basaltjacket



## KNITTED SLEEVING FROM BASALT YARN

This high temperature knitted sleeve is constructed of 100% basalt yarn, which provides excellent thermal protection and will withstand continuous exposure to temperatures of up to +750°C. When installed on vehicle exhaust tubes and pipes, the sleeve facilitates retention of high temperatures as gases flow through the exhaust system.

The durable, knitted design is very flexible, which enables ease of assembly over tubes and pipes with bends and flanges. The dense single wall construction provides optimal coverage. The heavy duty construction, which is more than 15% denser than market average and minimizes snagging and tearing of the sleeve during assembly. The sleeves are available in precut lengths or continuous lengths of up to 150 meter (depending on size), which permits the user to cut the sleeves to exact lengths to adapt to specific requirements. Typical applications include automotive, heavy-duty truck, and bus exhaust tubes and pipes and high temperature industrial applications to protect hoses and cables.

### Material & Construction:

**Construction:** Knitted basalt yarn.

**Chemical resistance:** Resists most acids and alkalis and is unaffected by most bleaches and solvents.

**Operating temperature:** -260 °C till +750 °C continuous, +980°C short term.

**Colour:** Gold.



BASALTJACKET			DIAMETRE		STANDARD CARTON		SMALL CARTON		REELS		WEIGHT
Size (mm)	Size (inch)	Type	Inside (mm)	Outside (mm)	Metre	Article No. gold	Metre	Article No. gold	Metre	Article No. gold	(kg/m)
25	1"	BJ-16	25	30	152	347625.6	30	347625.3	-	-	0,20
38	1.1/2"	BJ-24	38	43	91	347638.6	30	347638.3	-	-	0,26
51	2"	BJ-32	51	56	76	347651.6	30	347651.3	-	-	0,32
64	2.1/2"	BJ-40	64	69	68	347664.6	30	347664.3	305	347664.8	0,40
76	3"	BJ-48	76	81	61	347676.6	30	347676.3	259	347676.8	0,47
89	3.1/2"	BJ-56	89	94	53	347689.6	30	347689.3	228	347689.8	0,52
102	4"	BJ-64	102	107	50	347695.6	30	347695.3	198	347695.8	0,62
127	5"	BJ-80	127	132	38	347698.6	30	347698.3	152	347698.8	0,78

### Wire heat protection test

Wire temperature at 76 mm from a 4" exhaust tube

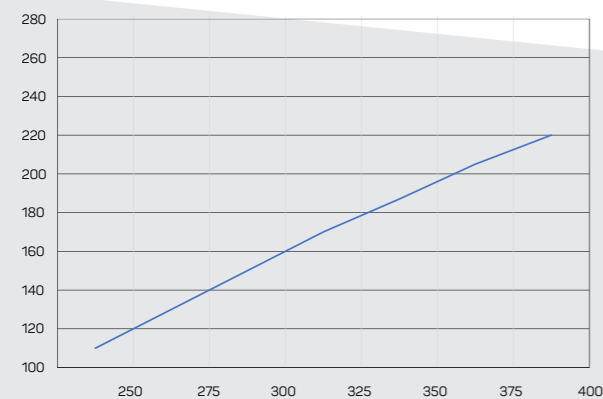

### Exhaust tube temperature °C

The information contained herein is believed to be reliable. Users should make their own evaluations on products and materials to determine the suitability for the application.

Heat protection products

# Hiproblanket Heavy red



## BLANKET FROM WOVEN GLASS FIBRE YARNS, WITH THICK LAYER OF RED IRON-OXIDE SILICON RUBBER

A woven blanket of glass fibre, backed with an excellent oil resistant silicone rubber cover, provides an effective method to shield employees and equipment from intense heat radiation and the hazards of molten splash. Supplied as a blanket from 1 meter wide by up to 45 meter long, Hiproblanket Heavy can be figured to provide protection for almost any shape. Joined to curtains, by sewing with glass fibre yarn or by connecting with stainless steel turn-buckles, Hiproblanket Heavy covers are able to shield furnace control panels, cable ladders and fettling plants. Typically used in the basic glass, ceramics and steel industry. On demand also available made from silica with a red iron oxide silicone cover.

### Material & Construction:

**Construction:** Woven blanket from E-glass yarns. **Temperature:** -55 °C till +260 °C continuous.

**Cover specifications:** Iron-oxide silicon rubber.

- Under flame till +800 °C for approx. 30 minutes.
- Radiation heat till +800 °C for approx. 20 minutes.
- Molten metal splash till +1640 °C for 15 - 30 seconds.

**Weight material:** 3,26 kg/m<sup>2</sup>.

**Colour:** Red.



HIPROBLANKET HEAVY			DIMENSIONS		RANDOM LENGTH		SMALL CARTON		REELS		WEIGHT
Size (mm)	Size (inch)	Type	Width (mm)	Thickness (mm)	Metre	Article No. red	Metre	Article No. red	Metre	Article No. red	(kg/m)
1016	40"	HB-H-3250S	1016	3	1	336.440.0	15	336.440.1	45	336.440.5	3,26

# Hiproblanket Medium red



## BLANKET FROM WOVEN GLASS FIBRE YARNS, WITH THICK LAYER OF RED IRON-OXIDE SILICON RUBBER

A woven blanket of glass fibre, backed with an excellent oil resistant silicone rubber cover, provides an effective method to shield employees and equipment from intense heat radiation and the hazards of molten splash. Supplied as a blanket from 1 meter wide by up to 50 meter long, Hiproblanket Heavy can be figured to provide protection for almost any shape. Joined to curtains, by sewing with glass fibre yarn or by connecting with stainless steel turn-buckles, Hiproblanket Heavy covers are able to shield furnace control panels, cable ladders and fettling plants. Typically used in the basic glass, ceramics and steel industry.

### Material & Construction:

**Construction:** Woven blanket from E-glass yarns. **Temperature:** -55 °C till +260 °C continuous.

**Cover specifications:** Iron-oxide silicon rubber.  
 Excellent oil resistant, halogen free, good short term flame protection, good temperature reduction, withstands molten splash.

- Under flame till +800 °C for approx. 30 minutes.
- Radiation heat till +800 °C for approx. 20 minutes.
- Molten metal splash till +1640 °C for 15 - 30 seconds.

**Weight material:** 2,00 kg/m<sup>2</sup>.

**Colour:** Red.



HIPOBLANKET MEDIUM			DIMENSIONS		RANDOM LENGTH		SMALL CARTON		REELS		WEIGHT
Size (mm)	Size (inch)	Type	Width (mm)	Thickness (mm)	Metre	Article No. red	Metre	Article No. red	Metre	Article No. red	(kg/m)
1000	-40"	HB-M-2000-S	1000	1,6	1	336.340.0	25	336.340.1	50	336.340.5	2



# Hiproblanket Medium red 2 sides



## BLANKET FROM WOVEN GLASS FIBRE YARNS, WITH DOUBLE SIDED A THICK LAYER OF RED IRON-OXIDE SILICON RUBBER

A woven blanket of glass fibre, with double sided an excellent oil resistant silicone rubber cover, provides an effective method to shield employees and equipment from heat radiation and particles of molten splash. Supplied as a blanket from 1,0 meter wide by up to 50 meter long, Hiproblanket Medium can be figured to provide protection for almost any shape. Especially used where lower weight is required. Hiproblanket Medium covers are able to shield hydraulic hoses and piping. Typically used in general industrial applications.

### Material & Construction:

**Construction:** Woven blanket from E-glass yarns.

**Temperature:** -55 °C till +260 °C continuous.

**Cover specifications:** Silicon rubber, double-sided, excellent oil resistant, halogen free, limited short term flame protection, good temperature reduction, withstands particles of molten splash.

- Under flame till +800 °C for approx. 20 minutes.
- Radiation heat till +800 °C for approx. 20 minutes.
- Limited molten metal splash till +1640 °C for 15 - 30 seconds.

**Weight material:** 2,6 kg/m<sup>2</sup>.

**Colour:** Red.



HIPOBLANKET MEDIUM 2 SIDES			DIMENSIONS		RANDOM LENGTH		SMALL CARTON		REELS		WEIGHT
Size (mm)	Size (inch)	Type	Width (mm)	Thickness (mm)	Metre	Article No. red	Metre	Article No. red	Metre	Article No. red	(kg/m)
1000	40"	HB-M-2600-D	1000	2	1	336.350.0	10	336.350.1	50	336.350.5	2,6

# Hiproblanket Medium aluminum 1 side

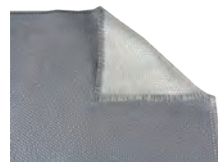

## BLANKET FROM WOVEN GLASS FIBRE YARNS, WITH SINGLE SIDED AN ALUMINUM FOIL

A woven blanket of glass fibre, backed on one sides, with an aluminum cover, provides an effective method to shield employees and equipment from limited heat radiation. Supplied as a blanket from 1 meter wide by up to 50 meter long, Hiproblanket Medium Aluminum can be figured to provide protection for almost any shape. Especially used where low weight is required. Hiproblanket Medium Aluminum has limited flame properties.

### Material & Construction:

**Construction:** Woven blanket from heat treated E-glass yarns.

**Cover specifications:** Aluminum foil, single-sided, halogen free, The cover will decompose above 200 °C, limited temperature reduction, high heat radiation.

**Weight material:** 1,10 kg/m<sup>2</sup>.

**Temperature:** -55 °C till +200 °C continuous.

Radiation heat till +600 °C for approx. 20 minutes.

**Colour:** Silver.



HIPOBLANKET MEDIUM ALUMINUM			DIMENSIONS		RANDOM LENGTH		SMALL CARTON		REELS		WEIGHT
Size (mm)	Size (inch)	Type	Width (mm)	Thickness (mm)	Metre	Article No. silver	Metre	Article No. silver	Metre	Article No. silver	(kg/m)
1000	40"	HB-AS-1100	1000	1,6	1	336.470.0	25	336.470.1	50	336.470.3	1,1

# Hiproblanket Light grey

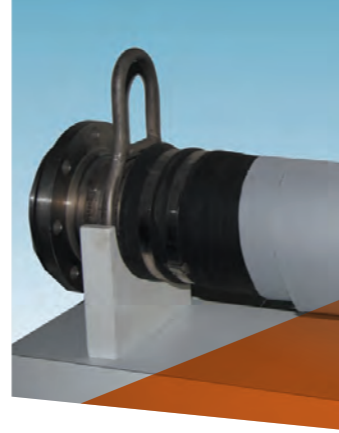
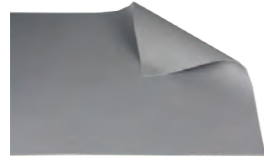

## BLANKET FROM WOVEN GLASS FIBRE YARNS, WITH THIN DOUBLE LAYER OF SILICON RUBBER

A woven blanket of glass fibre, backed on both sides, with an excellent oil resistant silicone rubber cover, provides an effective method to shield employees and equipment from limited heat radiation and small particles of molten splash. Supplied as a blanket from 1,5 meter wide by up to 45 meter long, Hioproblanket Light can be figured to provide protection for almost any shape. Especially used where low weight is required. Hioproblanket Light covers are able to shield hydraulic hoses and piping. Typically used in general industrial applications.

### Material & Construction:

**Construction:** Woven blanket from E-glass yarns.

**Temperature:** -55 °C till +260 °C continuous.

**Cover specifications:** Silicon rubber, double-sided, excellent oil resistant, halogen free, limited short term flame protection, limited temperature reduction, withstands small particles of molten splash.

- Under flame till +538 °C for approx. 30 minutes.
- Radiation heat till +800 °C for approx. 20 minutes.
- Small molten metal splash till +1200 °C for 15 - 30 seconds.

**Weight material:** 0,85 or 1,1 kg/m<sup>2</sup>.

**Colour:** Grey.



HIPOBLANKET LIGHT			DIMENSIONS		RANDOM LENGTH		SMALL CARTON		REELS		WEIGHT
Size (mm)	Size (inch)	Type	Width (mm)	Thickness (mm)	Metre	Article No. grey	Metre	Article No. grey	Metre	Article No. grey	(kg/m)
1524	60"	HB-L-1100-D	1524	1	1	336.420.0	15	336.420.1	45	336.420.5	1,1

# Silicablanket



## BLANKET FROM WOVEN SILICA YARNS

A woven blanket of silica fibre provides an effective method to shield employees and equipment from intense heat radiation. Supplied as a blanket from 0,9 metre wide by up to 50 meter long, Silicablanket can be figured to provide protection for almost any shape. The material resists most acids and alkalis; is unaffected by most bleaches and solvents. Silicablanket doesnot withstand molten splash like Hiproblanket does, but offers good heatprotection at higher continuous temperatures than are possible for Hiproblanket or Thermoblanket. Applications include thermal insulation and protection of all kinds of large surfaces and irregular shapes, in the glass, ceramics and steel industry as well as in the apparatus- and machine-building industry. Type SB1200VM has a Vermiculite coating for higher abrasion and excelent flame properties.

### Material & Construction:

**Construction:** Woven blanket from amorpheus silica yarns. High continuous temperature, halogen free, good thermal insulation.

**Weight material:** 1,35, 1,10 or 0,60 kg/m<sup>2</sup>.

**Temperature:** -55 °C till +1090 °C continuous.

**Colour:** White.



SILICABLANKET			DIMENSIONS		RANDOM LENGTH		SMALL CARTON		REELS		WEIGHT
Size (mm)	Size (inch)	Type	Width (mm)	Thickness (mm)	Metre	Article No. white	Metre	Article No. white	Metre	Article No. white	(kg/m)
880	34"	SB-600	880	0,65	1	347.430.0	-	-	50	347.430.5	0,6
930	37"	SB-1200-VM	930	1,2	1	347.420.0	-	-	50	347.420.5	1,1

# Competence in making special assemblies

The Hipro Blanket is specifically suitable to be used for heat protective assemblies.

**Curtains:** by adding rings or rails we are able to make curtains that protects areas against heat.

**Covers:** by using buckles or turn buckles we are able to construct covers for machinery or other equipment.

**Wraps:** by using hook and loops, sometimes additional enforced by turn buckles we are able to make wraps in various shapes and sizes.

**Insulation Wrap:** by using additional insulation material we are able to create insulation and heat protective wraps.

Next we are able to construct special assemblies based on specification or drawing.



# Hipro Insulation Wrap



## ASSEMBLY FROM HIPOBLANKET AND THERMOBLANKET WITH NEEDED E-GLASS FILLING

The Hipro Insulation Wrap is a combination of our Hipro and Thermo products with the aim to achieve a high level of thermal insulation in combination with short term flame protection. The outer layer of Hiproblanket Light insulation material is resistant to hydraulic fluids, lubricating oils and fuels, it protects against small particulates of molten splash, occasional flames, energy loss in piping and hoses; also protects employees from burns. The main characteristic however is that Hipro Insulation Wrap has an effective high insulation  $\lambda$ -Factor in saving energy losses from piping etc.. Hipro Insulation Wrap is a custom made product and can be made in diameters up to 302 mm. It allows quick installation in-situ without the need to dismantle and reconnect fittings. Also repair of existing installations can be performed with a minimum of labor and downtime. Typically used in the basic glass, ceramics and steel industry. On demand also available with ceramic filling.

### Material & Construction:

**Construction:** Remountable sleeve from woven E-glass blanket as innerlayer, filling of needed E-glass and silicone coated E-glass blanket outside; with polyester hook & loop closure and with at every 10 cm an additional nickel plated brass turnbuckle.

**Cover specifications:** Silicon rubber, excellent oil resistant, halogen free, limited short term flame protection, good temperature reduction,

withstands small particulates of molten splash.

**Temperature:** -55 °C till +260 °C continuous.

- Under flame till +538 °C for approx. 20 minutes.

- Radiation heat till +538 °C for approx. 20 minutes.

- Small molten metal splash till +1200 °C for 15 - 30 seconds.

**Colour:** Grey.

Hipro Insulation Wrap comes in 2 types of needed fillings with different thermal insulation characteristics:

Thermal conductivity data ( $\lambda$ )



	TYPE 1	TYPE 2
<b>TEMPERATURE / FILLING</b>	Filling 96-112 kg/m <sup>3</sup>	Filling 144-176 kg/m <sup>3</sup>
<b>AT 150 C°</b>	0,04 W / mK	0,05 W / mK
<b>AT 260 C°</b>	0,05 W / mK	0,07 W / mK
<b>AT 370 C°</b>	0,065 W / mK	0,09 W / mK

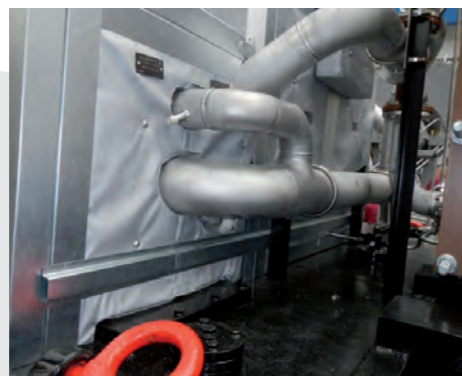

Heat protection products



# MSDS for Hipro-, Thermo and Silicajacket



## HIPRO- THERMO- AND SILICA INSTRUCTION:

The heatprotection products of Anamet Europe BV can be easily cut with a pair of scissors or a craft knife. Please note however the under mentioned safety regulations.

## SAFETY AND HEALTH PRECAUTIONS FOR HANDELING HIPRO- AND THERMO PRODUCTS

For the Hipro products there are no additional safety pre-cautions needed in addition to the Thermo products. The difference between these product groups is the silicone cover. Silicone can be classified as not dangerous. In case of E-Glass fibre, precautions under certain circumstances might be needed.

### Personal safety:

**Breath safety:** In situations where large quantities of fibre dust occur, it is advised to wear at least an European commission approved FP1 or FP2 dusk mask. We recommend using types like 3M8710 or 33M9900 or similar, being approved by the American National Institute for Occupational Safety and Health (NIOSH).

**Eye protection:** Safety glasses or mask.

**Hand protection:** Safety hand gloves.

**Body protection:** Using long sleeved clothes (shirt and trousers) in order to avoid irritation. Persons with a sensible skin are recommended to protect free falling skin areas with a protective crème.

**Instruction for labour hygiene:** The regulation as stated in TRGS 521 - glass fibre dust - as published on November 1997, Nr. 5, general statement, for fibres with a diameter larger than 3 µm which will occur during handling or machining a product, should be followed up accordingly.

### Toxicologic instructions:

**Local effects:** Short term itch possible. The itch is from mechanical art and short term, they can be applicable for skin, eyes and the upper respiration. The influence will however decrease by leaving the production area. Classification according Norm 67 / 548 / EEC is not needed as glass filaments are according Norm 97 / 69 / EC not classified as being itchy (Class Xi).

**Irritation:** Very seldom allergic reactions. The statement of allergies is given in general. In order to avoid any risk we advise to handle the products in a moist environment.

**Risk of cancer:** The high quality E-glassfibers used in the Hipro- and Thermo-products are having a diameter of more than 3 micron (typical diameter of 9 micron average) and are therefore classified as non-respirable!! This means that these fibers do not penetrate in the lower lungs. Respirable fibers are defined as "... fibers with a length of more than 5 micron, with a diameter smaller than 3 micron and a length / diameter ratio of more than 3/1 ..." (definition according to the World Health Organization).

**Details towards risk of cancer:** The fact that E-Glass fibres are a non-cancer risk are, independently from each other, stated by various official authorities. The WHO (World Health Organisation) has, through its International Cancer Investigation Centre (CIIRC), in addition to the congress in June 1987, checked all relevant laboratory tests on animals with reflection to glass fibres analysis. The results are that Glass fibres are judged as a non-risk in relation to cancer. They belong to the group MMF (Man made Mineral Fibres). The European commission has, in Norm 97 / 69 / EC, included that Glass fibres are a non-risk element and for this reason do not need any classification or labelling.

### Risk Substances:

**E-Glass fibre:** CAS-Nr.: 65977-17-3, R-Type not applicable, mass quantity 98,5 - 99 %.

**Coating:** Non-subscribed, R-Type not applicable, mass quantity 1,5 - 1,0 %.

### First aid method:

**Description first aid method:** Cleaning activities in order to remove fibres from respiration, skin and mucous membrane.

**After inhalation:** Forcing coughing by using slime developing or stimulating damp (like water damp inhalation).

**After skin contact:** Cleaning the skin by using water and soap.

**After eye contact:** Large fibres by mechanical cleaning. Small fibres by flushing water from the nose to the eye corner.

**After eating:** Meaningless.

**Instruction for first aid or medical assistance:** No specific medical treatment is needed.

**Instructions for fire fighting:** The burning gasses from glass fibres are in basic; Carbon Dioxide and water damp. It is however possible that small amounts of Carbon Monoxide and other substances will occur. In case of large fires the use of protection equipment is needed.



# General

# Anaconda conduit and fitting installation

## ANACONDA CONDUIT EASY TO INSTALL

With a large diversity of applications, usage and installation, there is a variety of possibilities for cutting, sawing of conduit. In this overview we will try to mention the most important.

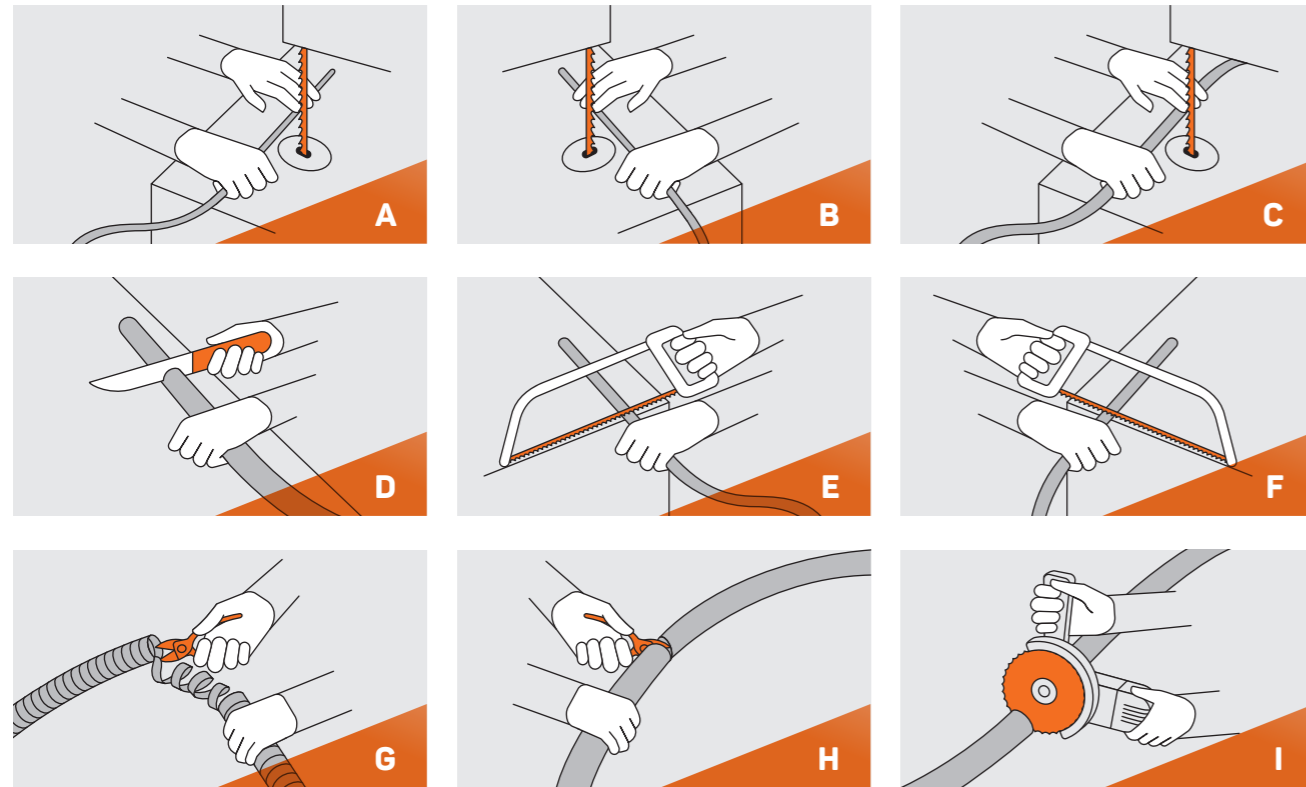

### Sawing in a production environment:

The easiest way to cut Anaconda conduit in a production environment is with a band saw. By using a 4 - 5 mm wide, 0,6 - 0,8 mm thick band.

Metal conduit "without cover" are easy to cut with a high speed band saw with 24 teeth per inch band (Fig. A).

Conduit "with cover" will need a band with about ca. 20 teeth per inch at a medium speed (Fig. B). All safety precautions should be taken care of.

For braided conduit, we advise to put a band of masking tape over the conduit before cutting, at the site of the cut, this also makes fittings easier to install (Fig. C).

For full-plastic conduits the same procedure can be used, cutting with a craft knife is also an option (Fig. D).

At larger sizes, from 1.1/2", the usage of a cutting-flex is an option (Fig. I).

### Sawing in a non-production environment:

The easiest way to cut Anaconda conduit with or without a cover, in a non-production environment is with a hacksaw (Fig. E).

Another often used method is to break the conduit (only possible with square-locked profile) and cut it with tin snips or steel shears (Fig. G and H).

For conduit "with cover", we advise to cut the cover first with a knife before breaking the conduit.

For braided conduit, we advise to put a band of masking tape over the conduit before cutting, at the site of the cut, this also makes fittings easier to install (Fig. F).

For full-plastic conduits the same procedure can be used, cutting with a craft knife is also an option.

At larger sizes, from 1.1/2", the usage of a cutting-flex is an option (Fig. I).

# Anaconda conduit and fitting installation



## INSTALLATION INSTRUCTION ANACONDA FITTINGS

For all types SEALTITE conduits (except CNP)

The Anaconda fittings are easy to install

Place the counter nut (part A) with the thread to the front over the conduit, place the plastic clamping ring (part B) over the conduit, turn the ferrule (part C) in the conduit (hand-tight), place the body (part D) and screw the counter nut hand-tight. Afterwards with a wrench 1 or 2 turns and the fitting is installed IP 66 / IP 67 liquid-tight.

## INSTALLATION INSTRUCTION ANACONDA COMPACT FOOD GRADE FITTINGS

For all types SEALTITE conduits (except CNP)



Slide the counter nut (part A), with the TPE clamping seal (part B) inside, together over the conduit, turn the ferrule (part C) in the conduit (hand-tight), place the body (part D) and screw the counter nut hand-tight. Afterwards with a wrench 1 or 2 turns till the seat of the counternut closes on the cabinet and the fitting is installed IP 68 / IP 69 liquid-tight.

## INSTALLATION INSTRUCTION FITTINGS FOR CNP

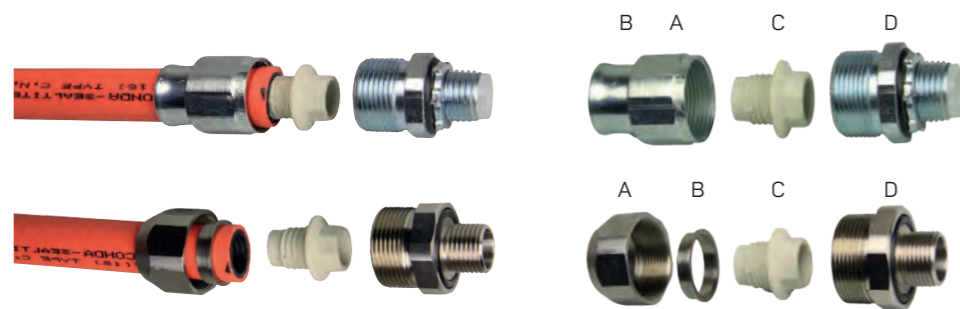

### Zinc plated steel CNP fittings

The zinc plated Anamet fittings are easy to install. Place the counter nut (part A) with integrated sleeve (part B) and the thread to the front over the conduit, turn the ferrule (part C) in the conduit (hand-tight), place the body (part D) and screw the counter nut hand-tight. Afterwards with a wrench 1 or 2 turns and the fitting is installed IP 67 liquid-tight.

### Stainless steel CNP fittings

The stainless steel Anaconda fittings are easy to install. Place the counter nut (part A) with the conduit ring (part B) and the thread to the front over the conduit, turn the ferrule (part C) in the conduit (hand-tight), place the body (part D) and screw the counter nut hand-tight. Afterwards with a wrench 1 or 2 turns and the fitting is installed IP 67 liquid-tight.

# Anaconda conduit and fitting installation











## ANACONDA FITTINGS, THE UNIVERSAL SOLUTION

### ANACONDA FITTINGS: UNIVERSAL & CORROSION RESISTANT

For the development of the Anaconda fittings a solution was sought to match all types of conduit in our program. For this reason we have decided to develop a 4 piece fitting. The construction is fully adapted to the Anaconda Sealtite conduit and guarantees an IP 67 watertight connection. In case of the cable-hose-fitting even an IP 68 can be obtained. The robust construction meets all the high UL / CSA demands. The usage of nickel plated brass guarantees a high corrosion resistance. The Anaconda fittings are available in a complete program; ISO metric Pg and NPT in straight, 45° and 90° male execution. In order to have a unified usage of the Anaconda fittings small adjustments through connection sets are necessary. Below an overview of the various conduits and their solution.

### ANACONDA FITTINGS: NICKEL PLATED BRASS

The counter nut and body are nickel plated brass, all other parts are listed below.

CONDUIT	PARTNUMBER	METHOD OF DELIVERY	MATERIAL	MATERIAL	APPROVALS	PROTECTION
Type	Last digit		Clamping ring	Ferrule		Class
<b>Multiflex FCEN</b>	.3	Standard fitting (.0 or .1) including connection set (completely assembled)	Passivated brass	Passivated brass		IP 40
<b>Multiflex SL / SLI</b>	.6	Standard fitting (.0 or .1) including connection set (completely assembled)	Nickel plated brass	Nickel plated brass		IP 40
<b>Multiflex SLB</b>	.0 or .1	Standard fitting (.0 or .1) clamping ring must be ordered additionally	Zink plated brass	Galvanised steel / nickel plated brass		IP 40
<b>Multiflex UI / UIG</b>	.7	Standard fitting (.0 or .1) including connection set (completely assembled)	Nickel plated brass	Nickel plated brass		IP 40
<b>Multitite FCD / FCE</b>	.4	Standard fitting (.0 or .1) including connection set (completely assembled)	PA6	Passivated brass		IP 65
<b>Multitite FCD / FCE</b>	.5	Standard fitting (.0 or .1) including connection set (completely assembled)	NBR rubber	Nickel plated brass		IP 68
<b>SEALTITE all (except CNP)</b>	.0 or .1	Standard fitting (.0 or .1)	PA6	Galvanised steel / nickel plated brass	  	IP 66 * IP 67
<b>SEALTITE NMUA / NMSF</b>	.0-NM	Standard fitting (.0 or .1) including special ferrule (completely assembled)	PA6	Nickel plated brass		IP 66 * IP 67
<b>Hiprojacket</b>	.0 or .1	Standard fitting (.0 or .1) clamping ring must be ordered additionally	Zinc plated brass	Galvanised steel / nickel plated brass		IP 54

Note:

All Anaconda compact fittings are IP 66 / IP 67 on the Sealtite conduit.

Special remark:

Above outlined is not applicable for ATEX fittings. In case of ATEX fittings, the connection set always must be ordered additionally.

# Anaconda conduit and fitting installation











## ANACONDA STAINLESS STEEL FITTINGS, THE UNIVERSAL SOLUTION

### ANACONDA STAINLESS STEEL FITTINGS: UNIVERSAL & EXTRA CORROSION RESISTANT

For the development of the Anaconda stainless steel fittings a solution was sought to match all types of conduit in our program. For this reason we have decided to develop a 4 piece fitting. The construction is fully adapted to the Anaconda Sealtite conduit and guarantees an IP 67 watertight connection. In case of the cable-hose fitting even an IP 68 can be obtained. The robust construction meets all the high UL / CSA demands. The usage of stainless steel guarantees a superior corrosion resistance. The Anaconda stainless steel fittings are available in a complete program; ISO metric Pg and NPT in straight, 45° and 90° male execution. In order to have a unified usage of the Anaconda fittings small adjustments through connection sets are necessary. Below an overview of the various conduits and their solution.

### ANACONDA FITTINGS: STAINLESS STEEL (AISI-304 AND AISI-316)

The counter nut and body are stainless steel (AISI-304 or AISI-316), other parts are listed below.

CONDUIT	PARTNUMBER	METHOD OF DELIVERY	MATERIAL	MATERIAL	APPROVALS	PROTECTION
Type	Last digit		Clamping ring	Ferrule		Class
<b>Multiflex SLI</b>	.96	Standard fitting (.9) including connection set (completely assembled)	Nickel plated brass stainless steel AISI-304	Nickel plated brass or stainless steel AISI-304		IP 40
<b>Multiflex SLB</b>	.9	Standard fitting (.9) clamping ring must be ordered additionally	Zinc plated brass	Nickel plated brass or stainless steel AISI-304		IP 40
<b>Multiflex UI</b>	.8	Standard fitting (.9) including connection set (completely assembled)	Nickel plated brass	Nickel plated brass		IP 40
<b>Multitite FCD / FCE</b>	.94	Standard fitting (.9) including connection set (completely assembled)	PA6 brass	Passivated brass		IP 65
<b>Multitite FCD / FCE</b>	.95	Standard fitting (.9) including connection set (completely assembled)	NBR rubber	Nickel plated brass		IP 68
<b>SEALTITE all (except CNP)</b>	.9	Standard fitting (.9)	PA6	Nickel plated brass or stainless steel AISI-304		IP 66 * IP 67
<b>SEALTITE NMUA / NMSF</b>	.9-NM	Standard fitting (.9) including special ferrule (completely assembled)	PA6	Nickel plated brass	  	IP 66 * IP 67
<b>Hiprojacket</b>	.9	Standard fitting (.9) clamping ring must be ordered additionally	Zinc plated brass	Nickel plated brass		IP 54

Note:

All Anaconda compact fittings are IP 66 / IP 67 on the Sealtite conduit.

Special remark:

Above outlined is not applicable for ATEX fittings. In case of ATEX fittings, the connection set always must be ordered additionally.



# Anaconda conduit chemical resistance

## ALL TYPES OF SEALTITE CONDUITS WITH PVC BASED COVER (TYPES EF-M, EF, OR, HC, AS, FG, HTDL, HTUA, CW, HCI, CNP, NMUA, NMSF AND NMFG)

**Legend:** 1 = Excellent  
2 = Good  
3 = Fair  
4 = Poor

The listed chemicals have been tested with results noted below.  
It is recommended that samples of conduit should be tested under actual conditions wherever possible, since results may differ from test conditions.

SUBSTANCE	RESULT	SUBSTANCE	RESULT	SUBSTANCE	RESULT
Acetate Solvents	4	Creosote	4	Methyl Acetate	4
Acetic Acid 10%	2	Cresol	3	Methyl Alcohol	3
Acetic Acid (Glacial)	3	Cresylic Acid	4	Methyl Bromide	4
Acetone	4	Cyclohexane	2	Methylene Chloride	4
Acrylonitrile	1	DDT Weed Killer	1	Methyl Ethyl Ketone	4
Alcohols (Aliphatic)	3	Dibutyl Phthalate	4	Mineral Oil	1
Aluminum Chloride	1	Diesel Oils	3	Monochlorobenzene	4
Aluminum Sulfate (Alums)	1	Diethylene Glycol	2	Muriatic Acid (see Hydrochloric Acid)	3
Ammonia (Anhydrous Liquids)	4	Diethyl Ether	1	Naphta	1
Ammonia (Aqueous)	1	Di-isodecyl Phthalate	4	Naphthalene	4
Ammoniated Latex	1	Dioctyl Phthalate	4	Nitric Acid 10%	1
Ammonium Chloride	1	Dow General Weed Killer (Phenol)	4	Nitric Acid 35%	1
Ammonium Hydroxide	1	Dow General Weed Killer (H2O)	2	Nitric Acid 70%	4
Amyl Acetate	4	Ethyl Alcohol	3	Oleum	4
Aniline Oils	4	Ethylene Dichloride	4	Oxalic Acid	1
Aromatic Hydrocarbons	4	Ethylene Glycol	2	Pentachlorophenol in Oil	2
Asphalt	4	Ferric Chloride	1	Pentane	3
ASTM Fuel A	3	Ferric Sulfate	1	Perchloroethylene	4
ASTM Fuel B	4	Ferrous Chloride	1	Petroleum Ether	3
ASTM #1 Oil	2	Ferrous Sulfate	1	Phenol	2
ASTM #3 Oil	3	Formaldehyde	4	Phosphoric Acid 85%	1
Barium Chloride	1	Fuel Oil	2	Pitch	2
Barium Sulfide	1	Furfural	3	Potassium Hydroxide	1
Barium Hydroxide	1	Gallic Acid	1	Propyl Alcohol	2
Benzene (Benzol)	4	Gasoline (Hi Test)	3	Ritchfield 'A' Weed Killer	3
Benzine (Petroleum Ether)	3	Glycerine	1	Sea Water	1
Black Liquor	1	Grease	1	Sodium Hydroxide 10%	1
Bordeaux Mixture	1	Green Sulfate Liquor	1	Sodium Hydroxide	1
Boric Acid	1	Heptachlor in Petroleum Solvents	1	Soybean Oil	3
Butyl Acetate	4	Heptane	3	Sodium Cyanide	1
Butyl Alcohol	2	Hexane	3	Stoddard Solvent	4
Calcium Hydroxide	1	Hydrobromic Acid	1	Styrene	4
Calcium Hypochlorite	1	Hydrochloric Acid 10%	1	Sulfur Dioxide (liquid)	4
Carbolic Acid (Phenol)	2	Hydrochloric Acid 40%	3	Sulfuric Acid 50%	1
Carbon Dioxide	1	Hydrofluoric Acid 70%	4	Sulfuric Acid 98%	4
Carbon Disulfide	4	Hydrofluorobonic Acid	1	Sulfurous Acid	2
Carbon Tetrachloride	4	Hydrofluorosilicic Acid	1	Tall Oil	4
Carbonic Acid	1	Hydrogen Peroxide 10%	1	Tannic Acid	1
Casein	1	Iso-octane	3	Toluene	4
Caustic Soda	1	Isopropyl Acetate	4	Trichlorethylene	4
Chlorine Gas (wet)	4	Isopropyl Alcohol	2	Triethanol Amine	3
Chlorine Gas (dry)	4	Jet Fuels (JP-3,4, and 5)	3	Tricresyl Phosphate (Skydrol)	4
Chlorine (water solution)	3	Kerosene	3	Turpentine	3
Chlorobenzene	4	Ketones	4	Vinegar	1
Chlorinated Hydrocarbons	4	Linseed Oil	1	Vinyl Chloride	4
Chromic Acid 10%	2	Lubricating Oils	1	Water	1
Citric Acid	1	Magnesium Chloride	1	White Liquor	1
Coal Tar	4	Magnesium Hydroxide	1	Xylene	4
Coconut Oil	3	Magnesium Sulfate	1	Zinc Chloride	1
Corn Oil	1	Malathion 50 in Aromatics	4	Zinc Sulfate	1
Cottonseed Oil	3	Malic Acid	1		

# Anaconda conduit chemical resistance

## ALL TYPES OF SEALTITE CONDUITS WITH POLYURETHANE COVER (TYPES HFX, HFI, HTFG, HTFGI AND ZHUA)

**Legend:** ++ = Resistant, little change in volume 0 - 3 %  
+ = Nearly resistant, change in volume 4 - 15 %  
- = Limited resistant, change in volume 16 - 30 %  
-- = Unresistant, change in volume > 30 %  
0 = Dissolving

The listed chemicals have been tested with results noted below.  
It is recommended that samples of conduit should be tested under actual conditions wherever possible, since results may differ from test conditions.

SUBSTANCE	RESULT	SUBSTANCE	RESULT	SUBSTANCE	RESULT
Acetic acid 10 %	--	Chlorobenzene	--	50 isooctane: 50 toluene	-
Acetic acid 3 %	+	Chloromethanes	--	Isopropanol	+
Acetone	--	Chromium oxides 17 %	--	Kerosene	++
Aluminium chloride 10 %	++	Citric acid 3 %	+	Lactic acid 10 %	--
Ammonia 100 %	--	Cyclohexane	+	Lactic acid 3 %	+
(=caustic soda solution)	+	Cyclohexanone	--	Lubricating greases	++
Ammonia 3 %	+	Dekalin	-	Magnesium chloride 10% & 30%	++
Ammonium chloride 3 %	++	Dichloroethanes	+	Methane	+
Aniline	--	Diesel oil	++	Methanol	+
ASTM-fuel A	++	Dimethylacetamide	0	Methyl acetate	--
ASTM-fuel B	-	Dimethylformamide	0	Mineral oil see ASTM Oil	
ASTM-fuel C	-	Ethanol 10 %	++	Nitric acid 18 %	0
ASTM-oil 1	++	Ethanol 100 %	+	N-methyl-2-pyrrolidone	0
ASTM-oil 2	++	Ethers	-	Oil of turpentine	+
ASTM-oil 3	++	Ethyl acetate	--	Ozone	++
Benzene	--	Ethylene glycol	++	Paraffin	+
= fuel 1 (DIN53 521)	++	Fluorohydrocarbons Frigen 12	-	Sodium chloride 10 %	++
Benzyl alcohol	0	Fluorohydrocarbons Frigen 22	-	Sodium hypochloride pH 13	++
Brake fluid ATE	--	Formic acid 10 %	--	Sodium sulfite 3 %	++
= fuel 2 (DIN53 521)	-	Formic acid 3 %	+	Sulfuric acid 25 %	--
Brake fluid ATS	--	Glycerol	++	Sulfuric acid 3 %	-
(sodium hypochlorite)	++	Hydrochloric acid 3 %	-	Tetrachloroethylene	-
Butane gas	+	Hydrochloric acid 10 %	--	Tetrachloromethane	-
= fuel 3 (DIN53 521)	-	Hydrogen peroxide 3 %	++	Tetrahydrofuran	0
Butanol	-	Iron-III-chloride 10 %	+	Transmission oil SAE 90	++
2-butanone	--	Isooctane		Washing lyes pH 13	++
Butyl acetate	--	Toluene	--	Water techn., sea water	++
Calcium chloride 10 %	++	70 isooctane: 30 toluene	-	Water, distilled	++
Carbon disulfide	-	Trichloroethylene	--	Xylenes	--

Remark:

Chemical resistance chart is based on a medium temperature of +23°C.

The resistance of polymeric materials to chemicals is dependent on species, induction period, temperature, quantity and concentration of the media.  
As we are not able to control the user's operating conditions, we cannot give guarantees.

# Anaconda conduit chemical resistance

## APPLIES TO ALL ANA-QUICK PROFI

**Legend:** + = Resistant  
0 = Conditionally resistant  
- = Not resistant

The listed chemicals have been tested with results noted below.  
It is recommended that samples of conduit should be tested under actual conditions wherever possible, since results may differ from test conditions.

Reagent	CONCENTRATION %	AT TEMP. + °C	POLYAMIDE			THERMOPLASTIC POLYURETHANE	POLYPROPYLENE
			PA6	PA66	PA12	PU	PP
Acetaldehyde	40	20	o	o	+		+
Acetic acid	100	20					+
Acetone	100	20	+	+	+	-	+
Acrylic acid	100	> 30	-	-	-		
Allyl alcohol	96	20	o	o	+		+
Alum, hydrous	dilute	40					+
Aluminium chloride, hydrous	dilute	40					+
Aluminium sulphate, hydrous	dilute	40					+
Ammonia solution, hydrous	saturated	20	20% +	20% +	20% +		+
Ammonium chloride, hydrous	saturated	60				3% o	+
Ammonium nitrate, hydrous	dilute	40					+
Ammonium sulphate, hydrous	dilute	40					+
Aniline hydrochloride, hydrous	saturated	20					+
Aniline, pure	100	20	o	o	o		+
Benzaldehyde, hydrous	saturated	20	pure o	pure o	pure o		+
Benzine	100	20	+	+	+		o
Benzoic acid, hydrous	any	40	20% o	20% o			+
Benzole	100	20	+	+	+		o
Bleaching liquor	12,5 Cl	20	-	-	o	3% -	+
Borax, hydrous	dilute	40					+
Boric acid, hydrous	dilute	40	o	o	o	3% o	+
Bromine, liquid	100	20	-	-	-		-
Butanediol, hydrous	to 10	20	pure +	pure +			+
Butanol	to 100	20					+
Butylacetate	100	20	+	+	+		o
Calcium chloride, hydrous	saturated	40	+	+	+		+
Carbon bisulphide	100	20	+	+	+		+
Carbon dioxide	100	60	+	+	+		
Carbon dioxide, dry	100	60					+
Carbon tetrachloride	100	20	+	+	+		-
Caustic potash solution, hydrous	50	20	+	+	+		+
Caustic soda lye, hydrous	10	20	+	+	+	3% o	+
Chlorine	any	20	-	-	-		-
Chrome alum, hydrous	dilute	40					+
Citric Acid	to 10	40	20% +	20% +	20% +	3% o	+
Cooling liquids DIN 53521		120	o	o			
Copper monochloride, hydrous	saturated	20					+
Copper sulphate, hydrous	saturated	60					+
Cresol, hydrous	to 90	20	pure -	pure -			+
Cyclohexanol	-	20	+	+	+		+
Diesel fuel		85	+	+	+	20°C +	20°C +
Drilling oil			+	+	+		
Ethanoic acid	10	20	o	o	+	3% o	+
Ethyl alcohol, hydrous	10	20	40 Vol.%+	40 Vol.%+	40 Vol.%+		+
Ethyl dichloride	100	20					o
Ethyl ether	100	20					o

The resistance of polymeric materials to chemicals is dependent on species, induction period, temperature, quantity and concentration of the media. As we are not able to control the user's operating conditions, we cannot guarantee anything.

Source Plastic Table, B. Carlowitz, Carl Hanser Verlag, and others.

# Anaconda conduit chemical resistance

## APPLIES TO ALL ANA-QUICK PROFI

**Legend:** + = Resistant  
0 = Conditionally resistant  
- = Not resistant

The listed chemicals have been tested with results noted below.  
It is recommended that samples of conduit should be tested under actual conditions wherever possible, since results may differ from test conditions.

Reagent	CONCENTRATION %	AT TEMP. + °C	POLYAMIDE			THERMOPLASTIC POLYURETHANE	POLYPROPYLENE
			PA6	PA66	PA12	PU	PP
Ethylene oxide, liquid	100	20					0
Ferric cyanide, hydrous	saturated	60					+
Ferrous chloride, hydrous, indiff.	10	20	+	+		+	+
Fluorine	50	40	pure -	pure -	pure -		-
Formaldehyde, hydrous	dilute	40	pure +	pure +	pure +		40% +
Formic acid, hydrous	10	20	0	0	+		+
Hydraulic fluid, hardly inflammable		80	+	+	+		
Hydraulic oil H and HL (DIN 51524)		100	+	+	+		
Hydrobromic acid, hydrous	to 10	40	-	-	-		+
Hydrochloric acid, hydrous	30	20	20% -	20% -	20% -	3% -	+
Hydrogen	100	60	20°C +	20°C +	20°C +		+
Hydrosilicofluoric acid, hydrous	to 30	20	-	-			+
Hydroxylamine sulphate, hydrous	to 12	30					+
Kerosine	100	80	+	+	+		20°C +
Lactic acid, hydrous	to 90	20	10% +	10% +	10% +	3% 0	+
Lubricating grease, base diester oil		110	0	0			
Lubricating grease, base silicone oil		110	+	+	+		
Magnesium chloride, hydrous	saturated	20	10% +	10% +	10% +		+
Mercury	pure	20	+	+	+		+
Methyl alcohol	100	20	+	+	+		40°C +
Methylene chloride	100	20	0	0	0		0
Mineral oil			+	+	+		20°C +
Nickel chloride, hydrous	saturated	20	10% 0	10% 0	10% 0		+
Nitric acid, hydrous	50	20	-	-	-	3% -	0
Oil and grease		20	+	+	+		0
Oleic acid	-	20	+	+	+		+
Oxalic acid	any	20	10% 0	10% 0	10% 0	3% 0	+
Phosphoric acid, hydrous	dilute	20	10% -	10% -	10% -	3% 0	+
Potassium bromide, hydrous	any	20	10% +	10% +	10% +		+
Potassium chloride, hydrous	10	20	+	+	+		+
Potassium dichromate, hydrous	40	20	5% 0	5% 0	5% 0		+
Potassium nitrate, hydrous	any	20	10% +	10% +	10% +		+
Sea water		40	+	+	+	20°C +	+
Soap solution, hydrous	any	20	dilute +	dilute +	dilute +		+
Sodium chlorate, hydrous	saturated	20	10% 0	10% 0	10% 0		+
Sulphuric acid, hydrous	10	20	-	-	-	3% -	50% +
Tin dichloride, hydrous	dilute	40					+
Toluene	100	20	+	+	+	-	
Trichloroethylene	100	20	0	0	0		0
Urea, hydrous	to 10	40	20% +	20% +	20% +		+
Vinyl acetate, Waste gas, containing carbon dioxide	100	20					+
Waste gas, containing SO2	any	60					
Xylene	100	20	+	+	+		-
Zinc chloride, hydrous	dilute	60	10% 0	10% 0			+
Zinc sulphate, hydrous	dilute	60					+

The resistance of polymeric materials to chemicals is dependent on species, induction period, temperature, quantity and concentration of the media. As we are not able to control the user's operating conditions, we cannot guarantee anything.

Source Plastic Table, B. Carlowitz, Carl Hanser Verlag, and others.

# Partnumber / page information

P/N	PAGE	P/N	PAGE	P/N	PAGE	P/N	PAGE	P/N	PAGE	P/N	PAGE	P/N	PAGE
043.231.0	1-43	256.507.0	1-4	261.116.0	2-8	264.118.0	2-10	266.432.0	9-23	267.336.0	9-18	268.225.1	9-14
055.581.0	1-43	256.509.0	1-4	261.117.0	2-8	264.120.0	2-10	266.440.0	9-23	267.348.0	9-18	268.232.0	9-14
055.973.0	1-44	256.511.0	1-4	261.118.0	2-8	264.125.0	2-10	266.450.0	9-23	267.407.0	9-18	268.232.1	9-14
055.983.0	1-44	256.516.0	1-4	261.120.0	2-8	264.132.0	2-10	266.463.0	9-23	267.410.0	9-18	268.240.0	9-14
057.261.0	1-43	256.521.0	1-4	261.125.0	2-8	264.140.0	2-10	266.512.0	9-23	267.412.0	9-18	268.240.1	9-14
059.401.0	1-43	256.529.0	1-4	261.132.0	2-8	264.150.0	2-10	266.516.0	9-23	267.417.0	9-18	268.250.0	9-14
107.010.2	1-11	256.536.0	1-4	261.140.0	2-8	265.116.0	9-17	266.520.0	9-23	267.423.0	9-18	268.250.1	9-14
107.012.2	1-11	256.548.0	1-4	261.150.0	2-8	265.116.1	9-17	266.525.0	9-23	267.429.0	9-18	268.263.0	9-14
107.016.2	1-11	256.610.0	1-6	261.160.0	2-8	265.120.0	9-17	266.532.0	9-23	267.436.0	9-18	268.316.0	9-14
107.020.2	1-11	256.612.0	1-6	261.207.0	2-9	265.120.1	9-17	266.540.0	9-23	267.448.0	9-18	268.316.1	9-14
107.026.2	1-11	256.616.0	1-6	261.209.0	2-9	265.125.0	9-17	266.550.0	9-23	267.500.0	9-19	268.320.0	9-14
107.035.2	1-11	256.620.0	1-6	261.211.0	2-9	265.125.1	9-17	266.612.0	9-25	267.501.0	9-19	268.320.1	9-14
107.710.2	1-27	256.625.0	1-6	261.213.0	2-9	265.132.0	9-17	266.616.0	9-25	267.507.0	9-18	268.325.0	9-14
107.712.2	1-27	256.632.0	1-6	261.216.0	2-9	265.140.0	9-17	266.620.0	9-25	267.510.0	9-18	268.325.1	9-14
107.716.2	1-27	256.640.0	1-6	261.221.0	2-9	265.150.0	9-17	266.625.0	9-25	267.512.0	9-18	268.332.0	9-14
107.720.2	1-27	256.650.0	1-6	261.229.0	2-9	265.163.0	9-17	266.632.0	9-25	267.517.0	9-18	268.332.1	9-14
107.726.2	1-27	260.110.0	2-8	261.236.0	2-9	265.316.0	9-17	266.640.0	9-25	267.523.0	9-18	268.340.0	9-14
107.735.2	1-27	260.111.0	2-8	261.248.0	2-9	265.316.1	9-17	266.650.0	9-25	267.529.0	9-18	268.340.1	9-14
107.740.2	1-27	260.112.0	2-8	261.507.0	1-43	265.320.0	9-17	266.663.0	9-25	267.536.0	9-18	268.350.0	9-14
107.750.2	1-27	260.115.0	2-8	261.616.0	2-21	265.320.1	9-17	266.707.0	9-25	267.548.0	9-18	268.350.1	9-14
222.703.1	1-44	260.116.0	2-8	261.617.0	2-21	265.325.0	9-17	266.709.0	9-25	267.610.0	9-20	268.363.0	9-14
256.010.0	1-4	260.117.0	2-8	261.620.0	2-21	265.325.1	9-17	266.711.0	9-25	267.613.0	9-20	268.407.0	9-15
256.011.0	1-4	260.118.0	2-8	261.625.0	2-21	265.332.0	9-17	266.713.0	9-25	267.617.0	9-20	268.407.1	9-15
256.012.0	1-4	260.120.0	2-8	261.632.0	2-21	265.340.0	9-17	266.716.0	9-25	267.622.0	9-20	268.409.0	9-15
256.015.0	1-4	260.125.0	2-8	261.711.0	2-22	265.350.1	9-17	266.721.0	9-25	267.710.0	9-20	268.409.1	9-15
256.016.0	1-4	260.132.0	2-8	261.716.0	2-22	265.363.0	9-17	266.729.0	9-25	267.711.0	9-20	268.411.0	9-15
256.017.0	1-4	260.140.0	2-8	261.721.0	2-22	265.509.0	9-17	266.736.0	9-25	267.713.0	9-20	268.411.1	9-15
256.020.0	1-4	260.150.0	2-8	261.729.0	2-22	265.511.0	9-17	266.748.0	9-25	267.714.0	9-20	268.413.0	9-15
256.025.0	1-4	260.160.0	2-8	262.210.0	2-10	265.513.1	9-17	266.812.0	6-18	267.717.0	9-20	268.413.1	9-15
256.032.0	1-4	260.207.0	2-9	262.212.0	2-10	265.516.0	9-17	266.817.0	6-18	267.817.0	9-20	268.416.0	9-15
256.040.0	1-4	260.209.0	2-9	262.216.0	2-10	265.521.0	9-17	266.823.0	6-18	267.820.0	9-20	268.421.0	9-15
256.050.0	1-4	260.211.0	2-9	262.218.0	2-10	265.529.0	9-17	266.829.0	6-18	267.821.0	9-20	268.429.0	9-15
256.060.0	1-4	260.213.0	2-9	262.220.0	2-10	265.536.0	9-17	266.836.0	6-18	267.822.0	9-20	268.436.0	9-15
256.110.0	1-4	260.216.0	2-9	262.225.0	2-10	265.548.0	9-17	267.016.0	9-14	268.012.0	9-13	268.448.0	9-15
256.111.0	1-4	260.221.0	2-9	262.232.0	2-10	265.709.0	9-17	267.016.1	9-14	268.012.1	9-13	268.507.0	9-15
256.112.0	1-4	260.229.0	2-9	262.240.0	2-10	265.711.0	9-17	267.020.0	9-14	268.016.0	9-13	268.507.1	9-15
256.115.0	1-4	260.236.0	2-9	262.250.0	2-10	265.713.0	9-17	267.020.1	9-14	268.016.1	9-13	268.509.0	9-15
256.116.0	1-4	260.248.0	2-9	263.016.0	8-9	265.716.0	9-17	267.020.2	9-14	268.020.0	9-13	268.509.1	9-15
256.117.0	1-4	260.311.0	2-9	263.020.0	8-9	265.721.0	9-17	267.025.0	9-14	268.020.1	9-13	268.511.0	9-15
256.120.0	1-4	260.312.0	2-9	263.025.0	8-9	265.729.0	9-17	267.025.1	9-14	268.025.0	9-13	268.511.1	9-15
256.125.0	1-4	260.315.0	2-9	263.032.0	8-9	265.736.0	9-17	267.032.0	9-14	268.025.1	9-13	268.513.0	9-15
256.132.0	1-4	260.316.0	2-9	263.116.0	8-9	265.748.0	9-17	267.109.0	9-15	268.032.0	9-13	268.513.1	9-15
256.140.0	1-4	260.317.0	2-9	263.120.0	8-9	266.109.0	9-24	267.111.0	9-15	268.040.0	9-13	268.516.0	9-15
256.150.0	1-4	260.320.0	2-9	263.125.0	8-9	266.111.0	9-24	267.113.0	9-15	268.050.0	9-13	268.521.0	9-15
256.160.0	1-4	260.325.0	2-9	263.132.0	8-9	266.115.0	9-24	267.113.1	9-15	268.063.0	9-13	268.529.0	9-15
256.312.0	1-4	260.332.0	2-9	263.312.0	8-10	266.116.0	9-24	267.116.0	9-15	268.112.0	9-13	268.536.0	9-15
256.315.0	1-4	260.340.0	2-9	263.316.0	8-10	266.121.0	9-24	267.121.0	9-15	268.112.1	9-13	268.548.0	9-15
256.316.0	1-4	260.350.0	2-9	263.320.0	8-10	266.129.0	9-24	267.129.0	9-15	268.116.0	9-13	268.609.0	9-16
256.317.0	1-4	260.507.0	1-43	263.326.0	8-10	266.136.0	9-24	267.207.0	9-18	268.116.1	9-13	268.611.0	9-16
256.320.0	1-4	260.616.0	2-21	263.335.0	8-10	266.142.0	9-24	267.210.0	9-18	268.120.0	9-13	268.613.0	9-16
256.325.0	1-4	260.617.0	2-21	263.340.0	8-10	266.148.0	9-24	267.212.0	9-18	268.120.1	9-13	268.616.0	9-16
256.332.0	1-4	260.620.0	2-21	263.350.0	8-10	266.207.0	9-24	267.217.0	9-18	268.125.0	9-13	268.621.0	9-16
256.340.0	1-4	260.625.0	2-21	263.412.0	8-10	266.209.0	9-24	267.223.0	9-18	268.125.1	9-13	268.629.0	9-16
256.350.0	1-4	260.632.0	2-21	263.416.0	8-10	266.211.0	9-24	267.229.0	9-18	268.132.0	9-13	268.636.0	9-16
256.407.0	1-4	260.711.0	2-22	263.420.0	8-10	266.216.0	9-24	267.236.0	9-18	268.140.0	9-13	268.648.0	9-16
256.409.0	1-4	260.716.0	2-22	263.426.0	8-10	266.221.0	9-24	267.248.0	9-18	268.150.0	9-13	268.709.0	9-16
256.411.0	1-4	260.721.0	2-22	263.435.0	8-10	266.229.0	9-24	267.307.0	9-18	268.163.0	9-13	268.711.0	9-16
256.416.0	1-4	260.729.0	2-22	263.440.0	8-10	266.236.0	9-24	267.310.0	9-18	268.216.0	9-14	268.713.0	9-16
256.421.0	1-4	261.110.0	2-8	263.450.0	8-10	266.242.0	9-24	267.312.0	9-18	268.216.1	9-14	268.716.0	9-16
256.429.0	1-4	261.111.0	2-8	264.110.0	2-10	266.416.0	9-23	267.317.0	9-18	268.220.0	9-14	268.721.0	9-16
256.436.0	1-4	261.112.0	2-8	264.112.0	2-10	266.420.0	9-23	267.323.0	9-18	268.220.1	9-14	268.729.0	9-16
256.448.0	1-4	261.115.0	2-8	264.116.0	2-10	266.425.0	9-23	267.329.0	9-18	268.225.0	9-14	268.736.0	9-16

PARTNUMBER / PAGE INFORMATION

P/N	PAGE	P/N	PAGE	P/N	PAGE	P/N	PAGE	P/N	PAGE	P/N	PAGE	P/N	PAGE
268.748.0	9 - 16	294.975.0	5 - 39	297.499.0	6 - 22	297.829.0	7 - 38	298.016.0	5 - 42	298.935.0	5 - 43	304.012.5	4 - 13
268.807.0	9 - 16	294.999.0	5 - 39	297.512.0	6 - 23	297.829.9	7 - 43	298.016.6	5 - 38	298.935.6	5 - 38	304.016.1	4 - 13
268.810.0	9 - 16	295.012.0	5 - 40	297.516.0	6 - 23	297.830.0	7 - 38	298.020.0	5 - 42	298.940.0	5 - 43	304.016.5	4 - 13
268.812.0	9 - 16	295.016.0	5 - 40	297.520.0	6 - 23	297.830.9	7 - 43	298.020.6	5 - 38	298.940.6	5 - 38	304.020.1	4 - 13
268.813.0	9 - 16	295.020.0	5 - 40	297.526.0	6 - 23	297.831.0	7 - 38	298.026.0	5 - 42	298.950.0	5 - 43	304.020.3	4 - 13
268.817.0	9 - 16	295.026.0	5 - 40	297.535.0	6 - 23	297.831.9	7 - 43	298.026.6	5 - 38	298.950.6	5 - 38	304.020.5	4 - 13
268.818.0	9 - 16	295.412.0	5 - 40	297.540.0	6 - 23	297.843.0	7 - 38	298.035.0	5 - 42	298.963.0	5 - 43	304.026.1	4 - 13
268.823.0	9 - 16	295.416.0	5 - 40	297.550.0	6 - 23	297.843.9	7 - 43	298.035.6	5 - 38	298.975.0	5 - 43	304.026.5	4 - 13
268.829.0	9 - 16	295.420.0	5 - 40	297.611.0	7 - 39	297.844.0	7 - 38	298.040.0	5 - 42	298.999.0	5 - 43	304.035.1	4 - 13
268.830.0	9 - 16	295.426.0	5 - 40	297.611.9	7 - 44	297.844.9	7 - 43	298.040.6	5 - 38	299.011.0	5 - 41	304.035.5	4 - 13
268.837.0	9 - 16	295.912.0	5 - 41	297.612.0	7 - 39	297.851.0	7 - 38	298.050.0	5 - 42	299.013.0	5 - 41	304.040.1	4 - 13
268.840.0	9 - 16	295.916.0	5 - 41	297.612.9	7 - 44	297.851.9	7 - 43	298.050.6	5 - 38	299.016.0	5 - 41	304.040.5	4 - 13
268.850.0	9 - 16	295.920.0	5 - 41	297.613.0	7 - 39	297.852.0	7 - 38	298.063.0	5 - 42	299.020.0	5 - 41	304.050.1	4 - 13
269.070.3	9 - 29	295.926.0	5 - 41	297.613.9	7 - 44	297.852.9	7 - 43	298.075.0	5 - 42	299.026.0	5 - 41	304.050.5	4 - 13
269.099.3	9 - 29	296.012.0	1 - 49	297.614.0	7 - 39	297.853.0	7 - 38	298.099.0	5 - 42	299.035.0	5 - 41	304.212.1	4 - 14
269.130.0	9 - 30	296.016.0	1 - 49	297.614.9	7 - 44	297.853.9	7 - 43	298.212.0	5 - 43	299.040.0	5 - 41	304.216.1	4 - 14
269.140.0	9 - 30	296.020.0	1 - 49	297.615.0	7 - 39	297.854.0	7 - 38	298.216.0	5 - 43	299.050.0	5 - 41	304.220.1	4 - 14
269.150.0	9 - 30	296.026.0	1 - 49	297.615.9	7 - 44	297.855.0	7 - 38	298.220.0	5 - 43	299.411.0	5 - 41	304.226.1	4 - 14
269.160.0	9 - 30	296.035.0	1 - 49	297.618.0	7 - 39	297.856.0	7 - 38	298.226.0	5 - 43	299.413.0	5 - 41	304.235.1	4 - 14
269.170.3	9 - 29	296.040.0	1 - 49	297.618.9	7 - 44	297.857.0	7 - 38	298.235.0	5 - 43	299.416.0	5 - 41	304.240.1	4 - 14
269.199.3	9 - 29	296.050.0	1 - 49	297.619.0	7 - 39	297.858.0	7 - 38	298.240.0	5 - 43	299.420.0	5 - 41	304.250.1	4 - 14
269.230.0	9 - 30	296.112.5	1 - 49	297.619.9	7 - 44	297.912.0	7 - 39	298.250.0	5 - 43	299.426.0	5 - 41	308.012.1	4 - 18
269.240.0	9 - 30	296.116.5	1 - 49	297.623.0	7 - 39	297.912.9	7 - 44	298.312.0	8 - 5	299.435.0	5 - 41	308.016.1	4 - 18
269.250.0	9 - 30	296.120.5	1 - 49	297.623.9	7 - 44	297.913.0	7 - 39	298.316.0	8 - 5	299.440.0	5 - 41	308.020.1	4 - 18
269.260.0	9 - 30	296.912.0	1 - 50	297.624.0	7 - 39	297.913.9	7 - 44	298.320.0	8 - 5	299.450.0	5 - 41	308.026.1	4 - 18
269.270.3	9 - 30	296.916.0	1 - 50	297.624.9	7 - 44	297.914.0	7 - 39	298.326.0	8 - 5	299.911.0	5 - 42	308.035.1	4 - 18
269.299.3	9 - 30	296.920.0	1 - 50	297.625.0	7 - 39	297.914.9	7 - 44	298.335.0	8 - 5	299.913.0	5 - 42	308.040.1	4 - 18
269.370.3	9 - 30	296.926.0	1 - 50	297.625.9	7 - 44	297.915.0	7 - 39	298.340.0	8 - 5	299.916.0	5 - 42	308.050.1	4 - 18
269.399.3	9 - 30	296.935.0	1 - 50	297.629.0	7 - 39	297.915.9	7 - 44	298.350.0	8 - 5	299.920.0	5 - 42	308.212.1	4 - 17
269.512.0	9 - 24	296.940.0	1 - 50	297.629.9	7 - 44	297.918.0	7 - 39	298.412.0	5 - 42	299.926.0	5 - 42	308.216.1	4 - 17
269.516.0	9 - 24	296.950.0	1 - 50	297.630.0	7 - 39	297.918.9	7 - 44	298.416.0	5 - 42	299.935.0	5 - 42	308.220.1	4 - 17
269.520.0	9 - 24	297.016.0	6 - 22	297.630.9	7 - 44	297.919.0	7 - 39	298.420.0	5 - 42	299.940.0	5 - 42	308.226.1	4 - 17
269.525.0	9 - 24	297.020.0	6 - 22	297.631.0	7 - 39	297.919.9	7 - 44	298.426.0	5 - 42	299.950.0	5 - 42	308.235.1	4 - 17
269.532.0	9 - 24	297.026.0	6 - 22	297.631.9	7 - 44	297.923.0	7 - 39	298.435.0	5 - 42	300.012.0	8 - 7	308.240.1	4 - 17
269.540.0	9 - 24	297.035.0	6 - 22	297.643.0	7 - 39	297.923.9	7 - 44	298.440.0	5 - 42	300.016.0	8 - 7	308.250.1	4 - 17
269.550.0	9 - 24	297.040.0	6 - 22	297.643.9	7 - 44	297.924.0	7 - 39	298.450.0	5 - 42	300.020.0	8 - 7	309.006.1	3 - 14
269.563.0	9 - 24	297.050.0	6 - 22	297.644.0	7 - 39	297.924.9	7 - 44	298.463.0	5 - 42	300.026.0	8 - 7	309.010.1	3 - 14
269.907.0	9 - 23	297.212.0	6 - 22	297.644.9	7 - 44	297.925.0	7 - 39	298.475.0	5 - 42	300.035.0	8 - 7	309.010.3	3 - 14
269.907.3	9 - 22	297.216.0	6 - 22	297.651.0	7 - 39	297.925.9	7 - 44	298.499.0	5 - 42	300.040.0	8 - 7	309.012.1	3 - 14
269.909.0	9 - 23	297.220.0	6 - 22	297.651.9	7 - 44	297.929.0	7 - 39	298.612.0	5 - 43	300.050.0	8 - 7	309.012.3	3 - 14
269.909.3	9 - 22	297.226.0	6 - 22	297.652.0	7 - 39	297.929.9	7 - 44	298.616.0	5 - 43	300.140.0	8 - 9	309.012.5	3 - 14
269.911.0	9 - 23	297.235.0	6 - 22	297.652.9	7 - 44	297.930.0	7 - 39	298.620.0	5 - 43	301.070.1	9 - 26	309.016.1	3 - 14
269.911.3	9 - 22	297.240.0	6 - 22	297.653.0	7 - 39	297.930.9	7 - 44	298.626.0	5 - 43	301.070.3	9 - 26	309.016.3	3 - 14
269.913.0	9 - 23	297.250.0	6 - 22	297.653.9	7 - 44	297.931.0	7 - 39	298.712.0	8 - 5	301.099.1	9 - 26	309.016.5	3 - 14
269.913.3	9 - 22	297.263.0	6 - 22	297.812.0	7 - 38	297.931.9	7 - 44	298.716.0	8 - 5	301.099.3	9 - 26	309.020.1	3 - 14
269.916.0	9 - 23	297.275.0	6 - 22	297.812.9	7 - 43	297.943.0	7 - 39	298.720.0	8 - 5	301.170.1	9 - 26	309.020.3	3 - 14
269.916.3	9 - 22	297.299.0	6 - 22	297.813.0	7 - 38	297.943.9	7 - 44	298.726.0	8 - 5	301.170.3	9 - 26	309.020.5	3 - 14
269.9210.0	9 - 23	297.312.0	6 - 23	297.813.9	7 - 43	297.944.0	7 - 39	298.735.0	8 - 5	301.199.1	9 - 26	309.026.1	3 - 14
269.921.3	9 - 22	297.316.0	6 - 23	297.814.0	7 - 38	297.944.9	7 - 44	298.740.0	8 - 5	301.199.3	9 - 26	309.026.3	3 - 14
269.929.0	9 - 23	297.320.0	6 - 23	297.814.9	7 - 43	297.951.0	7 - 39	298.750.0	8 - 5	301.270.1	9 - 27	309.026.5	3 - 14
269.929.3	9 - 22	297.326.0	6 - 23	297.815.0	7 - 38	297.951.9	7 - 44	298.812.0	5 - 44	301.270.3	9 - 27	309.035.1	3 - 14
269.936.0	9 - 23	297.335.0	6 - 23	297.815.9	7 - 43	297.952.0	7 - 39	298.816.0	5 - 44	301.299.1	9 - 27	309.035.5	3 - 14
269.936.3	9 - 22	297.340.0	6 - 23	297.818.0	7 - 38	297.952.9	7 - 44	298.820.0	5 - 44	301.299.3	9 - 27	309.040.1	3 - 14
269.948.0	9 - 23	297.350.0	6 - 23	297.818.9	7 - 43	297.953.0	7 - 39	298.826.0	5 - 44	301.370.1	9 - 27	309.040.5	3 - 14
269.948.3	9 - 22	297.416.0	6 - 22	297.819.0	7 - 38	297.953.9	7 - 44	298.912.0	5 - 43	301.370.3	9 - 27	309.050.1	3 - 14
293.040.0	5 - 39	297.420.0	6 - 22	297.819.9	7 - 43	297.954.0	7 - 39	298.912.6	5 - 38	301.399.1	9 - 27	309.050.5	3 - 14
293.050.0	5 - 39	297.426.0	6 - 22	297.823.0	7 - 38	297.955.0	7 - 39	298.916.0	5 - 43	301.399.3	9 - 27	310.012.1	3 - 4
294.063.0	5 - 39	297.435.0	6 - 22	297.823.9	7 - 43	297.956.0	7 - 39	298.916.6	5 - 38	301.470.1	9 - 28	310.012.5	3 - 4
294.075.0	5 - 39	297.440.0	6 - 22	297.824.0	7 - 38	297.957.0	7 - 39	298.920.0	5 - 43	301.499.1	9 - 28	310.016.1	3 - 4
294.099.0	5 - 39	297.450.0	6 - 22	297.824.9	7 - 43	297.958.0	7 - 39	298.920.6	5 - 38	301.570.1	9 - 28	310.016.5	3 - 4
294.125.0	5 - 39	297.463.0	6 - 22	297.825.0	7 - 38	298.012.0	5 - 42	298.926.0	5 - 43	301.599.1	9 - 28	310.020.1	3 - 4
294.963.0	5 - 39	297.475.0	6 - 22	297.825.9	7 - 43	298.012.6	5 - 38	298.926.6	5 - 38	304.012.1	4 - 13	310.020.5	3 - 4



PARTNUMBER / PAGE INFORMATION

P/N	PAGE	P/N	PAGE	P/N	PAGE	P/N	PAGE	P/N	PAGE	P/N	PAGE	P/N	PAGE
310.026.1	3 - 4	314.040.5	3 - 3	318.020.1	4 - 3	324.026.1	4 - 11	331.026.3	3 - 11	336.010.3	10 - 5	336.340.1	10 - 25
310.026.5	3 - 4	314.050.1	3 - 3	318.020.3	4 - 3	324.035.1	4 - 11	331.026.5	3 - 11	336.013.0	10 - 5	336.340.5	10 - 25
310.035.1	3 - 4	314.050.5	3 - 3	318.026.1	4 - 3	324.040.1	4 - 11	331.035.1	3 - 11	336.013.1	10 - 5	336.350.0	10 - 26
310.035.5	3 - 4	315.006.1	3 - 6	318.026.3	4 - 3	324.050.1	4 - 11	331.035.5	3 - 11	336.013.3	10 - 5	336.350.1	10 - 26
310.040.1	3 - 4	315.010.1	3 - 6	318.035.1	4 - 3	325.012.0	8 - 8	331.040.1	3 - 11	336.016.0	10 - 5	336.350.5	10 - 26
310.040.5	3 - 4	315.010.3	3 - 6	318.035.3	4 - 3	325.016.0	8 - 8	331.050.1	3 - 11	336.016.1	10 - 5	336.420.0	10 - 28
310.050.1	3 - 4	315.012.1	3 - 6	318.040.1	4 - 3	325.020.0	8 - 8	332.012.1	1 - 48	336.016.3	10 - 5	336.420.1	10 - 28
310.050.5	3 - 4	315.012.3	3 - 6	318.050.1	4 - 3	325.026.0	8 - 8	332.016.1	1 - 48	336.019.0	10 - 5	336.420.5	10 - 28
311.006.1	3 - 5	315.012.5	3 - 6	319.012.1	4 - 8	325.035.0	8 - 8	332.020.1	1 - 48	336.019.1	10 - 5	336.440.0	10 - 24
311.010.1	3 - 5	315.016.1	3 - 6	319.012.3	4 - 8	325.040.0	8 - 8	332.026.1	1 - 48	336.019.3	10 - 5	336.440.1	10 - 24
311.010.3	3 - 5	315.016.3	3 - 6	319.016.1	4 - 8	325.050.0	8 - 8	332.035.1	1 - 48	336.022.0	10 - 5	336.440.5	10 - 24
311.012.1	3 - 5	315.016.5	3 - 6	319.016.3	4 - 8	326.012.1	3 - 10	332.040.1	1 - 48	336.022.1	10 - 5	336.470.0	10 - 27
311.012.3	3 - 5	315.020.1	3 - 6	319.020.1	4 - 8	326.012.3	3 - 10	332.050.1	1 - 48	336.022.3	10 - 5	336.470.1	10 - 27
311.012.5	3 - 5	315.020.3	3 - 6	319.020.3	4 - 8	326.012.5	3 - 10	332.112.1	1 - 47	336.025.0	10 - 5	336.470.3	10 - 27
311.016.1	3 - 5	315.020.5	3 - 6	319.026.1	4 - 8	326.016.1	3 - 10	332.116.1	1 - 47	336.025.1	10 - 5	336.525.0	10 - 14
311.016.3	3 - 5	315.026.1	3 - 6	319.026.3	4 - 8	326.016.3	3 - 10	332.120.1	1 - 47	336.025.3	10 - 5	336.525.1	10 - 14
311.016.5	3 - 5	315.026.3	3 - 6	320.006.1	3 - 7	326.016.5	3 - 10	332.126.1	1 - 47	336.029.0	10 - 5	336.525.6	10 - 14
311.020.1	3 - 5	315.026.5	3 - 6	320.010.1	3 - 7	326.020.1	3 - 10	332.135.1	1 - 47	336.029.1	10 - 5	336.532.0	10 - 14
311.020.3	3 - 5	315.035.1	3 - 6	320.010.3	3 - 7	326.020.3	3 - 10	332.140.1	1 - 47	336.029.3	10 - 5	336.532.1	10 - 14
311.020.5	3 - 5	315.035.3	3 - 6	320.012.1	3 - 7	326.020.5	3 - 10	332.150.1	1 - 47	336.032.0	10 - 5	336.532.6	10 - 14
311.026.1	3 - 5	315.035.5	3 - 6	320.012.3	3 - 7	326.026.1	3 - 10	333.006.1	4 - 5	336.032.1	10 - 5	336.538.0	10 - 14
311.026.3	3 - 5	315.040.1	3 - 6	320.012.5	3 - 7	326.026.3	3 - 10	333.010.1	4 - 5	336.032.3	10 - 5	336.538.1	10 - 14
311.026.5	3 - 5	315.040.5	3 - 6	320.016.1	3 - 7	326.026.5	3 - 10	333.010.3	4 - 5	336.035.0	10 - 5	336.538.6	10 - 14
311.035.1	3 - 5	315.050.1	3 - 6	320.016.3	3 - 7	326.035.1	3 - 10	333.012.1	4 - 5	336.035.1	10 - 5	336.544.0	10 - 14
311.035.3	3 - 5	315.050.5	3 - 6	320.016.5	3 - 7	326.035.5	3 - 10	333.012.3	4 - 5	336.035.3	10 - 5	336.544.1	10 - 14
311.035.5	3 - 5	315.063.1	3 - 6	320.020.1	3 - 7	326.040.1	3 - 10	333.016.1	4 - 5	336.038.0	10 - 5	336.544.6	10 - 14
311.040.1	3 - 5	315.075.1	3 - 6	320.020.3	3 - 7	326.040.5	3 - 10	333.016.3	4 - 5	336.038.1	10 - 5	336.551.0	10 - 14
311.040.5	3 - 5	315.100.1	3 - 6	320.020.5	3 - 7	326.050.1	3 - 10	333.020.1	4 - 5	336.038.3	10 - 5	336.551.1	10 - 14
311.050.1	3 - 5	315.125.1	3 - 6	320.026.1	3 - 7	326.050.5	3 - 10	333.020.3	4 - 5	336.041.0	10 - 5	336.551.6	10 - 14
311.050.5	3 - 5	315.150.1	3 - 6	320.026.3	3 - 7	330.012.2	3 - 15	333.026.1	4 - 5	336.041.1	10 - 5	336.557.0	10 - 14
311.063.1	3 - 5	317.006.1	3 - 9	320.026.5	3 - 7	330.012.3	3 - 15	333.026.3	4 - 5	336.041.3	10 - 5	336.557.1	10 - 14
311.075.1	3 - 5	317.010.1	3 - 9	320.035.1	3 - 7	330.012.5	3 - 15	333.035.1	4 - 5	336.044.0	10 - 5	336.557.6	10 - 14
311.100.1	3 - 5	317.010.3	3 - 9	320.035.3	3 - 7	330.016.2	3 - 15	333.512.1	4 - 9	336.044.1	10 - 5	336.564.0	10 - 14
311.125.1	3 - 5	317.012.1	3 - 9	320.035.5	3 - 7	330.016.3	3 - 15	333.516.1	4 - 9	336.044.3	10 - 5	336.564.1	10 - 14
311.150.1	3 - 5	317.012.3	3 - 9	320.040.1	3 - 7	330.016.5	3 - 15	333.520.1	4 - 9	336.051.0	10 - 5	336.564.6	10 - 14
312.512.1	3 - 16	317.012.5	3 - 9	320.040.5	3 - 7	330.020.2	3 - 15	333.526.1	4 - 9	336.051.1	10 - 5	336.570.0	10 - 14
312.516.1	3 - 16	317.016.1	3 - 9	320.050.1	3 - 7	330.020.3	3 - 15	334.012.1	3 - 17	336.051.3	10 - 5	336.570.1	10 - 14
312.520.1	3 - 16	317.016.3	3 - 9	320.050.5	3 - 7	330.020.5	3 - 15	334.012.5	3 - 17	336.057.0	10 - 5	336.570.6	10 - 14
312.526.1	3 - 16	317.016.5	3 - 9	320.063.1	3 - 7	330.026.1	3 - 15	334.016.1	3 - 17	336.057.1	10 - 5	336.576.0	10 - 14
312.535.1	3 - 16	317.020.1	3 - 9	320.075.1	3 - 7	330.026.3	3 - 15	334.016.5	3 - 17	336.057.3	10 - 5	336.576.1	10 - 14
312.540.1	3 - 16	317.020.3	3 - 9	320.100.1	3 - 7	330.026.5	3 - 15	334.020.1	3 - 17	336.064.0	10 - 5	336.576.6	10 - 14
312.550.1	3 - 16	317.020.5	3 - 9	321.012.1	8 - 3	330.035.1	3 - 15	334.020.5	3 - 17	336.064.1	10 - 5	336.583.0	10 - 14
312.563.1	3 - 16	317.026.1	3 - 9	321.016.1	8 - 3	330.035.5	3 - 15	334.026.1	3 - 17	336.064.3	10 - 5	336.583.1	10 - 14
312.575.1	3 - 16	317.026.3	3 - 9	321.020.1	8 - 3	330.040.1	3 - 15	334.026.5	3 - 17	336.070.0	10 - 5	336.583.6	10 - 14
313.012.1	8 - 4	317.026.5	3 - 9	321.026.1	8 - 3	330.040.5	3 - 15	334.035.1	3 - 17	336.070.1	10 - 5	336.589.0	10 - 14
313.016.1	8 - 4	317.035.1	3 - 9	321.035.1	8 - 3	330.050.1	3 - 15	334.035.5	3 - 17	336.070.3	10 - 5	336.589.1	10 - 14
313.020.1	8 - 4	317.035.3	3 - 9	321.040.1	8 - 3	330.050.5	3 - 15	334.040.1	3 - 17	336.076.0	10 - 5	336.589.6	10 - 14
313.026.1	8 - 4	317.035.5	3 - 9	321.050.1	8 - 3	330.063.1	3 - 15	334.040.5	3 - 17	336.076.1	10 - 5	336.595.0	10 - 14
313.035.1	8 - 4	317.040.1	3 - 9	322.012.1	3 - 8	330.075.1	3 - 15	334.050.1	3 - 17	336.076.3	10 - 5	336.595.1	10 - 14
313.040.1	8 - 4	317.040.5	3 - 9	322.016.1	3 - 8	331.006.1	3 - 11	334.050.5	3 - 17	336.083.0	10 - 5	336.595.6	10 - 14
313.050.1	8 - 4	317.050.1	3 - 9	322.020.1	3 - 8	331.010.1	3 - 11	335.212.1	3 - 12	336.083.1	10 - 5	336.604.1	10 - 18
314.012.1	3 - 3	317.050.5	3 - 9	322.026.1	3 - 8	331.010.3	3 - 11	335.216.1	3 - 12	336.083.3	10 - 5	336.604.3	10 - 18
314.012.5	3 - 3	317.063.1	3 - 9	322.035.1	3 - 8	331.012.1	3 - 11	335.220.1	3 - 12	336.089.0	10 - 5	336.604.8	10 - 18
314.016.1	3 - 3	317.075.1	3 - 9	323.016.1	3 - 18	331.012.3	3 - 11	335.226.1	3 - 12	336.089.1	10 - 5	336.606.1	10 - 18
314.016.5	3 - 3	317.100.1	3 - 9	323.020.1	3 - 18	331.012.5	3 - 11	335.235.1	3 - 12	336.089.3	10 - 5	336.606.3	10 - 18
314.020.1	3 - 3	318.006.1	4 - 3	323.026.1	3 - 18	331.016.1	3 - 11	335.240.1	3 - 12	336.095.0	10 - 5	336.606.8	10 - 18
314.020.5	3 - 3	318.010.1	4 - 3	323.035.1	3 - 18	331.016.3	3 - 11	335.250.1	3 - 12	336.095.1	10 - 5	336.610.1	10 - 18
314.026.1	3 - 3	318.010.3	4 - 3	323.040.1	3 - 18	331.016.5	3 - 11	336.006.0	10 - 5	336.095.3	10 - 5	336.610.3	10 - 18
314.026.5	3 - 3	318.012.1	4 - 3	323.050.1	3 - 18	331.020.1	3 - 11	336.006.1	10 - 5	336.102.0	10 - 5	336.610.8	10 - 18
314.035.1	3 - 3	318.012.3	4 - 3	324.012.1	4 - 11	331.020.3	3 - 11	336.006.3	10 - 5	336.102.1	10 - 5	336.614.1	10 - 18
314.035.5	3 - 3	318.016.1	4 - 3	324.016.1	4 - 11	331.020.5	3 - 11	336.010.0	10 - 5	336.102.3	10 - 5	336.614.3	10 - 18
314.040.1	3 - 3	318.016.3	4 - 3	324.020.1	4 - 11	331.026.1	3 - 11	336.010.1	10 - 5	336.340.0	10 - 25	336.614.8	10 - 18

PARTNUMBER / PAGE INFORMATION

P/N	PAGE	P/N	PAGE	P/N	PAGE	P/N	PAGE	P/N	PAGE	P/N	PAGE	P/N	PAGE
336.622.1	10 - 18	336.990.1	10 - 15	339.250.1	4 - 6	347.430.0	10 - 29	355.016.5	10 - 10	361.050.2	2 - 4	375.025.2	2 - 20
336.622.3	10 - 18	336.990.6	10 - 15	339.412.1	4 - 10	347.430.5	10 - 29	355.020.5	10 - 10	370.010.5	1 - 3	375.032.2	2 - 20
336.622.8	10 - 18	336.991.0	10 - 15	339.416.1	4 - 10	347.625.3	10 - 23	356.732.3	10 - 16	370.012.2	1 - 3	465.012.1	1 - 51
336.644.1	10 - 18	336.991.1	10 - 15	339.420.1	4 - 10	347.625.6	10 - 23	356.738.3	10 - 16	370.012.5	1 - 3	465.012.3	1 - 51
336.644.3	10 - 18	336.991.6	10 - 15	339.426.1	4 - 10	347.638.3	10 - 23	356.751.3	10 - 16	370.016.1	1 - 3	465.012.5	1 - 51
336.806.3	10 - 6	336.992.0	10 - 15	340.012.1	4 - 7	347.638.6	10 - 23	356.776.3	10 - 16	370.016.2	1 - 3	465.016.1	1 - 51
336.810.3	10 - 6	336.992.1	10 - 15	340.012.3	4 - 7	347.651.3	10 - 23	356.799.3	10 - 16	370.016.5	1 - 3	465.016.3	1 - 51
336.813.3	10 - 6	336.992.6	10 - 15	340.016.1	4 - 7	347.651.6	10 - 23	357.102.8	10 - 21	370.020.1	1 - 3	465.016.5	1 - 51
336.816.3	10 - 6	336.994.0	10 - 15	340.016.3	4 - 7	347.664.3	10 - 23	357.104.8	10 - 21	370.020.2	1 - 3	465.020.1	1 - 51
336.819.3	10 - 6	336.994.1	10 - 15	340.020.1	4 - 7	347.664.6	10 - 23	357.105.8	10 - 21	370.020.5	1 - 3	465.020.3	1 - 51
336.822.3	10 - 6	336.994.6	10 - 15	340.020.3	4 - 7	347.664.8	10 - 23	357.106.8	10 - 21	370.025.1	1 - 3	465.020.5	1 - 51
336.825.3	10 - 6	336.996.0	10 - 15	340.026.1	4 - 7	347.676.3	10 - 23	357.108.8	10 - 21	370.025.2	1 - 3	465.025.1	1 - 51
336.829.3	10 - 6	336.996.1	10 - 15	340.026.3	4 - 7	347.676.6	10 - 23	357.110.8	10 - 21	370.025.5	1 - 3	465.025.3	1 - 51
336.832.3	10 - 6	336.996.6	10 - 15	340.035.1	4 - 7	347.676.8	10 - 23	357.112.8	10 - 21	370.032.1	1 - 3	511.010.0	1 - 42
336.835.3	10 - 6	336.998.0	10 - 15	341.012.1	4 - 15	347.689.3	10 - 23	357.116.8	10 - 21	370.032.2	1 - 3	512.010.0	1 - 30
336.838.3	10 - 6	336.998.1	10 - 15	341.016.1	4 - 15	347.689.6	10 - 23	357.118.8	10 - 21	370.040.1	1 - 3	512.012.0	1 - 30
336.841.3	10 - 6	336.998.6	10 - 15	341.020.1	4 - 15	347.689.8	10 - 23	357.122.8	10 - 21	370.040.2	1 - 3	512.016.0	1 - 30
336.844.3	10 - 6	336.999.0	10 - 15	341.026.1	4 - 15	347.695.3	10 - 23	358.012.1	4 - 4	370.050.1	1 - 3	512.022.0	1 - 30
336.851.3	10 - 6	336.999.1	10 - 15	346.013.3	10 - 7	347.695.6	10 - 23	358.016.1	4 - 4	370.050.2	1 - 3	512.025.0	1 - 30
336.857.3	10 - 6	336.999.6	10 - 15	346.016.3	10 - 7	347.695.8	10 - 23	358.020.1	4 - 4	371.010.2	2 - 5	512.034.0	1 - 30
336.864.3	10 - 6	337.025.1	10 - 12	346.019.3	10 - 7	347.698.3	10 - 23	358.026.1	4 - 4	371.010.5	2 - 5	512.040.0	1 - 30
336.870.3	10 - 6	337.025.3	10 - 12	346.029.3	10 - 7	347.698.6	10 - 23	358.035.1	4 - 4	371.012.2	2 - 5	512.050.0	1 - 30
336.876.3	10 - 6	337.050.1	10 - 12	346.035.3	10 - 7	347.698.8	10 - 23	359.012.0	8 - 13	371.012.5	2 - 5	515.010.0	1 - 28
336.883.3	10 - 6	337.050.3	10 - 12	346.041.3	10 - 7	348.010.1	3 - 13	359.016.0	8 - 13	371.016.1	2 - 5	515.012.0	1 - 28
336.889.3	10 - 6	337.076.1	10 - 12	346.051.3	10 - 7	348.012.1	3 - 13	359.020.0	8 - 13	371.016.2	2 - 5	515.016.0	1 - 28
336.895.3	10 - 6	337.076.3	10 - 12	346.113.3	10 - 7	348.016.1	3 - 13	359.026.0	8 - 13	371.016.5	2 - 5	515.022.0	1 - 28
336.897.3	10 - 6	337.100.1	10 - 12	346.116.3	10 - 7	348.020.1	3 - 13	359.035.0	8 - 13	371.020.1	2 - 5	515.025.0	1 - 28
336.898.1	10 - 6	337.100.3	10 - 12	346.119.3	10 - 7	348.026.1	3 - 13	359.040.0	8 - 13	371.020.2	2 - 5	515.034.0	1 - 28
336.898.3	10 - 6	337.127.1	10 - 12	346.129.3	10 - 7	348.035.1	3 - 13	359.050.0	8 - 13	371.020.5	2 - 5	515.040.0	1 - 28
336.899.1	10 - 6	337.127.3	10 - 12	346.135.3	10 - 7	348.040.1	3 - 13	360.010.5	2 - 3	371.025.1	2 - 5	515.050.0	1 - 28
336.899.3	10 - 6	337.425.1	10 - 11	346.141.3	10 - 7	348.050.1	3 - 13	360.012.1	2 - 3	371.025.2	2 - 5	515.063.0	1 - 28
336.940.0	10 - 15	337.438.1	10 - 11	346.151.3	10 - 7	350.010.1	4 - 12	360.012.5	2 - 3	371.025.5	2 - 5	515.075.0	1 - 28
336.940.1	10 - 15	337.525.1	10 - 11	346.213.3	10 - 7	350.012.1	4 - 12	360.016.1	2 - 3	371.032.1	2 - 5	515.099.0	1 - 28
336.940.6	10 - 15	337.538.1	10 - 11	346.216.3	10 - 7	350.016.1	4 - 12	360.016.5	2 - 3	371.032.2	2 - 5	575.030.0	1 - 42
336.945.0	10 - 15	337.625.1	10 - 13	346.219.3	10 - 7	350.020.1	4 - 12	360.018.1	2 - 3	371.040.1	2 - 5	575.040.0	1 - 42
336.945.1	10 - 15	337.625.3	10 - 13	346.229.3	10 - 7	350.026.1	4 - 12	360.018.5	2 - 3	371.040.2	2 - 5	575.045.0	1 - 42
336.945.6	10 - 15	337.650.1	10 - 13	346.235.3	10 - 7	350.035.1	4 - 12	360.020.1	2 - 3	371.050.1	2 - 5	575.060.0	1 - 42
336.950.0	10 - 15	337.650.3	10 - 13	346.241.3	10 - 7	350.040.1	4 - 12	360.020.5	2 - 3	371.050.2	2 - 5	575.145.0	1 - 42
336.950.1	10 - 15	337.676.1	10 - 13	346.251.3	10 - 7	350.050.1	4 - 12	360.025.1	2 - 3	373.012.2	2 - 6	575.840.0	1 - 42
336.950.6	10 - 15	337.676.3	10 - 13	346.313.3	10 - 7	351.512.1	4 - 19	360.025.5	2 - 3	373.016.2	2 - 6	600.003.2	1 - 22
336.955.0	10 - 15	337.699.1	10 - 13	346.316.3	10 - 7	351.516.1	4 - 19	360.032.1	2 - 3	373.016.5	2 - 6	600.004.2	1 - 22
336.955.1	10 - 15	337.699.3	10 - 13	346.319.3	10 - 7	351.520.1	4 - 19	360.032.2	2 - 3	373.020.1	2 - 6	600.005.2	1 - 22
336.955.6	10 - 15	337.725.0	10 - 17	346.329.3	10 - 7	351.526.1	4 - 19	360.040.1	2 - 3	373.020.2	2 - 6	600.006.2	1 - 22
336.960.0	10 - 15	337.725.3	10 - 17	346.335.3	10 - 7	351.535.1	4 - 19	360.040.2	2 - 3	373.020.5	2 - 6	600.007.2	1 - 22
336.960.1	10 - 15	337.738.0	10 - 17	346.338.3	10 - 7	351.540.1	4 - 19	360.050.1	2 - 3	373.025.1	2 - 6	600.008.2	1 - 22
336.960.6	10 - 15	337.738.3	10 - 17	346.341.3	10 - 7	351.550.1	4 - 19	360.050.2	2 - 3	373.025.2	2 - 6	600.009.2	1 - 22
336.965.0	10 - 15	337.751.0	10 - 17	346.351.3	10 - 7	352.010.1	4 - 16	361.010.5	2 - 4	373.025.5	2 - 6	600.010.2	1 - 12
336.965.1	10 - 15	337.751.3	10 - 17	346.913.3	10 - 5	352.012.1	4 - 16	361.012.1	2 - 4	373.032.1	2 - 6	600.012.2	1 - 12
336.965.6	10 - 15	337.764.0	10 - 17	346.916.3	10 - 5	352.016.1	4 - 16	361.012.5	2 - 4	373.032.2	2 - 6	600.016.2	1 - 12
336.970.0	10 - 15	337.764.3	10 - 17	346.919.3	10 - 5	352.020.1	4 - 16	361.016.1	2 - 4	373.040.1	2 - 6	600.020.2	1 - 12
336.970.1	10 - 15	337.776.0	10 - 17	346.929.3	10 - 5	352.026.1	4 - 16	361.016.5	2 - 4	373.040.2	2 - 6	600.026.2	1 - 12
336.970.6	10 - 15	337.776.3	10 - 17	346.935.3	10 - 5	352.035.1	4 - 16	361.018.1	2 - 4	373.050.1	2 - 6	600.035.2	1 - 12
336.975.0	10 - 15	337.789.0	10 - 17	346.938.3	10 - 5	352.040.1	4 - 16	361.018.5	2 - 4	373.050.2	2 - 6	600.610.2	1 - 19
336.975.1	10 - 15	337.789.3	10 - 17	346.941.3	10 - 5	352.050.1	4 - 16	361.020.1	2 - 4	374.012.2	2 - 7	600.612.2	1 - 19
336.975.6	10 - 15	337.799.0	10 - 17	346.951.1	10 - 5	353.016.1	4 - 20	361.020.5	2 - 4	374.016.2	2 - 7	600.616.2	1 - 19
336.980.0	10 - 15	337.799.1	10 - 17	347.016.1	10 - 22	353.020.1	4 - 20	361.025.1	2 - 4	374.020.2	2 - 7	600.620.2	1 - 19
336.980.1	10 - 15	339.212.1	4 - 6	347.024.1	10 - 22	353.026.1	4 - 20	361.025.5	2 - 4	374.025.2	2 - 7	600.626.2	1 - 19
336.980.6	10 - 15	339.216.1	4 - 6	347.032.1	10 - 22	355.004.5	10 - 10	361.032.1	2 - 4	374.032.2	2 - 7	600.635.2	1 - 19
336.985.0	10 - 15	339.220.1	4 - 6	347.048.1	10 - 22	355.006.5	10 - 10	361.032.2	2 - 4	374.040.1	2 - 7	620.309.0	8 - 20
336.985.1	10 - 15	339.226.1	4 - 6	347.064.1	10 - 22	355.008.5	10 - 10	361.040.1	2 - 4	374.050.1	2 - 7	620.309.1	8 - 20
336.985.6	10 - 15	339.235.1	4 - 6	347.420.0	10 - 29	355.010.5	10 - 10	361.040.2	2 - 4	375.016.2	2 - 20	620.311.0	8 - 20
336.990.0	10 - 15	339.240.1	4 - 6	347.420.5	10 - 29	355.012.5	10 - 10	361.050.1	2 - 4	375.020.2	2 - 20	620.311.1	8 - 20

PARTNUMBER / PAGE INFORMATION

P/N	PAGE	P/N	PAGE	P/N	PAGE	P/N	PAGE	P/N	PAGE	P/N	PAGE	P/N	PAGE
620.313.0	8 - 20	650.836.4	8 - 24	710.021.4	2 - 13	710.942.7	1 - 34	712.040.8	1 - 40	712.716.4	2 - 12	712.914.0	5 - 4
620.313.1	8 - 20	650.842.4	8 - 24	710.021.5	2 - 18	710.948.1	5 - 5	712.040.9	5 - 20	712.716.5	2 - 17	712.914.3	1 - 8
620.316.0	8 - 20	650.848.4	8 - 24	710.021.6	1 - 15	710.948.7	1 - 34	712.045.4	2 - 11	712.716.6	1 - 14	712.914.4	2 - 12
620.316.1	8 - 20	651.316.2	8 - 22	710.021.7	1 - 33	710.950.4	2 - 13	712.050.1	5 - 3	712.716.7	1 - 32	712.914.6	1 - 14
620.321.0	8 - 20	651.320.2	8 - 22	710.029.1	5 - 5	712.014.0	5 - 3	712.050.7	1 - 32	712.716.9	5 - 29	712.914.7	1 - 33
620.321.1	8 - 20	651.325.2	8 - 22	710.029.3	1 - 9	712.014.3	1 - 7	712.050.8	1 - 40	712.717.1	5 - 4	712.914.9	5 - 20
620.329.0	8 - 20	651.332.2	8 - 22	710.029.4	2 - 13	712.014.4	2 - 11	712.050.9	5 - 20	712.717.3	1 - 8	712.915.0	5 - 4
620.329.1	8 - 20	651.340.2	8 - 22	710.029.5	2 - 18	712.014.6	1 - 13	712.055.4	2 - 11	712.717.4	2 - 12	712.915.3	1 - 8
620.336.0	8 - 20	651.350.2	8 - 22	710.029.6	1 - 15	712.014.7	1 - 32	712.060.4	2 - 11	712.717.5	2 - 17	712.915.4	2 - 12
620.336.1	8 - 20	651.363.2	8 - 22	710.029.7	1 - 33	712.014.8	1 - 40	712.063.1	5 - 3	712.717.6	1 - 14	712.915.6	1 - 14
620.342.0	8 - 20	651.716.2	8 - 23	710.036.1	5 - 5	712.014.9	5 - 20	712.063.7	1 - 32	712.717.7	1 - 32	712.915.7	1 - 33
620.342.1	8 - 20	651.717.2	8 - 23	710.036.6	1 - 15	712.015.0	5 - 3	712.063.8	1 - 40	712.717.9	5 - 29	712.915.9	5 - 20
620.348.0	8 - 20	651.720.2	8 - 23	710.036.7	1 - 33	712.015.3	1 - 7	712.063.9	5 - 20	712.720.1	5 - 4	712.916.1	5 - 4
620.348.1	8 - 20	651.725.2	8 - 23	710.040.4	2 - 13	712.015.4	2 - 11	712.075.1	5 - 3	712.720.3	1 - 8	712.916.3	1 - 8
620.409.0	8 - 21	651.732.2	8 - 23	710.042.1	5 - 5	712.015.6	1 - 13	712.075.7	1 - 32	712.720.4	2 - 12	712.916.4	2 - 12
620.409.1	8 - 21	651.740.2	8 - 23	710.042.7	1 - 33	712.015.7	1 - 32	712.090.1	5 - 3	712.720.5	2 - 17	712.916.5	2 - 17
620.411.0	8 - 21	651.750.2	8 - 23	710.048.1	5 - 5	712.015.8	1 - 40	712.090.7	1 - 32	712.720.6	1 - 14	712.916.6	1 - 14
620.411.1	8 - 21	651.763.2	8 - 23	710.048.7	1 - 33	712.015.9	5 - 20	712.114.9	5 - 28	712.720.7	1 - 32	712.916.7	1 - 33
620.413.0	8 - 21	651.812.4	8 - 24	710.050.4	2 - 13	712.016.1	5 - 3	712.115.9	5 - 28	712.720.9	5 - 29	712.916.8	1 - 41
620.413.1	8 - 21	651.816.4	8 - 24	710.911.1	5 - 5	712.016.3	1 - 7	712.116.9	5 - 28	712.722.1	5 - 4	712.916.9	5 - 20
620.416.0	8 - 21	651.817.4	8 - 24	710.911.3	1 - 9	712.016.4	2 - 11	712.117.9	5 - 28	712.722.3	1 - 8	712.917.1	5 - 4
620.416.1	8 - 21	651.820.4	8 - 24	710.911.4	2 - 13	712.016.5	2 - 16	712.120.9	5 - 28	712.722.4	2 - 12	712.917.3	1 - 8
620.421.0	8 - 21	651.825.4	8 - 24	710.911.5	2 - 19	712.016.6	1 - 13	712.125.9	5 - 28	712.722.5	2 - 17	712.917.4	2 - 12
620.421.1	8 - 21	651.832.4	8 - 24	710.911.6	1 - 15	712.016.7	1 - 32	712.132.9	5 - 28	712.722.6	1 - 14	712.917.5	2 - 17
620.429.0	8 - 21	651.840.4	8 - 24	710.911.7	1 - 34	712.016.8	1 - 40	712.140.9	5 - 28	712.722.7	1 - 32	712.917.6	1 - 14
620.429.1	8 - 21	651.850.4	8 - 24	710.912.0	5 - 5	712.016.9	5 - 20	712.150.9	5 - 28	712.722.9	5 - 29	712.917.7	1 - 33
620.436.0	8 - 21	651.863.4	8 - 24	710.912.3	1 - 9	712.017.1	5 - 3	712.163.9	5 - 28	712.725.1	5 - 4	712.917.8	1 - 41
620.436.1	8 - 21	705.015.0	6 - 25	710.912.6	1 - 15	712.017.3	1 - 7	712.414.0	5 - 4	712.725.3	1 - 8	712.917.9	5 - 20
620.442.0	8 - 21	705.016.1	6 - 25	710.912.7	1 - 34	712.017.4	2 - 11	712.415.0	5 - 4	712.725.4	2 - 12	712.920.1	5 - 4
620.442.1	8 - 21	705.018.1	6 - 25	710.913.1	5 - 5	712.017.5	2 - 16	712.416.1	5 - 4	712.725.5	2 - 17	712.920.3	1 - 8
620.448.0	8 - 21	705.020.1	6 - 25	710.913.3	1 - 9	712.017.6	1 - 13	712.417.1	5 - 4	712.725.6	1 - 14	712.920.4	2 - 12
620.448.1	8 - 21	705.023.1	6 - 25	710.913.4	2 - 13	712.017.7	1 - 32	712.420.1	5 - 4	712.725.7	1 - 32	712.920.5	2 - 17
650.509.2	8 - 22	705.028.1	6 - 25	710.913.5	2 - 19	712.017.8	1 - 40	712.425.1	5 - 4	712.725.9	5 - 29	712.920.6	1 - 14
650.511.2	8 - 22	705.035.1	6 - 25	710.913.6	1 - 15	712.017.9	5 - 20	712.432.1	5 - 4	712.728.1	5 - 4	712.920.7	1 - 33
650.513.2	8 - 22	710.011.1	5 - 5	710.913.7	1 - 34	712.020.1	5 - 3	712.440.1	5 - 4	712.728.3	1 - 8	712.920.8	1 - 41
650.516.2	8 - 22	710.011.3	1 - 9	710.914.0	5 - 5	712.020.3	1 - 7	712.450.1	5 - 4	712.728.4	2 - 12	712.920.9	5 - 20
650.521.2	8 - 22	710.011.4	2 - 13	710.914.3	1 - 9	712.020.4	2 - 11	712.463.1	5 - 4	712.728.5	2 - 17	712.925.1	5 - 4
650.529.2	8 - 22	710.011.5	2 - 18	710.914.6	1 - 15	712.020.5	2 - 16	712.475.1	5 - 4	712.728.6	1 - 14	712.925.3	1 - 8
650.536.2	8 - 22	710.011.6	1 - 15	710.914.7	1 - 34	712.020.6	1 - 13	712.514.9	5 - 28	712.728.7	1 - 32	712.925.4	2 - 12
650.542.2	8 - 22	710.011.7	1 - 33	710.916.1	5 - 5	712.020.7	1 - 32	712.515.9	5 - 28	712.728.9	5 - 29	712.925.5	2 - 17
650.548.2	8 - 22	710.012.0	5 - 5	710.916.3	1 - 9	712.020.8	1 - 40	712.516.9	5 - 28	712.732.1	5 - 4	712.925.6	1 - 14
650.609.3	8 - 22	710.012.3	1 - 9	710.916.4	2 - 13	712.020.9	5 - 20	712.517.9	5 - 28	712.732.3	1 - 8	712.925.7	1 - 33
650.611.3	8 - 22	710.012.6	1 - 15	710.916.5	2 - 19	712.025.1	5 - 3	712.520.9	5 - 28	712.732.4	2 - 12	712.925.8	1 - 41
650.613.3	8 - 22	710.012.7	1 - 33	710.916.6	1 - 15	712.025.3	1 - 7	712.525.9	5 - 28	712.732.5	2 - 17	712.925.9	5 - 20
650.616.3	8 - 22	710.013.1	5 - 5	710.916.7	1 - 34	712.025.4	2 - 11	712.532.9	5 - 28	712.732.6	1 - 14	712.932.1	5 - 4
650.621.3	8 - 22	710.013.3	1 - 9	710.921.1	5 - 5	712.025.5	2 - 16	712.540.9	5 - 28	712.732.7	1 - 32	712.932.3	1 - 8
650.629.3	8 - 22	710.013.4	2 - 13	710.921.3	1 - 9	712.025.6	1 - 13	712.550.9	5 - 28	712.732.9	5 - 29	712.932.4	2 - 12
650.709.2	8 - 23	710.013.5	2 - 18	710.921.4	2 - 13	712.025.7	1 - 32	712.563.9	5 - 28	712.735.1	5 - 4	712.932.5	2 - 17
650.711.2	8 - 23	710.013.6	1 - 15	710.921.5	2 - 19	712.025.8	1 - 40	712.712.2	5 - 4	712.735.3	1 - 8	712.932.6	1 - 14
650.713.2	8 - 23	710.013.7	1 - 33	710.921.6	1 - 15	712.025.9	5 - 20	712.713.2	5 - 4	712.735.4	2 - 12	712.932.7	1 - 33
650.716.2	8 - 23	710.014.0	5 - 5	710.921.7	1 - 34	712.032.1	5 - 3	712.714.2	5 - 4	712.735.5	2 - 17	712.932.8	1 - 41
650.721.2	8 - 23	710.014.3	1 - 9	710.929.1	5 - 5	712.032.3	1 - 7	712.714.3	1 - 8	712.735.6	1 - 14	712.932.9	5 - 20
650.729.2	8 - 23	710.014.6	1 - 15	710.929.3	1 - 9	712.032.4	2 - 11	712.714.4	2 - 12	712.735.7	1 - 32	712.940.1	5 - 4
650.736.2	8 - 23	710.014.7	1 - 33	710.929.4	2 - 13	712.032.5	2 - 16	712.714.6	1 - 14	712.735.9	5 - 29	712.940.6	1 - 14
650.742.2	8 - 23	710.016.1	5 - 5	710.929.5	2 - 19	712.032.6	1 - 13	712.714.7	1 - 32	712.740.1	5 - 4	712.940.7	1 - 33
650.748.2	8 - 23	710.016.3	1 - 9	710.929.6	1 - 15	712.032.7	1 - 32	712.715.2	5 - 4	712.740.6	1 - 14	712.940.8	1 - 41
650.809.4	8 - 24	710.016.4	2 - 13	710.929.7	1 - 34	712.032.8	1 - 40	712.715.3	1 - 8	712.740.7	1 - 32	712.940.9	5 - 20
650.811.4	8 - 24	710.016.5	2 - 18	710.936.1	5 - 5	712.032.9	5 - 20	712.715.4	2 - 12	712.740.9	5 - 29	712.945.4	2 - 12
650.813.4	8 - 24	710.016.6	1 - 15	710.936.6	1 - 15	712.040.1	5 - 3	712.715.6	1 - 14	712.745.1	5 - 4	712.950.1	5 - 4
650.816.4	8 - 24	710.016.7	1 - 33	710.936.7	1 - 34	712.040.4	2 - 11	712.715.7	1 - 32	712.745.9	5 - 29	712.950.7	1 - 33
650.821.4	8 - 24	710.021.1	5 - 5	710.940.4	2 - 13	712.040.6	1 - 13	712.716.1	5 - 4	712.750.1	5 - 4	712.950.8	1 - 41
650.829.4	8 - 24	710.021.3	1 - 9	710.942.1	5 - 5	712.040.7	1 - 32	712.716.3	1 - 8	712.750.9	5 - 29	712.950.9	5 - 20

**PARTNUMBER / PAGE INFORMATION**

P/N	PAGE	P/N	PAGE	P/N	PAGE	P/N	PAGE	P/N	PAGE	P/N	PAGE	P/N	PAGE
712.960.4	2 - 12	714.055.4	2 - 14	714.535.9	5 - 30	714.940.8	1 - 41	721.914.0	7 - 63	723.812.0	7 - 50	723.931.9	7 - 55
712.963.1	5 - 4	714.063.1	5 - 5	714.540.9	5 - 30	714.940.9	5 - 21	721.914.9	7 - 65	723.812.9	7 - 54	723.943.0	7 - 51
712.963.7	1 - 33	714.063.2	5 - 6	714.550.9	5 - 30	714.950.1	5 - 6	721.915.0	7 - 63	723.813.0	7 - 50	723.943.9	7 - 55
712.963.8	1 - 41	714.063.7	1 - 34	714.575.9	5 - 30	714.950.2	5 - 7	721.915.9	7 - 65	723.813.9	7 - 54	723.944.0	7 - 51
712.963.9	5 - 20	714.063.9	5 - 21	714.712.2	5 - 7	714.950.7	1 - 34	721.918.0	7 - 63	723.814.0	7 - 50	723.944.9	7 - 55
712.975.1	5 - 4	714.075.1	5 - 5	714.716.2	5 - 7	714.950.8	1 - 41	721.918.9	7 - 65	723.814.9	7 - 54	723.951.0	7 - 51
714.011.0	5 - 5	714.075.2	5 - 6	714.718.2	5 - 7	714.950.9	5 - 21	721.919.0	7 - 63	723.815.0	7 - 50	723.951.9	7 - 55
714.011.2	5 - 6	714.075.7	1 - 34	714.723.2	5 - 7	714.955.4	2 - 14	721.919.9	7 - 65	723.815.9	7 - 54	723.952.0	7 - 51
714.011.9	5 - 21	714.075.9	5 - 21	714.726.2	5 - 7	714.963.1	5 - 6	721.923.0	7 - 63	723.818.0	7 - 50	723.952.9	7 - 55
714.012.1	5 - 5	714.111.9	5 - 29	714.730.2	5 - 7	714.963.2	5 - 7	721.923.9	7 - 65	723.818.9	7 - 54	723.953.0	7 - 51
714.012.2	5 - 6	714.112.9	5 - 29	714.735.2	5 - 7	714.963.7	1 - 34	721.924.0	7 - 63	723.819.0	7 - 50	723.953.9	7 - 55
714.012.3	1 - 10	714.116.9	5 - 29	714.738.2	5 - 7	714.975.1	5 - 6	721.924.9	7 - 65	723.819.9	7 - 54	723.954.0	7 - 51
714.012.4	2 - 14	714.120.9	5 - 29	714.740.2	5 - 7	714.975.2	5 - 7	721.925.0	7 - 63	723.823.0	7 - 50	723.954.9	7 - 55
714.012.5	2 - 19	714.126.9	5 - 29	714.911.0	5 - 6	714.975.7	1 - 34	721.925.9	7 - 65	723.823.9	7 - 54	723.955.0	7 - 51
714.012.6	1 - 16	714.135.9	5 - 29	714.911.2	5 - 7	714.975.9	5 - 21	721.929.0	7 - 63	723.824.0	7 - 50	723.955.9	7 - 55
714.012.7	1 - 34	714.140.9	5 - 29	714.911.9	5 - 21	718.940.1	5 - 37	721.929.9	7 - 65	723.824.9	7 - 54	723.956.0	7 - 51
714.012.8	1 - 41	714.150.9	5 - 29	714.912.1	5 - 6	718.950.1	5 - 37	721.930.0	7 - 63	723.825.0	7 - 50	723.956.9	7 - 55
714.012.9	5 - 21	714.163.9	5 - 29	714.912.2	5 - 7	718.963.1	5 - 37	721.930.9	7 - 65	723.825.9	7 - 54	723.957.0	7 - 51
714.016.1	5 - 5	714.175.9	5 - 29	714.912.3	1 - 10	721.810.0	7 - 62	721.931.0	7 - 63	723.829.0	7 - 50	723.957.9	7 - 55
714.016.2	5 - 6	714.211.9	5 - 29	714.912.4	2 - 14	721.810.9	7 - 64	721.931.9	7 - 65	723.829.9	7 - 54	723.958.0	7 - 51
714.016.3	1 - 10	714.212.9	5 - 29	714.912.5	2 - 19	721.811.0	7 - 62	721.943.0	7 - 63	723.830.0	7 - 50	723.958.9	7 - 55
714.016.4	2 - 14	714.216.9	5 - 29	714.912.6	1 - 16	721.811.9	7 - 64	721.943.9	7 - 65	723.830.9	7 - 54	726.712.1	6 - 26
714.016.5	2 - 19	714.220.9	5 - 29	714.912.7	1 - 34	721.812.0	7 - 62	721.944.0	7 - 63	723.831.0	7 - 50	726.713.1	6 - 26
714.016.6	1 - 16	714.226.9	5 - 29	714.912.8	1 - 41	721.812.9	7 - 64	721.944.9	7 - 65	723.831.9	7 - 54	726.716.1	6 - 26
714.016.7	1 - 34	714.235.9	5 - 29	714.912.9	5 - 21	721.813.0	7 - 62	721.951.0	7 - 63	723.843.0	7 - 50	726.717.1	6 - 26
714.016.8	1 - 41	714.240.9	5 - 29	714.916.1	5 - 6	721.813.9	7 - 64	721.951.9	7 - 65	723.843.9	7 - 54	726.720.1	6 - 26
714.016.9	5 - 21	714.250.9	5 - 29	714.916.2	5 - 7	721.814.0	7 - 62	723.611.0	7 - 51	723.844.0	7 - 50	726.722.1	6 - 26
714.020.1	5 - 5	714.275.9	5 - 29	714.916.3	1 - 10	721.814.9	7 - 64	723.611.9	7 - 55	723.844.9	7 - 54	726.725.1	6 - 26
714.020.2	5 - 6	714.411.0	5 - 6	714.916.4	2 - 14	721.815.0	7 - 62	723.612.0	7 - 51	723.851.0	7 - 50	726.728.1	6 - 26
714.020.3	1 - 10	714.411.2	5 - 7	714.916.5	2 - 19	721.815.9	7 - 64	723.612.9	7 - 55	723.851.9	7 - 54	726.732.1	6 - 26
714.020.4	2 - 14	714.411.9	5 - 21	714.916.6	1 - 16	721.818.0	7 - 62	723.613.0	7 - 51	723.852.0	7 - 50	726.735.1	6 - 26
714.020.5	2 - 19	714.412.1	5 - 6	714.916.7	1 - 34	721.818.9	7 - 64	723.613.9	7 - 55	723.852.9	7 - 54	726.740.1	6 - 26
714.020.6	1 - 16	714.412.2	5 - 7	714.916.8	1 - 41	721.819.0	7 - 62	723.614.0	7 - 51	723.853.0	7 - 50	726.745.1	6 - 26
714.020.7	1 - 34	714.412.9	5 - 21	714.916.9	5 - 21	721.819.9	7 - 64	723.614.9	7 - 55	723.853.9	7 - 54	726.750.1	6 - 26
714.020.8	1 - 41	714.416.1	5 - 6	714.920.1	5 - 6	721.823.0	7 - 62	723.615.0	7 - 51	723.854.0	7 - 50	732.016.4	2 - 23
714.020.9	5 - 21	714.416.2	5 - 7	714.920.2	5 - 7	721.823.9	7 - 64	723.615.9	7 - 55	723.855.0	7 - 50	732.017.4	2 - 23
714.026.1	5 - 5	714.416.9	5 - 21	714.920.3	1 - 10	721.824.0	7 - 62	723.618.0	7 - 51	723.856.0	7 - 50	732.020.4	2 - 23
714.026.2	5 - 6	714.420.1	5 - 6	714.920.4	2 - 14	721.824.9	7 - 64	723.618.9	7 - 55	723.857.0	7 - 50	732.025.4	2 - 23
714.026.3	1 - 10	714.420.2	5 - 7	714.920.5	2 - 19	721.825.0	7 - 62	723.619.0	7 - 51	723.858.0	7 - 50	732.032.4	2 - 23
714.026.4	2 - 14	714.420.9	5 - 21	714.920.6	1 - 16	721.825.9	7 - 64	723.619.9	7 - 55	723.912.0	7 - 51	732.416.4	2 - 24
714.026.5	2 - 19	714.426.1	5 - 6	714.920.7	1 - 34	721.829.0	7 - 62	723.623.0	7 - 51	723.912.9	7 - 55	732.417.4	2 - 24
714.026.6	1 - 16	714.426.2	5 - 7	714.920.8	1 - 41	721.829.9	7 - 64	723.623.9	7 - 55	723.913.0	7 - 51	732.420.4	2 - 24
714.026.7	1 - 34	714.426.9	5 - 21	714.920.9	5 - 21	721.830.0	7 - 62	723.624.0	7 - 51	723.913.9	7 - 55	732.425.4	2 - 24
714.026.8	1 - 41	714.435.1	5 - 6	714.926.1	5 - 6	721.830.9	7 - 64	723.624.9	7 - 55	723.914.0	7 - 51	732.432.4	2 - 24
714.026.9	5 - 21	714.435.2	5 - 7	714.926.2	5 - 7	721.831.0	7 - 62	723.625.0	7 - 51	723.914.9	7 - 55	732.916.4	2 - 24
714.035.1	5 - 5	714.435.9	5 - 21	714.926.3	1 - 10	721.831.9	7 - 64	723.625.9	7 - 55	723.915.0	7 - 51	732.917.4	2 - 24
714.035.2	5 - 6	714.440.1	5 - 6	714.926.4	2 - 14	721.843.0	7 - 62	723.629.0	7 - 51	723.915.9	7 - 55	732.920.4	2 - 24
714.035.4	2 - 14	714.440.2	5 - 7	714.926.5	2 - 19	721.843.9	7 - 64	723.629.9	7 - 55	723.918.0	7 - 51	732.925.4	2 - 24
714.035.6	1 - 16	714.440.9	5 - 21	714.926.6	1 - 16	721.844.0	7 - 62	723.630.0	7 - 51	723.918.9	7 - 55	732.932.4	2 - 24
714.035.7	1 - 34	714.450.1	5 - 6	714.926.7	1 - 34	721.844.9	7 - 64	723.630.9	7 - 55	723.919.0	7 - 51	733.016.4	2 - 23
714.035.8	1 - 41	714.450.2	5 - 7	714.926.8	1 - 41	721.851.0	7 - 62	723.631.0	7 - 51	723.919.9	7 - 55	733.020.4	2 - 23
714.035.9	5 - 21	714.450.9	5 - 21	714.926.9	5 - 21	721.851.9	7 - 64	723.631.9	7 - 55	723.923.0	7 - 51	733.025.4	2 - 23
714.040.1	5 - 5	714.463.1	5 - 6	714.935.1	5 - 6	721.852.0	7 - 62	723.643.0	7 - 51	723.923.9	7 - 55	733.032.4	2 - 23
714.040.2	5 - 6	714.463.2	5 - 7	714.935.2	5 - 7	721.852.9	7 - 64	723.643.9	7 - 55	723.924.0	7 - 51	736.716.1	6 - 27
714.040.7	1 - 34	714.475.1	5 - 6	714.935.4	2 - 14	721.853.0	7 - 62	723.644.0	7 - 51	723.924.9	7 - 55	736.716.9	6 - 29
714.040.8	1 - 41	714.475.2	5 - 7	714.935.6	1 - 16	721.853.9	7 - 64	723.644.9	7 - 55	723.925.0	7 - 51	736.717.1	6 - 27
714.040.9	5 - 21	714.475.9	5 - 21	714.935.7	1 - 34	721.855.0	7 - 62	723.651.0	7 - 51	723.925.9	7 - 55	736.717.9	6 - 29
714.050.1	5 - 5	714.511.9	5 - 30	714.935.8	1 - 41	721.855.9	7 - 64	723.651.9	7 - 55	723.929.0	7 - 51	736.720.1	6 - 27
714.050.2	5 - 6	714.512.9	5 - 30	714.935.9	5 - 21	721.912.0	7 - 63	723.652.0	7 - 51	723.929.9	7 - 55	736.720.9	6 - 29
714.050.7	1 - 34	714.516.9	5 - 30	714.940.1	5 - 6	721.912.9	7 - 65	723.652.9	7 - 55	723.930.0	7 - 51	736.722.1	6 - 27
714.050.8	1 - 41	714.520.9	5 - 30	714.940.2	5 - 7	721.913.0	7 - 63	723.653.0	7 - 51	723.930.9	7 - 55	736.722.9	6 - 29
714.050.9	5 - 21	714.526.9	5 - 30	714.940.7	1 - 34	721.913.9	7 - 65	723.653.9	7 - 55	723.931.0	7 - 51	736.725.1	6 - 27

PARTNUMBER / PAGE INFORMATION

P/N	PAGE	P/N	PAGE	P/N	PAGE	P/N	PAGE	P/N	PAGE	P/N	PAGE	P/N	PAGE
736.725.9	6 - 29	781.320.8	7 - 79	781.826.8	7 - 78	782.416.8	7 - 76	782.720.8	7 - 78	784.020.7	1 - 35	798.325.0	9 - 22
736.728.1	6 - 27	781.325.0	7 - 72	781.828.0	7 - 71	782.420.0	7 - 70	782.726.0	7 - 71	784.026.0	6 - 17	798.325.3	9 - 22
736.728.9	6 - 29	781.325.8	7 - 79	781.828.8	7 - 78	782.420.8	7 - 76	782.726.8	7 - 78	784.026.3	1 - 10	798.332.0	9 - 22
736.732.1	6 - 27	781.332.0	7 - 72	781.835.0	7 - 71	782.426.0	7 - 70	782.735.0	7 - 71	784.026.4	2 - 15	798.332.3	9 - 22
736.732.9	6 - 29	781.332.8	7 - 79	781.835.8	7 - 78	782.426.8	7 - 76	782.735.8	7 - 78	784.026.6	1 - 16	798.340.0	9 - 22
736.735.1	6 - 27	781.340.0	7 - 72	781.838.0	7 - 71	782.435.0	7 - 70	782.740.0	7 - 71	784.026.7	1 - 35	798.340.3	9 - 22
736.735.9	6 - 29	781.340.8	7 - 79	781.838.8	7 - 78	782.435.8	7 - 76	782.740.8	7 - 78	784.035.0	6 - 17	798.350.0	9 - 22
736.740.1	6 - 27	781.350.0	7 - 72	781.840.0	7 - 71	782.440.0	7 - 70	782.750.0	7 - 71	784.035.4	2 - 15	798.350.3	9 - 22
736.740.9	6 - 29	781.350.8	7 - 79	781.840.8	7 - 78	782.440.8	7 - 76	782.750.8	7 - 78	784.035.6	1 - 16	798.363.0	9 - 22
736.745.1	6 - 27	781.363.0	7 - 72	782.111.0	7 - 69	782.450.0	7 - 70	782.816.0	7 - 71	784.035.7	1 - 35	798.363.3	9 - 22
736.745.9	6 - 29	781.363.8	7 - 79	782.111.8	7 - 76	782.450.8	7 - 76	782.816.8	7 - 78	784.040.0	6 - 17	799.801.0	9 - 21
736.750.1	6 - 27	781.375.0	7 - 72	782.116.0	7 - 69	782.516.0	7 - 70	782.820.0	7 - 71	784.040.7	1 - 35	799.802.0	9 - 21
736.750.9	6 - 29	781.375.8	7 - 79	782.116.8	7 - 76	782.516.8	7 - 77	782.820.8	7 - 78	784.045.4	2 - 15	799.803.0	9 - 21
738.712.2	6 - 28	781.416.0	7 - 72	782.121.0	7 - 69	782.520.0	7 - 70	782.822.0	7 - 71	784.050.0	6 - 17	799.804.0	9 - 21
738.716.2	6 - 28	781.416.8	7 - 79	782.121.8	7 - 76	782.520.8	7 - 77	782.822.8	7 - 78	784.050.7	1 - 35	799.805.0	9 - 21
738.718.2	6 - 28	781.420.0	7 - 72	782.129.0	7 - 69	782.522.0	7 - 70	782.825.0	7 - 71	785.012.4	2 - 24	799.806.0	9 - 21
738.720.2	6 - 28	781.420.8	7 - 79	782.129.8	7 - 76	782.522.8	7 - 77	782.825.8	7 - 78	785.016.4	2 - 24	799.807.0	9 - 21
738.723.2	6 - 28	781.426.0	7 - 72	782.136.0	7 - 69	782.524.0	7 - 70	782.828.0	7 - 71	785.020.4	2 - 24	801.107.0	9 - 3
738.726.2	6 - 28	781.426.8	7 - 79	782.136.8	7 - 76	782.524.8	7 - 77	782.828.8	7 - 78	785.026.4	2 - 24	801.107.5	9 - 3
738.730.2	6 - 28	781.435.0	7 - 72	782.216.0	7 - 68	782.525.0	7 - 70	782.835.0	7 - 71	785.234.0	5 - 15	801.110.0	9 - 3
738.735.2	6 - 28	781.435.8	7 - 79	782.216.8	7 - 75	782.525.8	7 - 77	782.835.8	7 - 78	785.235.0	5 - 15	801.110.5	9 - 3
738.738.2	6 - 28	781.440.0	7 - 72	782.220.0	7 - 68	782.527.0	7 - 70	782.836.0	7 - 71	785.243.0	5 - 15	801.112.0	9 - 3
738.740.2	6 - 28	781.440.8	7 - 79	782.220.8	7 - 75	782.527.8	7 - 77	782.836.8	7 - 78	785.244.0	5 - 15	801.112.5	9 - 3
742.015.9	5 - 35	781.450.0	7 - 72	782.225.0	7 - 68	782.528.0	7 - 70	782.838.0	7 - 71	785.327.0	5 - 15	801.117.0	9 - 3
742.016.9	5 - 35	781.450.8	7 - 79	782.225.8	7 - 75	782.528.8	7 - 77	782.838.8	7 - 78	785.336.6	5 - 15	801.117.5	9 - 3
742.020.9	5 - 35	781.511.0	7 - 73	782.232.0	7 - 68	782.532.0	7 - 70	782.840.0	7 - 71	785.338.0	5 - 15	801.123.0	9 - 3
742.025.9	5 - 35	781.511.8	7 - 79	782.232.8	7 - 75	782.532.8	7 - 77	782.840.8	7 - 78	785.437.5	5 - 15	801.123.5	9 - 3
742.032.9	5 - 35	781.513.0	7 - 73	782.240.0	7 - 68	782.534.0	7 - 70	782.845.0	7 - 71	785.448.0	5 - 15	801.129.0	9 - 3
742.040.9	5 - 35	781.513.8	7 - 79	782.240.8	7 - 75	782.534.8	7 - 77	782.845.8	7 - 78	785.465.0	5 - 15	801.129.5	9 - 3
742.050.9	5 - 35	781.516.0	7 - 73	782.250.0	7 - 68	782.538.0	7 - 70	782.850.0	7 - 71	785.466.0	5 - 15	801.136.0	9 - 3
742.063.9	5 - 35	781.516.8	7 - 79	782.250.8	7 - 75	782.538.8	7 - 77	782.850.8	7 - 78	797.701.0	9 - 21	801.136.5	9 - 3
781.111.0	7 - 69	781.521.0	7 - 73	782.311.0	7 - 70	782.540.0	7 - 70	782.916.0	7 - 73	797.702.0	9 - 21	801.148.0	9 - 3
781.111.8	7 - 75	781.521.8	7 - 79	782.311.8	7 - 77	782.540.8	7 - 77	782.920.0	7 - 73	797.703.0	9 - 21	801.148.5	9 - 3
781.115.0	7 - 69	781.529.0	7 - 73	782.313.0	7 - 70	782.548.0	7 - 70	782.925.0	7 - 73	797.704.0	9 - 21	801.207.0	9 - 5
781.115.8	7 - 75	781.529.8	7 - 79	782.313.8	7 - 77	782.548.8	7 - 77	782.932.0	7 - 73	797.705.0	9 - 21	801.207.5	9 - 5
781.116.0	7 - 69	781.536.0	7 - 73	782.316.0	7 - 70	782.550.0	7 - 70	782.940.0	7 - 73	797.706.0	9 - 21	801.210.0	9 - 5
781.116.8	7 - 75	781.536.8	7 - 79	782.316.8	7 - 77	782.550.8	7 - 77	782.950.0	7 - 73	797.707.0	9 - 21	801.210.5	9 - 5
781.118.0	7 - 69	781.542.0	7 - 73	782.320.0	7 - 70	782.552.0	7 - 70	782.963.0	7 - 73	797.708.0	9 - 21	801.212.0	9 - 5
781.118.8	7 - 75	781.542.8	7 - 79	782.320.8	7 - 77	782.552.8	7 - 77	782.975.0	7 - 73	797.709.0	9 - 21	801.212.5	9 - 5
781.121.0	7 - 69	781.548.0	7 - 73	782.321.0	7 - 70	782.560.0	7 - 70	783.016.0	6 - 18	797.710.0	9 - 21	801.217.0	9 - 5
781.121.8	7 - 75	781.548.8	7 - 79	782.321.8	7 - 77	782.560.8	7 - 77	783.020.0	6 - 18	797.711.0	9 - 21	801.217.5	9 - 5
781.129.0	7 - 69	781.716.0	7 - 72	782.326.0	7 - 70	782.563.0	7 - 70	783.025.0	6 - 18	797.712.0	9 - 21	801.223.0	9 - 5
781.129.8	7 - 75	781.716.8	7 - 79	782.326.8	7 - 77	782.563.8	7 - 77	783.032.0	6 - 18	797.713.0	9 - 21	801.223.5	9 - 5
781.136.0	7 - 69	781.720.0	7 - 72	782.329.0	7 - 70	782.612.0	7 - 69	784.010.0	6 - 17	797.714.0	9 - 21	801.229.0	9 - 5
781.136.8	7 - 75	781.720.8	7 - 79	782.329.8	7 - 77	782.612.8	7 - 76	784.010.3	1 - 10	797.715.0	9 - 21	801.229.5	9 - 5
781.148.0	7 - 69	781.726.0	7 - 72	782.330.0	7 - 70	782.616.0	7 - 69	784.010.4	2 - 15	797.801.0	9 - 21	801.236.0	9 - 5
781.148.8	7 - 75	781.726.8	7 - 79	782.330.8	7 - 77	782.616.8	7 - 76	784.010.6	1 - 16	797.802.0	9 - 21	801.236.5	9 - 5
781.220.0	7 - 68	781.735.0	7 - 72	782.336.0	7 - 70	782.618.0	7 - 69	784.010.7	1 - 35	797.803.0	9 - 21	801.248.0	9 - 5
781.220.8	7 - 75	781.735.8	7 - 79	782.336.8	7 - 77	782.618.8	7 - 76	784.012.0	6 - 17	797.804.0	9 - 21	801.248.5	9 - 5
781.225.0	7 - 68	781.740.0	7 - 72	782.340.0	7 - 70	782.620.0	7 - 69	784.012.3	1 - 10	797.805.0	9 - 21	801.305.0	9 - 4
781.225.8	7 - 75	781.740.8	7 - 79	782.340.8	7 - 77	782.620.8	7 - 76	784.012.4	2 - 15	797.806.0	9 - 21	801.305.5	9 - 4
781.232.0	7 - 68	781.750.0	7 - 72	782.342.0	7 - 70	782.626.0	7 - 69	784.012.6	1 - 16	797.807.0	9 - 21	801.307.0	9 - 4
781.232.8	7 - 75	781.750.8	7 - 79	782.342.8	7 - 77	782.626.8	7 - 76	784.012.7	1 - 35	797.808.0	9 - 21	801.307.5	9 - 4
781.240.0	7 - 68	781.816.0	7 - 71	782.348.0	7 - 70	782.635.0	7 - 69	784.016.0	6 - 17	797.809.0	9 - 21	801.310.0	9 - 4
781.240.8	7 - 75	781.816.8	7 - 78	782.348.8	7 - 77	782.635.8	7 - 76	784.016.3	1 - 10	797.810.0	9 - 21	801.310.5	9 - 4
781.250.0	7 - 68	781.818.0	7 - 71	782.411.0	7 - 70	782.640.0	7 - 69	784.016.4	2 - 15	797.811.0	9 - 21	801.312.0	9 - 4
781.250.8	7 - 75	781.818.8	7 - 78	782.411.8	7 - 76	782.640.8	7 - 76	784.016.6	1 - 16	798.312.0	9 - 22	801.312.5	9 - 4
781.263.0	7 - 68	781.820.0	7 - 71	782.412.0	7 - 70	782.650.0	7 - 69	784.016.7	1 - 35	798.312.3	9 - 22	801.317.0	9 - 4
781.263.8	7 - 75	781.820.8	7 - 78	782.412.8	7 - 76	782.650.8	7 - 76	784.020.0	6 - 17	798.316.0	9 - 22	801.317.5	9 - 4
781.316.0	7 - 72	781.822.0	7 - 71	782.413.0	7 - 70	782.716.0	7 - 71	784.020.3	1 - 10	798.316.3	9 - 22	801.323.0	9 - 4
781.316.8	7 - 79	781.822.8	7 - 78	782.413.8	7 - 76	782.716.8	7 - 78	784.020.4	2 - 15	798.320.0	9 - 22	801.323.5	9 - 4
781.320.0	7 - 72	781.826.0	7 - 71	782.416.0	7 - 70	782.720.0	7 - 71	784.020.6	1 - 16	798.320.3	9 - 22	801.329.0	9 - 4



PARTNUMBER / PAGE INFORMATION

P/N	PAGE	P/N	PAGE	P/N	PAGE	P/N	PAGE	P/N	PAGE	P/N	PAGE	P/N	PAGE
801329.5	9 - 4	802.810.0	9 - 9	810.042.7	1 - 38	810.715.7	1 - 38	812.120.9	5 - 32	812.420.9	5 - 24	812.940.1	5 - 13
801336.0	9 - 4	802.810.5	9 - 9	810.042.9	5 - 25	810.716.1	5 - 17	812.125.9	5 - 32	812.425.1	5 - 13	812.950.1	5 - 13
801336.5	9 - 4	802.812.0	9 - 9	810.048.1	5 - 15	810.716.7	1 - 38	812.132.9	5 - 32	812.425.9	5 - 24	812.963.1	5 - 13
801348.0	9 - 4	802.812.5	9 - 9	810.048.7	1 - 38	810.721.1	5 - 17	812.214.9	5 - 32	812.432.1	5 - 13	813.015.0	5 - 10
801348.5	9 - 4	802.814.0	9 - 9	810.048.9	5 - 25	810.721.7	1 - 38	812.215.9	5 - 32	812.440.1	5 - 13	813.015.3	1 - 8
801507.0	9 - 6	802.814.5	9 - 9	810.116.9	5 - 33	810.729.1	5 - 17	812.216.9	5 - 32	812.450.1	5 - 13	813.015.4	2 - 12
801507.5	9 - 6	802.817.0	9 - 9	810.121.9	5 - 33	810.729.7	1 - 38	812.217.9	5 - 32	812.463.1	5 - 13	813.015.6	1 - 14
801510.0	9 - 6	802.817.5	9 - 9	810.129.9	5 - 33	810.911.1	5 - 16	812.220.9	5 - 32	812.514.9	5 - 33	813.015.7	1 - 32
801510.5	9 - 6	802.819.0	9 - 9	810.303.2	6 - 3	810.911.9	5 - 26	812.225.9	5 - 32	812.515.9	5 - 33	813.016.0	5 - 10
801512.0	9 - 6	802.819.5	9 - 9	810.303.6	6 - 3	810.912.1	5 - 16	812.315.1	5 - 13	812.516.9	5 - 33	813.016.3	1 - 8
801512.5	9 - 6	802.823.0	9 - 9	810.303.7	6 - 4	810.912.9	5 - 26	812.315.7	1 - 37	812.517.9	5 - 33	813.016.4	2 - 12
801517.0	9 - 6	802.823.5	9 - 9	810.304.1	6 - 3	810.913.1	5 - 16	812.316.1	5 - 13	812.520.9	5 - 33	813.016.5	2 - 17
801517.5	9 - 6	802.826.0	9 - 9	810.304.5	6 - 4	810.914.1	5 - 16	812.316.5	2 - 18	812.525.9	5 - 33	813.016.6	1 - 14
801523.0	9 - 6	802.826.5	9 - 9	810.304.6	6 - 3	810.916.1	5 - 16	812.316.7	1 - 37	812.615.2	5 - 14	813.016.7	1 - 32
801523.5	9 - 6	802.829.0	9 - 9	810.304.7	6 - 4	810.916.9	5 - 26	812.320.1	5 - 13	812.616.1	5 - 14	813.017.0	5 - 10
801529.0	9 - 6	802.829.5	9 - 9	810.311.1	5 - 16	810.921.1	5 - 16	812.320.5	2 - 18	812.617.1	5 - 14	813.020.0	5 - 10
801529.5	9 - 6	802.836.0	9 - 9	810.311.7	1 - 38	810.921.9	5 - 26	812.320.7	1 - 37	812.620.1	5 - 14	813.020.3	1 - 8
801536.0	9 - 6	802.836.5	9 - 9	810.312.1	5 - 16	810.929.1	5 - 16	812.322.1	6 - 5	812.622.1	5 - 14	813.020.4	2 - 12
801536.5	9 - 6	802.848.0	9 - 9	810.312.7	1 - 38	810.929.9	5 - 26	812.322.6	6 - 5	812.628.1	5 - 14	813.020.5	2 - 17
801707.0	9 - 7	802.848.5	9 - 9	810.313.1	5 - 16	810.936.1	5 - 16	812.322.7	6 - 5	812.635.1	5 - 14	813.020.6	1 - 14
801710.0	9 - 7	802.907.0	9 - 10	810.313.7	1 - 38	810.942.1	5 - 16	812.323.1	6 - 3	812.715.2	5 - 14	813.020.7	1 - 32
801712.0	9 - 7	802.910.0	9 - 10	810.314.1	5 - 16	810.948.1	5 - 16	812.323.5	6 - 4	812.715.7	1 - 37	813.025.0	5 - 10
801717.0	9 - 7	802.913.0	9 - 10	810.314.7	1 - 38	812.011.2	5 - 12	812.323.6	6 - 3	812.715.9	5 - 25	813.025.3	1 - 8
801723.0	9 - 7	802.916.0	9 - 10	810.316.1	5 - 16	812.012.1	5 - 12	812.323.7	6 - 4	812.716.1	5 - 14	813.025.4	2 - 12
801729.0	9 - 7	802.917.0	9 - 10	810.316.7	1 - 38	812.012.2	5 - 12	812.325.1	5 - 13	812.716.2	5 - 14	813.025.5	2 - 17
801736.0	9 - 7	802.922.0	9 - 10	810.321.1	5 - 16	812.012.5	2 - 16	812.325.5	2 - 18	812.716.7	1 - 37	813.025.6	1 - 14
801748.0	9 - 7	802.923.0	9 - 10	810.321.7	1 - 38	812.013.2	5 - 12	812.325.7	1 - 37	812.716.9	5 - 25	813.025.7	1 - 32
802207.0	9 - 11	802.926.0	9 - 10	810.329.1	5 - 16	812.014.1	5 - 12	812.326.1	6 - 5	812.717.1	5 - 14	813.032.0	5 - 10
802210.0	9 - 11	802.929.0	9 - 10	810.329.7	1 - 38	812.014.2	5 - 12	812.326.6	6 - 5	812.717.7	1 - 37	813.032.3	1 - 8
802213.0	9 - 11	802.936.0	9 - 10	810.336.1	5 - 16	812.014.7	1 - 36	812.326.7	6 - 5	812.717.9	5 - 25	813.032.4	2 - 12
802216.0	9 - 11	802.948.0	9 - 10	810.336.7	1 - 38	812.014.9	5 - 24	812.327.1	6 - 3	812.720.1	5 - 14	813.032.5	2 - 17
802217.0	9 - 11	810.007.1	5 - 15	810.342.1	5 - 16	812.015.1	5 - 12	812.327.5	6 - 4	812.720.2	5 - 14	813.032.6	1 - 14
802222.0	9 - 11	810.007.2	5 - 15	810.342.7	1 - 38	812.015.2	5 - 12	812.327.6	6 - 3	812.720.7	1 - 37	813.032.7	1 - 32
802223.0	9 - 11	810.009.1	5 - 15	810.348.1	5 - 16	812.015.7	1 - 36	812.327.7	6 - 4	812.720.9	5 - 25	813.040.0	5 - 10
802226.0	9 - 11	810.009.2	5 - 15	810.348.7	1 - 38	812.015.9	5 - 24	812.329.1	6 - 3	812.722.1	5 - 14	813.040.6	1 - 14
802229.0	9 - 11	810.009.7	1 - 38	810.411.1	5 - 16	812.016.1	5 - 12	812.329.5	6 - 4	812.725.2	5 - 14	813.040.7	1 - 32
802236.0	9 - 11	810.010.1	5 - 15	810.412.1	5 - 16	812.016.7	1 - 36	812.329.6	6 - 3	812.725.7	1 - 37	813.045.4	2 - 12
802248.0	9 - 11	810.010.7	1 - 38	810.413.1	5 - 16	812.016.9	5 - 24	812.329.7	6 - 4	812.728.1	5 - 14	813.050.0	5 - 10
802307.0	9 - 12	810.011.1	5 - 15	810.414.1	5 - 16	812.017.1	5 - 12	812.332.1	5 - 13	812.732.2	5 - 14	813.050.7	1 - 32
802310.0	9 - 12	810.011.7	1 - 38	810.416.1	5 - 16	812.017.7	1 - 36	812.332.5	2 - 18	812.732.7	1 - 37	813.060.4	2 - 12
802313.0	9 - 12	810.011.9	5 - 25	810.421.1	5 - 16	812.017.9	5 - 24	812.332.7	1 - 37	812.735.1	5 - 14	813.063.0	5 - 10
802316.0	9 - 12	810.012.1	5 - 15	810.429.1	5 - 16	812.020.1	5 - 12	812.338.1	6 - 3	812.740.1	5 - 14	813.063.7	1 - 32
802317.0	9 - 12	810.012.7	1 - 38	810.436.1	5 - 16	812.020.7	1 - 36	812.338.6	6 - 3	812.740.2	5 - 14	813.415.0	5 - 10
802322.0	9 - 12	810.012.9	5 - 25	810.442.1	5 - 16	812.020.9	5 - 24	812.338.7	6 - 4	812.740.7	1 - 37	813.416.0	5 - 10
802323.0	9 - 12	810.013.1	5 - 15	810.448.1	5 - 16	812.025.1	5 - 12	812.340.1	5 - 13	812.745.1	5 - 14	813.420.0	5 - 10
802326.0	9 - 12	810.013.7	1 - 38	810.513.9	5 - 33	812.025.7	1 - 36	812.340.7	1 - 37	812.750.2	5 - 14	813.425.0	5 - 10
802329.0	9 - 12	810.013.9	5 - 25	810.514.9	5 - 33	812.025.9	5 - 24	812.342.1	6 - 3	812.750.7	1 - 37	813.432.0	5 - 10
802336.0	9 - 12	810.014.1	5 - 15	810.516.9	5 - 33	812.032.1	5 - 12	812.342.6	6 - 3	812.763.2	5 - 14	813.915.0	5 - 11
802348.0	9 - 12	810.014.9	5 - 25	810.609.1	5 - 17	812.032.7	1 - 36	812.342.7	6 - 4	812.763.7	1 - 37	813.915.3	1 - 9
802510.0	9 - 8	810.016.1	5 - 15	810.611.1	5 - 17	812.032.9	5 - 24	812.350.1	5 - 13	812.914.1	5 - 13	813.915.4	2 - 13
802512.0	9 - 8	810.016.7	1 - 38	810.612.1	5 - 17	812.040.1	5 - 12	812.350.7	1 - 37	812.914.9	5 - 25	813.915.6	1 - 15
802517.0	9 - 8	810.016.9	5 - 25	810.615.1	5 - 17	812.040.5	2 - 16	812.363.1	5 - 13	812.915.1	5 - 13	813.915.7	1 - 33
802523.0	9 - 8	810.021.1	5 - 15	810.616.1	5 - 17	812.040.7	1 - 36	812.363.7	1 - 37	812.915.9	5 - 25	813.916.0	5 - 11
802529.0	9 - 8	810.021.7	1 - 38	810.621.1	5 - 17	812.040.9	5 - 24	812.414.1	5 - 13	812.916.1	5 - 13	813.916.3	1 - 9
802536.0	9 - 8	810.021.9	5 - 25	810.629.1	5 - 17	812.050.1	5 - 12	812.414.9	5 - 24	812.916.9	5 - 25	813.916.4	2 - 13
802548.0	9 - 8	810.029.1	5 - 15	810.709.1	5 - 17	812.050.7	1 - 36	812.415.1	5 - 13	812.917.1	5 - 13	813.916.5	2 - 18
802805.0	9 - 9	810.029.7	1 - 38	810.709.7	1 - 38	812.063.1	5 - 12	812.415.9	5 - 24	812.917.9	5 - 25	813.916.6	1 - 15
802805.5	9 - 9	810.029.9	5 - 25	810.711.1	5 - 17	812.063.7	1 - 36	812.416.1	5 - 13	812.920.1	5 - 13	813.916.7	1 - 33
802806.0	9 - 9	810.036.1	5 - 15	810.711.7	1 - 38	812.114.9	5 - 32	812.416.9	5 - 24	812.920.9	5 - 25	813.920.0	5 - 11
802806.5	9 - 9	810.036.7	1 - 38	810.712.1	5 - 17	812.115.9	5 - 32	812.417.1	5 - 13	812.925.1	5 - 13	813.920.3	1 - 9
802807.0	9 - 9	810.036.9	5 - 25	810.712.7	1 - 38	812.116.9	5 - 32	812.417.9	5 - 24	812.925.9	5 - 25	813.920.4	2 - 13
802807.5	9 - 9	810.042.1	5 - 15	810.715.1	5 - 17	812.117.9	5 - 32	812.420.1	5 - 13	812.932.1	5 - 13	813.920.5	2 - 18



PARTNUMBER / PAGE INFORMATION

P/N	PAGE	P/N	PAGE	P/N	PAGE	P/N	PAGE	P/N	PAGE	P/N	PAGE	P/N	PAGE
813.920.6	1 - 15	814.420.1	5 - 18	815.048.3	6 - 10	817.263.6	1 - 31	822.009.9	7 - 19	822.108.9	7 - 29	822.206.9	7 - 22
813.920.7	1 - 33	814.420.9	5 - 26	815.048.5	6 - 19	817.275.6	1 - 31	822.010.0	7 - 14	822.109.0	7 - 24	822.207.0	7 - 17
813.925.0	5 - 11	814.426.1	5 - 18	815.048.6	8 - 12	817.512.0	10 - 8	822.010.3	7 - 15	822.109.3	7 - 25	822.207.9	7 - 22
813.925.3	1 - 9	814.435.1	5 - 18	815.063.2	6 - 10	817.516.0	10 - 8	822.010.6	7 - 20	822.109.6	7 - 30	822.209.0	7 - 17
813.925.4	2 - 13	814.440.1	5 - 18	815.063.5	6 - 19	817.520.0	10 - 8	822.010.9	7 - 19	822.109.9	7 - 29	822.209.3	7 - 18
813.925.5	2 - 18	814.450.1	5 - 18	815.075.2	6 - 10	817.526.0	10 - 8	822.011.0	7 - 14	822.110.0	7 - 24	822.209.6	7 - 23
813.925.6	1 - 15	814.511.9	5 - 33	815.075.5	6 - 19	817.535.0	10 - 8	822.011.3	7 - 15	822.110.3	7 - 25	822.209.9	7 - 22
813.925.7	1 - 33	814.512.9	5 - 33	815.416.0	6 - 11	817.540.0	10 - 8	822.011.6	7 - 20	822.110.6	7 - 30	822.210.0	7 - 17
813.932.0	5 - 11	814.516.9	5 - 33	815.420.0	6 - 11	817.550.0	10 - 8	822.011.9	7 - 19	822.110.9	7 - 29	822.210.3	7 - 18
813.932.3	1 - 9	814.709.1	5 - 19	815.425.0	6 - 11	817.612.0	10 - 19	822.012.0	7 - 14	822.111.0	7 - 24	822.210.6	7 - 23
813.932.4	2 - 13	814.710.1	5 - 19	815.432.0	6 - 11	817.616.0	10 - 19	822.012.3	7 - 15	822.111.3	7 - 25	822.210.9	7 - 22
813.932.5	2 - 18	814.712.1	5 - 19	815.440.0	6 - 11	817.620.0	10 - 19	822.012.6	7 - 20	822.111.6	7 - 30	822.211.0	7 - 17
813.932.6	1 - 15	814.715.1	5 - 19	815.450.0	6 - 11	817.626.0	10 - 19	822.012.9	7 - 19	822.111.9	7 - 29	822.211.3	7 - 18
813.932.7	1 - 33	814.721.1	5 - 19	815.463.0	6 - 11	817.635.0	10 - 19	822.013.0	7 - 14	822.112.0	7 - 24	822.211.6	7 - 23
814.011.1	5 - 17	814.911.1	5 - 18	815.507.0	6 - 11	817.640.0	10 - 19	822.013.3	7 - 15	822.112.3	7 - 25	822.211.9	7 - 22
814.011.7	1 - 39	814.911.9	5 - 27	815.509.0	6 - 11	817.650.0	10 - 19	822.013.6	7 - 20	822.112.6	7 - 30	822.212.0	7 - 17
814.011.9	5 - 26	814.912.1	5 - 18	815.511.0	6 - 11	817.710.0	1 - 28	822.013.9	7 - 19	822.112.9	7 - 29	822.212.3	7 - 18
814.012.1	5 - 17	814.912.9	5 - 27	815.513.0	6 - 11	817.712.0	1 - 28	822.014.0	7 - 14	822.113.0	7 - 24	822.212.6	7 - 23
814.012.7	1 - 39	814.916.1	5 - 18	815.516.0	6 - 11	817.716.0	1 - 28	822.014.3	7 - 15	822.113.3	7 - 25	822.212.9	7 - 22
814.012.9	5 - 26	814.916.9	5 - 27	815.521.0	6 - 11	817.720.0	1 - 28	822.014.6	7 - 20	822.113.6	7 - 30	822.213.0	7 - 17
814.016.1	5 - 17	814.920.1	5 - 18	815.529.0	6 - 11	817.726.0	1 - 28	822.014.9	7 - 19	822.113.9	7 - 29	822.213.3	7 - 18
814.016.7	1 - 39	814.920.9	5 - 27	815.536.0	6 - 11	817.735.0	1 - 28	822.015.0	7 - 14	822.114.0	7 - 24	822.213.6	7 - 23
814.016.9	5 - 26	814.926.1	5 - 18	815.542.0	6 - 11	817.740.0	1 - 28	822.015.3	7 - 15	822.114.3	7 - 25	822.213.9	7 - 22
814.020.1	5 - 17	814.926.9	5 - 27	815.548.0	6 - 11	817.750.0	1 - 28	822.015.6	7 - 20	822.114.6	7 - 30	822.214.0	7 - 17
814.020.7	1 - 39	814.935.1	5 - 18	815.616.0	6 - 11	817.816.0	2 - 16	822.015.9	7 - 19	822.114.9	7 - 29	822.214.3	7 - 18
814.020.9	5 - 26	814.940.1	5 - 18	815.620.0	6 - 11	817.820.0	2 - 16	822.018.0	7 - 14	822.115.0	7 - 24	822.214.6	7 - 23
814.026.1	5 - 17	814.950.1	5 - 18	815.626.0	6 - 11	817.825.0	2 - 16	822.018.3	7 - 15	822.115.3	7 - 25	822.214.9	7 - 22
814.026.7	1 - 39	815.006.0	6 - 10	815.635.0	6 - 11	817.832.0	2 - 16	822.018.6	7 - 20	822.115.6	7 - 30	822.215.0	7 - 17
814.026.9	5 - 26	815.010.0	6 - 10	815.640.0	6 - 11	818.914.1	5 - 37	822.018.9	7 - 19	822.115.9	7 - 29	822.215.3	7 - 18
814.035.1	5 - 17	815.011.0	6 - 10	815.650.0	6 - 11	818.915.1	5 - 37	822.019.0	7 - 14	822.118.0	7 - 24	822.215.6	7 - 23
814.035.7	1 - 39	815.011.2	6 - 10	815.663.0	6 - 11	818.916.1	5 - 37	822.019.3	7 - 15	822.118.3	7 - 25	822.215.9	7 - 22
814.040.1	5 - 17	815.011.3	6 - 10	815.675.0	6 - 11	818.917.1	5 - 37	822.019.6	7 - 20	822.118.6	7 - 30	822.218.0	7 - 17
814.040.7	1 - 39	815.011.5	6 - 19	817.012.0	2 - 11	818.920.1	5 - 37	822.019.9	7 - 19	822.118.9	7 - 29	822.218.3	7 - 18
814.050.1	5 - 17	815.011.6	8 - 12	817.016.0	2 - 11	818.925.1	5 - 37	822.023.0	7 - 14	822.119.0	7 - 24	822.218.6	7 - 23
814.050.7	1 - 39	815.011.9	6 - 21	817.020.0	2 - 11	818.932.1	5 - 37	822.023.3	7 - 15	822.119.3	7 - 25	822.218.9	7 - 22
814.111.9	5 - 33	815.016.0	6 - 10	817.025.0	2 - 11	819.212.9	5 - 34	822.023.6	7 - 20	822.119.6	7 - 30	822.219.0	7 - 17
814.112.9	5 - 33	815.016.2	6 - 10	817.032.0	2 - 11	819.216.9	5 - 34	822.023.9	7 - 19	822.119.9	7 - 29	822.219.3	7 - 18
814.116.9	5 - 33	815.016.3	6 - 10	817.112.0	1 - 7	819.411.0	5 - 11	822.024.0	7 - 14	822.123.0	7 - 24	822.219.6	7 - 23
814.120.9	5 - 33	815.016.5	6 - 19	817.116.0	1 - 7	819.412.0	5 - 11	822.024.3	7 - 15	822.123.3	7 - 25	822.219.9	7 - 22
814.126.9	5 - 33	815.016.6	8 - 12	817.120.0	1 - 7	819.416.0	5 - 11	822.024.6	7 - 20	822.123.6	7 - 30	822.223.0	7 - 17
814.311.1	5 - 18	815.016.9	6 - 21	817.125.0	1 - 7	819.420.0	5 - 11	822.024.9	7 - 19	822.123.9	7 - 29	822.223.3	7 - 18
814.311.7	1 - 39	815.021.0	6 - 10	817.132.0	1 - 7	819.426.0	5 - 11	822.025.0	7 - 14	822.124.0	7 - 24	822.223.6	7 - 23
814.312.1	5 - 18	815.021.2	6 - 10	817.206.6	1 - 25	819.512.9	5 - 34	822.025.3	7 - 15	822.124.3	7 - 25	822.223.9	7 - 22
814.312.7	1 - 39	815.021.3	6 - 10	817.206.9	1 - 45	819.516.9	5 - 34	822.025.6	7 - 20	822.124.6	7 - 30	822.224.0	7 - 17
814.316.1	5 - 18	815.021.5	6 - 19	817.209.6	1 - 25	819.911.0	5 - 11	822.025.9	7 - 19	822.124.9	7 - 29	822.224.3	7 - 18
814.316.7	1 - 39	815.021.6	8 - 12	817.209.9	1 - 45	819.912.0	5 - 11	822.029.0	7 - 14	822.125.0	7 - 24	822.224.6	7 - 23
814.320.1	5 - 18	815.021.9	6 - 21	817.210.6	1 - 13	819.912.4	2 - 14	822.029.3	7 - 15	822.125.3	7 - 25	822.224.9	7 - 22
814.320.7	1 - 39	815.029.0	6 - 10	817.210.9	1 - 31	819.916.0	5 - 11	822.029.6	7 - 20	822.125.6	7 - 30	822.225.0	7 - 17
814.326.1	5 - 18	815.029.2	6 - 10	817.213.6	1 - 13	819.916.4	2 - 14	822.029.9	7 - 19	822.125.9	7 - 29	822.225.3	7 - 18
814.326.7	1 - 39	815.029.3	6 - 10	817.213.9	1 - 31	819.920.0	5 - 11	822.030.0	7 - 14	822.129.0	7 - 24	822.225.6	7 - 23
814.335.1	5 - 18	815.029.5	6 - 19	817.216.6	1 - 13	819.920.4	2 - 14	822.030.3	7 - 15	822.129.3	7 - 25	822.225.9	7 - 22
814.335.7	1 - 39	815.029.6	8 - 12	817.216.9	1 - 31	819.926.0	5 - 11	822.030.6	7 - 20	822.129.6	7 - 30	822.229.0	7 - 17
814.340.1	5 - 18	815.029.9	6 - 21	817.220.6	1 - 13	819.926.4	2 - 14	822.030.9	7 - 19	822.129.9	7 - 29	822.229.3	7 - 18
814.340.7	1 - 39	815.036.2	6 - 10	817.220.9	1 - 31	822.006.0	7 - 14	822.031.0	7 - 14	822.130.0	7 - 24	822.229.6	7 - 23
814.350.1	5 - 18	815.036.3	6 - 10	817.226.6	1 - 13	822.006.9	7 - 19	822.031.3	7 - 15	822.130.3	7 - 25	822.229.9	7 - 22
814.350.7	1 - 39	815.036.5	6 - 19	817.226.9	1 - 31	822.007.0	7 - 14	822.031.6	7 - 20	822.130.6	7 - 30	822.230.0	7 - 17
814.411.1	5 - 18	815.036.6	8 - 12	817.235.6	1 - 13	822.007.9	7 - 19	822.031.9	7 - 19	822.130.9	7 - 29	822.230.3	7 - 18
814.411.9	5 - 26	815.042.2	6 - 10	817.235.9	1 - 31	822.008.0	7 - 14	822.106.0	7 - 24	822.131.0	7 - 24	822.230.6	7 - 23
814.412.1	5 - 18	815.042.3	6 - 10	817.240.6	1 - 31	822.008.9	7 - 19	822.106.9	7 - 29	822.131.3	7 - 25	822.230.9	7 - 22
814.412.9	5 - 26	815.042.5	6 - 19	817.240.9	1 - 36	822.009.0	7 - 14	822.107.0	7 - 24	822.131.6	7 - 30	822.231.0	7 - 17
814.416.1	5 - 18	815.042.6	8 - 12	817.250.6	1 - 31	822.009.3	7 - 15	822.107.9	7 - 29	822.131.9	7 - 29	822.231.3	7 - 18
814.416.9	5 - 26	815.048.2	6 - 10	817.250.9	1 - 36	822.009.6	7 - 20	822.108.0	7 - 24	822.206.0	7 - 17	822.231.6	7 - 23

PARTNUMBER / PAGE INFORMATION

P/N	PAGE	P/N	PAGE	P/N	PAGE	P/N	PAGE	P/N	PAGE	P/N	PAGE	P/N	PAGE
822.2319	7-22	822.3319	7-32	823.843.9	7-52	824.010.9	7-20	824.115.0	7-25	824.224.6	7-23	832.032.9	5-36
822.308.0	7-27	823.611.0	7-49	823.844.0	7-48	824.011.0	7-15	824.115.3	7-26	824.224.9	7-22	832.040.9	5-36
822.308.9	7-32	823.611.9	7-53	823.844.9	7-52	824.011.3	7-16	824.115.6	7-31	824.225.0	7-17	832.050.9	5-36
822.309.0	7-27	823.612.0	7-49	823.851.0	7-48	824.011.6	7-21	824.115.9	7-30	824.225.3	7-18	832.063.9	5-36
822.309.3	7-28	823.612.9	7-53	823.851.9	7-52	824.011.9	7-20	824.118.0	7-25	824.225.6	7-23	836.016.0	7-12
822.309.6	7-33	823.613.0	7-49	823.852.0	7-48	824.012.0	7-15	824.118.3	7-26	824.225.9	7-22	836.016.9	7-13
822.309.9	7-32	823.613.9	7-53	823.852.9	7-52	824.012.3	7-16	824.118.6	7-31	824.310.0	7-27	836.020.0	7-12
822.310.0	7-27	823.614.0	7-49	823.853.0	7-48	824.012.6	7-21	824.118.9	7-30	824.310.3	7-28	836.020.9	7-13
822.310.3	7-28	823.614.9	7-53	823.853.9	7-52	824.012.9	7-20	824.119.0	7-25	824.310.6	7-33	836.025.0	7-12
822.310.6	7-33	823.615.0	7-49	823.854.0	7-48	824.013.0	7-15	824.119.3	7-26	824.310.9	7-32	836.025.9	7-13
822.310.9	7-32	823.615.9	7-53	823.855.0	7-48	824.013.3	7-16	824.119.6	7-31	824.311.0	7-27	836.032.0	7-12
822.311.0	7-27	823.618.0	7-49	823.856.0	7-48	824.013.6	7-21	824.119.9	7-30	824.311.3	7-28	836.032.9	7-13
822.311.3	7-28	823.618.9	7-53	823.857.0	7-48	824.013.9	7-20	824.123.0	7-25	824.311.6	7-33	836.040.0	7-12
822.311.6	7-33	823.619.0	7-49	823.858.0	7-48	824.014.0	7-15	824.123.3	7-26	824.311.9	7-32	836.040.9	7-13
822.311.9	7-32	823.619.9	7-53	823.912.0	7-49	824.014.3	7-16	824.123.6	7-31	824.312.0	7-27	836.116.0	7-34
822.312.0	7-27	823.623.0	7-49	823.912.9	7-53	824.014.6	7-21	824.123.9	7-30	824.312.3	7-28	836.116.9	7-36
822.312.3	7-28	823.623.9	7-53	823.913.0	7-49	824.014.9	7-20	824.124.0	7-25	824.312.6	7-33	836.120.0	7-34
822.312.6	7-33	823.624.0	7-49	823.913.9	7-53	824.015.0	7-15	824.124.3	7-26	824.312.9	7-32	836.120.9	7-36
822.312.9	7-32	823.624.9	7-53	823.914.0	7-49	824.015.3	7-16	824.124.6	7-31	824.313.0	7-27	836.125.0	7-34
822.313.0	7-27	823.625.0	7-49	823.914.9	7-53	824.015.6	7-21	824.124.9	7-30	824.313.3	7-28	836.125.9	7-36
822.313.3	7-28	823.625.9	7-53	823.915.0	7-49	824.015.9	7-20	824.125.0	7-25	824.313.6	7-33	836.132.0	7-34
822.313.6	7-33	823.629.0	7-49	823.915.9	7-53	824.018.0	7-15	824.125.3	7-26	824.313.9	7-32	836.132.9	7-36
822.313.9	7-32	823.629.9	7-53	823.918.0	7-49	824.018.3	7-16	824.125.6	7-31	824.314.0	7-27	836.140.0	7-34
822.314.0	7-27	823.630.0	7-49	823.918.9	7-53	824.018.6	7-21	824.125.9	7-30	824.314.3	7-28	836.140.9	7-36
822.314.3	7-28	823.630.9	7-53	823.919.0	7-49	824.018.9	7-20	824.210.0	7-17	824.314.6	7-33	836.150.0	7-34
822.314.6	7-33	823.631.0	7-49	823.919.9	7-53	824.019.0	7-15	824.210.3	7-18	824.314.9	7-32	836.150.9	7-36
822.314.9	7-32	823.631.9	7-53	823.923.0	7-49	824.019.3	7-16	824.210.6	7-23	824.315.0	7-27	836.216.0	7-56
822.315.0	7-27	823.643.0	7-49	823.923.9	7-53	824.019.6	7-21	824.210.9	7-22	824.315.3	7-28	836.216.9	7-57
822.315.3	7-28	823.643.9	7-53	823.924.0	7-49	824.019.9	7-20	824.211.0	7-17	824.315.6	7-33	836.220.0	7-56
822.315.6	7-33	823.644.0	7-49	823.924.9	7-53	824.023.0	7-15	824.211.3	7-18	824.315.9	7-32	836.220.9	7-57
822.315.9	7-32	823.644.9	7-53	823.925.0	7-49	824.023.3	7-16	824.211.6	7-23	824.318.0	7-27	836.225.0	7-56
822.318.0	7-27	823.651.0	7-49	823.925.9	7-53	824.023.6	7-21	824.211.9	7-22	824.318.3	7-28	836.225.9	7-57
822.318.3	7-28	823.651.9	7-53	823.929.0	7-49	824.023.9	7-20	824.212.0	7-17	824.318.6	7-33	836.232.0	7-56
822.318.6	7-33	823.652.0	7-49	823.929.9	7-53	824.024.0	7-15	824.212.3	7-18	824.318.9	7-32	836.232.9	7-57
822.318.9	7-32	823.652.9	7-53	823.930.0	7-49	824.024.3	7-16	824.212.6	7-23	824.319.0	7-27	836.240.0	7-56
822.319.0	7-27	823.653.0	7-49	823.930.9	7-53	824.024.6	7-21	824.212.9	7-22	824.319.3	7-28	836.240.9	7-57
822.319.3	7-28	823.653.9	7-53	823.931.0	7-49	824.024.9	7-20	824.213.0	7-17	824.319.6	7-33	836.250.0	7-56
822.319.6	7-33	823.812.0	7-48	823.931.9	7-53	824.025.0	7-15	824.213.3	7-18	824.319.9	7-32	836.250.9	7-57
822.319.9	7-32	823.812.9	7-52	823.943.0	7-49	824.025.3	7-16	824.213.6	7-23	824.323.0	7-27	837.012.0	7-12
822.323.0	7-27	823.813.0	7-48	823.943.9	7-53	824.025.6	7-21	824.213.9	7-22	824.323.3	7-28	837.012.9	7-13
822.323.3	7-28	823.813.9	7-52	823.944.0	7-49	824.025.9	7-20	824.214.0	7-17	824.323.6	7-33	837.016.0	7-12
822.323.6	7-33	823.814.0	7-48	823.944.9	7-53	824.108.0	7-25	824.214.3	7-18	824.323.9	7-32	837.016.9	7-13
822.323.9	7-32	823.814.9	7-52	823.951.0	7-49	824.110.0	7-25	824.214.6	7-23	824.324.0	7-27	837.020.0	7-12
822.324.0	7-27	823.815.0	7-48	823.951.9	7-53	824.110.3	7-26	824.214.9	7-22	824.324.3	7-28	837.020.9	7-13
822.324.3	7-28	823.815.9	7-52	823.952.0	7-49	824.110.6	7-31	824.215.0	7-17	824.324.6	7-33	837.026.0	7-12
822.324.6	7-33	823.818.0	7-48	823.952.9	7-53	824.110.9	7-30	824.215.3	7-18	824.324.9	7-32	837.026.9	7-13
822.324.9	7-32	823.818.9	7-52	823.953.0	7-49	824.111.0	7-25	824.215.6	7-23	824.325.0	7-27	837.035.0	7-12
822.325.0	7-27	823.819.0	7-48	823.953.9	7-53	824.111.3	7-26	824.215.9	7-22	824.325.3	7-28	837.035.9	7-13
822.325.3	7-28	823.819.9	7-52	823.954.0	7-49	824.111.6	7-31	824.218.0	7-17	824.325.6	7-33	837.116.0	7-35
822.325.6	7-33	823.823.0	7-48	823.954.9	7-53	824.111.9	7-30	824.218.3	7-18	824.325.9	7-32	837.116.9	7-37
822.325.9	7-32	823.823.9	7-52	823.955.0	7-49	824.112.0	7-25	824.218.6	7-23	827.999.1	7-80	837.120.0	7-35
822.329.0	7-27	823.824.0	7-48	823.955.9	7-53	824.112.3	7-26	824.218.9	7-22	828.016.9	8-6	837.120.9	7-37
822.329.3	7-28	823.824.9	7-52	823.956.0	7-49	824.112.6	7-31	824.219.0	7-17	828.020.9	8-6	837.126.0	7-35
822.329.6	7-33	823.825.0	7-48	823.956.9	7-53	824.112.9	7-30	824.219.3	7-18	828.025.9	8-6	837.126.9	7-37
822.329.9	7-32	823.825.9	7-52	823.957.0	7-49	824.113.0	7-25	824.219.6	7-23	828.032.9	8-6	837.135.0	7-35
822.330.0	7-27	823.829.0	7-48	823.957.9	7-53	824.113.3	7-26	824.219.9	7-22	828.040.9	8-6	837.135.9	7-37
822.330.3	7-28	823.829.9	7-52	823.958.0	7-49	824.113.6	7-31	824.223.0	7-17	828.050.9	8-6	837.140.0	7-35
822.330.6	7-33	823.830.0	7-48	823.958.9	7-53	824.113.9	7-30	824.223.3	7-18	828.060.9	8-6	837.140.9	7-37
822.330.9	7-32	823.830.9	7-52	824.008.0	7-15	824.114.0	7-25	824.223.6	7-23	828.063.9	8-6	837.216.0	7-56
822.331.0	7-27	823.831.0	7-48	824.010.0	7-15	824.114.3	7-26	824.223.9	7-22	832.016.9	5-36	837.216.9	7-57
822.331.3	7-28	823.831.9	7-52	824.010.3	7-16	824.114.6	7-31	824.224.0	7-17	832.020.9	5-36	837.220.0	7-56
822.331.6	7-33	823.843.0	7-48	824.010.6	7-21	824.114.9	7-30	824.224.3	7-18	832.025.9	5-36	837.220.9	7-57

PARTNUMBER / PAGE INFORMATION

P/N	PAGE	P/N	PAGE	P/N	PAGE	P/N	PAGE	P/N	PAGE	P/N	PAGE	P/N	PAGE
837226.0	7 - 56	839.815.0	7 - 40	839.943.0	7 - 41	840.056.0	7 - 58	880.011.0	6 - 12	880.320.9	6 - 20	881.016.0	6 - 14
837226.9	7 - 57	839.815.9	7 - 45	839.943.9	7 - 46	840.056.9	7 - 60	880.011.9	6 - 19	880.326.0	6 - 13	881.021.0	6 - 14
837235.0	7 - 56	839.818.0	7 - 40	839.944.0	7 - 41	840.057.0	7 - 58	880.013.0	6 - 12	880.326.9	6 - 20	881.029.0	6 - 14
837235.9	7 - 57	839.818.9	7 - 45	839.944.9	7 - 46	840.057.9	7 - 60	880.013.9	6 - 19	880.335.0	6 - 13	881.036.0	6 - 14
837240.0	7 - 56	839.819.0	7 - 40	839.951.0	7 - 41	840.058.0	7 - 58	880.016.0	6 - 12	880.335.9	6 - 20	881.042.0	6 - 14
837240.9	7 - 57	839.819.9	7 - 45	839.951.9	7 - 46	840.058.9	7 - 60	880.016.9	6 - 19	880.340.0	6 - 13	881.107.0	6 - 14
837513.0	7 - 35	839.823.0	7 - 40	839.952.0	7 - 41	841.012.0	7 - 59	880.021.0	6 - 12	880.340.9	6 - 20	881.109.0	6 - 14
837513.9	7 - 37	839.823.9	7 - 45	839.952.9	7 - 46	841.012.9	7 - 61	880.021.9	6 - 19	880.350.0	6 - 13	881.111.0	6 - 14
837516.0	7 - 35	839.824.0	7 - 40	839.953.0	7 - 41	841.013.0	7 - 59	880.029.0	6 - 12	880.350.9	6 - 20	881.116.0	6 - 14
837516.9	7 - 37	839.824.9	7 - 45	839.953.9	7 - 46	841.013.9	7 - 61	880.029.9	6 - 19	880.363.0	6 - 13	881.121.0	6 - 14
837521.0	7 - 35	839.825.0	7 - 40	839.954.0	7 - 41	841.014.0	7 - 59	880.036.0	6 - 12	880.363.9	6 - 20	881.129.0	6 - 14
837521.9	7 - 37	839.825.9	7 - 45	839.954.9	7 - 46	841.014.9	7 - 61	880.036.9	6 - 19	880.375.0	6 - 13	881.136.0	6 - 14
837529.0	7 - 35	839.829.0	7 - 40	839.955.0	7 - 41	841.015.0	7 - 59	880.042.0	6 - 12	880.375.9	6 - 20	881.148.0	6 - 14
837529.9	7 - 37	839.829.9	7 - 45	839.955.9	7 - 46	841.015.9	7 - 61	880.048.0	6 - 12	880.510.0	7 - 68	881.216.0	6 - 14
837536.0	7 - 35	839.830.0	7 - 40	839.956.0	7 - 41	841.018.0	7 - 59	880.116.0	6 - 12	880.511.0	7 - 68	881.220.0	6 - 14
837536.9	7 - 37	839.830.9	7 - 45	839.956.9	7 - 46	841.018.9	7 - 61	880.116.9	6 - 21	880.512.0	7 - 68	881.225.0	6 - 14
838.220.9	5 - 34	839.831.0	7 - 40	839.957.0	7 - 41	841.019.0	7 - 59	880.116.9	6 - 19	880.513.0	7 - 68	881.232.0	6 - 14
838.226.9	5 - 34	839.831.9	7 - 45	839.957.9	7 - 46	841.019.9	7 - 61	880.120.0	6 - 12	880.516.0	7 - 68	881.240.0	6 - 14
838.520.9	5 - 34	839.843.0	7 - 40	839.958.0	7 - 41	841.023.0	7 - 59	880.120.8	6 - 21	880.520.0	7 - 68	881.250.0	6 - 14
838.526.9	5 - 34	839.843.9	7 - 45	839.958.9	7 - 46	841.023.9	7 - 61	880.120.9	6 - 19	880.521.0	7 - 68	881.263.0	6 - 14
839.611.0	7 - 41	839.844.0	7 - 40	840.010.0	7 - 58	841.024.0	7 - 59	880.125.0	6 - 12	880.525.0	7 - 68	882.009.0	6 - 13
839.611.9	7 - 46	839.844.9	7 - 45	840.010.9	7 - 60	841.024.9	7 - 61	880.125.8	6 - 21	880.527.0	7 - 68	882.011.0	6 - 13
839.612.0	7 - 41	839.851.0	7 - 40	840.011.0	7 - 58	841.025.0	7 - 59	880.125.9	6 - 19	880.529.0	7 - 68	882.012.0	6 - 13
839.612.9	7 - 46	839.851.9	7 - 45	840.011.9	7 - 60	841.025.9	7 - 61	880.132.0	6 - 12	880.532.0	7 - 68	882.013.0	6 - 13
839.613.0	7 - 41	839.852.0	7 - 40	840.012.0	7 - 58	841.029.0	7 - 59	880.132.8	6 - 21	880.535.0	7 - 68	882.016.0	6 - 13
839.613.9	7 - 46	839.852.9	7 - 45	840.012.9	7 - 60	841.029.9	7 - 61	880.132.9	6 - 19	880.536.0	7 - 68	882.017.0	6 - 13
839.614.0	7 - 41	839.853.0	7 - 40	840.013.0	7 - 58	841.030.0	7 - 59	880.140.0	6 - 12	880.542.0	7 - 68	882.018.0	6 - 13
839.614.9	7 - 46	839.853.9	7 - 45	840.013.9	7 - 60	841.030.9	7 - 61	880.140.8	6 - 21	880.548.0	7 - 68	882.021.0	6 - 13
839.615.0	7 - 41	839.854.0	7 - 40	840.014.0	7 - 58	841.031.0	7 - 59	880.140.9	6 - 19	880.550.0	7 - 68	882.029.0	6 - 13
839.615.9	7 - 46	839.854.9	7 - 45	840.014.9	7 - 60	841.031.9	7 - 61	880.150.0	6 - 12	880.610.0	6 - 18	882.036.0	6 - 13
839.618.0	7 - 41	839.855.0	7 - 40	840.015.0	7 - 58	841.043.0	7 - 59	880.150.8	6 - 21	880.610.8	6 - 21	882.042.0	6 - 13
839.618.9	7 - 46	839.855.9	7 - 45	840.015.9	7 - 60	841.043.9	7 - 61	880.150.9	6 - 19	880.612.0	6 - 18	882.048.0	6 - 13
839.619.0	7 - 41	839.856.0	7 - 40	840.018.0	7 - 58	841.044.0	7 - 59	880.163.0	6 - 12	880.612.8	6 - 21	882.111.0	6 - 13
839.619.9	7 - 46	839.856.9	7 - 45	840.018.9	7 - 60	841.044.9	7 - 61	880.163.8	6 - 21	880.613.0	6 - 18	882.116.0	6 - 13
839.623.0	7 - 41	839.857.0	7 - 40	840.019.0	7 - 58	841.051.0	7 - 59	880.163.9	6 - 19	880.613.8	6 - 21	882.121.0	6 - 13
839.623.9	7 - 46	839.857.9	7 - 45	840.019.9	7 - 60	841.051.9	7 - 61	880.175.0	6 - 12	880.620.0	6 - 18	882.129.0	6 - 13
839.624.0	7 - 41	839.858.0	7 - 40	840.023.0	7 - 58	841.052.0	7 - 59	880.190.0	6 - 12	880.620.8	6 - 21	882.136.0	6 - 13
839.624.9	7 - 46	839.858.9	7 - 45	840.023.9	7 - 60	841.052.9	7 - 61	880.216.0	6 - 12	880.627.0	6 - 18	882.148.0	6 - 13
839.625.0	7 - 41	839.912.0	7 - 41	840.024.0	7 - 58	841.053.0	7 - 59	880.216.8	6 - 21	880.627.8	6 - 21	882.212.0	6 - 15
839.625.9	7 - 46	839.912.9	7 - 46	840.024.9	7 - 60	841.053.9	7 - 61	880.216.9	6 - 19	880.635.0	6 - 18	882.216.0	6 - 15
839.629.0	7 - 41	839.913.0	7 - 41	840.025.0	7 - 58	841.054.0	7 - 59	880.220.0	6 - 12	880.635.8	6 - 21	882.220.0	6 - 15
839.629.9	7 - 46	839.913.9	7 - 46	840.025.9	7 - 60	841.054.9	7 - 61	880.220.8	6 - 21	880.650.0	6 - 18	882.225.0	6 - 15
839.630.0	7 - 41	839.914.0	7 - 41	840.029.0	7 - 58	841.055.0	7 - 59	880.220.9	6 - 19	880.650.8	6 - 21	882.232.0	6 - 15
839.630.9	7 - 46	839.914.9	7 - 46	840.029.9	7 - 60	841.055.9	7 - 61	880.226.0	6 - 12	880.716.0	6 - 18	882.240.0	6 - 15
839.631.0	7 - 41	839.915.0	7 - 41	840.030.0	7 - 58	841.056.0	7 - 59	880.226.8	6 - 21	880.716.8	6 - 21	882.250.0	6 - 15
839.631.9	7 - 46	839.915.9	7 - 46	840.030.9	7 - 60	841.056.9	7 - 61	880.226.9	6 - 19	880.720.0	6 - 18	882.309.0	6 - 15
839.643.0	7 - 41	839.918.0	7 - 41	840.031.0	7 - 58	841.057.0	7 - 59	880.235.0	6 - 12	880.720.8	6 - 21	882.311.0	6 - 15
839.643.9	7 - 46	839.918.9	7 - 46	840.031.9	7 - 60	841.057.9	7 - 61	880.235.8	6 - 21	880.726.0	6 - 18	882.313.0	6 - 15
839.644.0	7 - 41	839.919.0	7 - 41	840.043.0	7 - 58	841.058.0	7 - 59	880.235.9	6 - 19	880.726.8	6 - 21	882.316.0	6 - 15
839.644.9	7 - 46	839.919.9	7 - 46	840.043.9	7 - 60	841.058.9	7 - 61	880.240.0	6 - 12	880.735.0	6 - 18	882.321.0	6 - 15
839.651.0	7 - 41	839.923.0	7 - 41	840.044.0	7 - 58	842.016.0	1 - 52	880.240.8	6 - 21	880.735.8	6 - 21	882.326.0	6 - 15
839.651.9	7 - 46	839.923.9	7 - 46	840.044.9	7 - 60	842.017.0	1 - 52	880.240.9	6 - 19	880.740.0	6 - 18	882.329.0	6 - 15
839.652.0	7 - 41	839.924.0	7 - 41	840.051.0	7 - 58	842.020.0	1 - 52	880.250.0	6 - 12	880.740.8	6 - 21	882.330.0	6 - 15
839.652.9	7 - 46	839.924.9	7 - 46	840.051.9	7 - 60	842.020.9	1 - 52	880.250.8	6 - 21	880.750.0	6 - 18	882.336.0	6 - 15
839.653.0	7 - 41	839.925.0	7 - 41	840.052.0	7 - 58	842.032.0	1 - 52	880.250.9	6 - 19	880.750.8	6 - 21	882.340.0	6 - 15
839.653.9	7 - 46	839.925.9	7 - 46	840.052.9	7 - 60	844.012.0	1 - 52	880.263.0	6 - 12	881.007.0	6 - 14	882.342.0	6 - 15
839.812.0	7 - 40	839.929.0	7 - 41	840.053.0	7 - 58	844.016.0	1 - 52	880.263.9	6 - 19	881.008.0	6 - 14	882.348.0	6 - 15
839.812.9	7 - 45	839.929.9	7 - 46	840.053.9	7 - 60	844.018.0	1 - 52	880.275.0	6 - 12	881.009.0	6 - 14	882.410.0	6 - 15
839.813.0	7 - 40	839.930.0	7 - 41	840.054.0	7 - 58	844.020.0	1 - 52	880.275.9	6 - 19	881.011.0	6 - 14	882.411.0	6 - 15
839.813.9	7 - 45	839.930.9	7 - 46	840.054.9	7 - 60	844.020.9	1 - 52	880.316.0	6 - 13	881.012.0	6 - 14	882.412.0	6 - 15
839.814.0	7 - 40	839.931.0	7 - 41	840.055.0	7 - 58	880.007.0	6 - 12	880.316.9	6 - 20	881.013.0	6 - 14	882.413.0	6 - 15
839.814.9	7 - 45	839.931.9	7 - 46	840.055.9	7 - 60	880.009.0	6 - 12	880.320.0	6 - 13	881.015.0	6 - 14	882.416.0	6 - 15

PARTNUMBER / PAGE INFORMATION

P/N	PAGE	P/N	PAGE	P/N	PAGE	P/N	PAGE	P/N	PAGE
882.420.0	6 - 15	885.050.2	6 - 24	7124400.NM	8 - 11	7141169.6	1 - 21	7149409.2	5 - 22
882.435.0	6 - 15	885.216.0	6 - 17	7124500.NM	8 - 11	7141209.2	5 - 30	7149509.2	5 - 22
882.440.0	6 - 15	885.216.1	6 - 17	7124630.NM	8 - 11	7141209.6	1 - 21	7149759.2	5 - 22
882.450.0	6 - 15	885.220.0	6 - 17	7125169.6	1 - 21	7141269.2	5 - 30	7189400.NM	8 - 16
882.516.0	6 - 16	885.220.1	6 - 17	7125169.NM	8 - 18	7141269.6	1 - 21	7189500.NM	8 - 16
882.520.0	6 - 16	885.225.0	6 - 17	7125179.6	1 - 21	7141359.2	5 - 30	7189630.NM	8 - 16
882.522.0	6 - 16	885.225.1	6 - 17	7125179.NM	8 - 18	7141359.6	1 - 21	738712.92	6 - 30
882.524.0	6 - 16	885.232.0	6 - 17	7125209.6	1 - 21	7141409.2	5 - 30	738716.92	6 - 30
882.525.0	6 - 16	885.232.1	6 - 17	7125209.NM	8 - 18	7141509.2	5 - 30	738718.92	6 - 30
882.527.0	6 - 16	885.240.0	6 - 17	7125259.6	1 - 21	7142119.2	5 - 30	738720.92	6 - 30
882.528.0	6 - 16	885.240.1	6 - 17	7125259.NM	8 - 18	7142129.2	5 - 30	738723.92	6 - 30
882.532.0	6 - 16	885.306.0	6 - 24	7125329.6	1 - 21	7142169.2	5 - 30	738726.92	6 - 30
882.536.0	6 - 16	885.310.0	6 - 24	7125329.NM	8 - 18	7142209.2	5 - 30	738730.92	6 - 30
882.538.0	6 - 16	885.312.0	6 - 24	7125409.6	1 - 21	7142269.2	5 - 30	738735.92	6 - 30
882.540.0	6 - 16	885.316.0	6 - 24	7125409.NM	8 - 18	7142359.2	5 - 30	738738.92	6 - 30
882.548.0	6 - 16	885.320.0	6 - 24	7125509.NM	8 - 18	7142409.2	5 - 30	738740.92	6 - 30
882.550.0	6 - 16	885.326.0	6 - 24	7125639.NM	8 - 18	7142509.2	5 - 30	8107117.3	1 - 39
882.552.0	6 - 16	885.335.0	6 - 24	7127122.7	1 - 46	7142759.2	5 - 30	8107157.3	1 - 39
882.560.0	6 - 16	885.340.0	6 - 24	7127132.7	1 - 46	7144119.2	5 - 22	8107167.3	1 - 39
882.563.0	6 - 16	885.350.0	6 - 24	7127142.7	1 - 46	7144129.2	5 - 22	8107217.3	1 - 39
882.612.0	6 - 16	885.363.0	6 - 24	7127152.7	1 - 46	7144169.2	5 - 22	8127157.3	1 - 37
882.616.0	6 - 16	7120160.NM	8 - 11	7129160.NM	8 - 12	7144209.2	5 - 22	8127167.3	1 - 37
882.620.0	6 - 16	7120169.6	1 - 17	7129169.6	1 - 18	7144269.2	5 - 22	8127207.3	1 - 37
882.626.0	6 - 16	7120169.NM	8 - 17	7129169.NM	8 - 17	7144359.2	5 - 22	8127227.3	1 - 37
883.208.0	6 - 9	7120170.NM	8 - 11	7129170.NM	8 - 12	7144409.2	5 - 22	8189160.NM	8 - 16
883.212.0	6 - 9	7120179.6	1 - 17	7129179.6	1 - 18	7144509.2	5 - 22	8189170.NM	8 - 16
883.218.0	6 - 9	7120179.NM	8 - 17	7129179.NM	8 - 17	7144759.2	5 - 22	8189200.NM	8 - 16
883.230.0	6 - 9	7120200.NM	8 - 11	7129200.NM	8 - 12	7145119.2	5 - 31	8189250.NM	8 - 16
883.308.0	6 - 7	7120209.6	1 - 17	7129209.6	1 - 18	7145129.2	5 - 31	8189320.NM	8 - 16
883.308.6	6 - 7	7120209.NM	8 - 17	7129209.NM	8 - 17	7145129.6	1 - 21		
883.308.7	6 - 8	7120250.NM	8 - 11	7129250.NM	8 - 12	7145169.2	5 - 31		
883.310.0	6 - 7	7120259.6	1 - 17	7129259.6	1 - 18	7145169.6	1 - 21		
883.310.6	6 - 7	7120259.NM	8 - 17	7129259.NM	8 - 17	7145209.2	5 - 31		
883.310.7	6 - 8	7120320.NM	8 - 11	7129320.NM	8 - 12	7145209.6	1 - 21		
883.312.0	6 - 7	7120329.6	1 - 17	7129329.6	1 - 18	7145269.2	5 - 31		
883.312.6	6 - 7	7120329.NM	8 - 17	7129329.NM	8 - 17	7145269.6	1 - 21		
883.312.7	6 - 8	7120400.NM	8 - 11	7129400.NM	8 - 12	7145359.2	5 - 31		
883.314.0	6 - 7	7120409.6	1 - 17	7129409.6	1 - 18	7145359.6	1 - 21		
883.314.6	6 - 7	7120409.NM	8 - 17	7129409.NM	8 - 17	7145409.2	5 - 31		
883.314.7	6 - 8	7120500.NM	8 - 11	7129500.NM	8 - 12	7145509.2	5 - 31		
883.316.0	6 - 7	7120509.NM	8 - 17	7129509.NM	8 - 17	7145759.2	5 - 31		
883.316.6	6 - 7	7120630.NM	8 - 11	7129630.NM	8 - 12	714712.92	7 - 31		
883.316.7	6 - 8	7120639.NM	8 - 17	7129639.NM	8 - 17	714716.92	7 - 31		
883.318.0	6 - 7	7121169.6	1 - 20	7140119.2	5 - 22	714718.92	7 - 31		
883.318.6	6 - 7	7121169.NM	8 - 18	7140129.2	5 - 22	714720.92	7 - 31		
883.318.7	6 - 8	7121179.6	1 - 20	7140129.6	1 - 18	714723.92	7 - 31		
883.320.0	6 - 9	7121179.NM	8 - 18	7140169.2	5 - 22	714726.92	7 - 31		
883.334.0	6 - 9	7121209.6	1 - 20	7140169.6	1 - 18	714730.92	7 - 31		
884.008.0	6 - 6	7121209.NM	8 - 18	7140209.2	5 - 22	714735.92	7 - 31		
884.012.0	6 - 6	7121259.6	1 - 20	7140209.6	1 - 18	714738.92	7 - 31		
884.014.0	6 - 6	7121259.NM	8 - 18	7140269.2	5 - 22	714740.92	7 - 31		
884.018.0	6 - 6	7121329.6	1 - 20	7140269.6	1 - 18	7149119.2	5 - 22		
884.030.0	6 - 6	7121329.NM	8 - 18	7140359.2	5 - 22	7149129.2	5 - 22		
885.016.0	6 - 24	7121409.6	1 - 20	7140359.6	1 - 18	7149129.6	1 - 18		
885.016.2	6 - 24	7121409.NM	8 - 18	7140409.2	5 - 22	7149169.2	5 - 22		
885.020.0	6 - 24	7121509.NM	8 - 18	7140509.2	5 - 22	7149169.6	1 - 18		
885.020.2	6 - 24	7121639.NM	8 - 18	7140639.2	5 - 22	7149209.2	5 - 22		
885.026.0	6 - 24	7124160.NM	8 - 11	7140759.2	5 - 22	7149209.6	1 - 18		
885.026.2	6 - 24	7124170.NM	8 - 11	7141119.2	5 - 30	7149269.2	5 - 22		
885.035.0	6 - 24	7124200.NM	8 - 11	7141129.2	5 - 30	7149269.6	1 - 18		
885.035.2	6 - 24	7124250.NM	8 - 11	7141129.6	1 - 21	7149359.2	5 - 22		
885.040.2	6 - 24	7124320.NM	8 - 11	7141169.2	5 - 30	7149359.6	1 - 18		











# Anamet group world wide addresses

The headquarter of Anamet is Anamet Inc. in USA. With factories in USA, Canada and Europe, the Anamet Group is a global organisation. In the field of sales & marketing Anamet Electrical Inc. is responsible for the USA and sells in North America and Oceania, Anamet Canada is responsible for the sales in Canada and Anamet Europe B.V. is responsible for Europe, the Middle East and Asia. The programs of the each group member is in some ways different. For that reason all inquiries, with products from this catalogue, for outside North America and Canada are handled by Anamet Europe B.V.. These inquiries should be addressed to the export department of Anamet Europe B.V. who will take care of the follow up.

The addresses are:

**Manufacturing plant and sales USA:**

Anamet Electrical Inc.  
1000 Broadway Avenue East  
P.O. Box 39  
Mattoon, Illinois,  
United States, 61938-0039

**Tel.:** +01 800 230 3718

**Fax:** +01 217 234 8856

**Website:** [www.anacondasealtite.com](http://www.anacondasealtite.com)



**Manufacturing plant and sales Canada:**

Anamet Canada Inc.  
36 Wolfe St.  
P.O. Box 240  
Frankford, Ontario,  
Canada K0K 2C0

**Tel.:** +01 613 398 1313

**Fax:** +01 613 398 6262

**Website:** [www.anametcanada.com](http://www.anametcanada.com)



**Manufacturing plant and sales Europe and Export:**

Anamet Europe b.v.  
Galwin 5  
1046 AW amsterdam  
P.O. Box 8155  
1005 AD Amsterdam  
The Netherlands

**Tel.:** +31 (0)20 586 3586

**Fax:** +31 (0)20 688 1126

**Website:** [www.anameteurope.com](http://www.anameteurope.com)





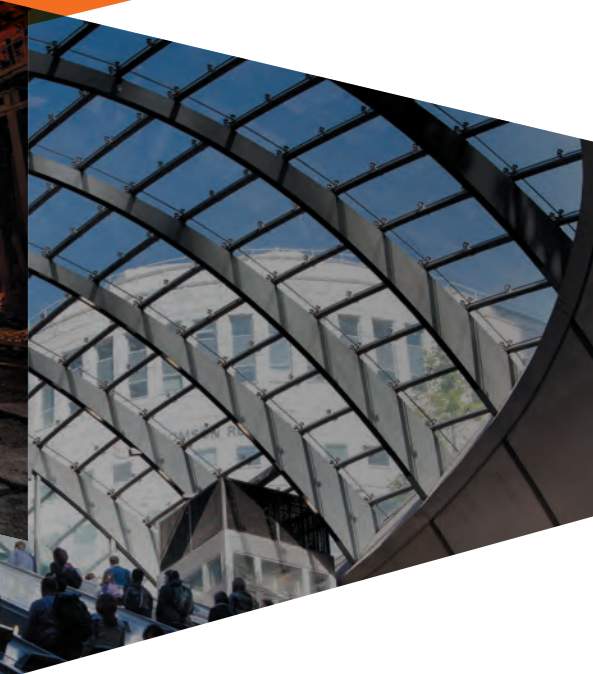

**CONDUIT SYSTEMS  
FOR ELECTRICAL  
WIRES AND CABLES**

CATALOGUE 2019

**TO  
CONNECT  
AND  
PROTECT**



## X-ON Electronics

Largest Supplier of Electrical and Electronic Components

*Click to view similar products for [Spiral Wraps, Sleeves, Tubing & Conduit](#) category:*

*Click to view products by [ANAMET EUROPE](#) manufacturer:*

Other Similar products are found below :

[601203-000](#) [CTA-0053](#) [8426-11](#) [8429-9](#) [8445-7.5](#) [120-104-24](#) [120-113-16B](#) [120-116-1-1-09BE](#) [120-116-1-1-09BF](#) [120-116-1-1-09BP](#) [120-116-1-1-12BE](#) [120-116-1-1-12BP](#) [120-116-1-1-20BP](#) [120-116-1-1-32BE](#) [120-117-40](#) [120-123-06](#) [120-123-10](#) [120-123-14](#) [120-123-16](#) [120-125-12BL](#) [120-125-12R](#) [120-125-16](#) [120-125-16R](#) [120-125-16Y](#) [120-125-20R](#) [120-125-24Y](#) [120-125-28](#) [120-125-28R](#) [120-125-32](#) [120-125-32R](#) [120-125-40](#) [120-125-56](#) [120-126-09](#) [120-126-09BL](#) [120-126-12](#) [120-126-12BL](#) [120-126-14](#) [120-126-16](#) [120-126-16BL](#) [120-126-20](#) [120-126-20BL](#) [120-126-20R](#) [120-126-24](#) [120-126-28](#) [120-126-32](#) [120-126-40BL](#) [120-126-52](#) [120-126-52BL](#) [120-104-12](#) [120-104-20](#)