

Surface Mount Termination 150 Watts, 50Ω

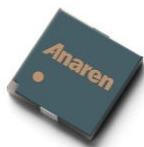

Description

The C150N50Z4 is high performance Aluminum Nitride (AlN) surface mount termination intended as a cost competitive alternative to Beryllium Oxide (BeO). The termination is well suited to all cellular frequency bands such as; AMPS, GSM, DCS, PCS, PHS and UMTS. The high power handling makes the part ideal for terminating high power 90 degree couplers and for use in microstrip circuits. The termination is also RoHS compliant!

Features:

- RoHS Compliant
- 150 Watts
- DC – 4.0 GHz
- AlN Ceramic
- Non-Nichrome Resistive Element
- Low VSWR
- 100% Tested
- Small Size

General Specifications

Resistive Element	Thick film
Substrate	AlN Ceramic
Terminal Finish	Matte Tin over Nickel Barrier
Operating Temperature	-50 to +200°C (see de rating chart)

Tolerance is $\pm 0.010"$, unless otherwise specified. Designed to meet or exceed applicable portions of MIL-E-5400. **All dimensions in inches.**

Electrical Specifications

Resistance Value:	50 Ohms, $\pm 2\%$
Power:	150 Watts
Frequency Range:	DC – 4.0 GHz
Return Loss	>24 dB DC - 2.7 GHz >20 dB DC - 4.0 GHz

Specification based on unit properly installed using suggested mounting instructions and a 50 ohm nominal impedance. **Specifications subject to change.**

Outline Drawing

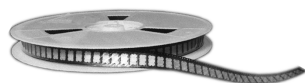
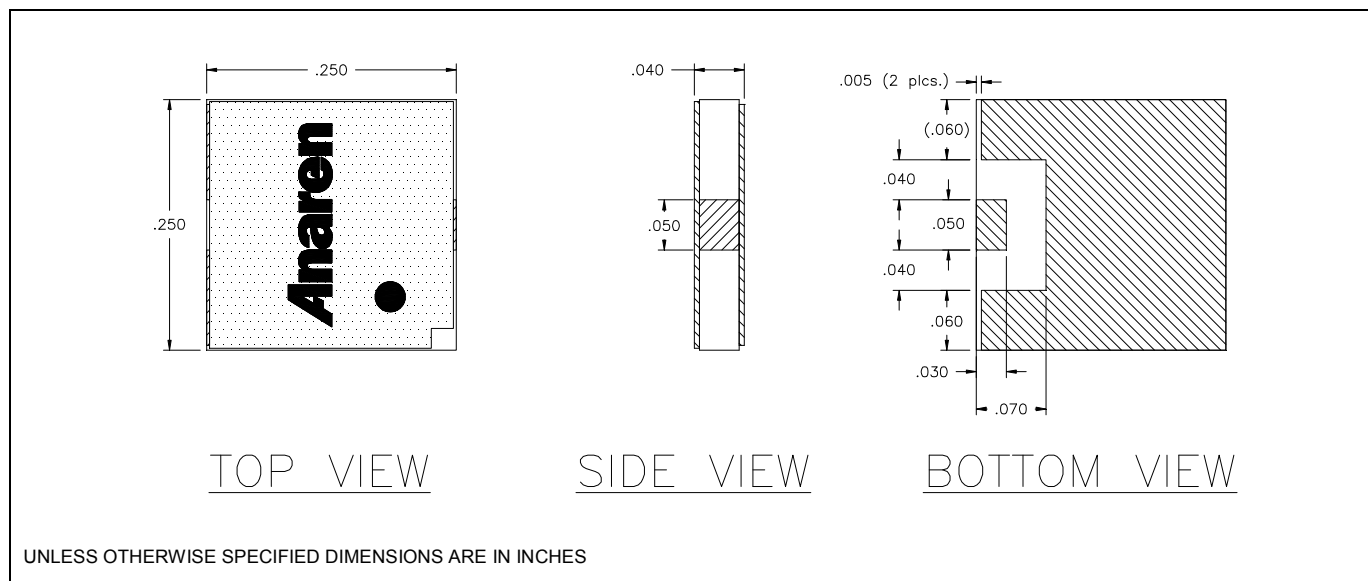

Typical Performance:

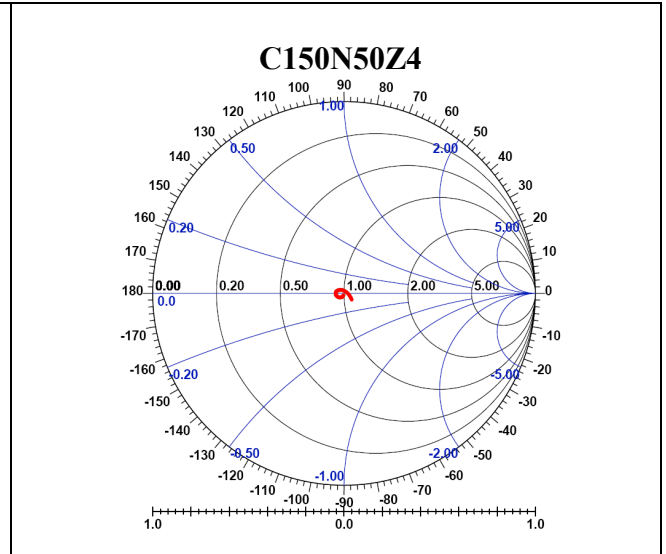
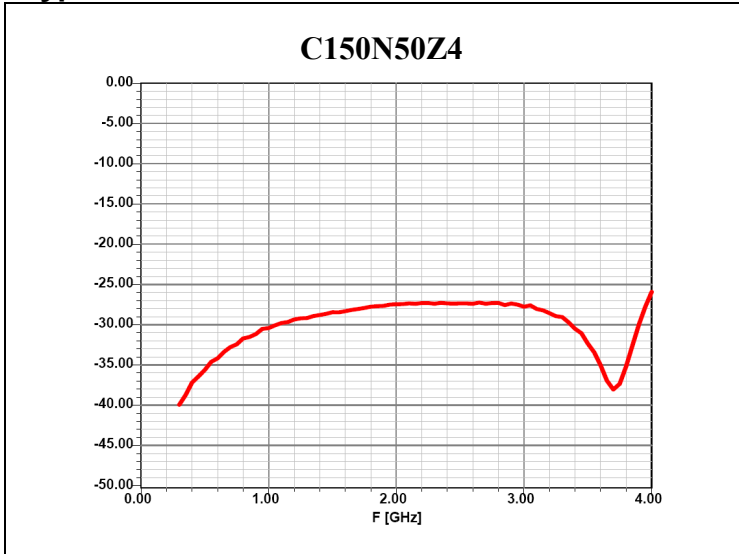

Power De-rating:

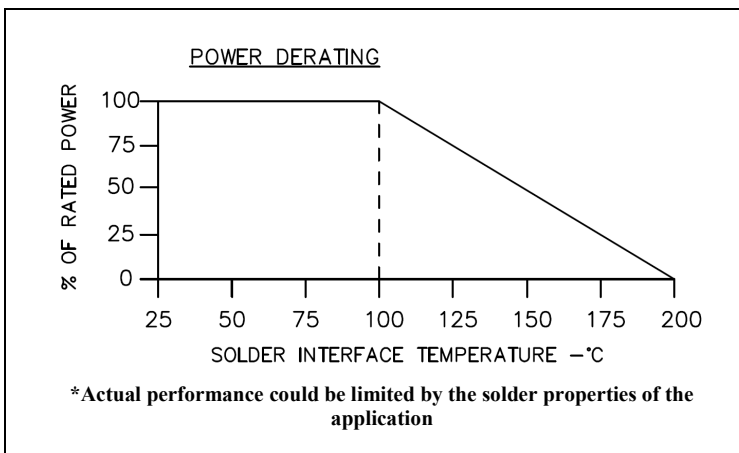

Tape & Reel:

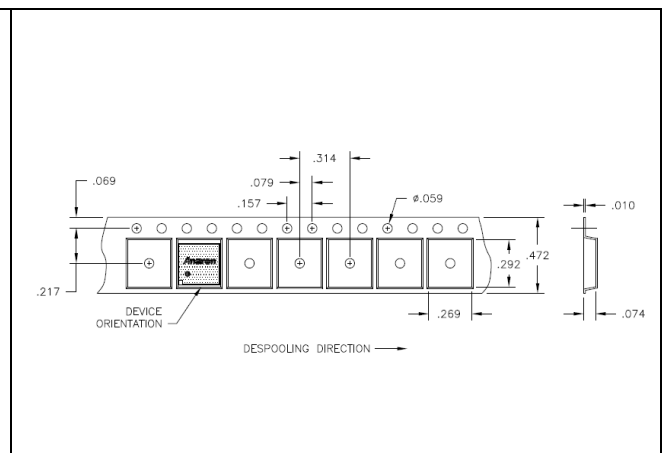

Mounting Footprint and Procedure:

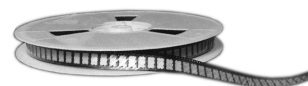
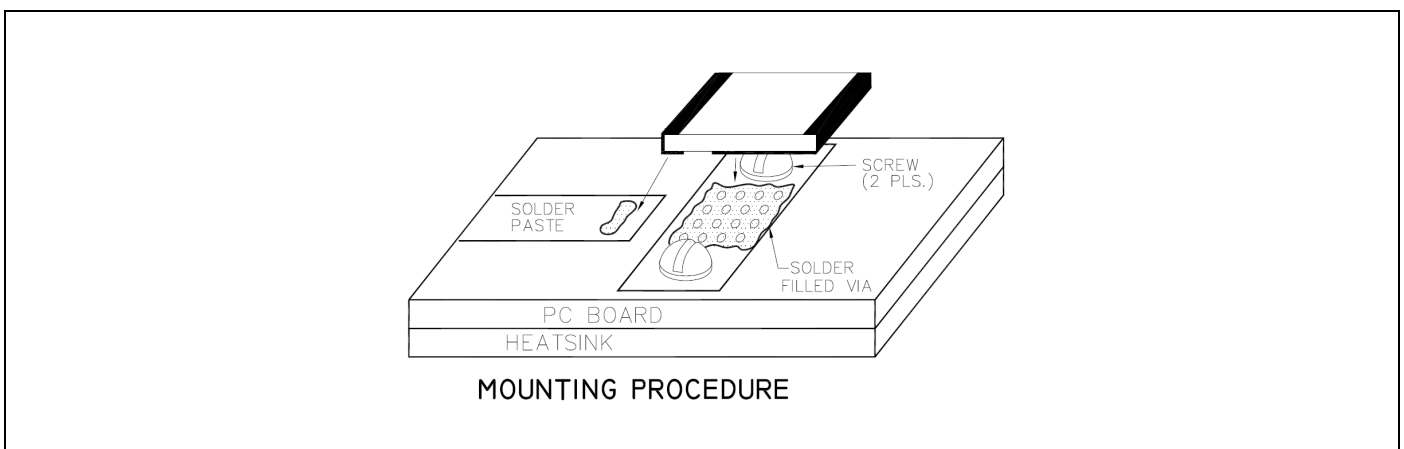

X-ON Electronics

Largest Supplier of Electrical and Electronic Components

Click to view similar products for [High Frequency/RF Resistors](#) category:

Click to view products by [Anaren](#) manufacturer:

Other Similar products are found below :

[800-50T-S](#) [10-100RV-S](#) [E250N50X4](#) [250-100RM-S](#) [250-50RM-S](#) [150-100RL-S](#) [A4B50X1A](#) [10-50TV](#) [G150N50W4B](#) [FC1206E8450FGW0](#)
[R1A06031000G5AR](#) [060120A25X50-2](#) [C45N50Z4](#) [A5B50X1A](#) [100200-4Z50-2](#) [C150N50Z4](#) [30-100R](#) [60-50TP-S](#) [100N50TW](#)
[E200N50X4](#) [250375-4Z50-2](#) [60-50TPR](#) [MIC1000AFLMGNHWS](#) [FT10301N0050J](#) [CS12010T0100GTR](#) [C8A50Z4B](#) [CW12010T0100GTR](#)
[FR10515N0050JBK](#) [FR10515N0100JBK](#) [FR10800N0100JBK](#) [FT10517N0050J01](#) [FT10517N0050JBK](#) [FT10800N0050J02](#)
[LT11020T0050JBK](#) [LT12010T0050JBK](#) [250375-4X50-2](#) [30-100R-S](#) [400-50T](#) [40-50TPP](#) [60-50TP](#) [C10A50Z4](#) [C16A50Z4](#) [C1A50Z4](#)
[C50A50Z4](#) [G250N50W4](#) [G450N50W4](#) [J100N50X4B](#) [K100N50X4B](#) [R2B130850R0J4J0](#) [R3A100550R0J5G0](#)