

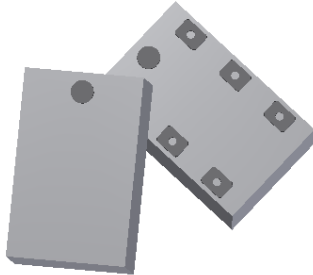

### Ultra Low Profile 0805 5 dB Directional Coupler



#### Description

The DC0710J5005AHF is a low cost, low profile sub-miniature high performance 5 dB directional coupler in an easy to use RoHS compliant, Halogen Free surface mount package. It is designed for 700 – 1000MHz applications including: WCDMA, CDMA, LTE, and GSM800 / 900 applications. The DC0710J5005AHF is ideal for power detection, signal injection and other applications where low insertion loss signal monitoring is required. The DC0710J5005AHF is available on tape and reel for pick and place high volume manufacturing. All of the Xinger components are constructed from ceramic filled PTFE composites which possess excellent electrical and mechanical stability. All parts have been subjected to rigorous qualification testing and units are 100% RF tested.

#### Detailed Electrical Specifications: Specifications subject to change without notice.

| Features:                               | ROOM (25°C)     |                    |           |     |                     |     |                  |     |                  |     |                     |     |                            |      |                              |      |
|---|-----------------|--------------------|-----------|-----|---------------------|-----|------------------|-----|------------------|-----|---------------------|-----|----------------------------|------|------------------------------|------|
|   | Frequency (MHz) | Mean Coupling (dB) |           |     | Insertion loss (dB) |     | Return Loss (dB) |     | Directivity (dB) |     | Phase Balance (deg) |     | Frequency Sensitivity (dB) |      | Power Handling (watts) @85°C |      |
|   |                 | Min                | Typ.      | Max | Typ.                | Max | Typ.             | Min | Typ.             | Min | Typ.                | Max | Typ.                       | Max  | Max                          |      |
| • 700 – 1000 MHz                        | 700 - 1000      | 4.5                | 5.0       | 5.5 | 0.4                 | 0.6 | 21               | 18  | 23               | 19  | 1.4                 | 3   | 0.20                       | 0.30 | 2                            |      |
| • Mean Coupling 5dB                     |                 | 869 - 894          | 4.5       | 5.0 | 5.5                 | 0.4 | 0.5              | 24  | 20               | 29  | 22                  | 1.0 | 3                          | 0.01 | 0.10                         | 2    |
| • Ultra Low Insertion Loss              |                 |                    | 925 - 960 | 4.5 | 5.0                 | 5.5 | 0.4              | 0.6 | 22               | 19  | 25                  | 20  | 1.2                        | 3    | 0.02                         | 0.10 |
| • WCDMA, CDMA, GSM                      |                 |                    |           |     |                     |     |                  |     |                  |     |                     |     |                            |      |                              |      |
| • LTE Bands: 5,6,8,12,13,14,17,18,19,20 |                 |                    |           |     |                     |     |                  |     |                  |     |                     |     |                            |      |                              |      |
| • Surface Mountable                     |                 |                    |           |     |                     |     |                  |     |                  |     |                     |     |                            |      |                              |      |
| • Tape & Reel                           |                 |                    |           |     |                     |     |                  |     |                  |     |                     |     |                            |      |                              |      |
| • RoHS Compliant                        |                 |                    |           |     |                     |     |                  |     |                  |     |                     |     |                            |      |                              |      |
| • Halogen Free                          |                 |                    |           |     |                     |     |                  |     |                  |     |                     |     |                            |      |                              |      |
| • 100% RF Tested                        |                 |                    |           |     |                     |     |                  |     |                  |     |                     |     |                            |      |                              |      |
| • -55°C to 140°C                        |                 |                    |           |     |                     |     |                  |     |                  |     |                     |     |                            |      |                              |      |

\*\*Specification based on performance of unit properly installed on microstrip printed circuit boards with 50 Ω nominal impedance.

#### Outline Drawing

**Top View (Nearside)**

**Bottom View (Farside)**

| Pin | Configuration-1 | Configuration-2 | Configuration-3 | Configuration-4 |
|-----|-----------------|-----------------|-----------------|-----------------|
| 1   | Input           | Isolated        | Direct          | Coupled         |
| 2   | GND             | GND             | GND             | GND             |
| 3   | Isolated        | Input           | Coupled         | Direct          |
| 4   | Direct          | Coupled         | Input           | Isolated        |
| 5   | GND             | GND             | GND             | GND             |
| 6   | Coupled         | Direct          | Isolated        | Input           |

Mechanical Outline  
 -Dimensions are in Millimeters  
 -Tolerances are Non-Cumulative

## Typical Performance: 600 MHz to 1100 MHz (Configuration 1)

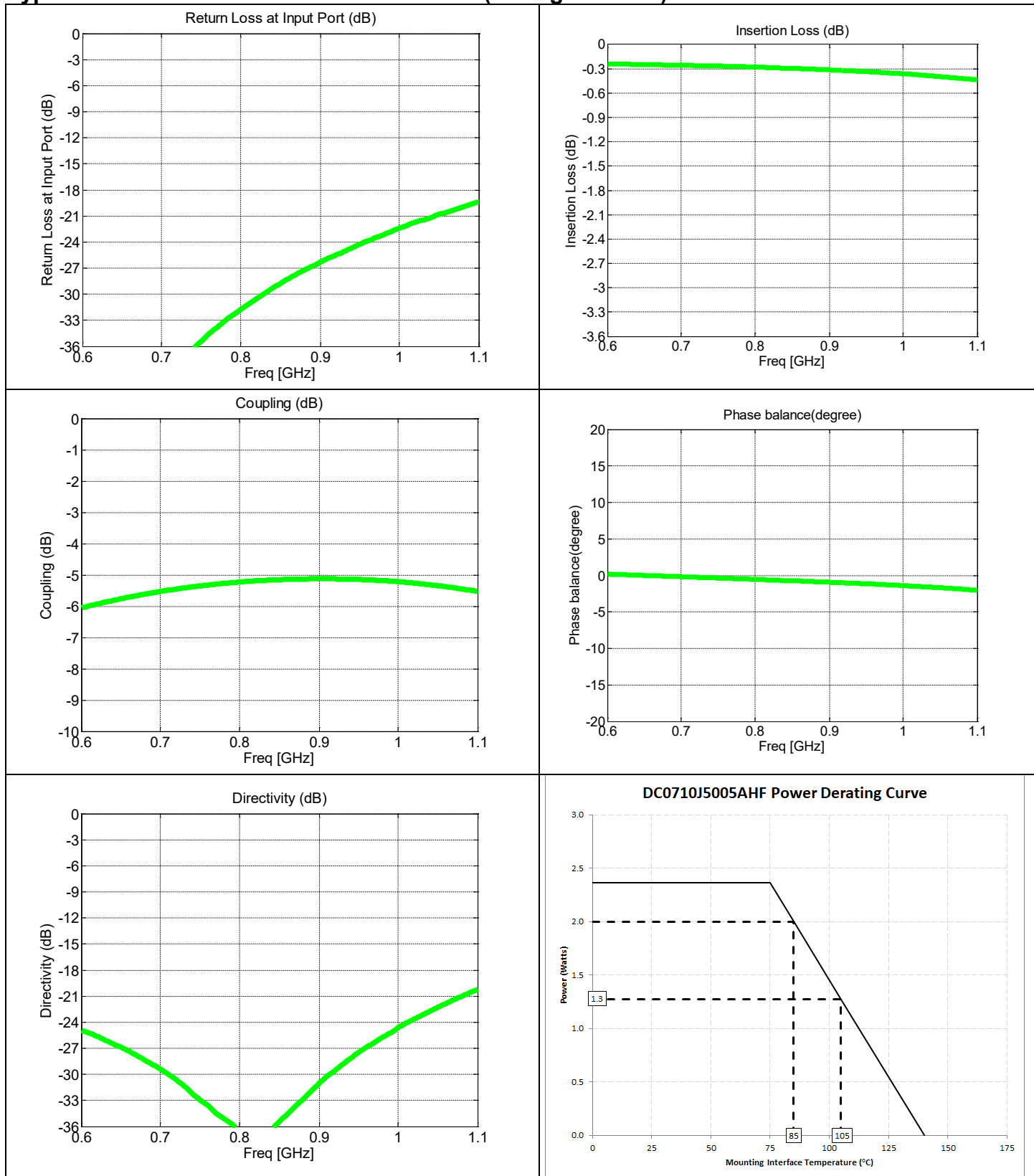

### Wideband Performance: 10MHz to 8010MHz (Configuration 1)

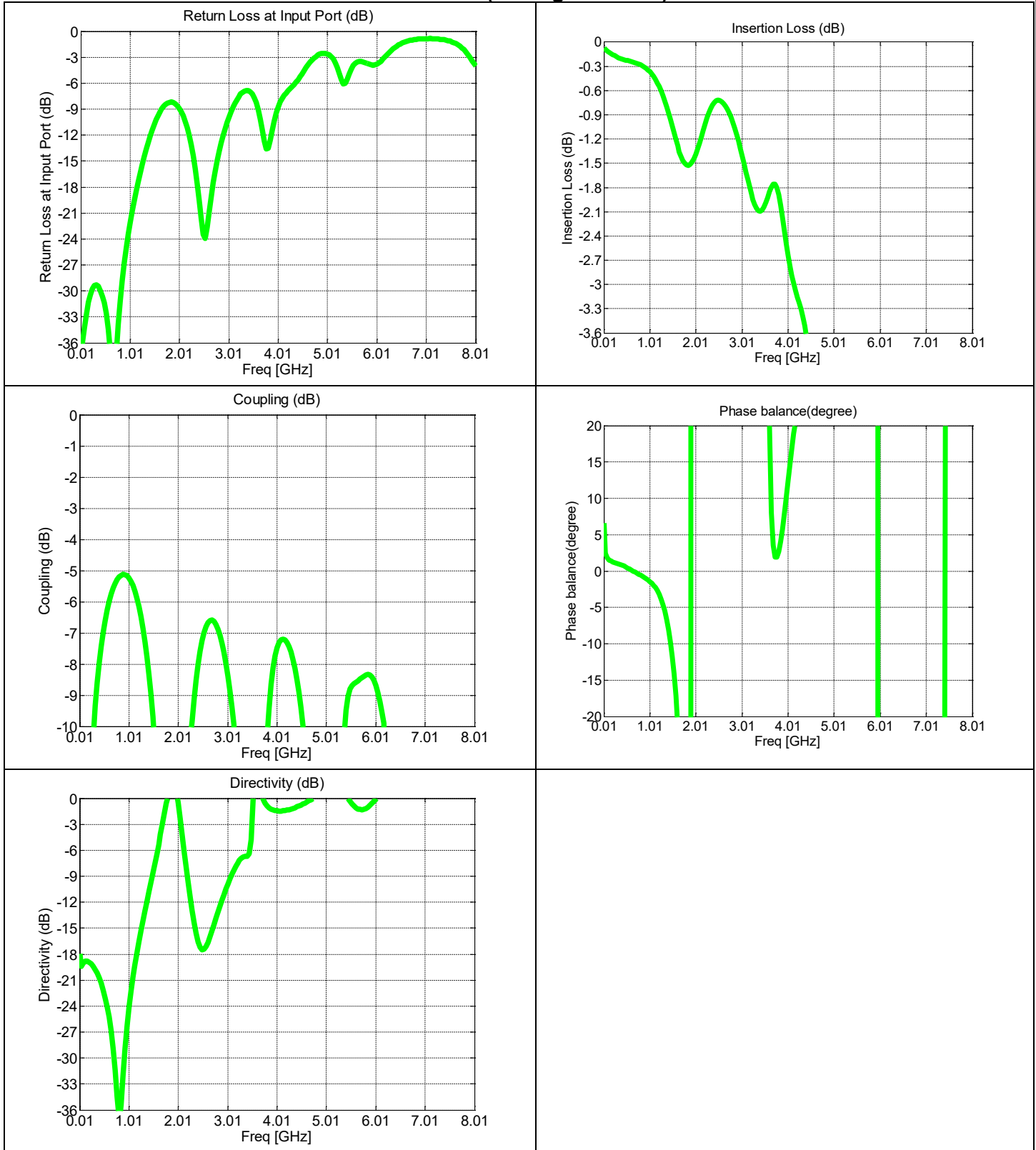

**Definition of Measured Specifications**

| Parameter             | Definition  | <b>Mathematical Representation</b><br><i>i, j, k, m</i> is denoted as the port index of input, isolated, direct and coupled port for specific pin configuration shown in the table above |
|-----------------------|---|--|
| Return Loss           | The impedance match of the coupler to a 50Ω system. Return Loss is an alternate means to express VSWR.  | $20 \log_{10} ( S_{ii} )$  |
| Directivity           | The power at the isolated port divided by the power at the coupled port   | $20 \log_{10} \frac{ S_{ji} }{ S_{mi} }$   |
| Insertion Loss        | The input power divided by the sum of the power at the two output ports.  | $10 \log_{10} ( S_{mi} ^2 +  S_{ki} ^2)$   |
| Mean Coupling         | At a given frequency ( $\omega_n$ ), coupling is the input power divided by the power at the coupled port. Mean coupling is the average value of the coupling values in the band. N is the number of frequencies in the band. | $\text{Coupling (dB)} = 20 \log_{10}  S_{mi} $ $\text{Mean Coupling (dB)} = \frac{\sum_{m=1}^N 20 \log_{10}  S_{mi} }{N}$  |
| Phase Balance         | The difference in phase angle between the two output ports.   | $\angle S_{ki} - \angle S_{mi} + 90^\circ$   |
| Frequency sensitivity | The decibel difference between the maximum in band coupling value and the minimum in band coupling value.   | $(\text{Max Coupling (dB)} - \text{Min Coupling})/2$   |

### Mounting Configuration:

In order for Xinger surface mount components to work optimally, the proper impedance transmission lines must be used to connect to the RF ports. If this condition is not satisfied, insertion loss, Isolation and VSWR may not meet published specifications.

All of the Xinger components are constructed from organic PTFE based composites which possess excellent electrical and mechanical stability. Xinger components are compliant to a variety of ROHS and Green standards and ready for Pb-free soldering processes. Pads are Gold plated with a Nickel barrier.

An example of the PCB footprint used in the testing of these parts is shown below. In specific designs, the transmission line widths need to be adjusted to the unique dielectric coefficients and thicknesses as well as varying pick and place equipment tolerances.

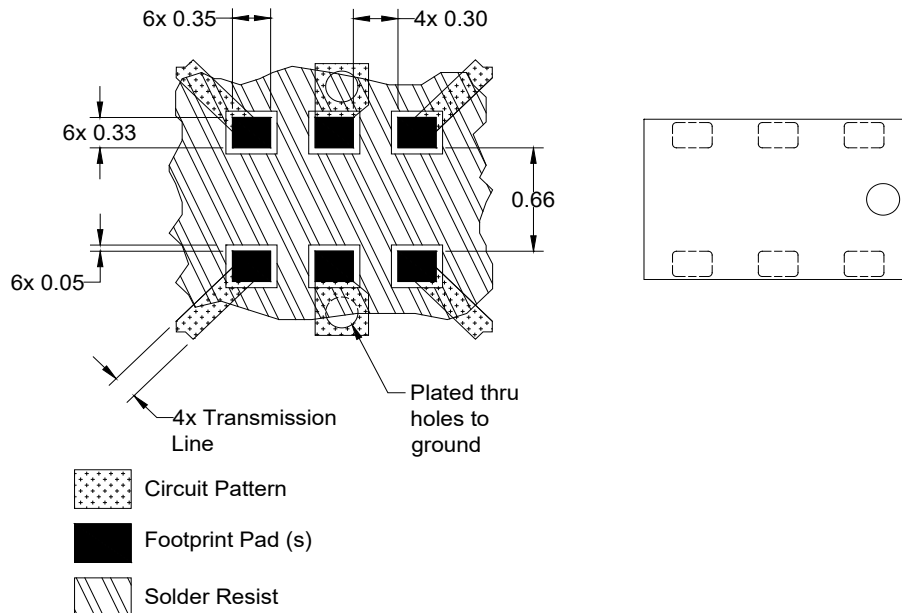

Dimensions are in Millimeters  
Mounting Footprint

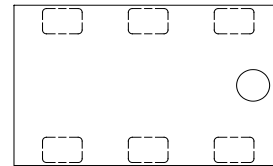

## Packaging and Ordering Information

Parts are available in reel and are packaged per EIA 481-D. Parts are oriented in tape and reel as shown below. Minimum order quantities are 4000 per reel.

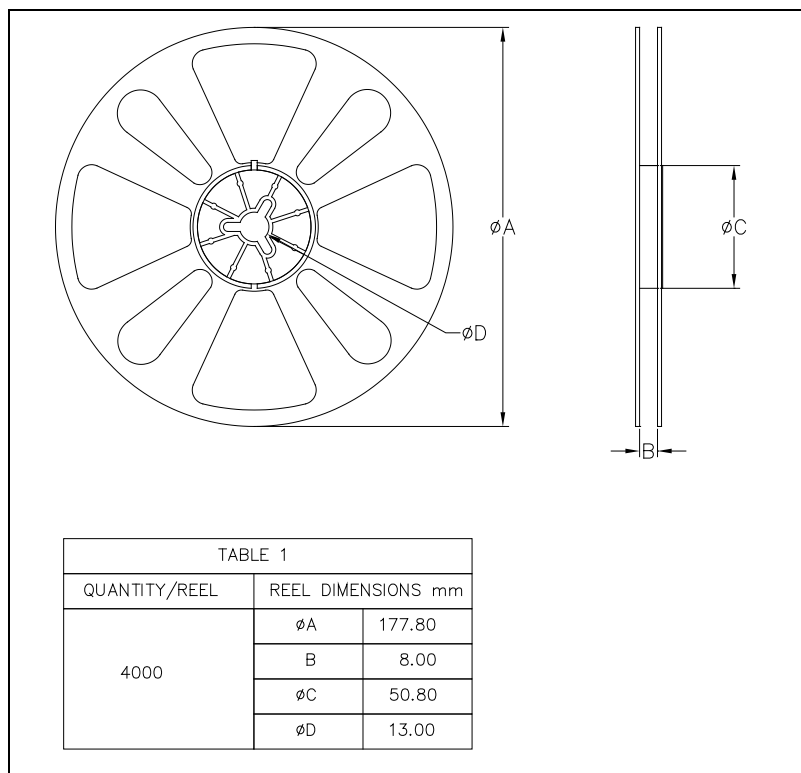
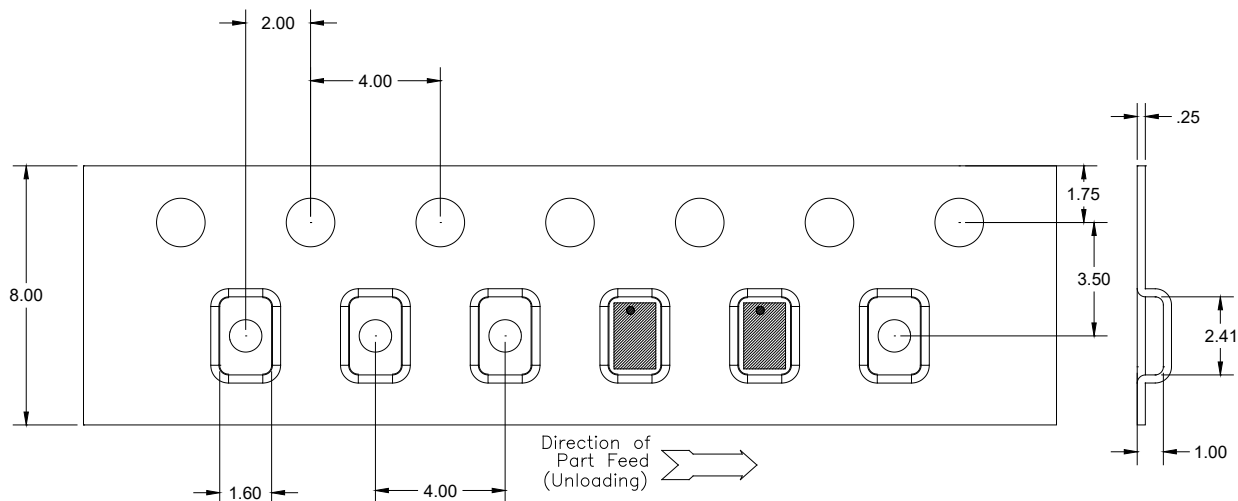

## X-ON Electronics

Largest Supplier of Electrical and Electronic Components

*Click to view similar products for [Signal Conditioning](#) category:*

*Click to view products by [Anaren](#) manufacturer:*

Other Similar products are found below :

[MAPDCC0001](#) [MAPDCC0004](#) [PD0409J5050S2HF](#) [880157](#) [HHS-109-PIN](#) [DC1417J5005AHF](#) [AFS14A30-2185.00-T3](#) [AFS14A35-1591.50-T3](#) [DS-323-PIN](#) [B39321R801H210](#) [1A0220-3](#) [JP510S](#) [LFB212G45SG8C341](#) [LFB322G45SN1A504](#) [LFL182G45TC3B746](#) [SF2159E](#) [30057](#)  
[FM-104-PIN](#) [CER0813B](#) [MAPDCC0005](#) [3A325](#) [40287](#) [41180](#) [ATB3225-75032NCT](#) [BD0810N50100AHF](#) [BD2425J50200AHF](#)  
[C5060J5003AHF](#) [JHS-115-PIN](#) [JP503AS](#) [DC0710J5005AHF](#) [DC2327J5005AHF](#) [DC3338J5005AHF](#) [43020](#) [LFB2H2G60BB1C106](#)  
[LFL15869MTC1B787](#) [X3C19F1-20S](#) [XC3500P-20S](#) [10013-20](#) [SF2194E](#) [CDBLB455KCAX39-B0](#) [TGL2208-SM, EVAL](#) [RF1353C](#)  
[PD0922J5050D2HF](#) [1E1305-3](#) [1G1304-30](#) [B0922J7575AHF](#) [2020-6622-20](#) [TP-102-PIN](#) [TP-103-PIN](#) [BD1222J50200AHF](#)