

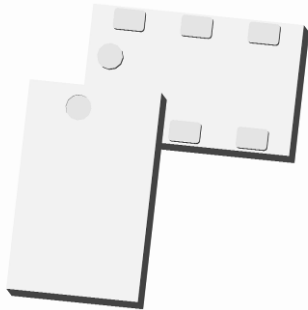

Ultra Low Profile 0805 5 dB Directional Coupler



Description

The DC3338J5005AHF is a low cost, low profile sub-miniature high performance 5 dB directional coupler in an easy to use RoHS compliant, Halogen Free surface mount package. It is designed for 3300 – 3800MHz applications including: LTE, WiMax and WiBro applications. The DC3338J5005AHF is ideal for power detection, signal injection and other applications where low insertion loss signal monitoring is required. The DC3338J5005AHF is available on tape and reel for pick and place high volume manufacturing. All of the Xinger components are constructed from ceramic filled PTFE composites which possess excellent electrical and mechanical stability. All parts have been subjected to rigorous qualification testing and units are 100% RF tested.

Detailed Electrical Specifications: Specifications subject to change without notice.

Features:	ROOM (25°C)														
	Frequency (MHz)	Mean Coupling (dB)			Insertion loss (dB)		Return Loss (dB)		Directivity (dB)		Phase Balance (deg)		Frequency Sensitivity (dB)		Power Handling @85°C (watts)
		Min	Typ.	Max	Typ.	Max	Typ.	Min	Typ.	Min	Typ.	Max	Typ.	Max	Max
• 3300 – 3800 MHz	3300 - 3800	4.5	5.2	5.5	0.30	0.50	20.9	16.5	21.4	17	1.3	4.0	0.04	0.2	2
• Mean Coupling 5dB		4.5	5.2	5.5	0.30	0.50	21.3	16.5	21.9	18	1.1	4.0	0.01	0.1	2
• Ultra Low Insertion Loss		4.5	5.2	5.5	0.30	0.50	22.1	16.5	22.9	18	1.3	4.0	0.03	0.1	2
• WiMax, WiBro	3400 - 3600														
• LTE Bands: 42,43	3600 - 3800														
• Surface Mountable															
• Tape & Reel															
• RoHS Compliant															
• Halogen Free															
• 100% RF Tested															
• -55°C to 140°C															

**Specification based on performance of unit properly installed on microstrip printed circuit boards with 50 Ω nominal impedance.

Outline Drawing

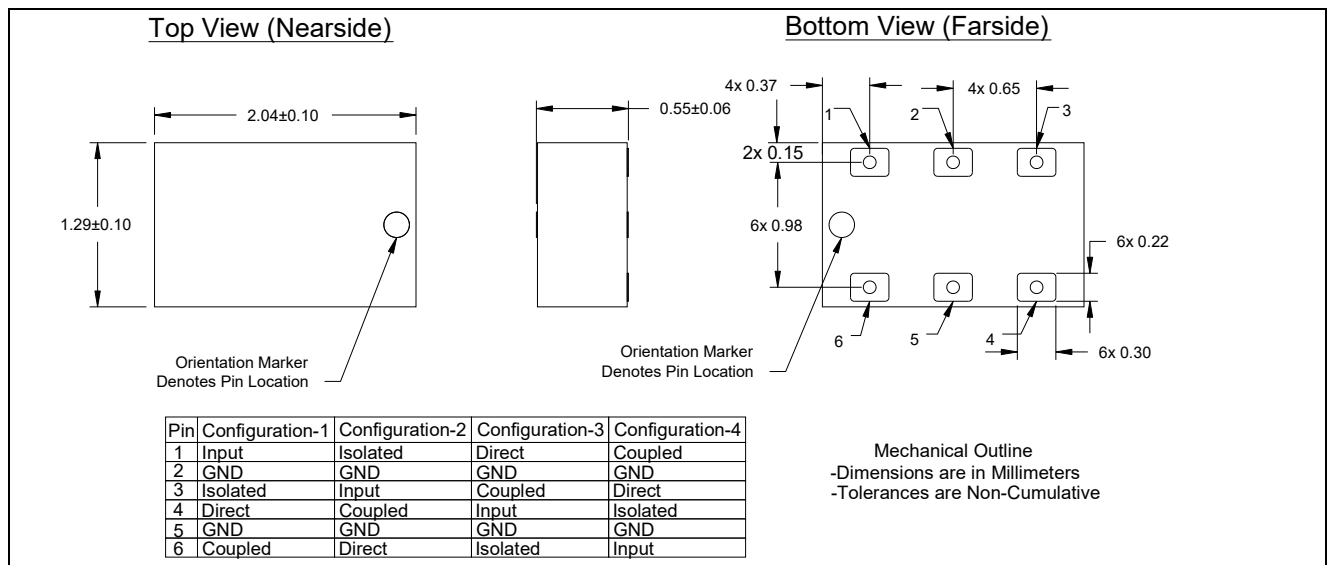

Typical Performance: 3200 MHz to 3900 MHz (Configuration 1)

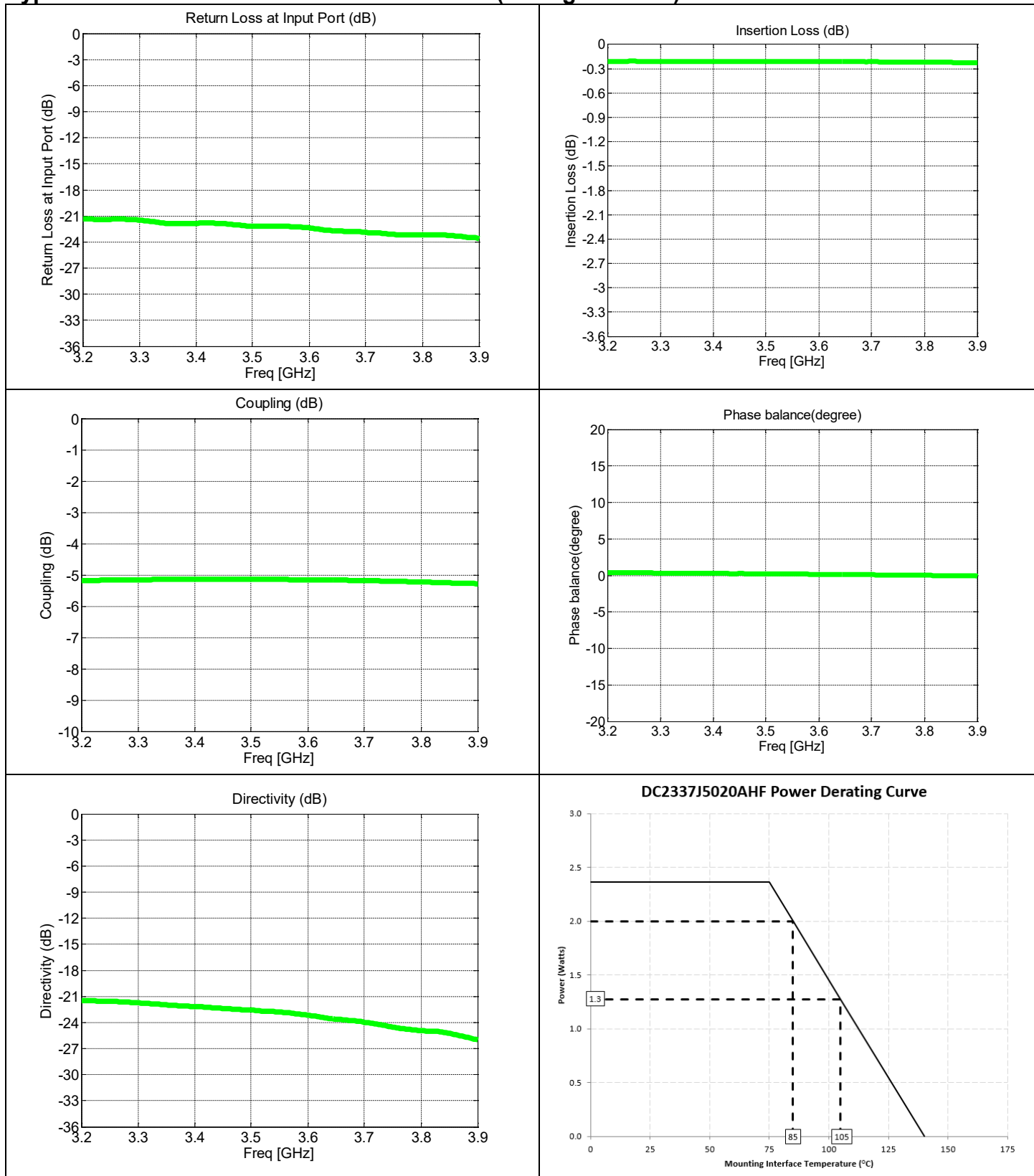

Wideband Performance: 0.01 to 8.01GHz (Configuration 1)

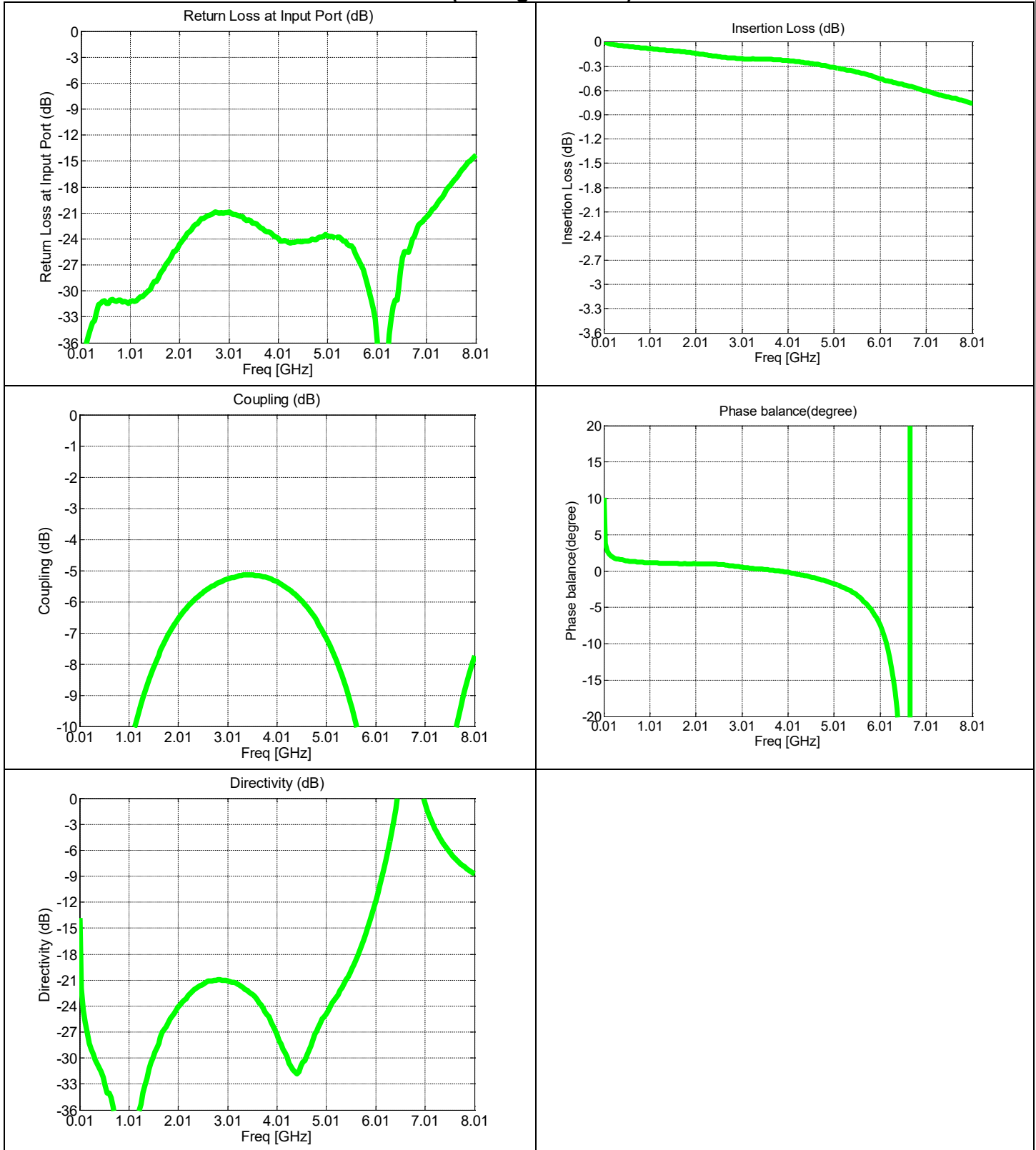

Definition of Measured Specifications

Parameter	Definition	Mathematical Representation <i>i, j, k, m</i> is denoted as the port index of input, isolated, direct and coupled port for specific pin configuration shown in the table above
Return Loss	The impedance match of the coupler to a 50Ω system. Return Loss is an alternate means to express VSWR.	$20 \log_{10}(S_{ii})$
Directivity	The power at the isolated port divided by the power at the coupled port	$20 \log_{10} \frac{ S_{ji} }{ S_{mi} }$
Insertion Loss	The input power divided by the sum of the power at the two output ports.	$10 \log_{10} (S_{mi} ^2 + S_{ki} ^2)$
Mean Coupling	At a given frequency (ω_n), coupling is the input power divided by the power at the coupled port. Mean coupling is the average value of the coupling values in the band. N is the number of frequencies in the band.	$\text{Coupling (dB)} = 20 \log_{10} S_{mi} $ $\text{Mean Coupling (dB)} = \frac{\sum_{m=1}^N 20 \log_{10} S_{mi} }{N}$
Phase Balance	The difference in phase angle between the two output ports.	$\angle S_{ki} - \angle S_{mi} + 90^\circ$
Frequency sensitivity	The decibel difference between the maximum in band coupling value and the minimum in band coupling value.	$(\text{Max Coupling (dB)} - \text{Min Coupling (dB)})/2$

*100% RF test is performed per spec definition for pin configuration 1 and port 1 (input port) is connected to pin1, port 2 (isolated port) is connected to pin 3, port 3 (direct port) is connected to pin 4 and port 4 (isolated) is connected to pin 6.

Mounting Configuration:

In order for Xinger surface mount components to work optimally, the proper impedance transmission lines must be used to connect to the RF ports. If this condition is not satisfied, insertion loss, Isolation and VSWR may not meet published specifications.

All of the Xinger components are constructed from organic PTFE based composites which possess excellent electrical and mechanical stability. Xinger components are compliant to a variety of ROHS and Green standards and ready for Pb-free soldering processes. Pads are Gold plated with a Nickel barrier.

An example of the PCB footprint used in the testing of these parts is shown below. In specific designs, the transmission line widths need to be adjusted to the unique dielectric coefficients and thicknesses as well as varying pick and place equipment tolerances.

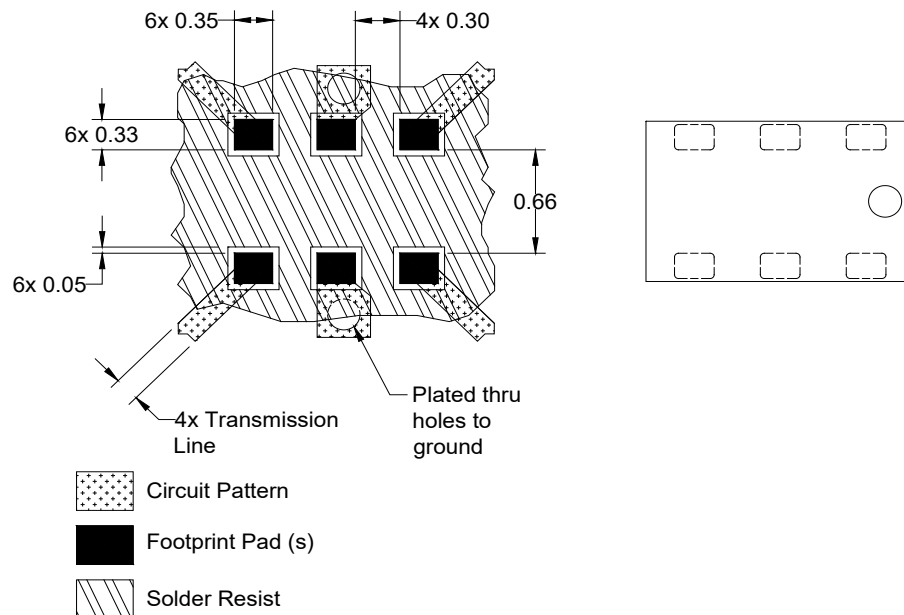

Dimensions are in Millimeters
Mounting Footprint

Packaging and Ordering Information

Parts are available in reel and are packaged per EIA 481-D. Parts are oriented in tape and reel as shown below. Minimum order quantities are 4000 per reel.

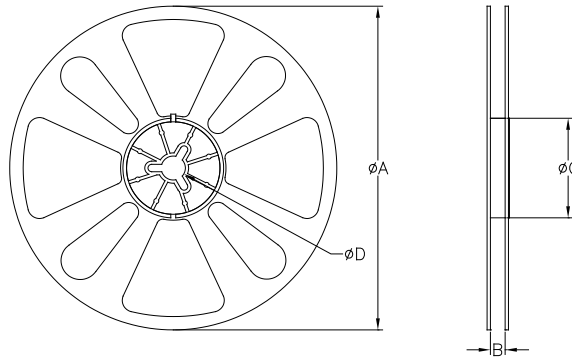
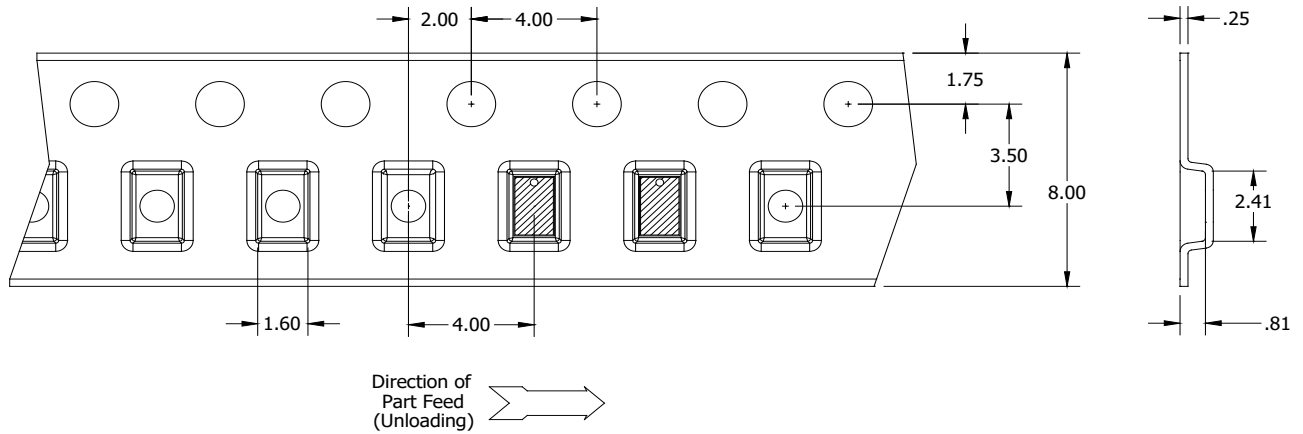

TABLE 1		
QUANTITY/REEL	REEL DIMENSIONS mm	
4000	ϕA	177.80
	B	8.00
	ϕC	50.80
	ϕD	13.00

X-ON Electronics

Largest Supplier of Electrical and Electronic Components

Click to view similar products for [Signal Conditioning](#) category:

Click to view products by [Anaren](#) manufacturer:

Other Similar products are found below :

[MAPDCC0001](#) [MAPDCC0004](#) [PD0409J5050S2HF](#) [880157](#) [HHS-109-PIN](#) [DC1417J5005AHF](#) [AFS14A30-2185.00-T3](#) [AFS14A35-1591.50-T3](#) [DS-323-PIN](#) [B39321R801H210](#) [1A0220-3](#) [JP510S](#) [LFB212G45SG8C341](#) [LFB322G45SN1A504](#) [LFL182G45TC3B746](#) [SF2159E](#) [30057](#) [FM-104-PIN](#) [CER0813B](#) [MAPDCC0005](#) [3A325](#) [40287](#) [41180](#) [ATB3225-75032NCT](#) [BD0810N50100AHF](#) [BD2425J50200AHF](#) [C5060J5003AHF](#) [JHS-115-PIN](#) [JP503AS](#) [DC0710J5005AHF](#) [DC2327J5005AHF](#) [DC3338J5005AHF](#) [43020](#) [LFB2H2G60BB1C106](#) [LFL15869MTC1B787](#) [X3C19F1-20S](#) [XC3500P-20S](#) [10013-20](#) [SF2194E](#) [CDBLB455KCAX39-B0](#) [TGL2208-SM, EVAL](#) [RF1353C](#) [PD0922J5050D2HF](#) [1E1305-3](#) [1G1304-30](#) [B0922J7575AHF](#) [2020-6622-20](#) [TP-102-PIN](#) [TP-103-PIN](#) [BD1222J50200AHF](#)