

LCA NUMBER	MODEL NUMBER
61004-G001	XC0600B-03P

REVISIONS (Δ DENOTES CHANGE)		
REV	DATE	UPDATED BY
D	08/Mar/07	D.A.N.
E	08MAY01	D.ROSE
F	090420	DNORA
G	090420	C.PERRIGO
H	17-08-16	M.GRABO

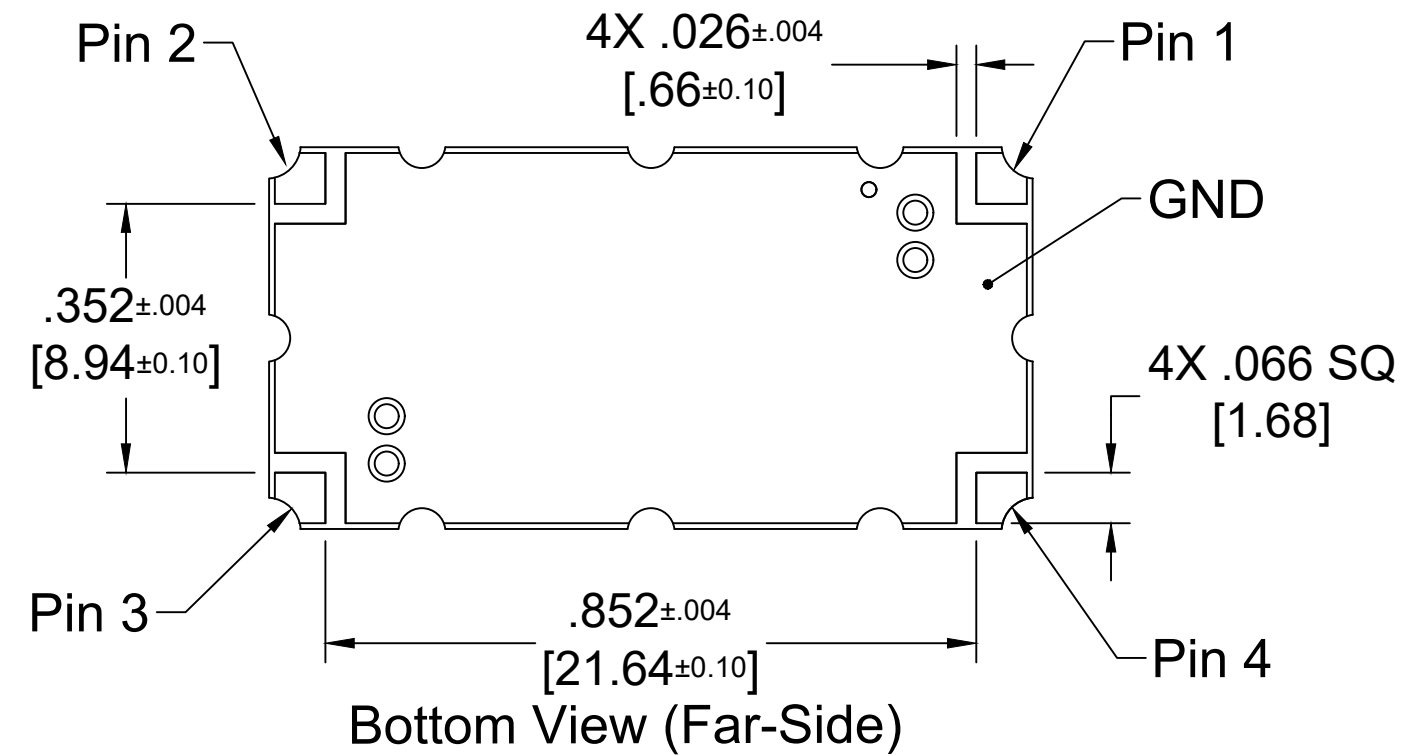
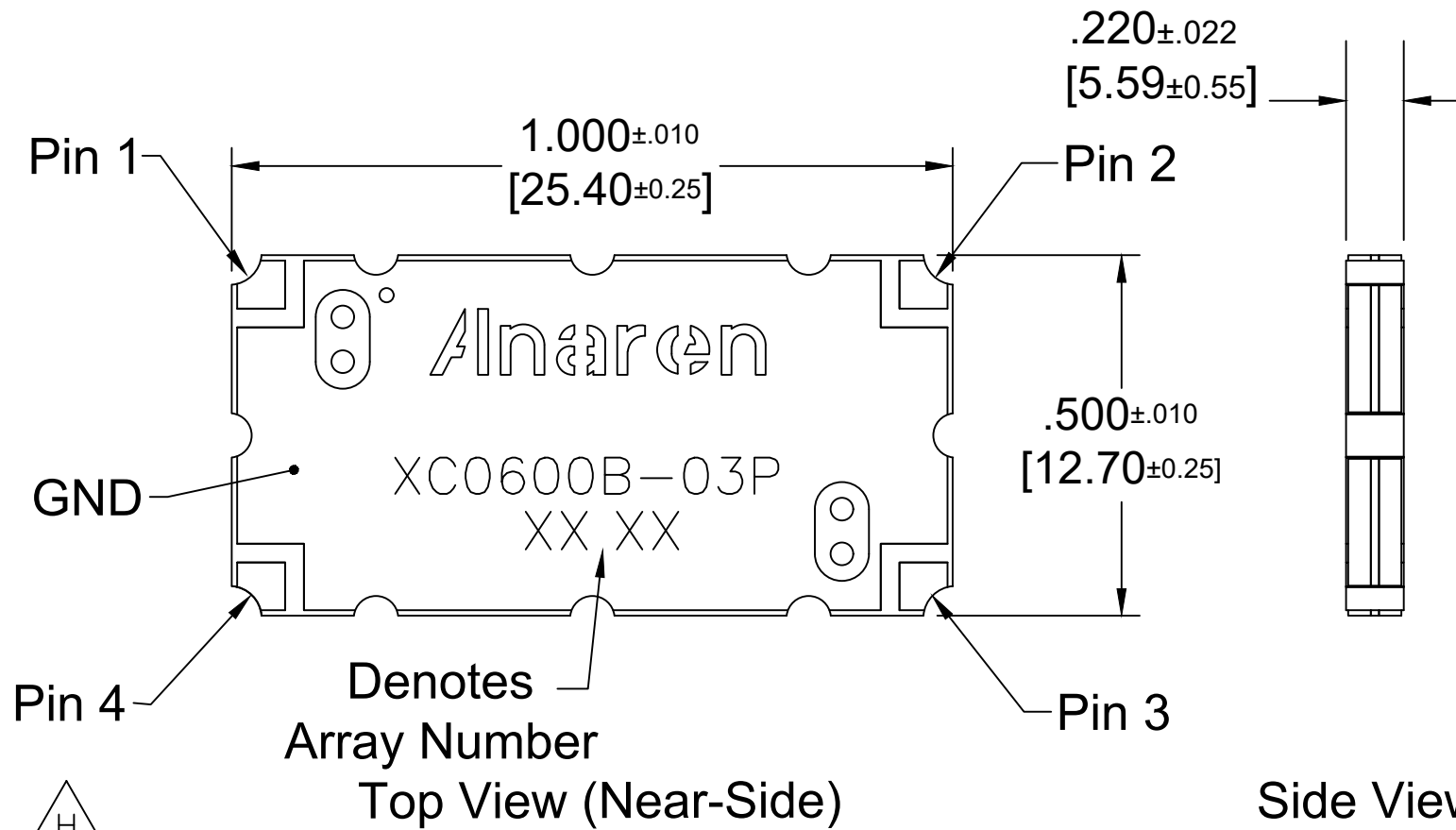

ELECTRICAL SPECIFICATIONS

Specification	Parameter		Comments
Frequency(MHz)	225-950	950-1000	
Insertion Loss	.7dB max	.7dB max	Room Temp Testing
Amplitude Balance	±.55dB max	±.90dB max	Excitation at Port 1
Phase Balance	90°±5°	90°±5°	Excitation at Port 1
Return Loss	17dB min	17dB min	All Ports
Isolation	17dB min.	17dB min.	S21 & S43
Avg. CW Power	75 watts	75 watts	
Operating Temperature	-54°C (-65°F) to +95°C (203°F)		

HYBRID COUPLER PIN CONFIGURATION

Pin 1	Pin 2	Pin 3	Pin 4
Input	Isol	-90 Degree	0 Degree
Isol	Input	0 Degree	-90 Degree
-90 Degree	0 Degree	Input	Isol
0 Degree	-90 Degree	Isol	Input

NOTES:

- 1 MARKING SHALL BE ETCHED ON SIDE AS SHOWN
- 2 DIMENSIONS ARE IN INCHES AND (MILLIMETERS)
- 3 FINISH: TIN LEAD PLATING 60/40 BRIGHT ELECTRODEPOSITED (REF. MIL-P-81728).

UNLESS OTHERWISE SPECIFIED
DIMENSIONS ARE IN INCHES
-TOLERANCES-

3 PL DEC ± .005
2 PL DEC ±
ANGLES ±

CONTRACT NO.

APPROVALS				YR	MO	DAY
DWN BY	David A. Nora	07	01	03		
DSGN BY						
ENGR BY						

THIRD ANGLE PROJECTION

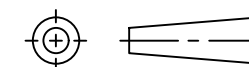

Anaren

ANAREN MICROWAVE INC.
EAST SYRACUSE, NEW YORK

PROCESS, SURFACE MOUNT
3db 90° HYBRID COUPLER

SIZE	CAGE CODE	DOC NO.
B	31597	PRC02967
SCALE	DOC CODE	REV
4/1	88	H
SHEET		1 OF 13

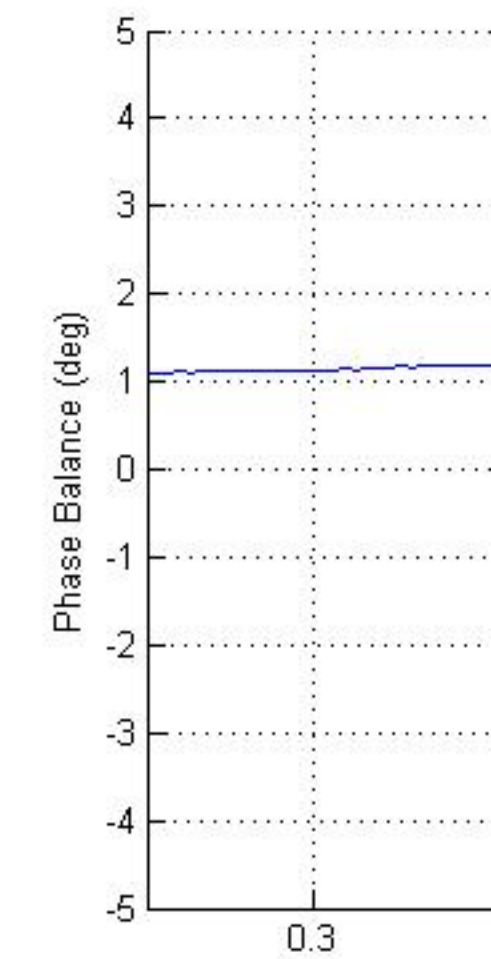
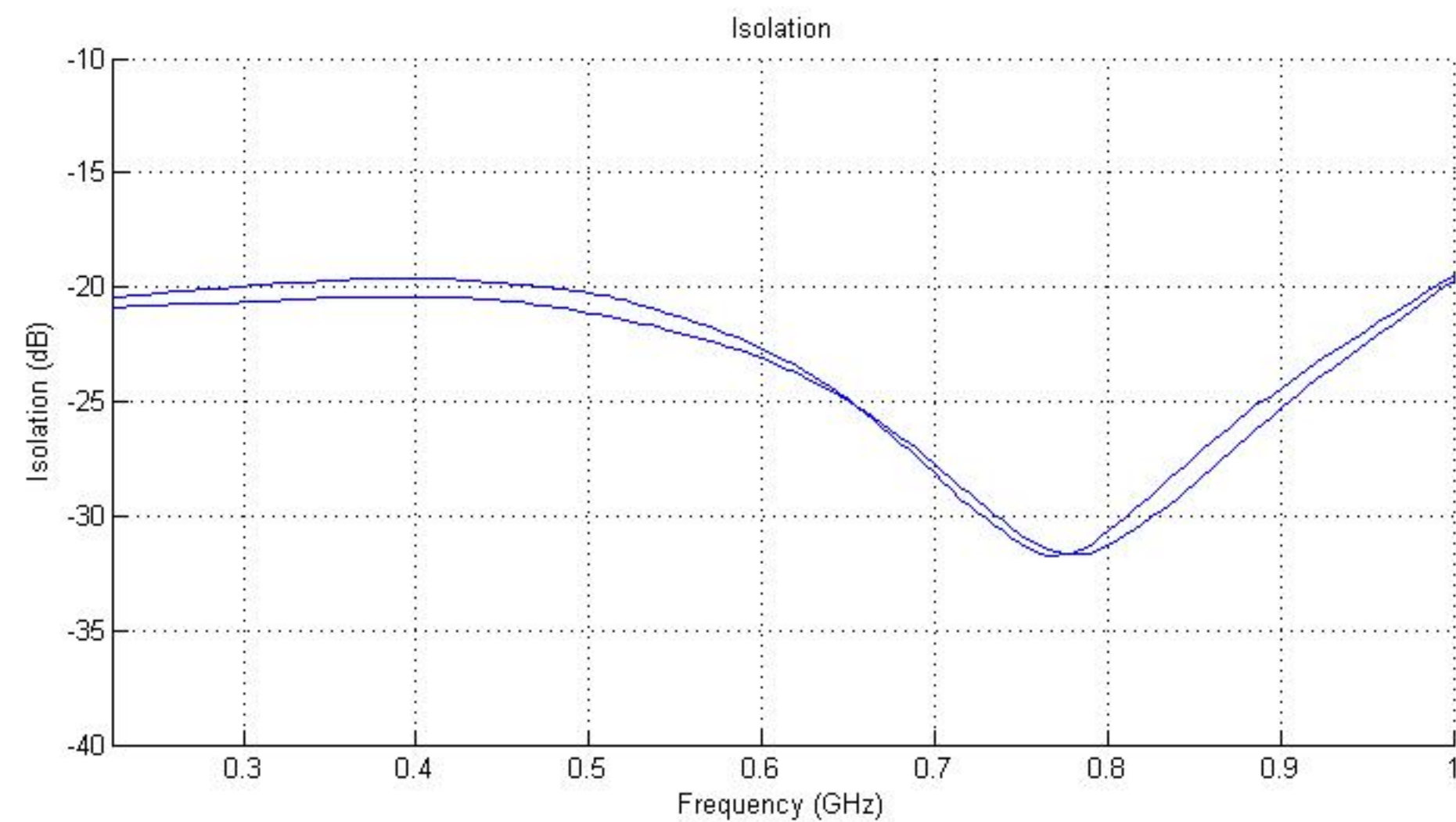
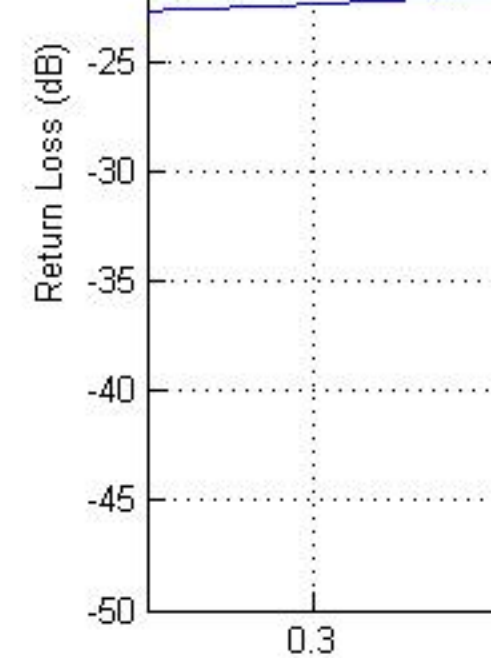
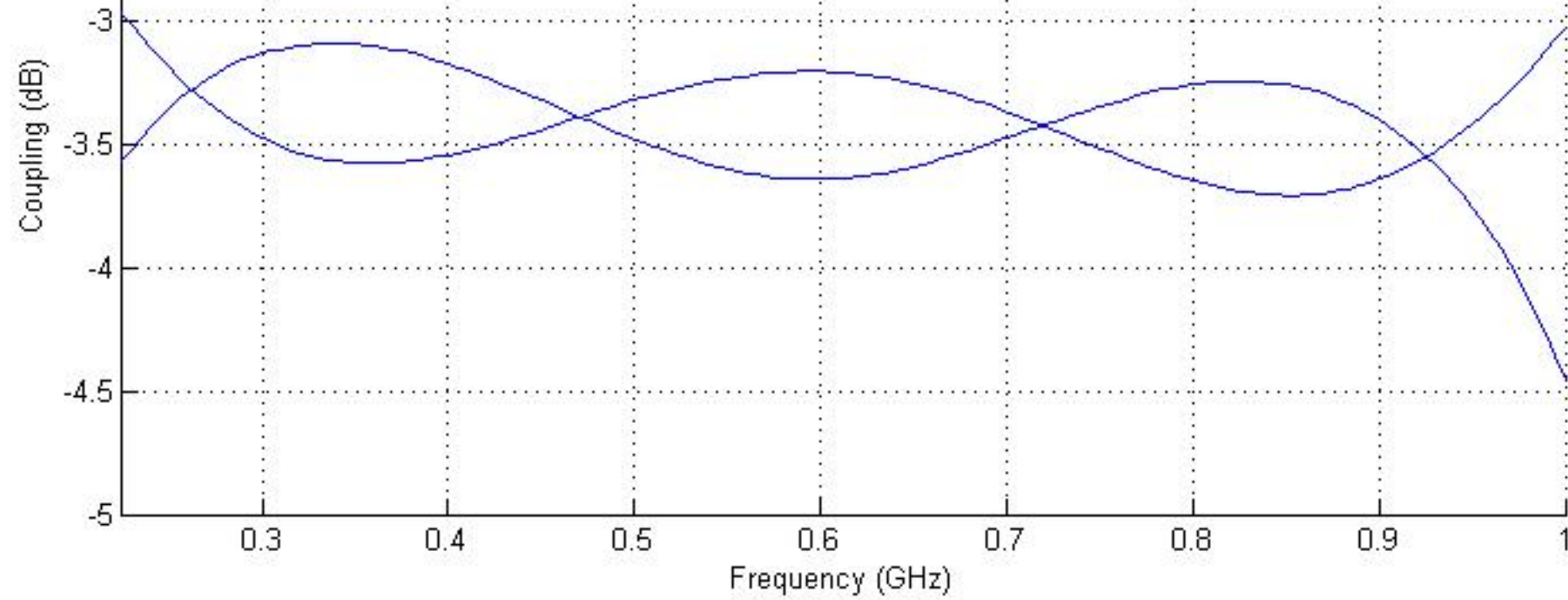

X-ON Electronics

Largest Supplier of Electrical and Electronic Components

Click to view similar products for [RF Connector Accessories](#) category:

Click to view products by [Anaren](#) manufacturer:

Other Similar products are found below :

[R280461210](#) [89674-0712](#) [F702RX24](#) [FERRULE-174](#) [9-225381-1](#) [9-228783-0](#) [R125802000](#) [R125812001](#) [R141805000](#) [R141842000](#)
[R141862000W](#) [R161853000W](#) [R161862000](#) [R161862000W](#) [R176811000](#) [R280752000](#) [R280907000](#) [R694261906](#) [RFI155-13-D4](#) [RFI21-13](#)
[RFI25-9](#) [RFI3157-7](#) [RFI75-13-D2](#) [RFI75-3](#) [RFI75-4-D2](#) [RFI97-13](#) [IPP-2013](#) [2098-0294-00](#) [2098-3251-94](#) [RUBBER-CAP-BNC](#) [9-225381-](#)
[0](#) [9-329099-2](#) [9-332224-1](#) [FERRULE-223](#) [202102-11](#) [213337-1](#) [220222-2](#) [24092671A](#) [24092678A](#) [R161841000](#) [R161841000W](#)
[R280510000](#) [R282862060](#) [RFI155-1](#) [RFI25-12-D3](#) [RFI25-5](#) [RFI25-5-D3](#) [RFI75-12-D2](#) [RFI75-4-D10](#) [RFI75-4-D3](#)