



**Analog Semiconductor IC**

# VDA Series

Low voltage, Low power,  $\pm 1\%$  High detect accuracy  
CMOS Voltage Detector

**(IMPORTANT: Please check the last page for Genuine Product Labeling)**

Rev. E13-01

Website: [www.anasemi.com](http://www.anasemi.com)  
Tel: +852-3590-8442  
Email: [sales@anasemi.com](mailto:sales@anasemi.com)

**AnaSem**  
..... Future of the analog world



# AnaSem

## Products Data Sheet

### Analog Semiconductor IC

Low voltage, Low power,  $\pm 1\%$  High detect accuracy CMOS Voltage Detector

## VDA Series

### GENERAL DESCRIPTIONS

The VDA series are voltage detectors with low voltage, low power consumption and high accuracy. The accuracy of the detection voltage is detected based on a voltage reference of high accuracy that the temperature coefficient is controlled. The detection voltage is made in high accuracy by using the laser trimming technology.



### FEATURES

- Detection voltage range ..... 0.8V~6.0V (selectable with a step of 0.1V)
- Operating voltage range ..... 0.7V~6.0V
- High accuracy detection voltage .....  $\pm 1\%$  ( $V_{DET}=1.8V\sim 6.0V$ ) /  $\pm 2\%$  ( $V_{DET}=0.8V\sim 1.7V$ )
- Detection voltage temperature characteristics ..... Typ.  $\pm 20\text{ppm}/^\circ\text{C}$  ( $V_{DET} = 1.8V\sim 6.0V$ )
- Output types ..... CMOS or N-channel open drain
- Low current consumption ..... Typ.  $0.6\mu\text{A}$  ( $V_{IN} = 1.5V$ )
- Operating temperature range .....  $-40^\circ\text{C} \sim +85^\circ\text{C}$
- Small package ..... SOT-23 (2.9x2.8x1.1mm)

### APPLICATIONS

- Reset of microprocessor
- Power-on reset of system
- Charge detection of battery
- Battery back-up of memory
- Monitoring of battery life time

**PRODUCTS NUMBERING GUIDE**



**PIN CONFIGURATION / MARKING SPECIFICATION (SOT-23)**

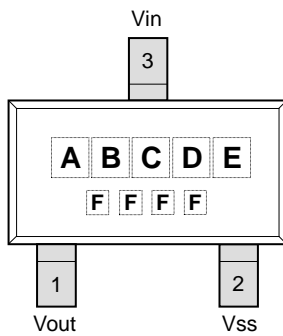

● **Pin Configuration**

No.	Symbol	Descriptions
1	VOUT	Output
2	VSS	Power ground
3	VIN	Voltage input

● **Marking Specification**

Code	Mark	Contents
A	C or N	Output type
BC	08~60	Detection voltage
D	1 or 2	Detection accuracy rate
E	A	Version
F	Internal rule	Lot number

## TYPICAL APPLICATION CIRCUITS

- CMOS output

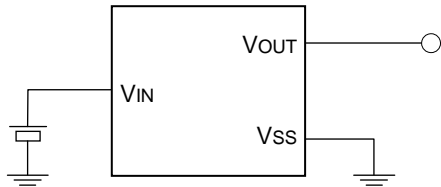

- N-channel open drain output

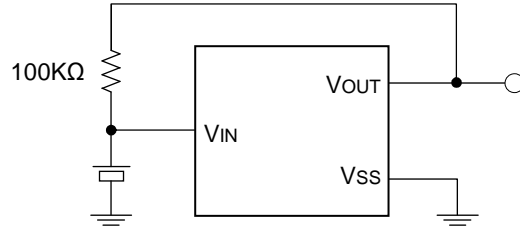

## BLOCK DIAGRAM

- CMOS output

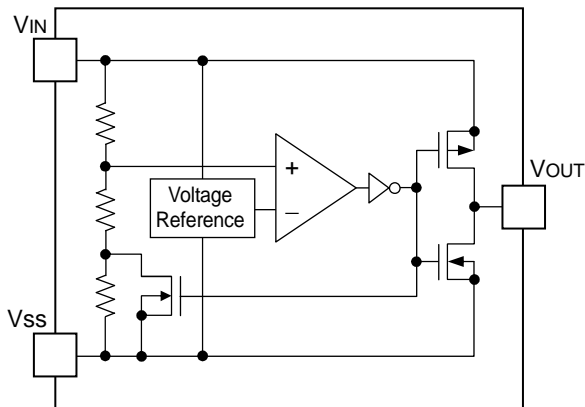

- N-channel open drain output



## ABSOLUTE MAXIMUM RATINGS

Items	Symbol	Ratings	Unit
Input voltage range	V <sub>IN</sub>	-0.3 ~ +7.0	V
Output current	I <sub>OUT</sub>	50	mA
Output voltage range	V <sub>OUT</sub>	V <sub>SS</sub> -0.3 ~ V <sub>IN</sub> +0.3	V
Power dissipation ※1)   SOT-23	P <sub>D</sub>	400	mW
Operating temperature range	T <sub>OPR</sub>	-40 ~ +85	°C
Storage temperature range	T <sub>STG</sub>	-55 ~ +125	°C

Note :

※1) Power dissipation depends on conditions of mounting on boards.  
PCB dimension is 50mm×50mm×1.6mm.

**ELECTRICAL CHARACTERISTICS**

(Ta=25°C unless otherwise specified)

Items	Symbol	Conditions	Min.	Typ.	Max.	Unit	Test circuit	
Operating voltage	V <sub>IN</sub>	V <sub>DET</sub> = 0.8V ~ 6.0V	0.7	-	6.0	V	1	
Detection voltage	V <sub>DET</sub>	V <sub>DET</sub> = 1.8V ~ 6.0V Ta = -40°C ~ +85°C	V <sub>DET</sub> x0.99	V <sub>DET</sub>	V <sub>DET</sub> x1.01	V	1	
	V <sub>DET</sub>	V <sub>DET</sub> = 0.8V ~ 1.7V Ta = -40°C ~ +85°C	V <sub>DET</sub> x0.98	V <sub>DET</sub>	V <sub>DET</sub> x1.02	V		
Hysteresis range	V <sub>HYS</sub>		V <sub>DET</sub> x0.02	V <sub>DET</sub> x0.05	V <sub>DET</sub> x0.08	V	1	
Output current	I <sub>OUT</sub>	N-ch V <sub>DS</sub> =0.5V	V <sub>IN</sub> =0.7V	0.1	0.35	-	mA	3
			V <sub>IN</sub> =1.0V	1.0	2.3	-	mA	
			V <sub>IN</sub> =2.0V	3.0	8.2	-	mA	
			V <sub>IN</sub> =3.0V	5.0	11.1	-	mA	
			V <sub>IN</sub> =4.0V	6.0	12.8	-	mA	
			V <sub>IN</sub> =5.0V	7.0	13.8	-	mA	
	CMOS P-ch V <sub>DS</sub> =2.1V	V <sub>IN</sub> =6.0V	-	-9.5	-1.5	mA	4	
CMOS N-ch V <sub>DS</sub> =2.1V	V <sub>IN</sub> =6.0V	1.5	9.5	-	mA	3		
Current consumption	I <sub>SS</sub>		V <sub>IN</sub> =1.5V	-	0.6	2.1	μA	2
			V <sub>IN</sub> =2.0V	-	0.7	2.5	μA	
			V <sub>IN</sub> =3.0V	-	0.8	2.8	μA	
			V <sub>IN</sub> =4.0V	-	0.9	3.0	μA	
			V <sub>IN</sub> =5.0V	-	1.0	3.4	μA	
Leak current	I <sub>LEAK</sub>	V <sub>IN</sub> =6.0V V <sub>OUT</sub> =6.0V	-	10	100	nA	3	
Detection voltage temperature coefficient	ΔV <sub>DET</sub> / ΔTa·V <sub>DET</sub>	V <sub>DET</sub> = 1.8V ~ 6.0V Ta = -40°C ~ +85°C	-	±20	-	ppm/°C	1	
		V <sub>DET</sub> = 0.8V ~ 1.7V Ta = -40°C ~ +85°C	-	±100	-	ppm/°C		
Delay time V <sub>DR</sub> →V <sub>OUT</sub> inversion	T <sub>DLY</sub>	Inverts from V <sub>DR</sub> to V <sub>OUT</sub>	-	0.03	0.2	ms	5	

**TEST CIRCUITS**

- **Circuit (1)** – Operating voltage, Detection voltage, Hysteresis range, Detection voltage temperature coefficient



Note 1) :  
The resistor (100kΩ) is not necessary for CMOS output products.

- **Circuit (2)** – Current consumption



- **Circuit (3)** – N-ch driver output current

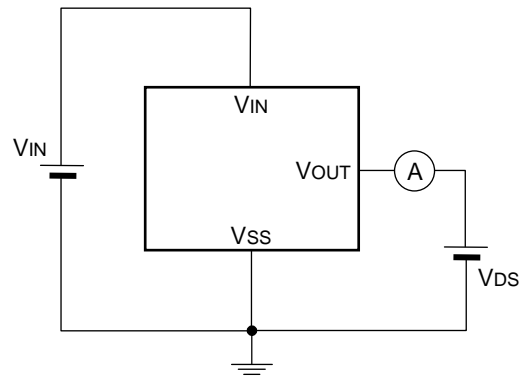

- **Circuit (4)** – P-ch driver output current



- **Circuit (5)** – Delay time (VDR→VOUT inversion)

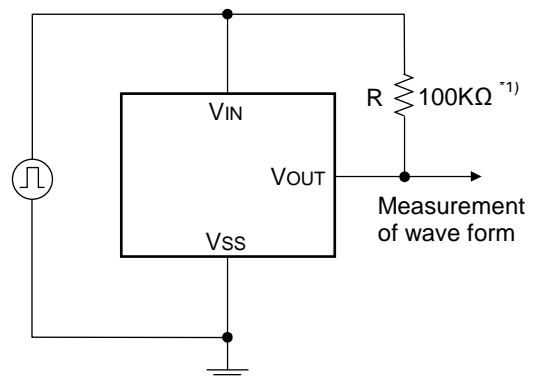

Note 1) :  
The resistor (100kΩ) is not necessary for CMOS output products.

## DESCRIPTION OF OPERATION

- **General operation (CMOS Output)**

In reference to following the block diagram of CMOS output VDA series ;



- When the input voltage ( $V_{IN}$ ) is higher than the release voltage ( $V_{REL}$ ), the input voltage ( $V_{IN}$ ) is provided at the output terminal because N-ch transistor is OFF and the P-ch transistor is ON. And, the output maintains the same level of input as long as the input voltage remains above the detection voltage ( $V_{DET}$ ).
- When the input voltage ( $V_{IN}$ ) falls below the detection voltage ( $V_{DET}$ ), the N-ch transistor is ON and the P-ch transistor is OFF. And, the output voltage ( $V_{OUT}$ ) is same as ground level ( $V_{SS}$ ).
- When the input voltage ( $V_{IN}$ ) falls below the minimum operating voltage, the output becomes unstable, or goes to  $V_{IN}$  when the output is pulled up to  $V_{IN}$ .
- When the input voltage ( $V_{IN}$ ) rises above the minimum voltage, the ground voltage ( $V_{SS}$ ) level is maintained even though the input voltage ( $V_{IN}$ ) rises above the detection voltage ( $V_{DET}$ ) as long as it does not exceed the release voltage ( $V_{REL}$ ) level.
- When the input voltage ( $V_{IN}$ ) rises above the release voltage ( $V_{REL}$ ), the N-ch transistor becomes OFF and the P-Ch transistor becomes ON. And, the output voltage ( $V_{OUT}$ ) is equal to input voltage ( $V_{IN}$ ). This difference between  $V_{DET}$  and  $V_{REL}$  is hysteresis range ( $V_{HYS}$ ).



**TYPICAL CHARACTERISTICS – Supply Current vs. Input Voltage**

● **VDA2010CTA (CMOS 2.0V)**



● **VDA2510CTA (CMOS 2.5V)**



● **VDA1020NTA (N-ch 1.0V)**

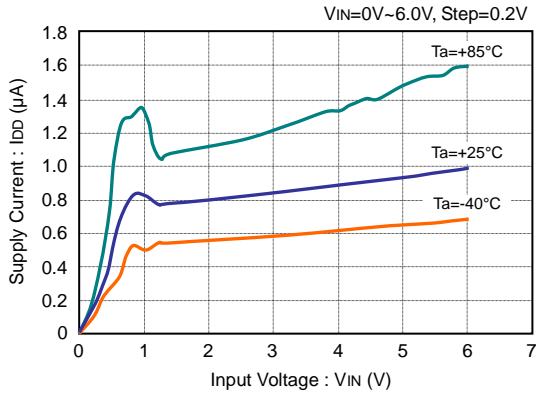

● **VDA1810NTA (N-ch 1.8V)**

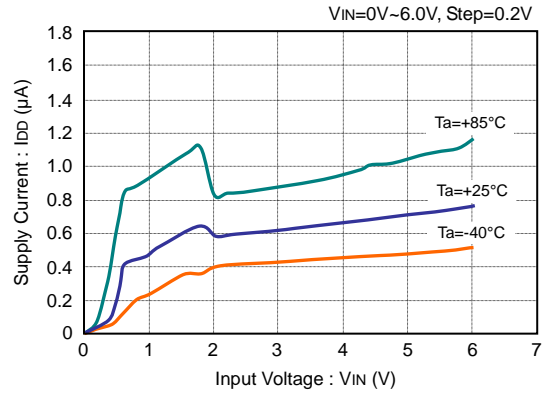

● **VDA2710NTA (N-ch 2.7V)**



● **VDA4010NTA (N-ch 4.0V)**





**TYPICAL CHARACTERISTICS – Detect & Release Voltage vs. Ambient Temperature**

● **VDA2010CTA (CMOS 2.0V)**



● **VDA2510CTA (CMOS 2.5V)**



● **VDA1020NTA (N-ch 1.0V)**



● **VDA1810NTA (N-ch 1.8V)**



● **VDA2710NTA (N-ch 2.7V)**



● **VDA4010NTA (N-ch 4.0V)**



**TYPICAL CHARACTERISTICS – Output Voltage vs. Input Voltage**

● **VDA2010CTA (CMOS 2.0V)**

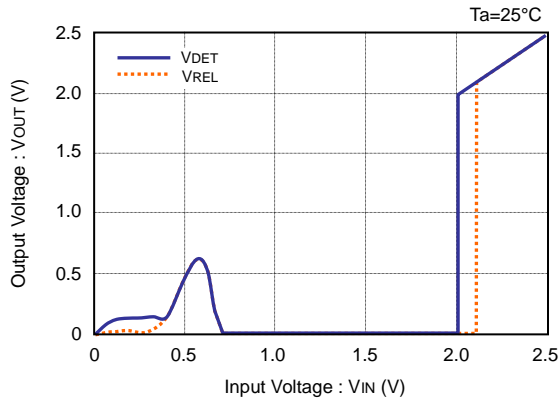

● **VDA2510CTA (CMOS 2.5V)**

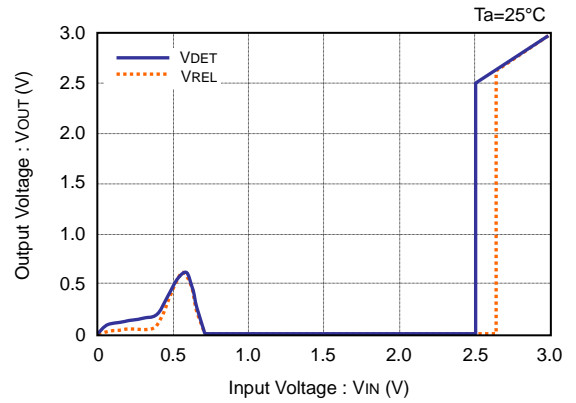

● **VDA1020NTA (N-ch 1.0V)**

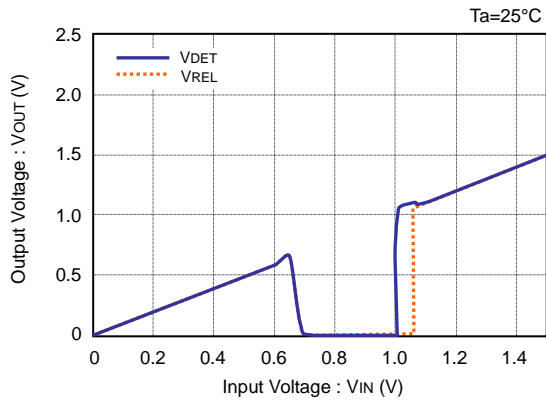

● **VDA1810NTA (N-ch 1.8V)**

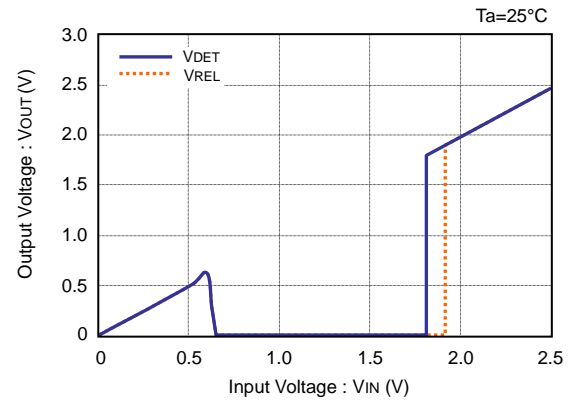

● **VDA2710NTA (N-ch 2.7V)**

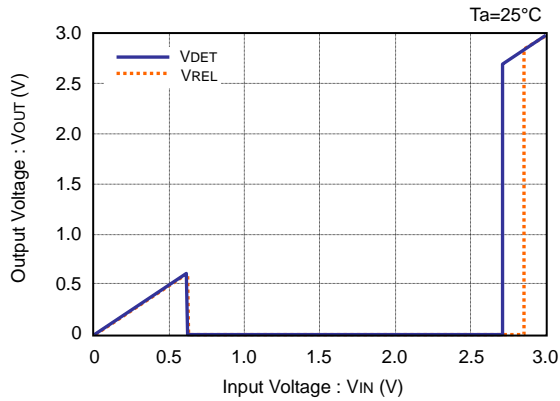

● **VDA4010NTA (N-ch 4.0V)**

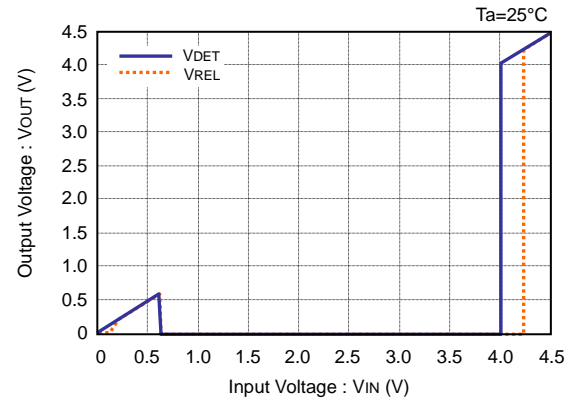

**TYPICAL CHARACTERISTICS – N-ch Driver Output Current vs.  $V_{DS}$**

● **VDA2010CTA (CMOS 2.0V)**



● **VDA2510CTA (CMOS 2.5V)**



● **VDA1020NTA (N-ch 1.0V)**



● **VDA1810NTA (N-ch 1.8V)**



● **VDA2710NTA (N-ch 2.7V)**



● **VDA4010NTA (N-ch 4.0V)**



**TYPICAL CHARACTERISTICS – N-ch Driver Output Current vs.  $V_{DS}$  (continued)**

● **VDA2010CTA (CMOS 2.0V)**

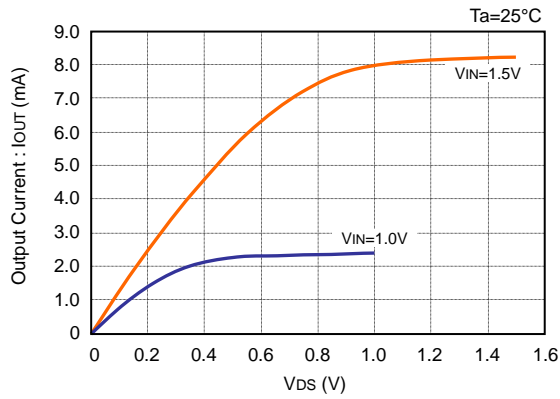

● **VDA2510CTA (CMOS 2.5V)**

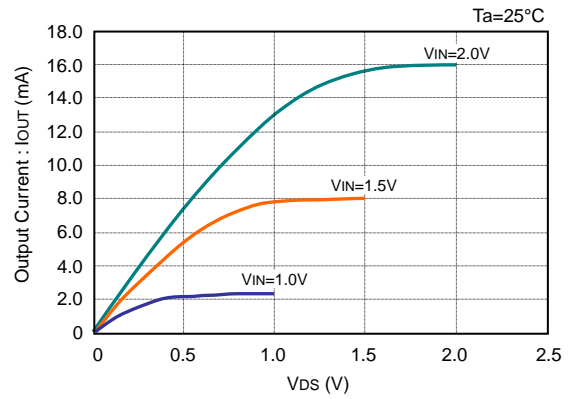

● **VDA1020NTA (N-ch 1.0V)**

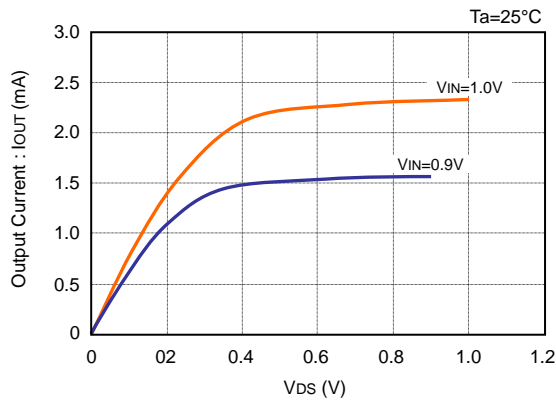

● **VDA1810NTA (N-ch 1.8V)**

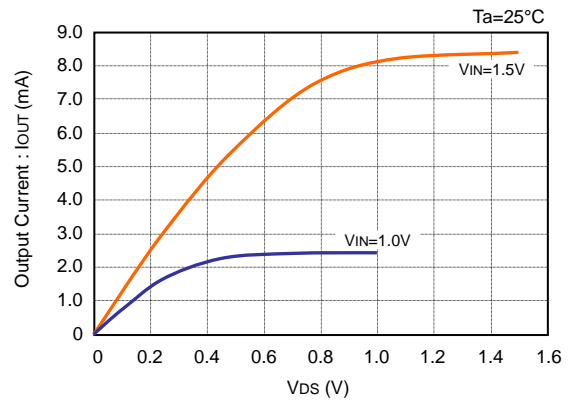

● **VDA2710NTA (N-ch 2.7V)**

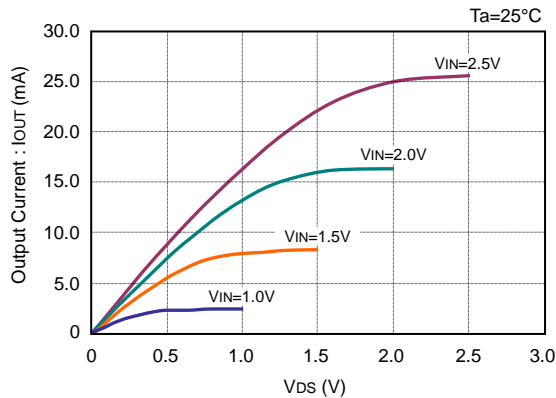

● **VDA4010NTA (N-ch 4.0V)**

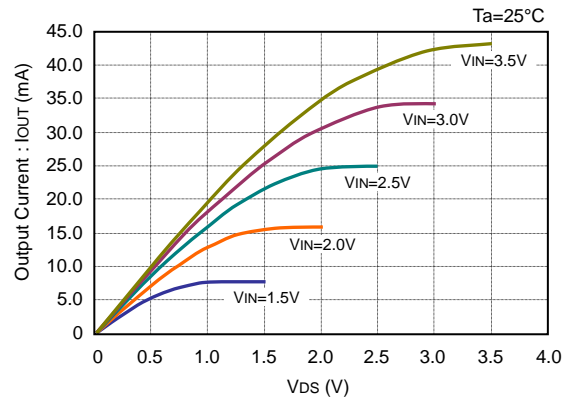

**TYPICAL CHARACTERISTICS – N-ch Driver Output Current vs. Input Voltage**

● **VDA2010CTA (CMOS 2.0V)**

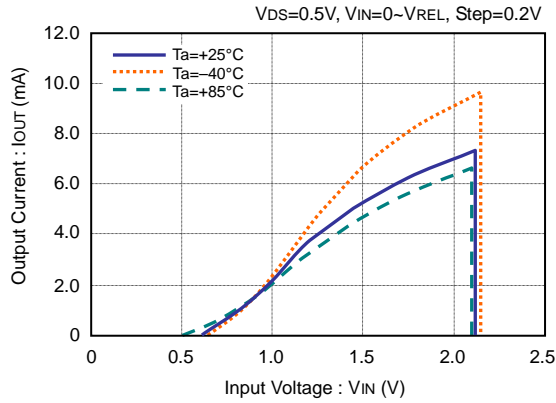

● **VDA2510CTA (CMOS 2.5V)**

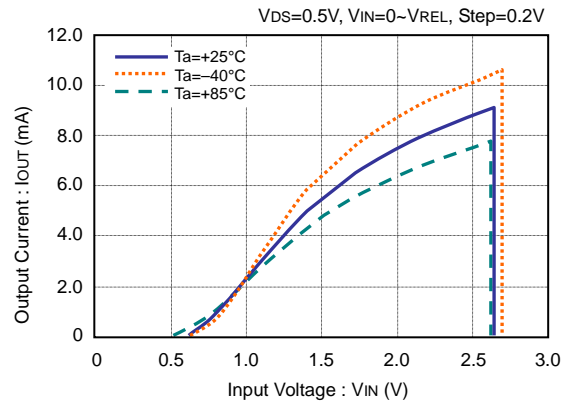

● **VDA1020NTA (N-ch 1.0V)**

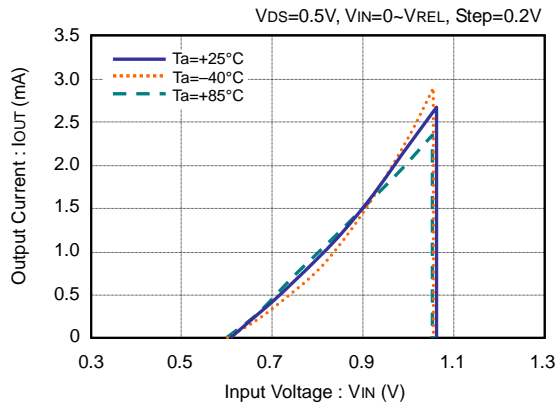

● **VDA1810NTA (N-ch 1.8V)**

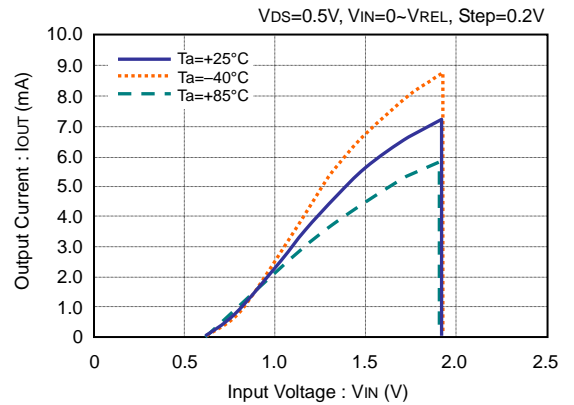

● **VDA2710NTA (N-ch 2.7V)**

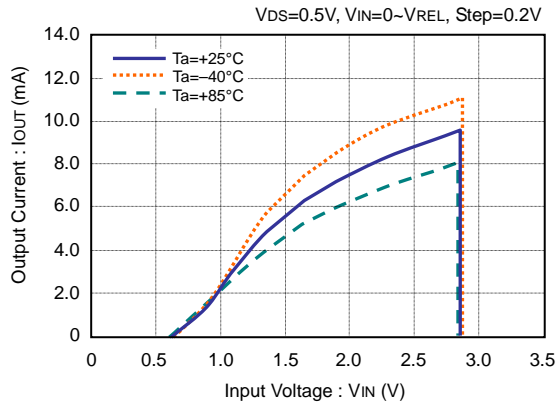

● **VDA4010NTA (N-ch 4.0V)**

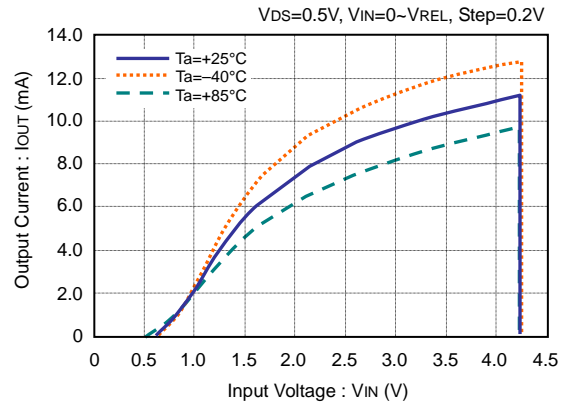

**TYPICAL CHARACTERISTICS – P-ch Driver Output Current vs. Input Voltage**

● **VDA2010CTA (CMOS 2.0V)**

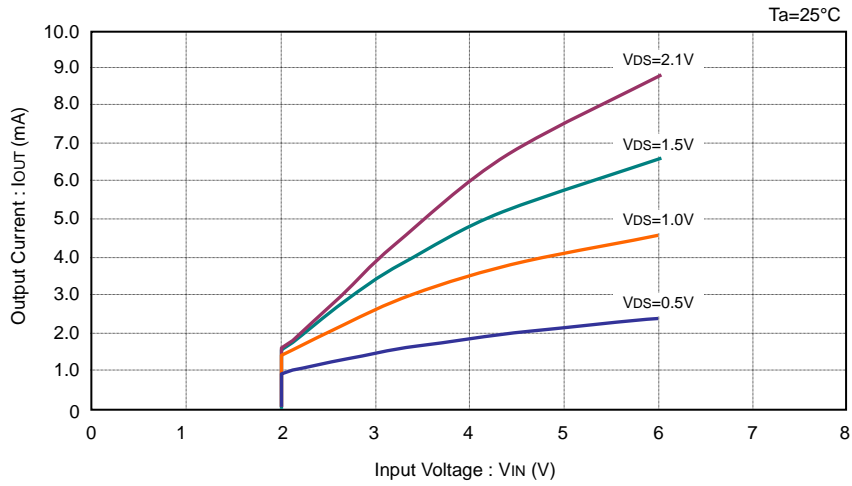

● **VDA2510CTA (CMOS 2.5V)**

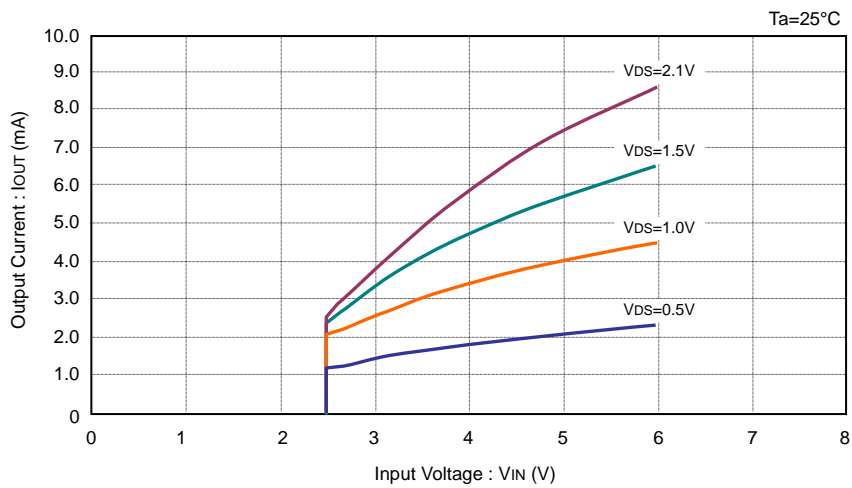

**PACKAGE DIMENSIONS (SOT-23)**

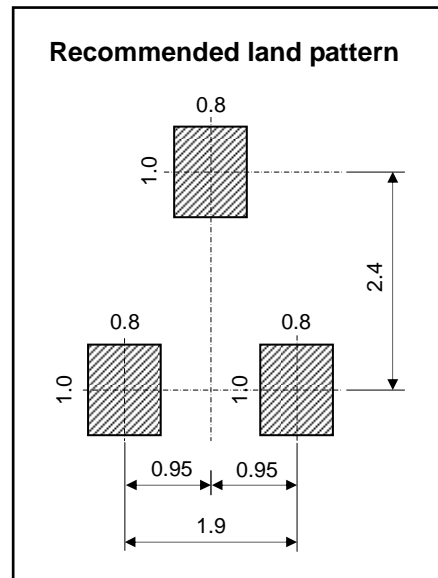
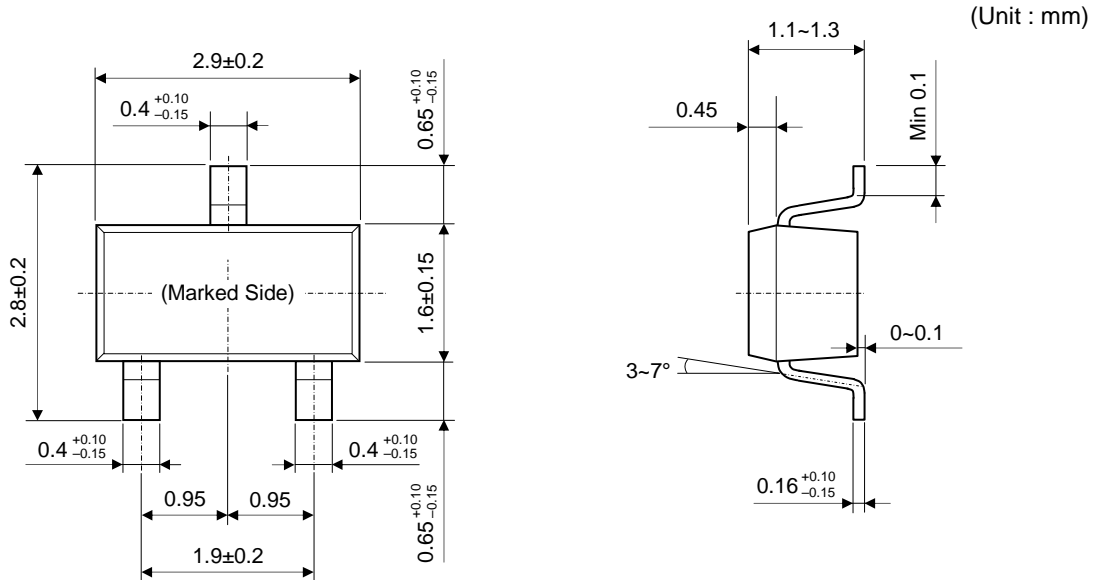

**TAPING AND LOADING SPECIFICATIONS (SOT-23)**



**REEL DIMENSIONS (SOT-23)**





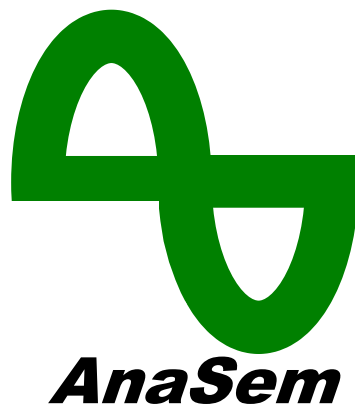

AnaSem may change the products described in this data sheet, or may discontinue production or services without any notice in order to supply the best products through improve the design and performance. Customers are recommended to obtain the latest data or information before placing orders in order to make sure the data or information required is the newest. It is necessary for customers to fully understand the products described in this data sheet and to use it in accordance with its specifications. The products described in this data sheet are not intended to use for the apparatus which have influence on human lives due to the failure or malfunction of the products. AnaSem Corp. is not responsible for any support to customer's application, product design, software performance, patent infringement or service. AnaSem Corp. does not disclose or imply a guarantee or description about being licensed based on patents, copy-rights, circuit location license, or other intellectual properties associated with the devices or combinations in which the products or service of AnaSem Corp. are used or can be used, or which cover the methods. Customers should not export, directly or indirectly, any products without obtaining required licenses and approvals in advance from appropriate government agencies.

## GENUINE PRODUCT LEGITIMATE LABEL DEFINITION



Green colored Circle "RoHS" Label

Ordinary Product Information Bar Code

AnaSem Logo and Brand Name (Black color Logo)

Other specific customized Labels

Our internal Outgoing Check Code 3

Our Internal QR Check Code 2

Our Internal Product Check Code 1

Genuine labels MUST include our correct contact information as shown

## X-ON Electronics

Largest Supplier of Electrical and Electronic Components

*Click to view similar products for [Supervisory Circuits](#) category:*

*Click to view products by [AnaSem](#) manufacturer:*

Other Similar products are found below :

[NCP304LSQ38T1G](#) [NCP304LSQ40T1G](#) [NCP304LSQ42T1G](#) [NCP304LSQ43T1G](#) [NCP304LSQ46T1G](#) [NCP305LSQ11T1G](#)  
[NCP305LSQ16T1G](#) [NCP305LSQ17T1G](#) [NCP305LSQ18T1G](#) [NCP305LSQ24T1G](#) [NCP305LSQ25T1G](#) [NCP305LSQ29T1G](#)  
[NCP305LSQ31T1G](#) [NCP305LSQ32T1G](#) [NCP308MT250TBG](#) [NCP308SN300T1G](#) [NCP391FCALT2G](#) [NCV303LSN42T1G](#)  
[NCV308SN330T1G](#) [CAT1161LI-25-G](#) [CAT853STBI-T3](#) [MAX1232CPA](#) [MAX705CPA](#) [CAT1026LI-30-G](#) [CAT1320LI-25-G](#) [CAT872-30ULGT3](#) [LA-ispPAC-POWR1014-01TN48E](#) [NCP304HSQ18T1G](#) [NCP304HSQ29T1G](#) [NCP304LSQ27T1G](#) [NCP304LSQ29T1G](#)  
[NCP304LSQ45T1G](#) [NCP305LSQ26T1G](#) [NCP305LSQ35T1G](#) [NCP305LSQ37T1G](#) [NCP308MT300TBG](#) [NCV300LSN36T1G](#)  
[NCV302LSN30T1G](#) [NCV303LSN16T1G](#) [NCV303LSN22T1G](#) [NCV303LSN27T1G](#) [NCV33161DMR2G](#) [TC54VN2402EMB713](#)  
[MCP1316T-44NE/OT](#) [MCP1316MT-45GE/OT](#) [MCP1316MT-23LI/OT](#) [MCP1316T-26LE/OT](#) [MAX8997EWW+](#) [MAX821RUS+T](#)  
[MAX6725AKASYD3-LF-T](#)