



***Analog Semiconductor IC***

# VRD Series

High speed, Low dropout,  $\pm 1\%$  High output accuracy  
CMOS Voltage Regulator with Dual output

**(IMPORTANT:** Please check the last page for Genuine Product Labeling)

Rev. E13-01

Website: [www.anasemi.com](http://www.anasemi.com)  
Tel: +852-3590-8442  
Email: [sales@anasemi.com](mailto:sales@anasemi.com)

**AnaSem**  
..... Future of the analog world



High speed, Low dropout,  $\pm 1\%$  High output accuracy Dual CMOS Voltage Regulator

## VRD Series

### GENERAL DESCRIPTIONS

The VRD series are dual positive voltage regulators with high speed, low voltage dropout and high accuracy output achieved by low current consumption. Because each regulator is completely separated, the crosstalk between each regulator can be reduced. The output voltage is guaranteed within  $\pm 1\%$  within the given temperature range by  $V_{ref}$  controlling the temperature characteristic. It corresponds to the low ESR capacitor as an output stabilization capacitor. The charged ESR capacitor can be discharged with an internal switch by making the  $CE=V_{SS}$ , as a result the  $V_{OUT}$  quickly returns to the  $V_{SS}$  level. To make the current capacity of the output transistor not exceeded, the over-current protection circuit is built in.



### FEATURES

- Output voltage range ..... 0.8V~5.0V (selectable with a step of 0.05V)
- Operating voltage range ..... 1.6V~6.0V
- High accuracy output voltage .....  $\pm 1\%$  ( $V_{out}=1.95V\sim 5.0V$ ) /  $\pm 20mV$  ( $V_{out}=0.8V\sim 1.9V$ )
- Maximum output current ..... 250mA / Channel
- Dropout voltage ..... Typ.90mV (output=3.0V,  $I_{OUT}=100mA$ )
- Low current consumption ..... Typ. 25 $\mu A$  / Channel
- High ripple rejection ..... Typ. 75dB at 1KHz
- Low ESR capacitor ..... 1.0  $\mu F$  ceramic capacitor
- Operating temperature range .....  $-40^{\circ}C \sim +85^{\circ}C$
- Built-in over-current protector ..... Limit current : 300mA
- CL high-speed auto-discharge
- Built-in On/Off circuit
- Small package ..... SOT-26 (2.9x2.8x1.1mm), LLP-6 (1.8x2.0x0.6mm)

### APPLICATIONS

- Battery powered devices
- Cellular phone
- Digital / Video cameras
- Portable games
- Handheld instruments

**PRODUCTS NUMBERING GUIDE**

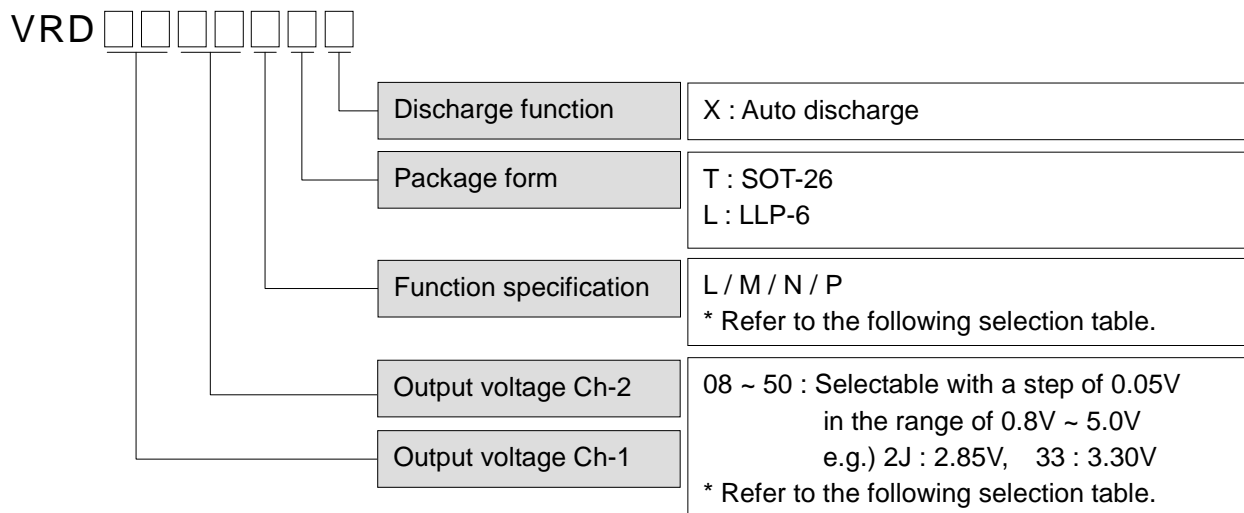

● **Function specification selection table**

Symbol	VR1	VR2	Function Specification
L	±20mv	±20mv	Vout1=0.80V~1.9V / Vout2=0.80V~1.9V
M	±20mv	±1%	Vout1=0.80V~1.9V / Vout2=1.95V~5.0V
N	±1%	±20mv	Vout1=1.95V~5.0V / Vout2=0.80V~1.9V
P	±1%	±1%	Vout1=1.95V~5.0V / Vout2=1.95V~5.0V

● **Output voltage selection table**

Symbol	Voltage	Symbol	Voltage	Symbol	Voltage	Symbol	Voltage	Symbol	Voltage
		1A	1.05	2A	2.05	3A	3.05	4A	4.05
		11	1.10	21	2.10	31	3.10	41	4.10
		1B	1.15	2B	2.15	3B	3.15	4B	4.15
		12	1.20	22	2.20	32	3.20	42	4.20
		1C	1.25	2C	2.25	3C	3.25	4C	4.25
		13	1.30	23	2.30	33	3.30	43	4.30
		1D	1.35	2D	2.35	3D	3.35	4D	4.35
		14	1.40	24	2.40	34	3.40	44	4.40
		1E	1.45	2E	2.45	3E	3.45	4E	4.45
		15	1.50	25	2.50	35	3.50	45	4.50
		1F	1.55	2F	2.55	3F	3.55	4F	4.55
		16	1.60	26	2.60	36	3.60	46	4.60
		1G	1.65	2G	2.65	3G	3.65	4G	4.65
		17	1.70	27	2.70	37	3.70	47	4.70
		1H	1.75	2H	2.75	3H	3.75	4H	4.75
08	0.80	18	1.80	28	2.80	38	3.80	48	4.80
0J	0.85	1J	1.85	2J	2.85	3J	3.85	4J	4.85
09	0.90	19	1.90	29	2.90	39	3.90	49	4.90
0K	0.95	1K	1.95	2K	2.95	3K	3.95	4K	4.95
10	1.00	20	2.00	30	3.00	40	4.00	50	5.00

**PIN CONFIGURATION / MARKING SPECIFICATION (SOT-26) - 1**

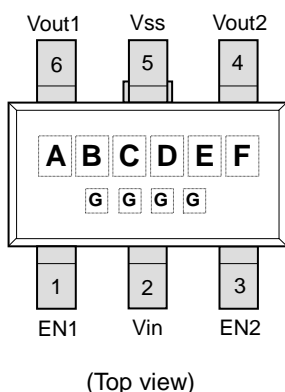

● **Pin Configuration**

No.	Symbol	Descriptions
1	EN1	1-Channel enable
2	VIN	Voltage input
3	EN2	2-Channel enable
4	VOUT2	2-Channel output
5	VSS	Power ground
6	VOUT1	1-Channel output

● **Marking Specification**

Code	Mark	Contents
A	D	Products series name
BC	08~50	1-Ch output voltage
DE	08~50	2-Ch output voltage
F	X	Discharge function
G	Internal rule	Lot number

**PIN CONFIGURATION / MARKING SPECIFICATION (SOT-26) - 2**

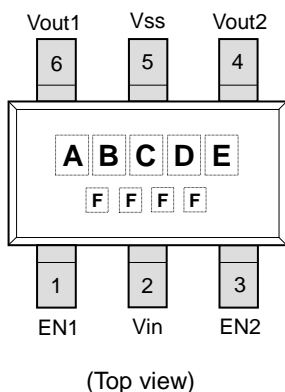

● **Pin Configuration**

No.	Symbol	Descriptions
1	EN1	1-Channel enable
2	VIN	Voltage input
3	EN2	2-Channel enable
4	VOUT2	2-Channel output
5	VSS	Power ground
6	VOUT1	1-Channel output

● **Marking Specification**

Code	Mark	Contents
A	D	Products series name
BC	08~50	1-Ch output voltage
DE	08~50	2-Ch output voltage
F	Internal rule	Lot number

## PIN CONFIGURATION / MARKING SPECIFICATION (LLP-6)

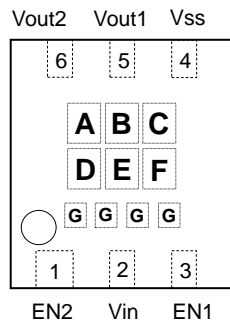

(Top view)

- Pin Configuration

No.	Symbol	Descriptions
1	EN2	2-Channel enable
2	VIN	Voltage input
3	EN1	1-Channel enable
4	VSS	Power ground
5	VOUT1	1-Channel output
6	VOUT2	2-Channel output

- Marking Specification

Code	Mark	Contents
A	D	Products series name
BC	08~50	1-Ch output voltage
DE	08~50	2-Ch output voltage
F	X	Discharge function
G	Internal rule	Lot number

**BLOCK DIAGRAM**

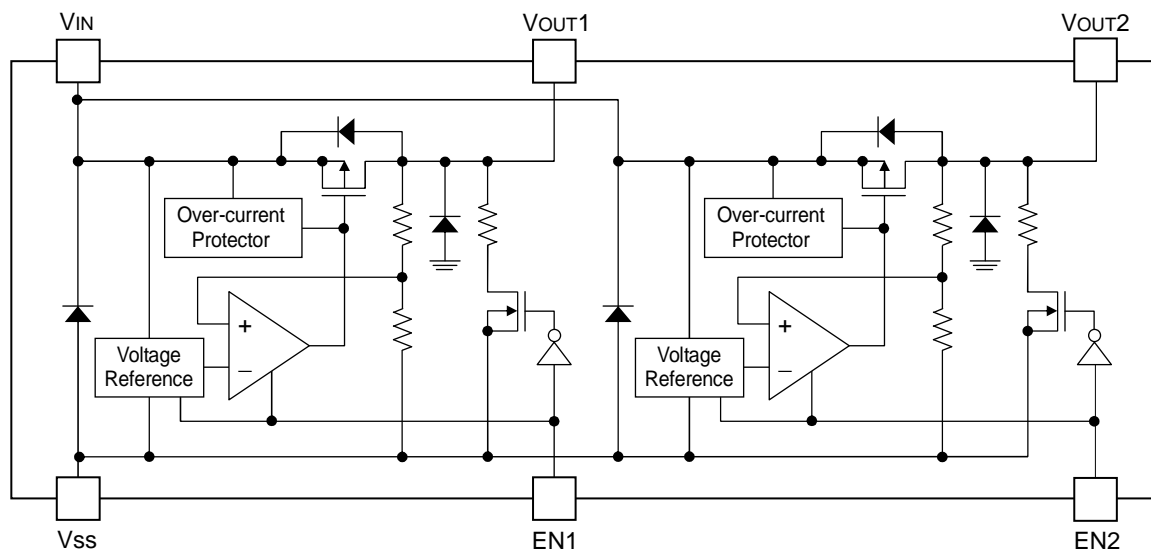

**ABSOLUTE MAXIMUM RATINGS**

Items	Symbol	Ratings	Unit	
Input voltage range	V <sub>IN</sub>	-0.3 ~ +7.0	V	
Output current	I <sub>OUT</sub>	500	mA	
Output voltage range	V <sub>OUT</sub>	V <sub>SS</sub> -0.3 ~ V <sub>IN</sub> +0.3	V	
Power dissipation ※1)	SOT-26	PD	600	mW
	LLP-6	PD	1000	mW
Operating temperature range	T <sub>OPR</sub>	-40 ~ +85	°C	
Storage temperature range	T <sub>STG</sub>	-55 ~ +125	°C	

Note :

※1) Power dissipation depends on conditions of mounting on boards. PCB dimension is 50mmx50mmx1.6mm.

**TYPICAL APPLICATION CIRCUITS**

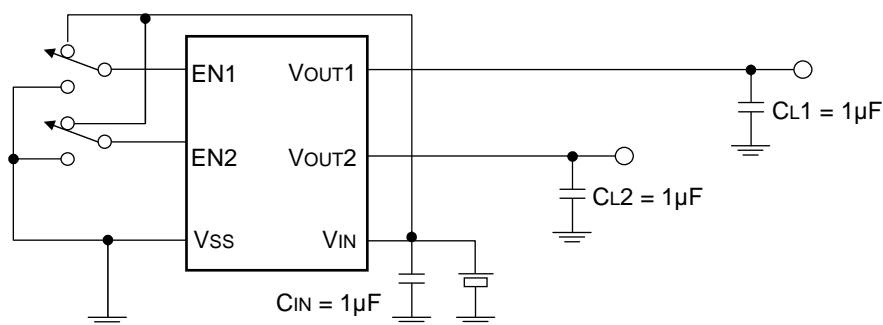

**ELECTRICAL CHARACTERISTICS**

(Ta=25°C unless otherwise specified)

Items	Symbol	Conditions		Min.	Typ.	Max.	Unit	Test circuit
Output voltage	V <sub>OUT</sub>	V <sub>OUT</sub> +1.0V ≤ V <sub>IN</sub> ≤ 6.0V I <sub>OUT</sub> =30mA Ta=-40°C ~ +85°C	V <sub>OUT</sub> ≥ 1.95V	V <sub>OUT</sub> × 0.99	V <sub>OUT</sub>	V <sub>OUT</sub> × 1.01	V	1
			V <sub>OUT</sub> ≤ 1.90V	-20	-	+20	mV	
Output current	I <sub>OUT</sub>	V <sub>IN</sub> ≥ V <sub>OUT</sub> +1.0V	0.9V ≤ V <sub>OUT</sub> ≤ 1.15V	-	250	-	mA	1
			1.2V ≤ V <sub>OUT</sub> ≤ 1.65V	-	250	-	mA	
			1.7V ≤ V <sub>OUT</sub> ≤ 2.25V	-	250	-	mA	
			2.3V ≤ V <sub>OUT</sub> ≤ 2.85V	-	250	-	mA	
			2.9V ≤ V <sub>OUT</sub> ≤ 3.45V	-	250	-	mA	
			3.5V ≤ V <sub>OUT</sub> ≤ 4.05V	-	250	-	mA	
			4.0V ≤ V <sub>OUT</sub> ≤ 5.00V	-	250	-	mA	
Dropout voltage	V <sub>DROP</sub>	I <sub>OUT</sub> =100mA	0.9V ≤ V <sub>OUT</sub> ≤ 1.15V	-	580	910	mV	1
			1.2V ≤ V <sub>OUT</sub> ≤ 1.65V	-	210	340	mV	
			1.7V ≤ V <sub>OUT</sub> ≤ 2.25V	-	130	205	mV	
			2.3V ≤ V <sub>OUT</sub> ≤ 2.85V	-	100	150	mV	
			2.9V ≤ V <sub>OUT</sub> ≤ 3.45V	-	90	137	mV	
			3.5V ≤ V <sub>OUT</sub> ≤ 4.05V	-	85	125	mV	
			4.1V ≤ V <sub>OUT</sub> ≤ 5.00V	-	80	115	mV	

**ELECTRICAL CHARACTERISTICS (CONTINUED)**

(Ta=25°C unless otherwise specified)

Items	Symbol	Conditions	Min.	Typ.	Max.	Unit	Test circuit
Current consumption	I <sub>DD</sub>	V <sub>IN</sub> =V <sub>OUT</sub> +1.0V, V <sub>OUT</sub> =Open, I <sub>OUT</sub> =0mA	-	50	80	μA	2
Standby current	I <sub>STB</sub>	EN=V <sub>SS</sub>	-	0.01	0.1	μA	2
Input voltage	V <sub>IN</sub>		1.6	-	6.0	V	1
Load regulation	ΔV <sub>OUT</sub>	V <sub>IN</sub> =V <sub>OUT</sub> +1.0V, I <sub>OUT</sub> =0.1mA ~100mA	-	10	40	mV	1
Line regulation	$\frac{\Delta V_{OUT}}{\Delta V_{IN} \cdot V_{OUT}}$	V <sub>OUT</sub> +1.0V ≤ V <sub>IN</sub> ≤ 6.0V, I <sub>OUT</sub> =30mA	-	0.01	0.1	%/V	1
Ripple rejection	R <sub>r</sub>	V <sub>IN</sub> =V <sub>OUT</sub> +1.0V, f=1KHz, ΔV <sub>RIP</sub> =0.5VP-P, I <sub>OUT</sub> =30mA	-	75	-	dB	3
Limit current	I <sub>LIMIT</sub>	EN=V <sub>IN</sub>	300	-	-	mA	1
Short circuit current	I <sub>SHORT</sub>	V <sub>IN</sub> =V <sub>OUT</sub> +1.0V, V <sub>OUT</sub> =0V	-	40	-	mA	1
Output voltage temperature coefficient	$\frac{\Delta V_{OUT}}{\Delta T_a \cdot V_{OUT}}$	V <sub>EN</sub> =V <sub>IN</sub> , I <sub>OUT</sub> =300mA Ta=-40°C ~ +85°C		±20		ppm /°C	1
EN high level voltage	V <sub>ENH</sub>		1.2	-	6.0	V	1
EN low level voltage	V <sub>ENL</sub>		-	-	0.3	V	1
EN high level current	I <sub>ENH</sub>	V <sub>EN</sub> = V <sub>IN</sub>	-0.1	-	0.1	μA	1
EN low level current	I <sub>ENL</sub>	V <sub>EN</sub> = V <sub>SS</sub>	-0.1	-	0.1	μA	1
CL auto-discharge resistance	R <sub>DIS</sub>	V <sub>IN</sub> =6.0V, V <sub>OUT</sub> =4.0V, V <sub>EN</sub> = V <sub>SS</sub>	-	160	-	Ω	1



## TEST CIRCUITS

- **Circuit (1)** - Output voltage, Output current, Dropout voltage, Input voltage, Load regulation, Line regulation, Limit current, Short circuit current, Output voltage temperature coefficient, CL auto-discharge resistance, EN high level voltage, EN low level voltage, EN high level current, EN low level current

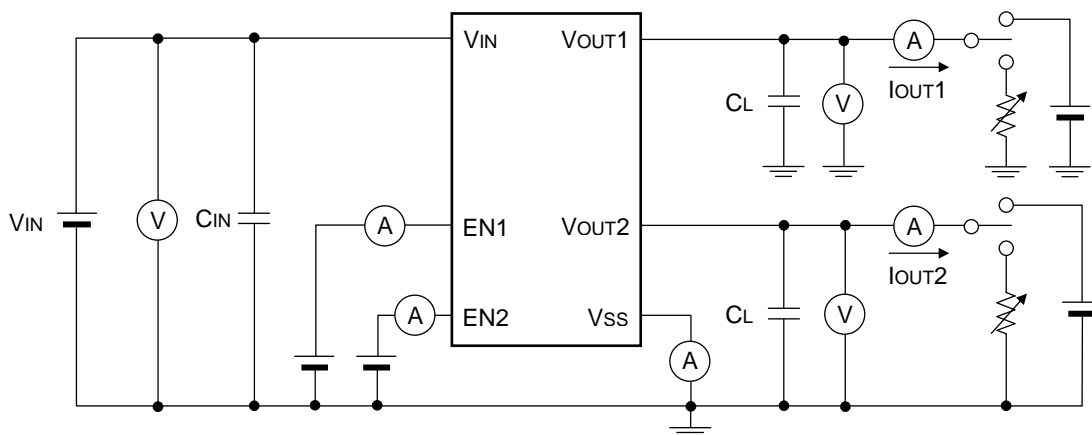

- **Circuit (2)** - Current consumption, Standby current

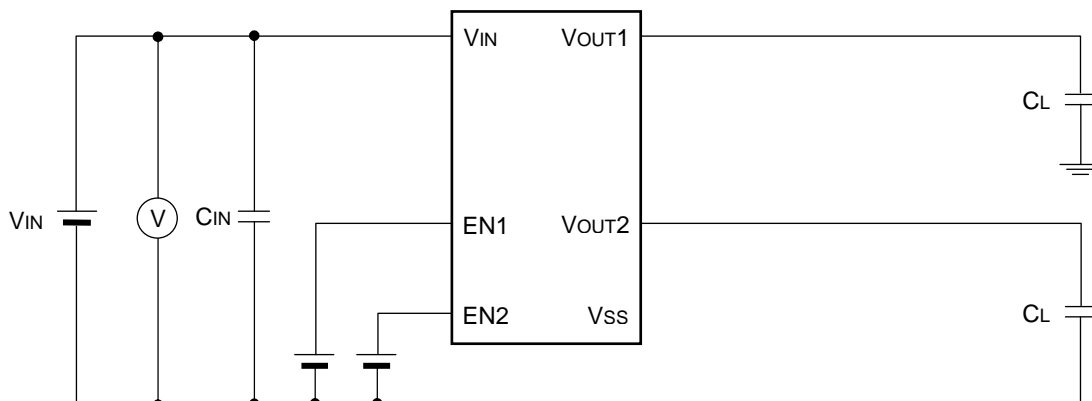

- **Circuit (3)** - Ripple rejection

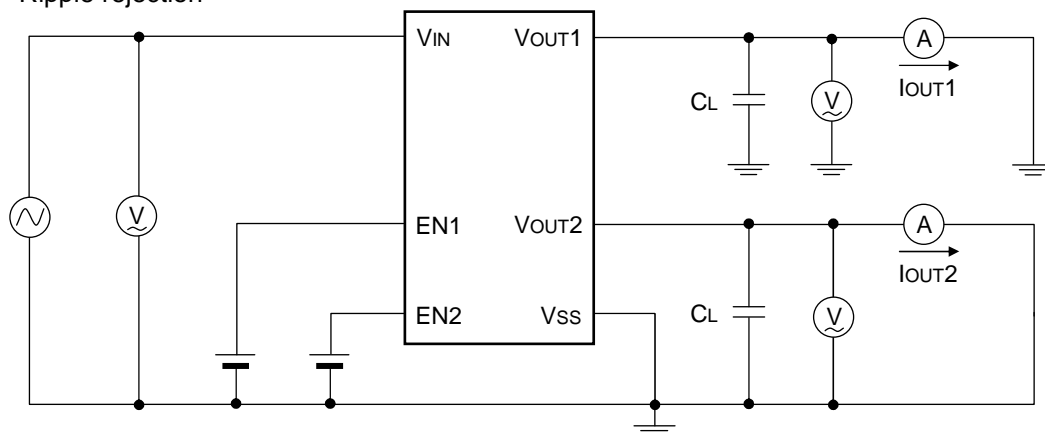

## DESCRIPTION OF OPERATION

### ● General operation

In reference to following a part of the block diagram of output voltage control of the VRD series ;

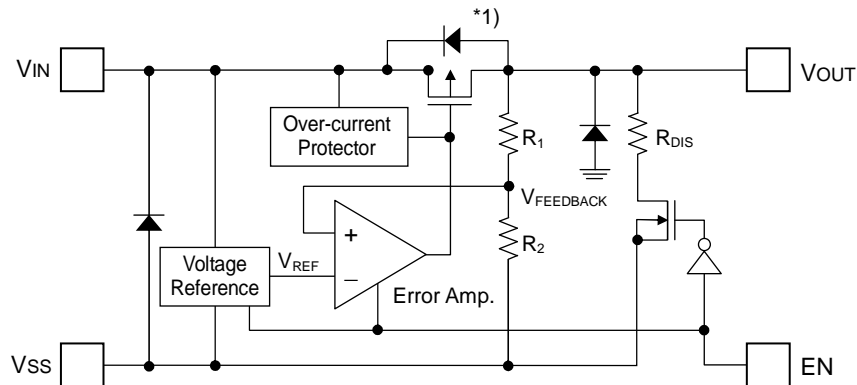

By the error amplifier, the reference voltage ( $V_{REF}$ ) is compared with  $V_{FEEDBACK}$  which is divided by feedback resistors  $R_1$  and  $R_2$ . It supplies the output transistor (see note \*1) to keep a stabilized output voltage against with any fluctuation of input voltage by negative feedback system.

Note \*1)

The VRD series has P-channel MOSFET which is connected to the VOUT terminal as the output transistor. To prevent the VRD series from being damaged due to inverse current from VOUT terminal to VIN terminal through a parasitic diode, VOUT should not be exceeded  $V_{IN} + 0.3V$ .

### ● EN terminal (shutdown function) & CL auto-discharge

The VRD series can be shutdown through EN terminal. The P-channel MOSFET is turned off and operation of all internal circuits stops to reduce the current consumption when the signal of EN terminal is set to the shutdown level. In shutdown mode, the VRD series enables the electric charge at the CL to be discharged via the auto-discharge resistance ( $R_{DIS}$  ;  $160\Omega$ ), and the VOUT terminal can be rapidly returned to the VSS level as a result.

### ● Output capacitor (CL)

For phase compensation, an output capacitor ( $C_L$ ) is required to connected between VOUT terminal and VSS terminal as close as possible. A ceramic capacitor with capacitance value of at least  $1.0\mu F$  is recommended. Of course, the suitable capacitance value should be different by the condition of each application. In addition, an input capacitor ( $C_{IN}$ ) with capacitance value of at least  $1.0\mu F$  is also recommended between VIN terminal and VSS terminal for stable input power.

### ● Over current protection and short circuit protection

Built-in over current protection circuit performs circuit protection from over current as a current limiter. When the load current reaches the limit level, the output voltage drops and output current also decreases accordingly. A current of typ.  $40mA$  will flow when output terminal is shorted.

**TYPICAL CHARACTERISTICS – Output Voltage vs. Output Current**

● **VRD (V<sub>OUT</sub>=1.5V)**

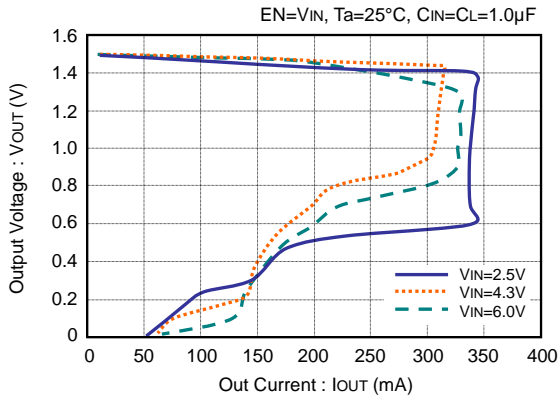

● **VRD (V<sub>OUT</sub>=1.5V)**

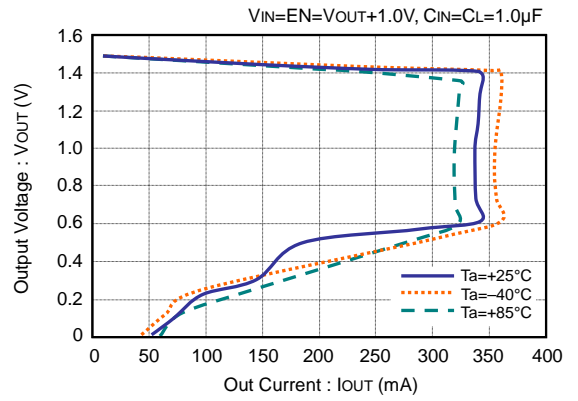

● **VRD (V<sub>OUT</sub>=1.8V)**

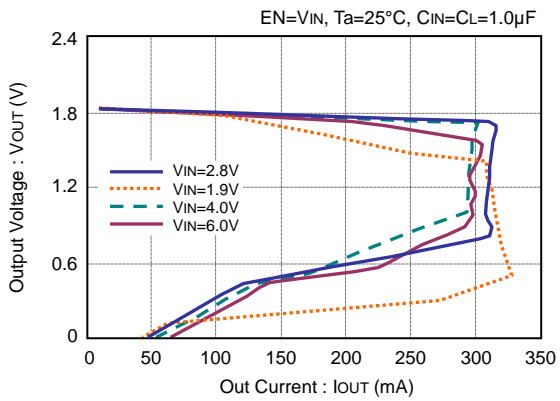

● **VRD (V<sub>OUT</sub>=1.8V)**

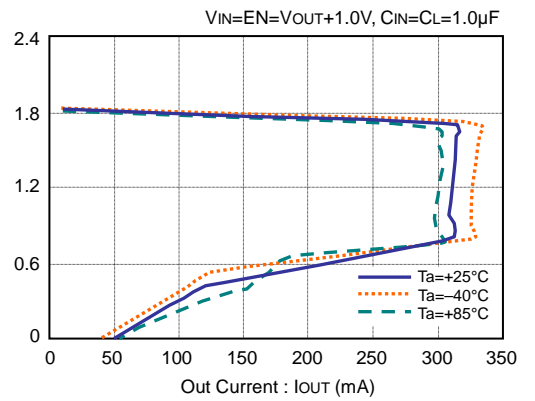

**TYPICAL CHARACTERISTICS – Output Voltage vs. Output Current (continued)**

● **VRD (V<sub>OUT</sub>=2.8V)**

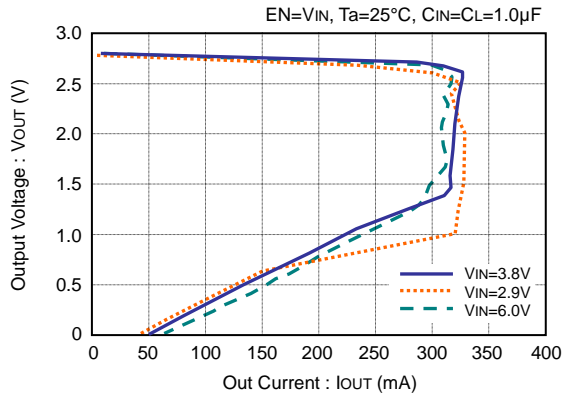

● **VRD (V<sub>OUT</sub>=2.8V)**

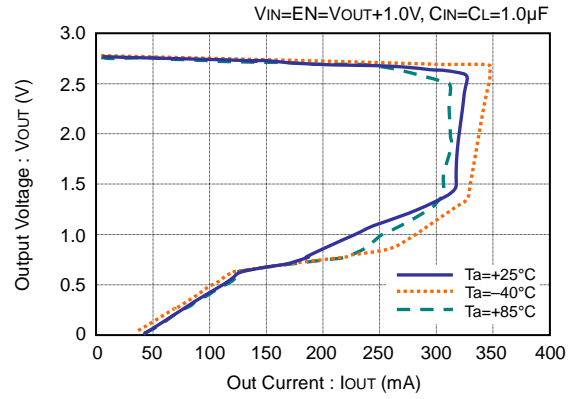

● **VRD (V<sub>OUT</sub>=3.3V)**

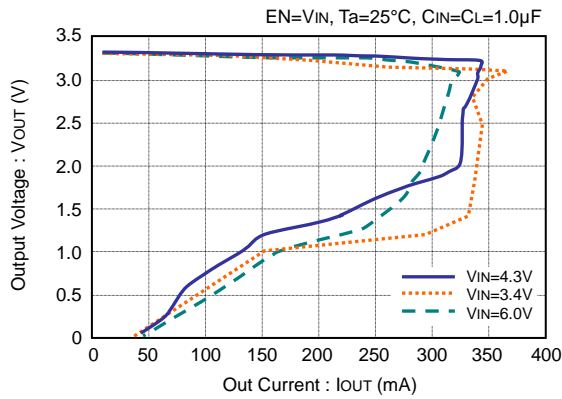

● **VRD (V<sub>OUT</sub>=3.3V)**

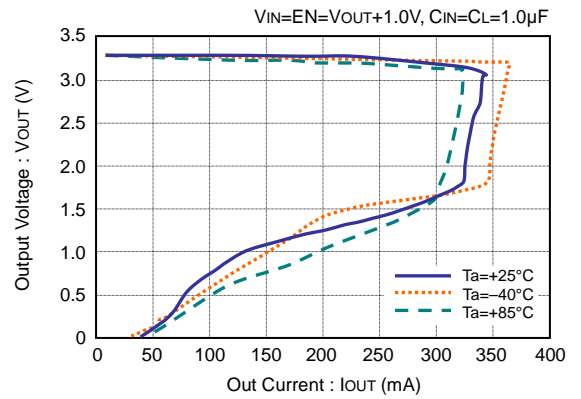

**TYPICAL CHARACTERISTICS – Output Voltage vs. Input Voltage**

● **VRD (V<sub>OUT</sub>=1.5V)**

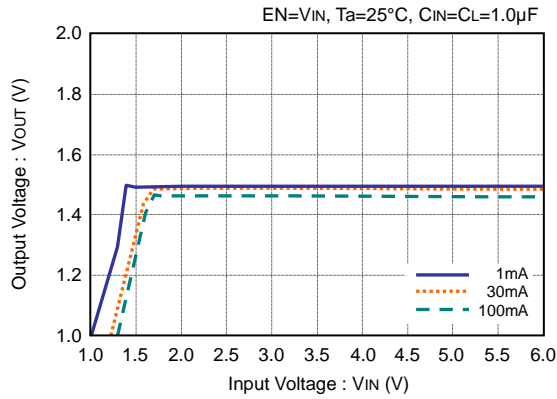

● **VRD (V<sub>OUT</sub>=1.5V)**

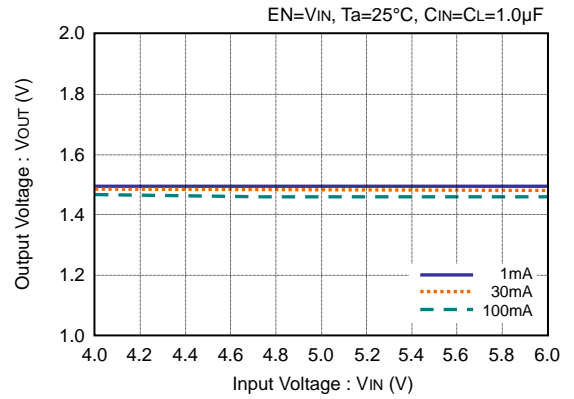

● **VRD (V<sub>OUT</sub>=1.8V)**

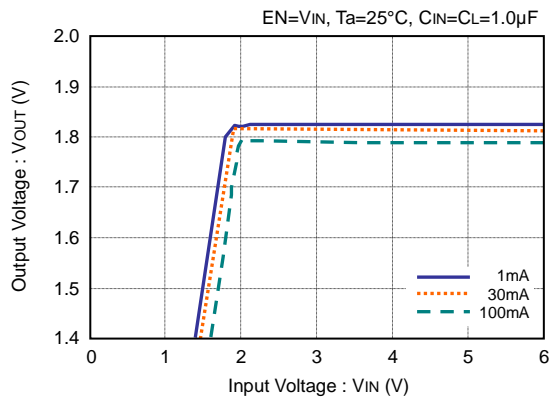

● **VRD (V<sub>OUT</sub>=1.8V)**

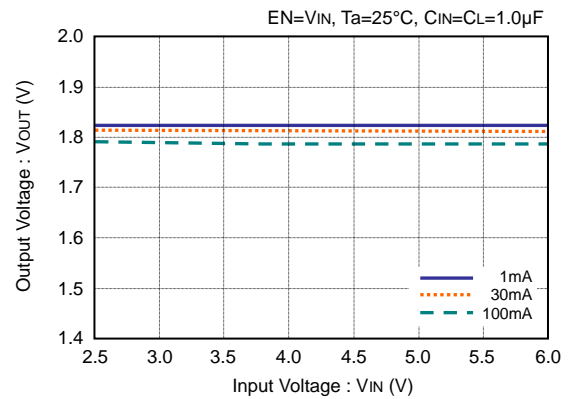

**TYPICAL CHARACTERISTICS – Output Voltage vs. Input Voltage (continued)**

● **VRD (V<sub>OUT</sub>=2.8V)**

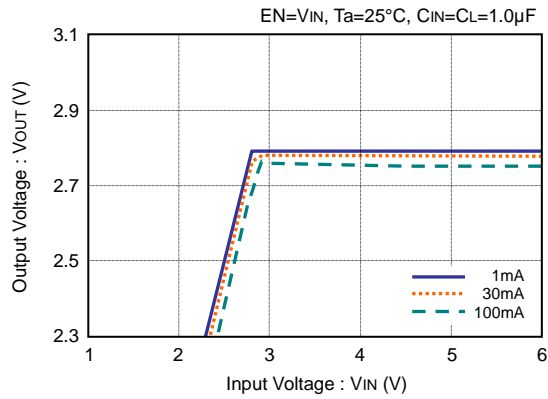

● **VRD (V<sub>OUT</sub>=2.8V)**

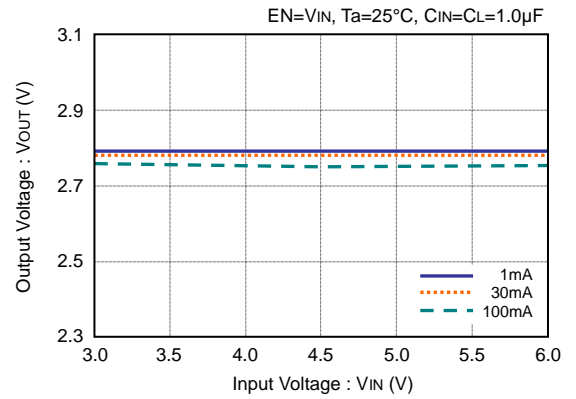

● **VRD (V<sub>OUT</sub>=3.3V)**

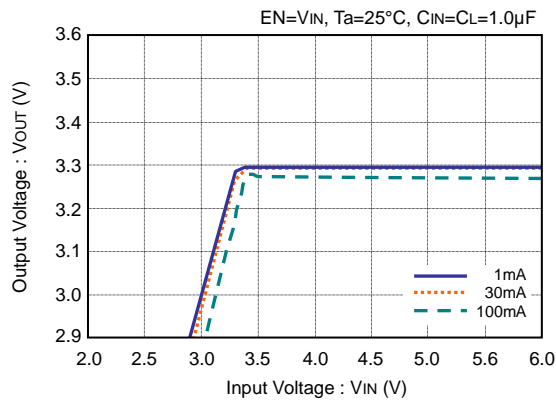

● **VRD (V<sub>OUT</sub>=3.3V)**

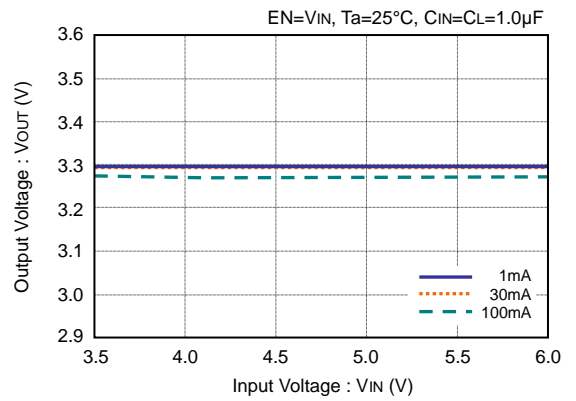

**TYPICAL CHARACTERISTICS – Dropout Voltage vs. Output Current**

● **VRD (V<sub>OUT</sub>=1.5V)**

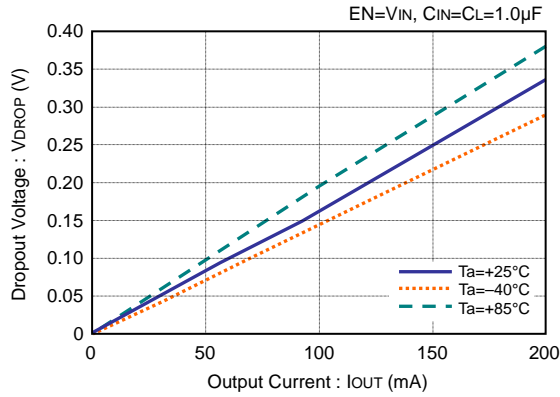

● **VRD (V<sub>OUT</sub>=1.8V)**

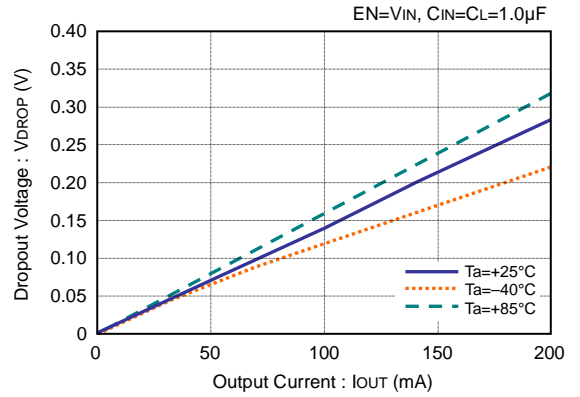

● **VRD (V<sub>OUT</sub>=2.8V)**

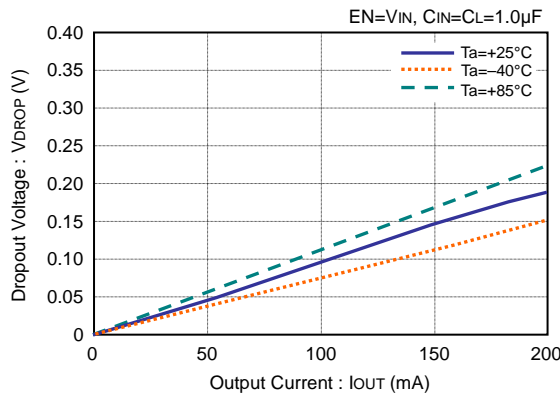

● **VRD (V<sub>OUT</sub>=3.3V)**

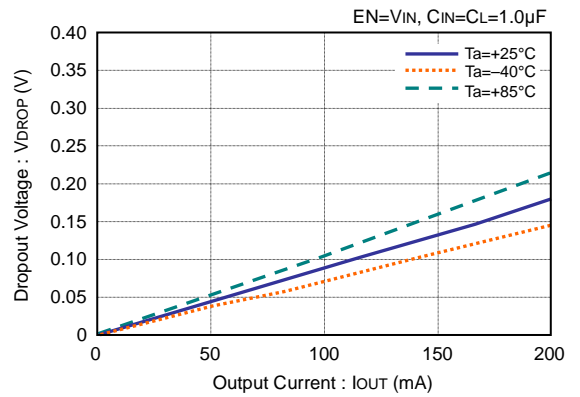

**TYPICAL CHARACTERISTICS – Output Voltage vs. Ambient Temperature**

● **VRD (V<sub>OUT</sub>=1.5V)**

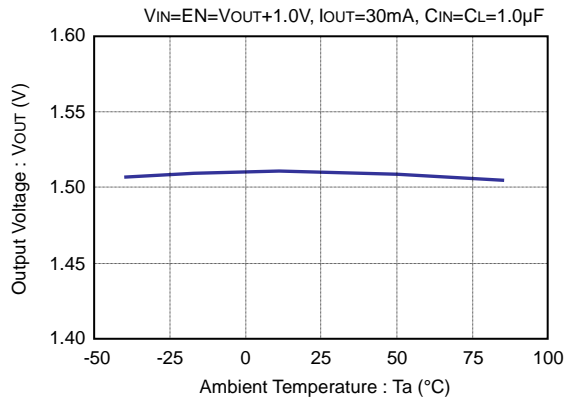

● **VRD (V<sub>OUT</sub>=1.8V)**

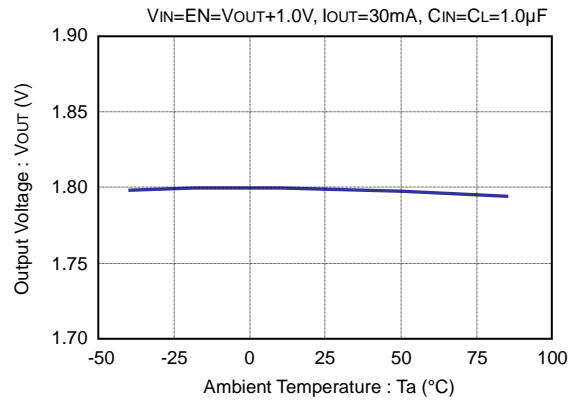

● **VRD (V<sub>OUT</sub>=2.8V)**

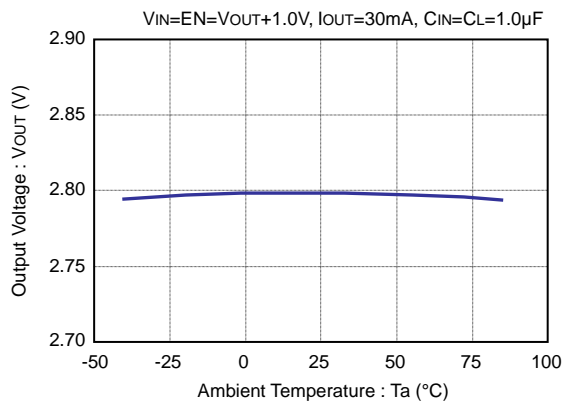

● **VRD (V<sub>OUT</sub>=3.3V)**

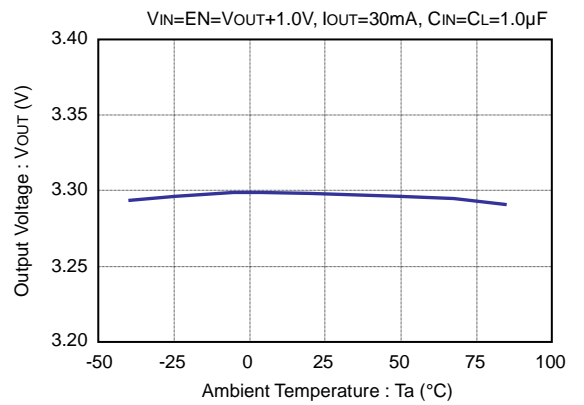



**TYPICAL CHARACTERISTICS – Supply Current vs. Ambient Temperature**

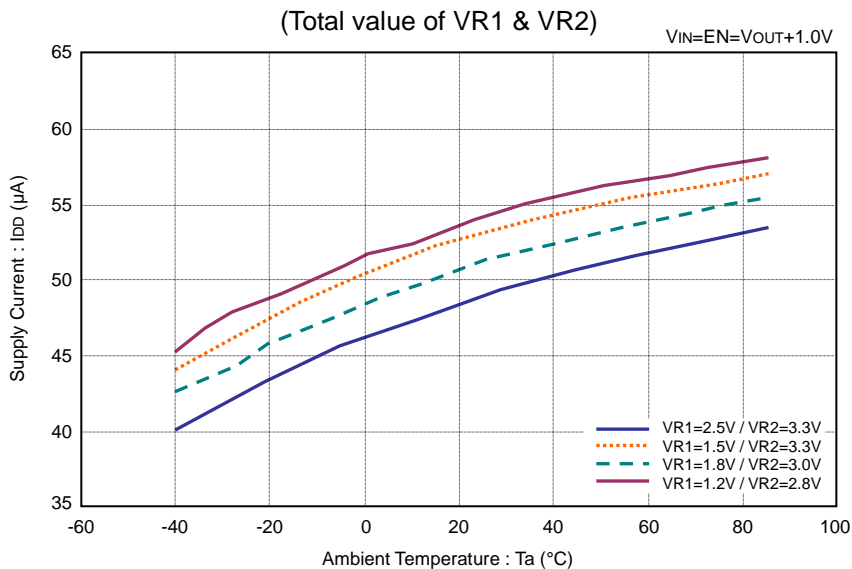

**TYPICAL CHARACTERISTICS – Cross Talk**

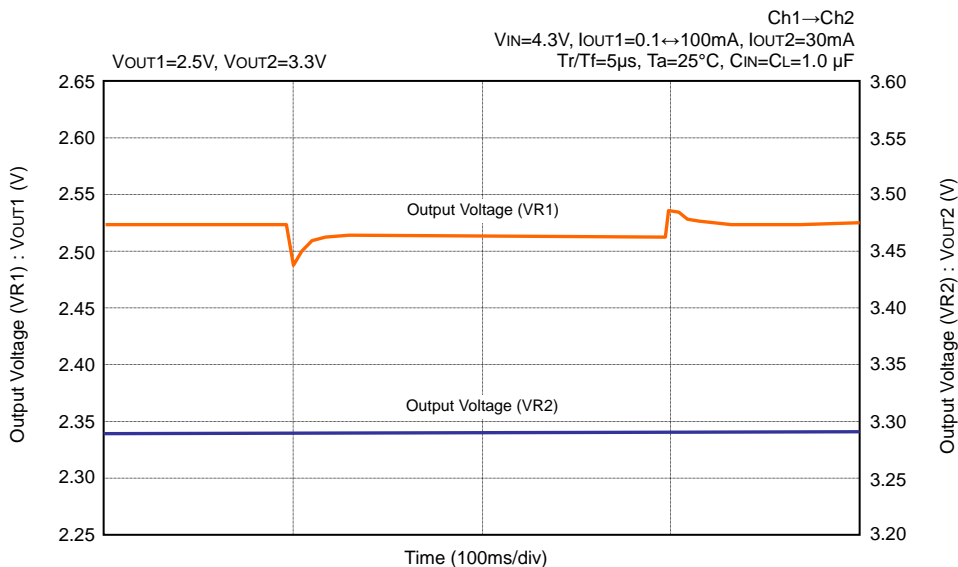

**TYPICAL CHARACTERISTICS – Supply Current vs. Input Voltage**

● **VRD (V<sub>OUT</sub>=1.5V)**

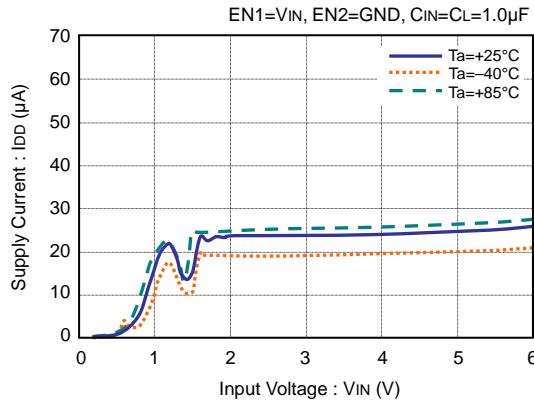

● **VRD (V<sub>OUT</sub>=1.8V)**

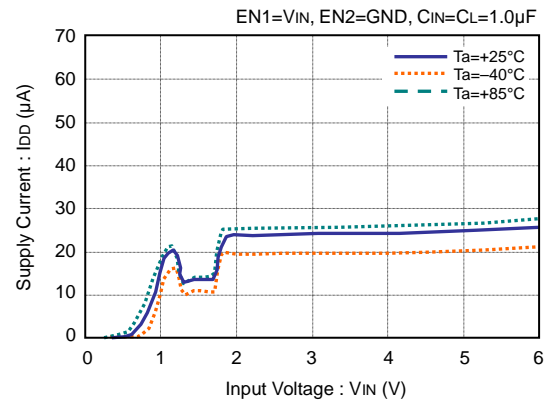

● **VRD (V<sub>OUT</sub>=2.8V)**

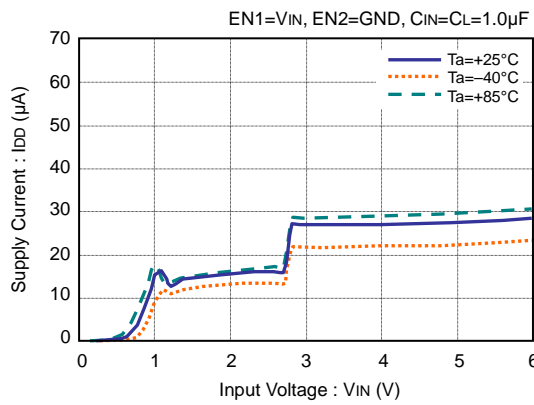

● **VRD (V<sub>OUT</sub>=3.3V)**

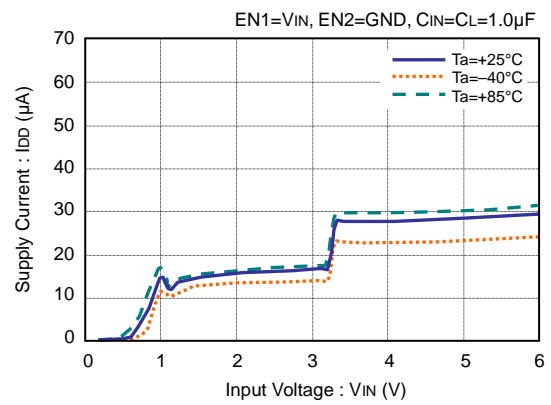

**TYPICAL CHARACTERISTICS – Load Transient Response**

● **VRD (V<sub>OUT</sub>=1.5V)**

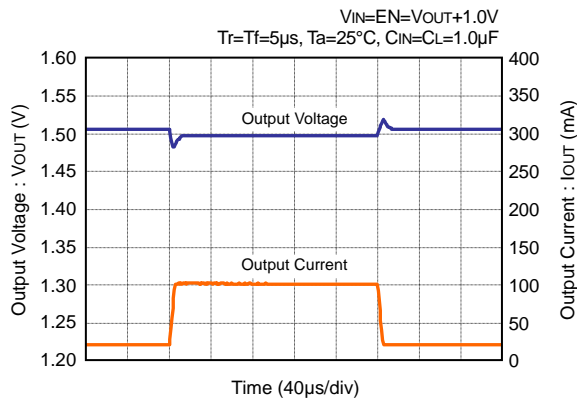

● **VRD (V<sub>OUT</sub>=1.8V)**

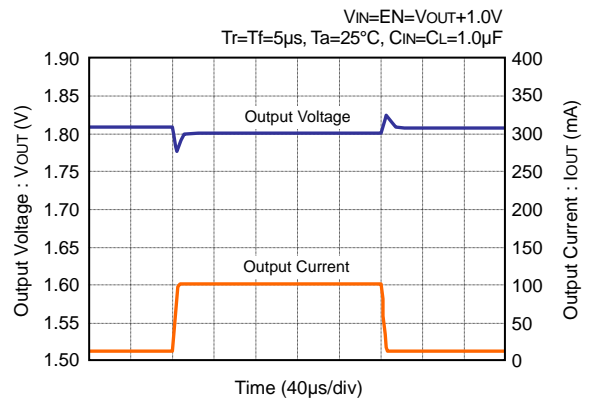

● **VRD (V<sub>OUT</sub>=2.8V)**

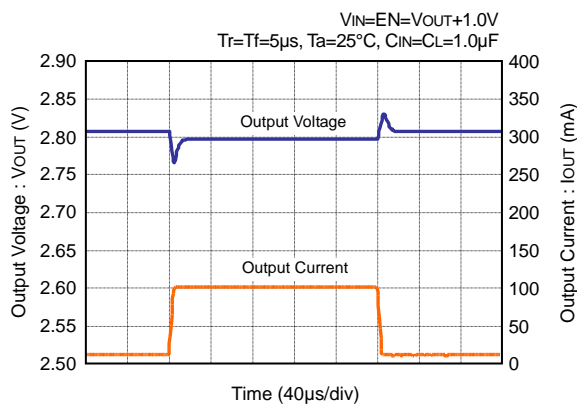

● **VRD (V<sub>OUT</sub>=3.3V)**

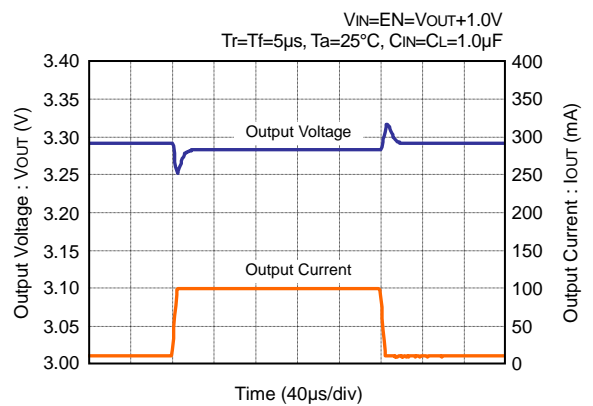

**TYPICAL CHARACTERISTICS – Input Transient Response (I<sub>out</sub>=1mA)**

● **VRD (V<sub>OUT</sub>=1.5V)**

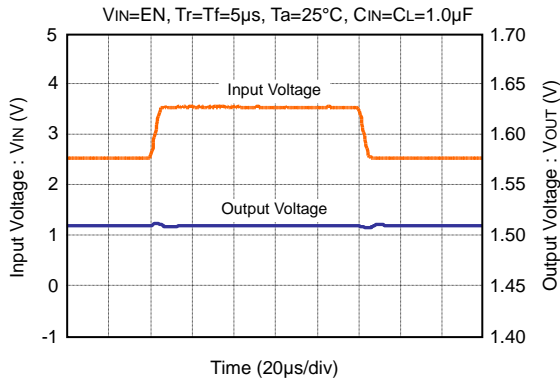

● **VRD (V<sub>OUT</sub>=1.8V)**

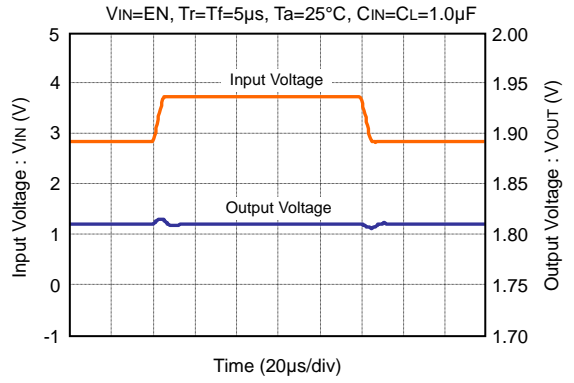

● **VRD (V<sub>OUT</sub>=2.8V)**

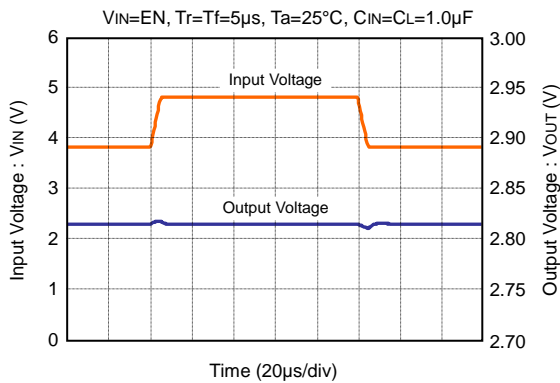

● **VRD (V<sub>OUT</sub>=3.3V)**

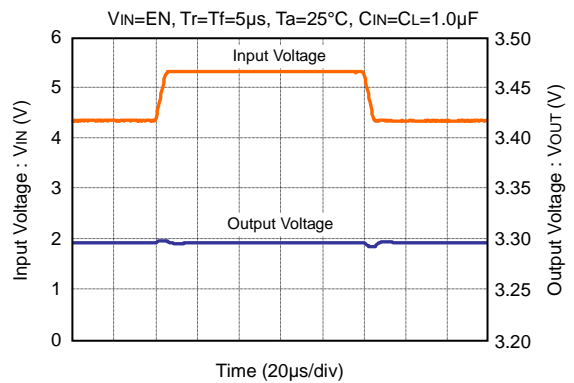

**TYPICAL CHARACTERISTICS – Input Transient Response (Iout=30mA)**

● **VRD (Vout=1.5V)**

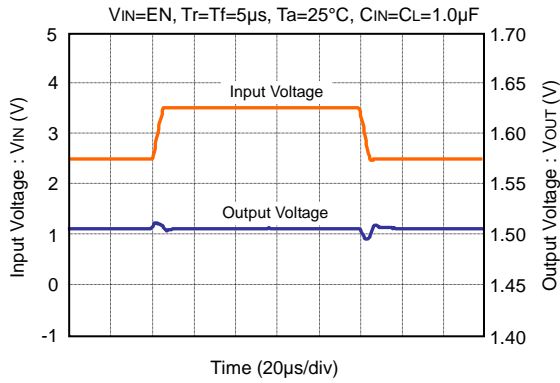

● **VRD (Vout=1.8V)**

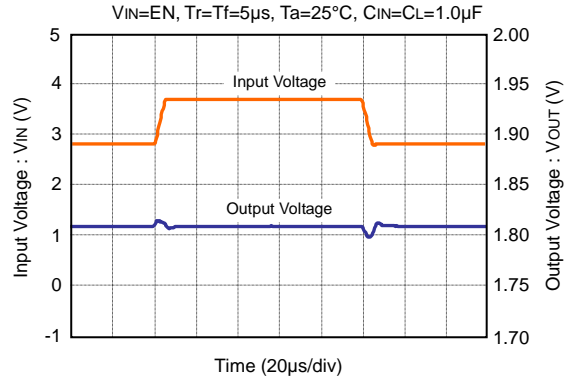

● **VRD (Vout=2.8V)**

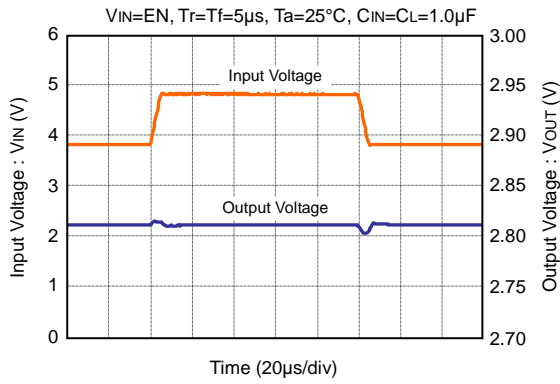

● **VRD (Vout=3.3V)**

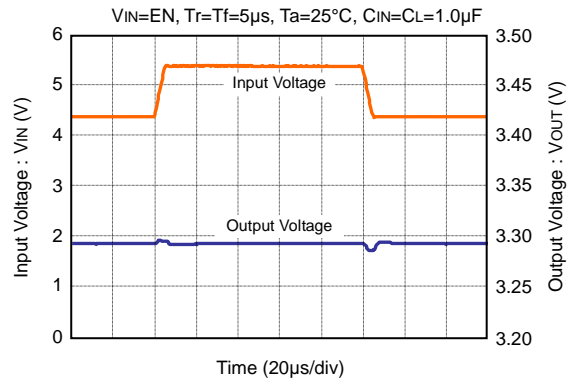

**TYPICAL CHARACTERISTICS – Input Transient Response (I<sub>out</sub>=100mA)**

● **VRD (V<sub>OUT</sub>=1.5V)**

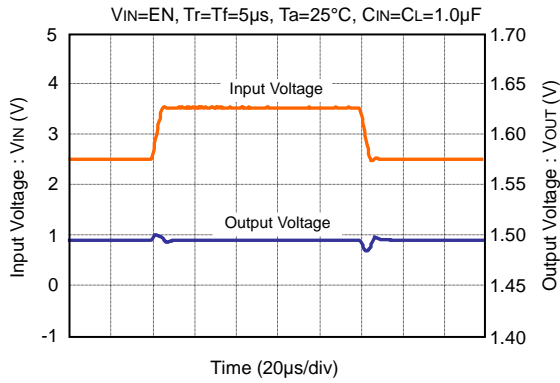

● **VRD (V<sub>OUT</sub>=1.8V)**

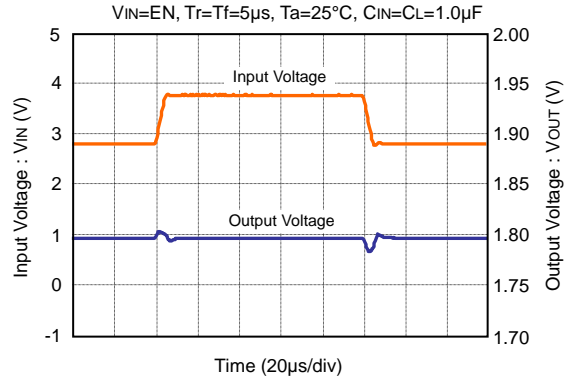

● **VRD (V<sub>OUT</sub>=2.8V)**

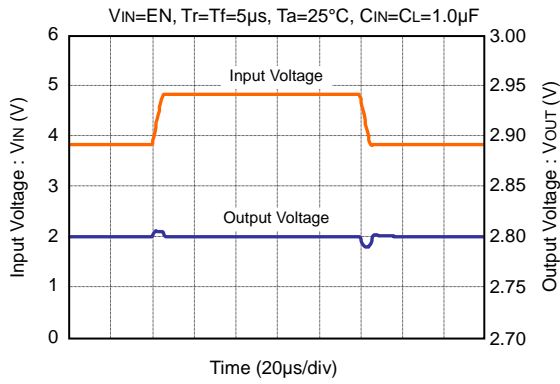

● **VRD (V<sub>OUT</sub>=3.3V)**

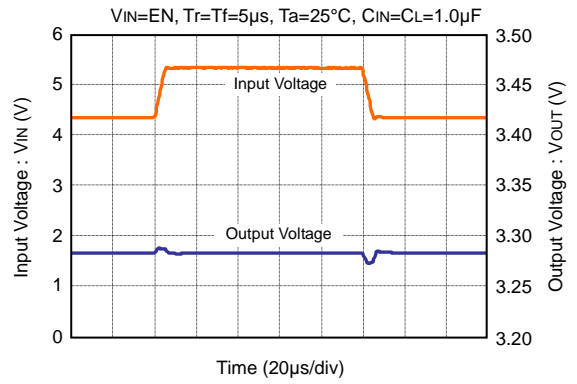

**TYPICAL CHARACTERISTICS – Input Rise Time (Iout=1mA)**

● **VRD (Vout=1.5V)**

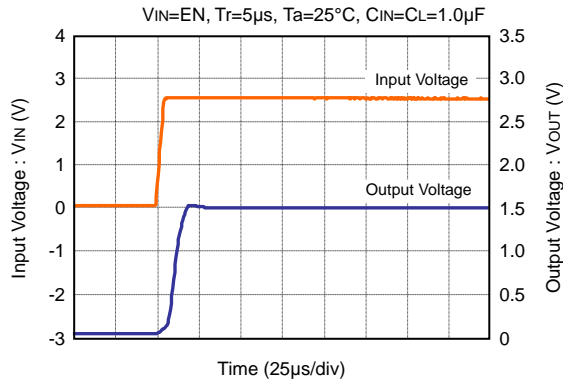

● **VRD (Vout=1.8V)**

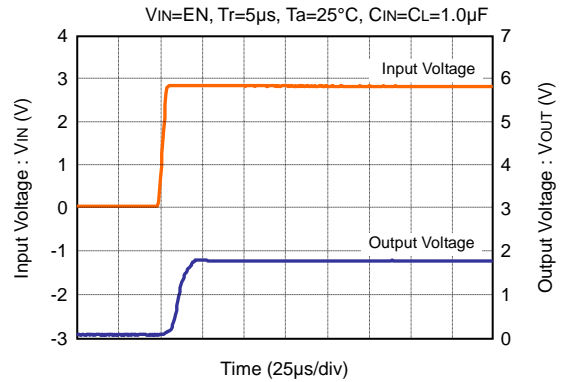

● **VRD (Vout=2.8V)**

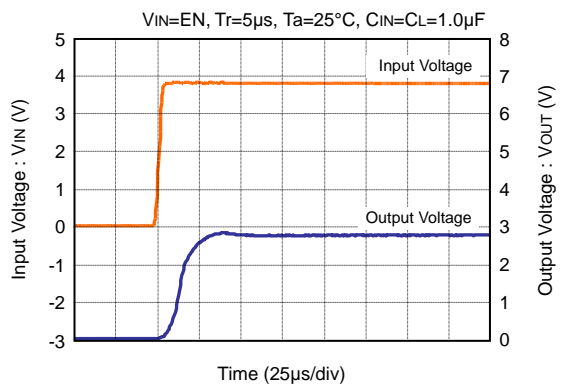

● **VRD (Vout=3.3V)**

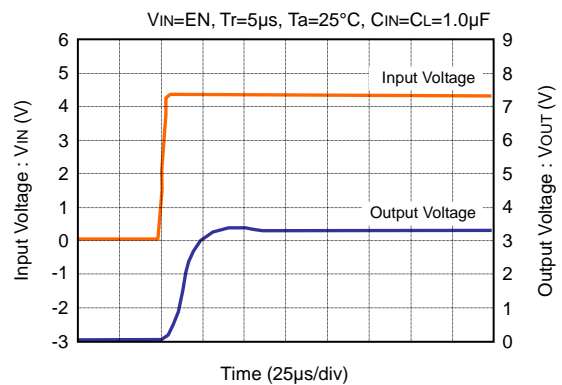

**TYPICAL CHARACTERISTICS – Input Rise Time (Iout=30mA)**

● **VRD (VOUT=1.5V)**

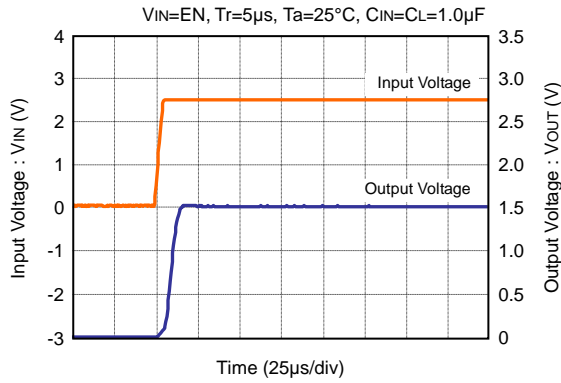

● **VRD (VOUT=1.8V)**

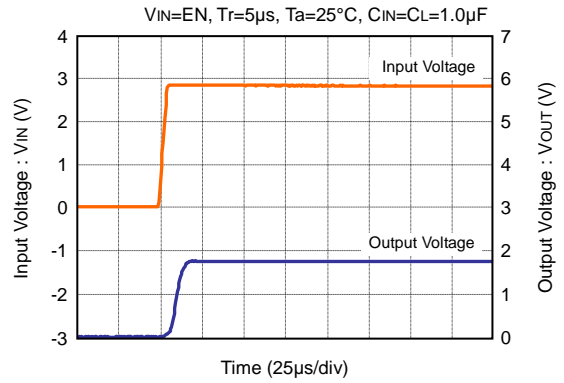

● **VRD (VOUT=2.8V)**

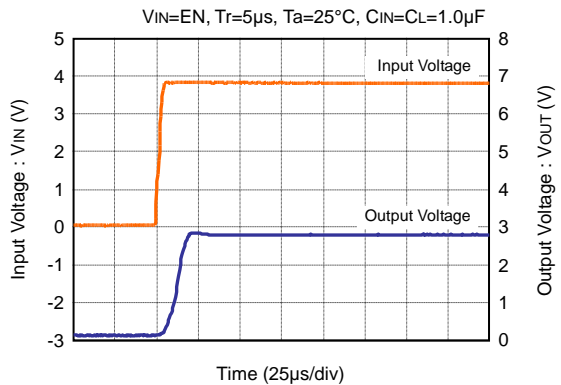

● **VRD (VOUT=3.3V)**

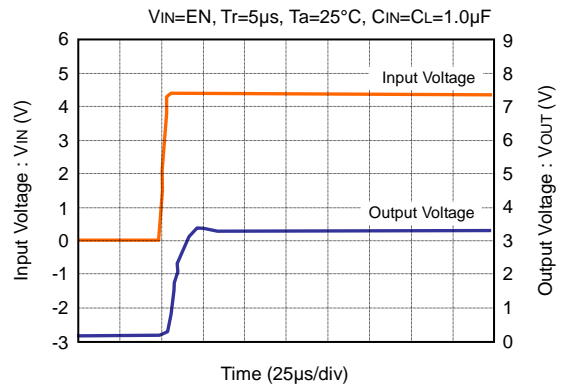



**TYPICAL CHARACTERISTICS – Input Rise Time (Iout=100mA)**

● **VRD (Vout=1.5V)**

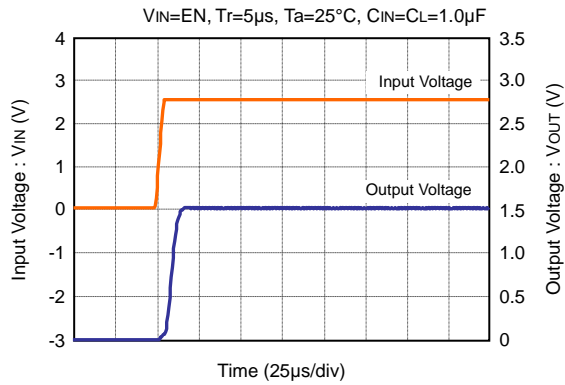

● **VRD (Vout=1.8V)**

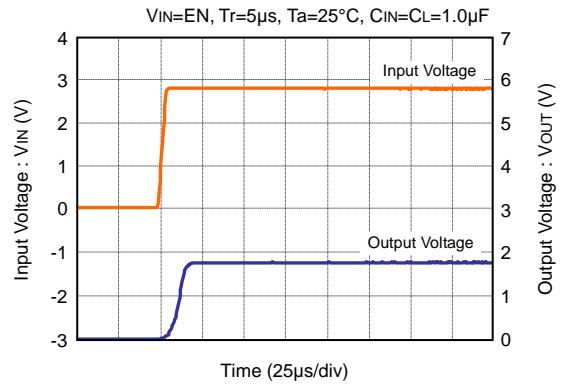

● **VRD (Vout=2.8V)**

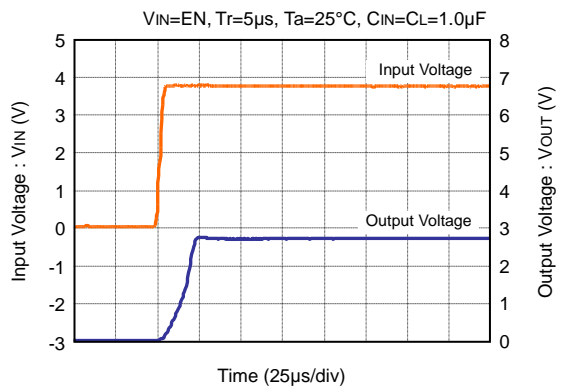

● **VRD (Vout=3.3V)**

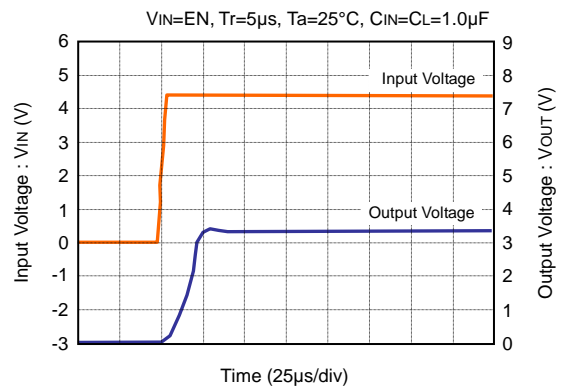

**TYPICAL CHARACTERISTICS – EN Rise Time (I<sub>out</sub>=1mA)**

● **VRD (V<sub>OUT</sub>=1.5V)**

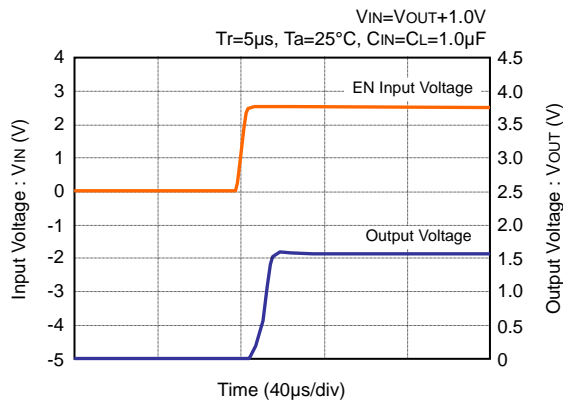

● **VRD (V<sub>OUT</sub>=1.8V)**

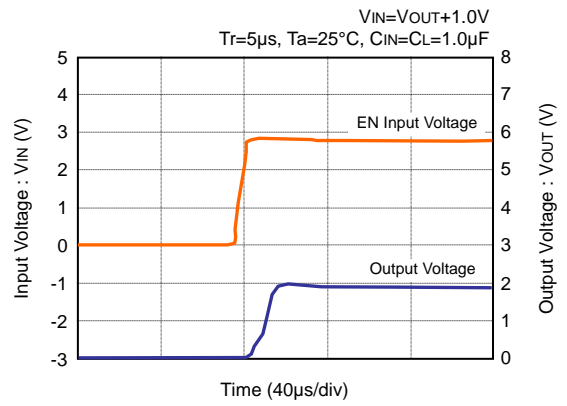

● **VRD (V<sub>OUT</sub>=2.8V)**

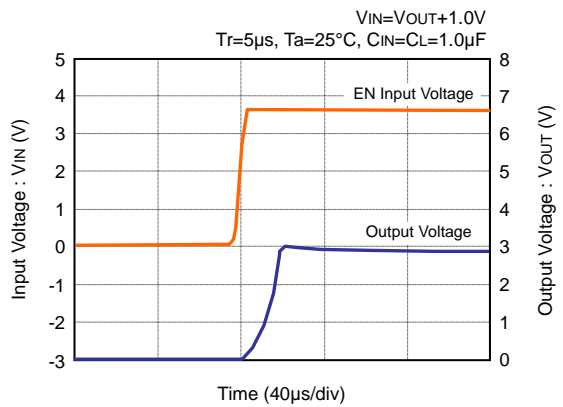

● **VRD (V<sub>OUT</sub>=3.3V)**

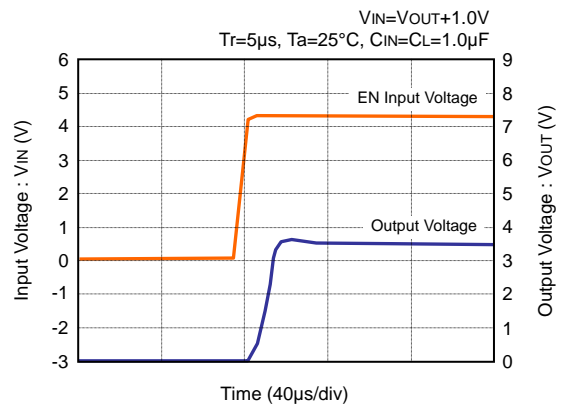

**TYPICAL CHARACTERISTICS – EN Rise Time (Iout=30mA)**

● **VRD (VOUT=1.5V)**

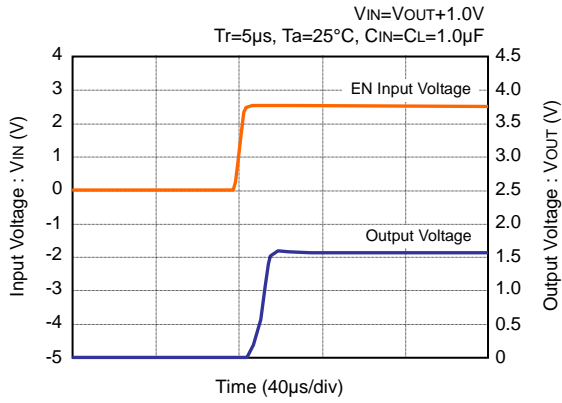

● **VRD (VOUT=1.8V)**

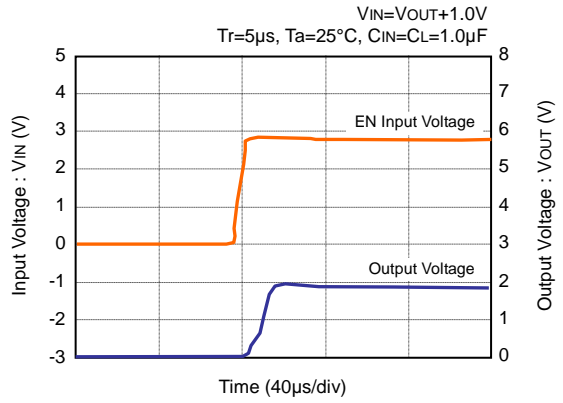

● **VRD (VOUT=2.8V)**

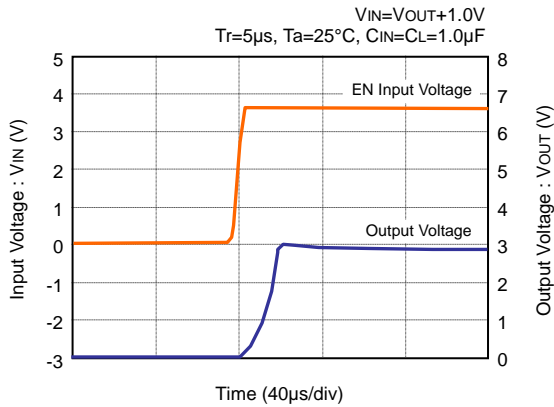

● **VRD (VOUT=3.3V)**

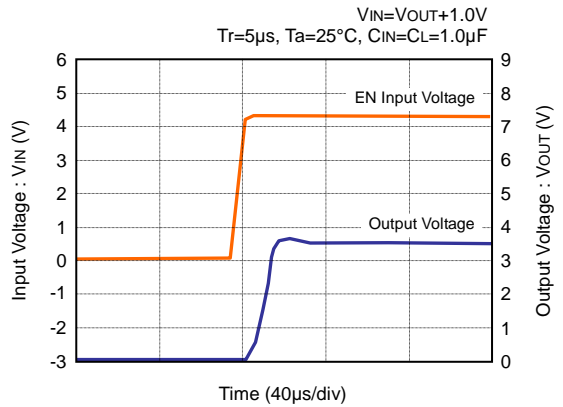

**TYPICAL CHARACTERISTICS – EN Rise Time (Iout=100mA)**

● **VRD (VOUT=1.5V)**

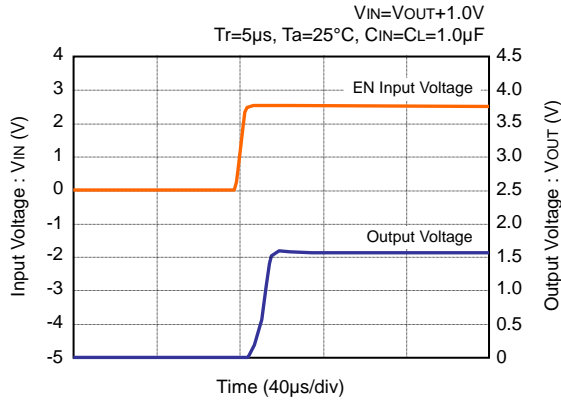

● **VRD (VOUT=1.8V)**

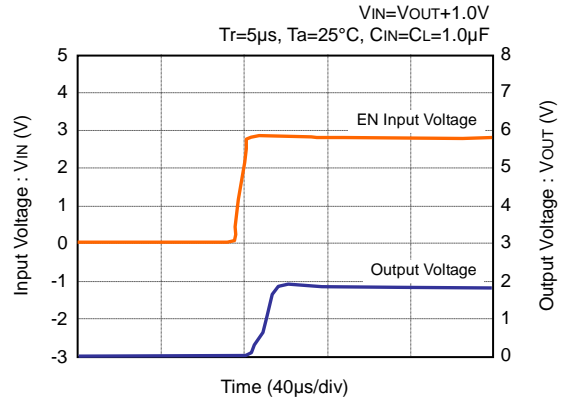

● **VRD (VOUT=2.8V)**

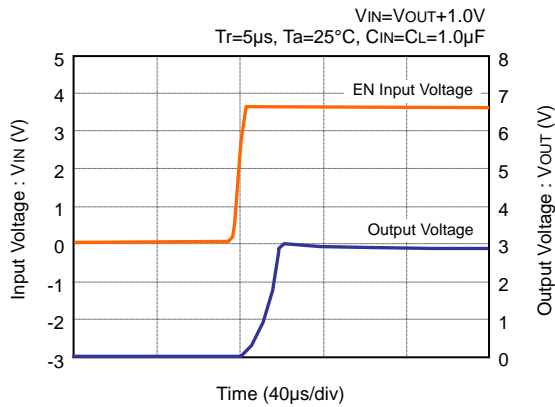

● **VRD (VOUT=3.3V)**

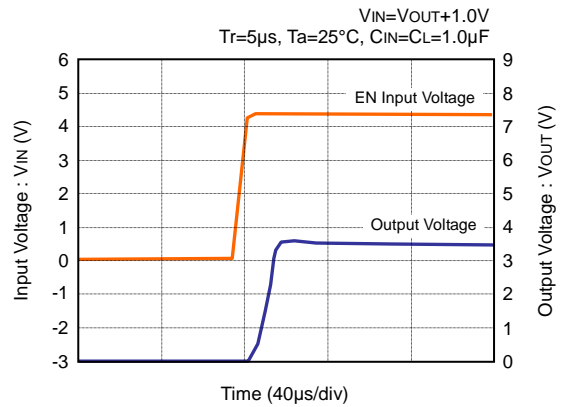

**TYPICAL CHARACTERISTICS – Ripple Rejection Rate**

● **VRD (VOUT=1.5V)**

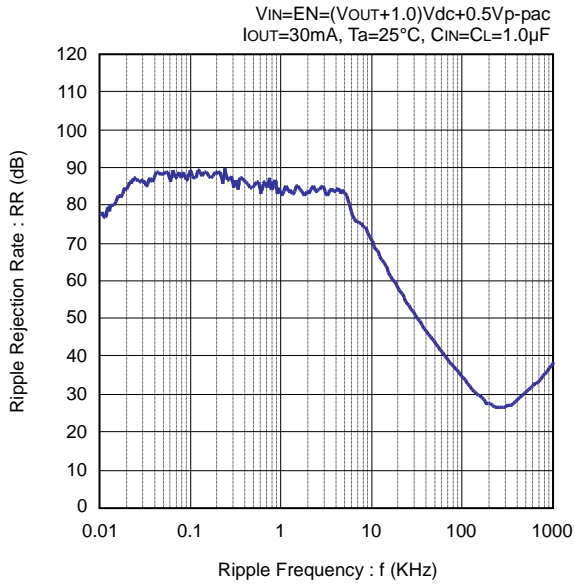

● **VRD (VOUT=1.8V)**

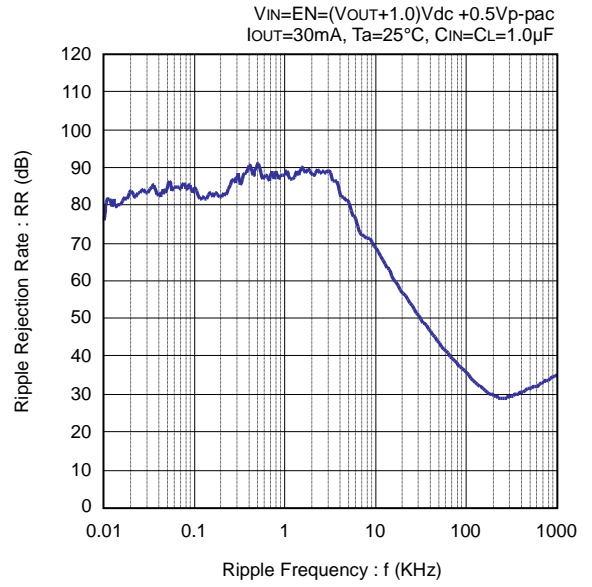

● **VRD (VOUT=2.8V)**

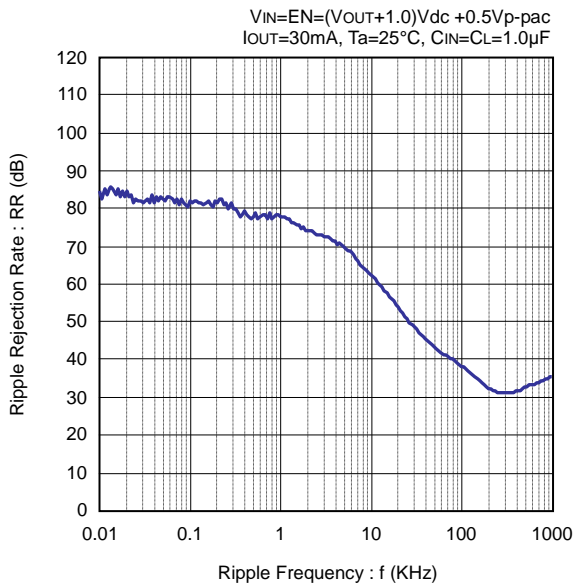

● **VRD (VOUT=3.3V)**

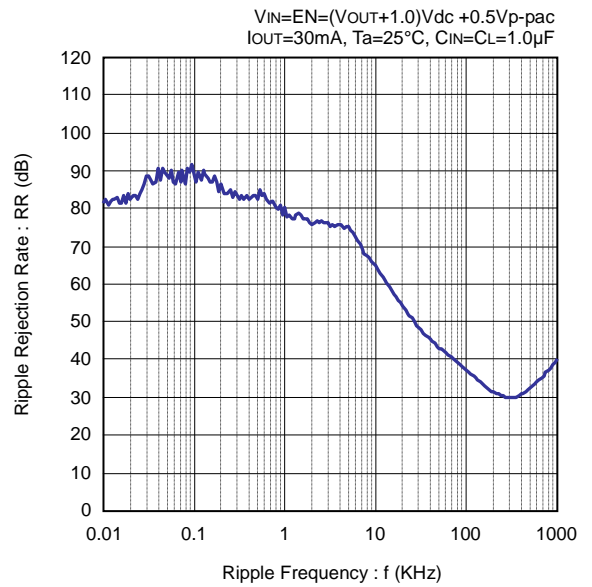



**TAPING AND LOADING SPECIFICATIONS (SOT-26)**

(Unit : mm)

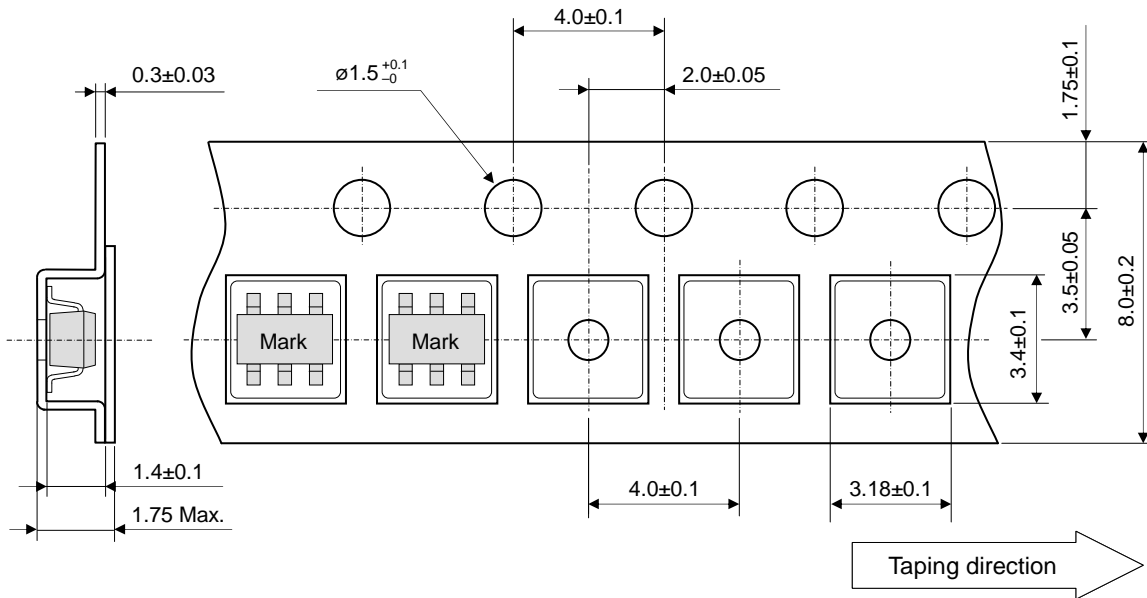

**REEL DIMENSIONS (SOT-26)**

(Unit : mm)

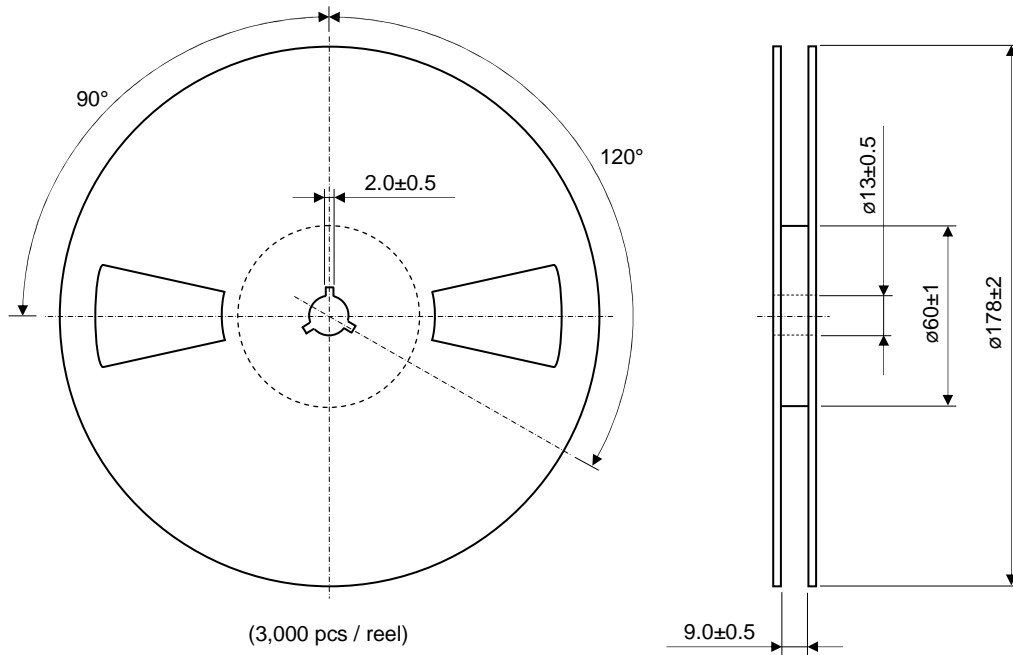

**PACKAGE DIMENSIONS (LLP-6)**

(Unit : mm)

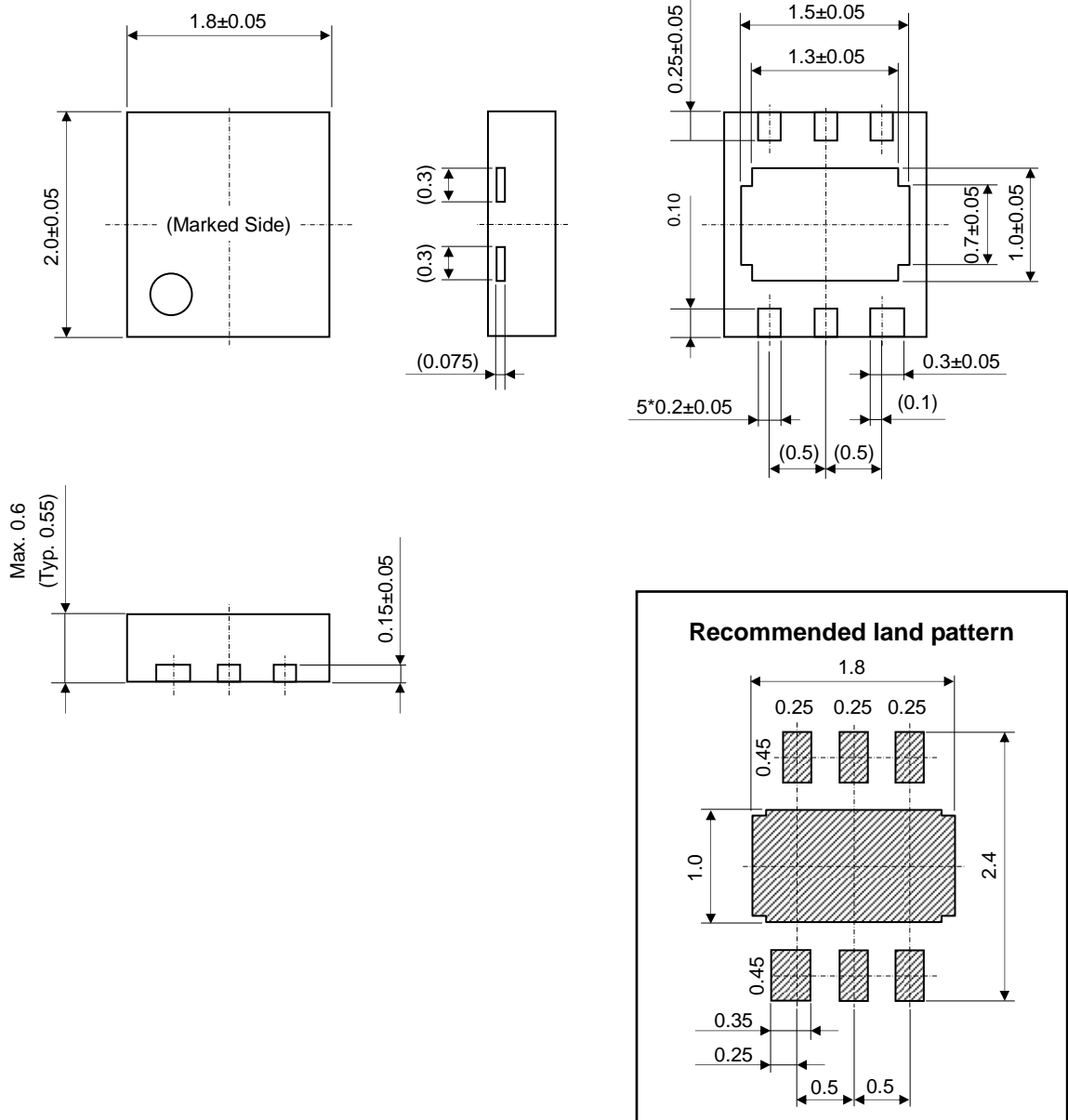



**TAPING AND LOADING SPECIFICATIONS (LLP-6)**

(Unit : mm)

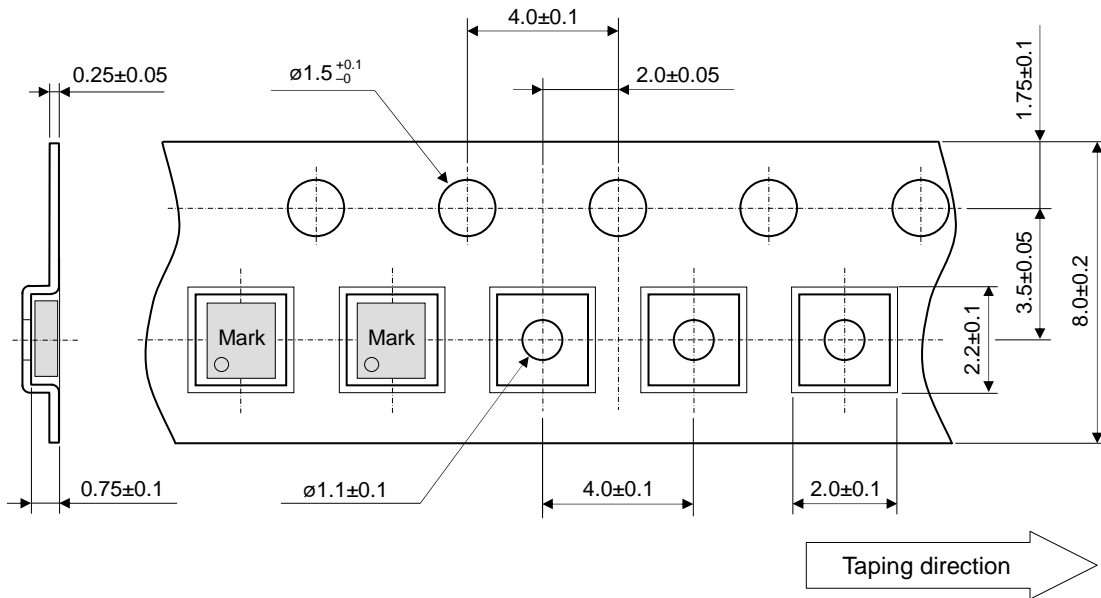

**REEL DIMENSIONS (LLP-6)**

(Unit : mm)

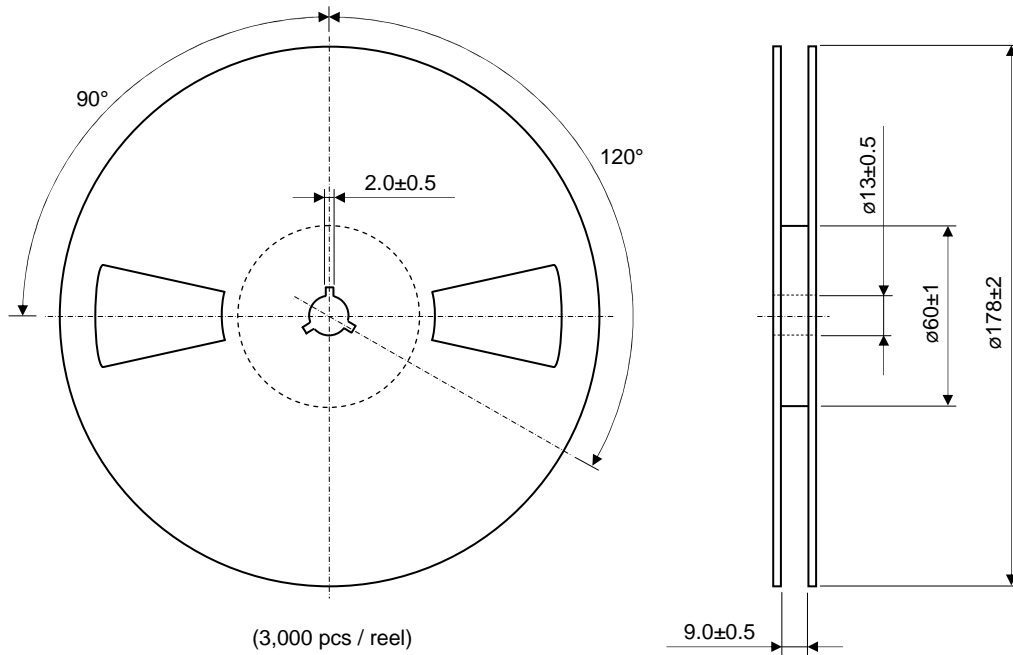

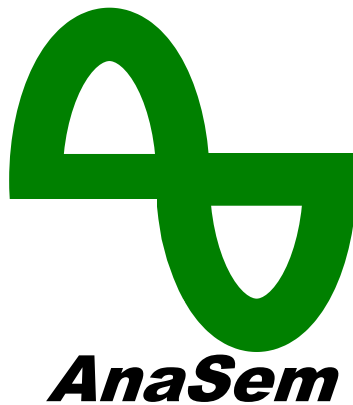

AnaSem may change the products described in this data sheet, or may discontinue production or services without any notice in order to supply the best products through improve the design and performance. Customers are recommended to obtain the latest data or information before placing orders in order to make sure the data or information required is the newest. It is necessary for customers to fully understand the products described in this data sheet and to use it in accordance with its specifications. The products described in this data sheet are not intended to use for the apparatus which have influence on human lives due to the failure or malfunction of the products. AnaSem Corp. is not responsible for any support to customer's application, product design, software performance, patent infringement or service. AnaSem Corp. does not disclose or imply a guarantee or description about being licensed based on patents, copy-rights, circuit location license, or other intellectual properties associated with the devices or combinations in which the products or service of AnaSem Corp. are used or can be used, or which cover the methods. Customers should not export, directly or indirectly, any products without obtaining required licenses and approvals in advance from appropriate government agencies.

**AnaSem**

---

[www.anasemi.com](http://www.anasemi.com)

[sales@anasemi.com](mailto:sales@anasemi.com)

## GENUINE PRODUCT LEGITIMATE LABEL DEFINITION



## X-ON Electronics

Largest Supplier of Electrical and Electronic Components

*Click to view similar products for [anase](#) manufacturer:*

Other Similar products are found below :

[VDA1810NTA](#) [VDA4410NTA](#) [VDA1810CTA](#) [VRH1802LLX](#) [VRH1852LTX](#) [VDA2210CTA](#) [VDA1520NTA](#) [VDA4810NTA](#)  
[VDA1020NTA](#) [VDA4210CTA](#) [VDA3110CTA](#) [VRD3333PTX](#) [VRH3301NVX](#) [VDA2210NTA](#) [VDA2610CTA](#) [VDA5310CTA](#)  
[VDD181MCTA](#) [VDD251LCTA](#) [VDA2810CTA](#) [VDA3110NTA](#) [VDA4110NTA](#) [VDA4710NTA](#) [VDA5510CTA](#) [VDD301MNTA](#)  
[VDA2910NTA](#) [VDA1120NTA](#) [VRH3001NSX](#) [VRD1328MNX](#) [VDA4310NTA](#) [VDA1220NTA](#) [VDA1420NTA](#) [VDD181MNTA](#)  
[VDD261MCTA](#) [VDA0820CTA](#) [VRD1230MTX](#) [VRD1833MLX](#) [VRD3033PTX](#) [VDD261SCTA](#) [VDD281MCTA](#) [VDD291LCTA](#)  
[VDA1120CTA](#) [VDA3210NTA](#) [VDA3810CTA](#) [VRD3232PLX](#) [VRD3233PLX](#) [VRH1202LLX](#) [VRH1802LVX](#) [VRH2601NLX](#)  
[VRH2801NSX](#) [VRH2851NLX](#)