



Analog Semiconductor IC

VRH Series

High speed, Low dropout, $\pm 1\%$ High output accuracy
CMOS Voltage Regulator with On/Off circuit

(IMPORTANT: Please check the last page for Genuine Product Labeling)

Rev. E13-01

Website: www.anasemi.com
Tel: +852-3590-8442
Email: sales@anasemi.com

AnaSem
..... Future of the analog world



AnaSem

Products Data Sheet

Analog Semiconductor IC

High speed, Low dropout, $\pm 1\%$ High output accuracy with On/Off circuit CMOS Voltage Regulator

VRH Series

GENERAL DESCRIPTIONS

The VRH series are positive voltage regulators with high speed, low voltage dropout and high accuracy output achieved by low current consumption. The output voltage is guaranteed within $\pm 1\%$ within the given temperature range by Vref controlling the temperature characteristic. It corresponds to the low ESR capacitor as an output stabilization capacitor. The charged ESR capacitor can be discharged with an internal switch by making the EN=Vss, as a result the VOUT quickly returns to the Vss level. To make the current capacity of the output transistor not exceeded, the over-current protection circuit is built in.

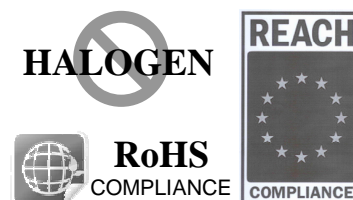

FEATURES

- Output voltage range 0.9V~5.0V (selectable with a step of 0.05V)
- Operating voltage range 1.6V~6.0V
- High accuracy output voltage $\pm 1\%$ (VOUT=1.95V ~ 5.0V) / $\pm 20\text{mV}$ (VOUT=0.9V ~ 1.9V)
- Maximum output current 250mA
- Dropout voltage Typ. 90mV (output=3.0V, IOUT=100mA)
- Low current consumption Typ. 25 μA
- High ripple rejection Typ. 75dB at 1KHz
- Low ESR capacitor 1.0 μF ceramic capacitor
- Operating temperature range -40°C ~ $+85^{\circ}\text{C}$
- Built-in over-current protector Limit current : 300mA
- CL high-speed auto-discharge
- Built-in On/Off circuit
- Small package SOT-25 (2.9 \times 2.8 \times 1.1mm), LLP-4 (1.2 \times 1.6 \times 0.6mm), SDFN-4 (1.0 \times 1.0 \times 0.4mm),

APPLICATIONS

- Battery powered devices
- Cellular phone
- Digital / Video cameras
- Portable games
- Handheld instruments

PRODUCTS NUMBERING GUIDE

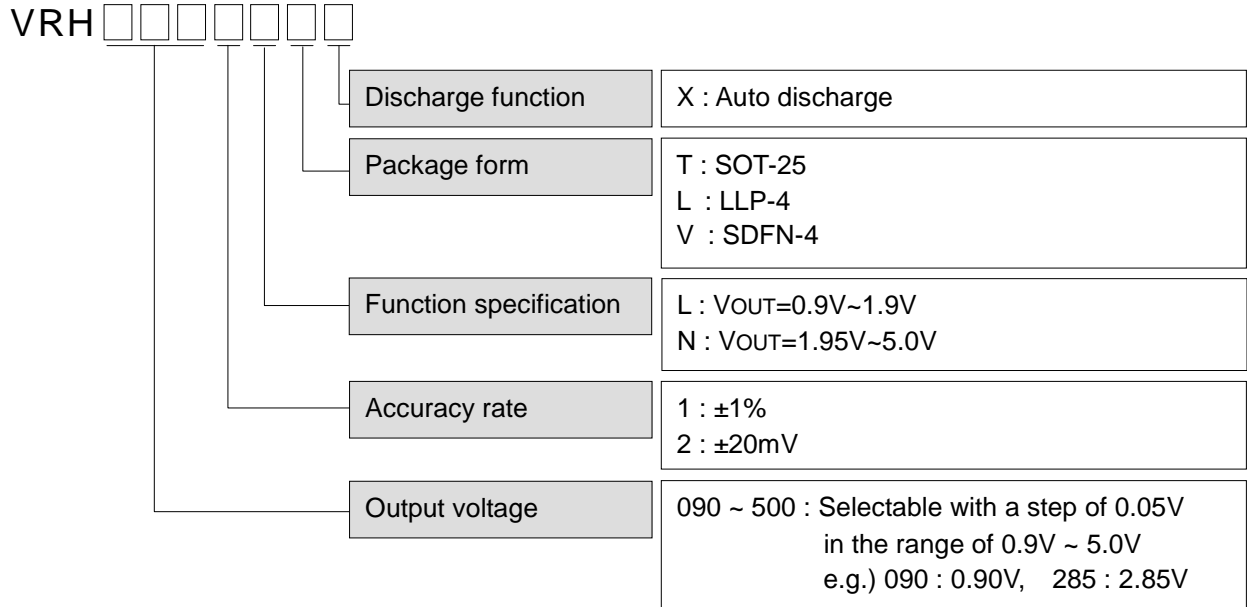

PIN CONFIGURATION / MARKING SPECIFICATION (SOT-25)

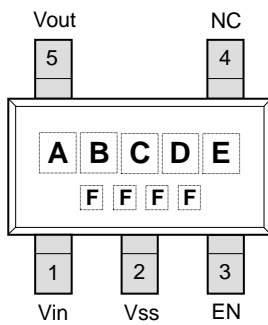

(Top view)

● **Pin Configuration**

No.	Symbol	Descriptions
1	VIN	Voltage input
2	VSS	Power ground
3	EN	Chip enable
4	NC	Non connection (open)
5	VOUT	Output

● **Marking Specification**

Code	Mark	Contents
A	H	Products series name
BCD	090~500	Output voltage
E	X	Discharge function
F	Internal rule	Lot number

PIN CONFIGURATION / MARKING SPECIFICATION (LLP-4)

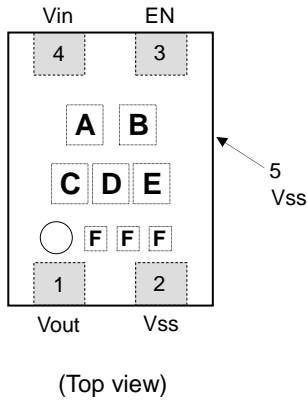

● **Pin Configuration**

No.	Symbol	Descriptions
1	VOUT	Output
2	VSS	Power ground
3	EN	Chip enable
4	VIN	Voltage input
5	VSS	Power ground

● **Marking Specification**

Code	Mark	Contents
A	H	Products series name
B	X	Discharge function
CDE	090~500	Output voltage
F	Internal rule	Lot number

PIN CONFIGURATION / MARKING SPECIFICATION (SDFN-4)

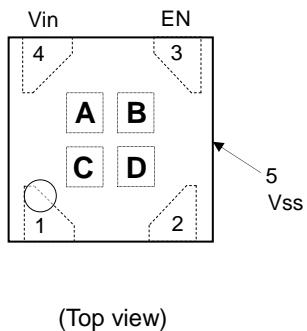

● **Pin Configuration**

No.	Symbol	Descriptions
1	VOUT	Output
2	VSS	Power ground
3	EN	Chip enable
4	VIN	Voltage input
5	VSS	Power ground

● **Marking Specification**

Code	Mark	Contents
AB	09~50	Output voltage
CD	Internal rule	Lot number

BLOCK DIAGRAM

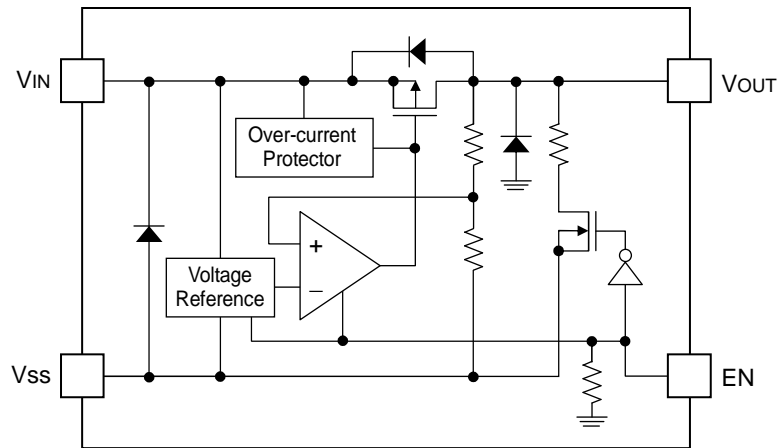

ABSOLUTE MAXIMUM RATINGS

Items	Symbol	Ratings	Unit	
Input voltage range	VIN	-0.3 ~ +7.0	V	
Output current	IOUT	500	mA	
Output voltage range	VOUT	VSS -0.3 ~ VIN +0.3	V	
Power dissipation ※1)	SOT-25	PD	600	mW
	LLP-4	PD	1000	mW
	SDFN-4	PD	550	mW
Operating temperature range	TOPR	-40 ~ +85	°C	
Storage temperature range	TSTG	-55 ~ +125	°C	

Note :

- ※1) Power dissipation depends on conditions of mounting on boards.
PCB dimension is 50mm×50mm×1.6mm.

TYPICAL APPLICATION CIRCUITS

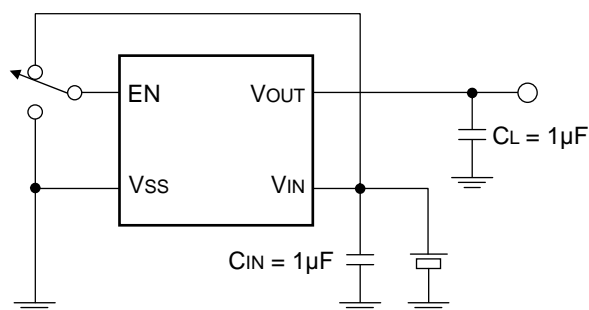

ELECTRICAL CHARACTERISTICS

(Ta=25°C unless otherwise specified)

Items	Symbol	Conditions	Min.	Typ.	Max.	Unit	Test circuit	
Output voltage	V _{OUT}	V _{OUT} +1.0V ≤ V _{IN} ≤ 6.0V I _{OUT} =30mA Ta=-40°C ~ +85°C	V _{OUT} ≥ 1.95V	V _{OUT} x0.99	V _{OUT}	V _{OUT} x1.01	V	1
			V _{OUT} ≤ 1.90V	-20	-	+20	mV	
Output current	I _{OUT}	V _{IN} ≥ V _{OUT} +1.0V	1.2V ≤ V _{OUT} ≤ 1.65V	-	250	-	mA	1
			1.7V ≤ V _{OUT} ≤ 2.25V	-	250	-	mA	
			2.3V ≤ V _{OUT} ≤ 2.85V	-	250	-	mA	
			2.9V ≤ V _{OUT} ≤ 3.45V	-	250	-	mA	
			3.5V ≤ V _{OUT} ≤ 4.05V	-	250	-	mA	
			4.0V ≤ V _{OUT} ≤ 5.00V	-	250	-	mA	
Dropout voltage	V _{DROP}	I _{OUT} =100mA	1.2V ≤ V _{OUT} ≤ 1.65V	-	210	340	mV	1
			1.7V ≤ V _{OUT} ≤ 2.25V	-	130	205	mV	
			2.3V ≤ V _{OUT} ≤ 2.85V	-	100	150	mV	
			2.9V ≤ V _{OUT} ≤ 3.45V	-	90	137	mV	
			3.5V ≤ V _{OUT} ≤ 4.05V	-	85	125	mV	
			4.1V ≤ V _{OUT} ≤ 5.00V	-	80	115	mV	

ELECTRICAL CHARACTERISTICS (continued)

(Ta=25°C unless otherwise specified)

Items	Symbol	Conditions	Min.	Typ.	Max.	Unit	Test circuit
Current consumption	I _{DD}	V _{IN} =V _{OUT} +1.0V, V _{OUT} =Open, I _{OUT} =0mA	-	25	40	μ A	2
Standby current	I _{STB}	EN=V _{SS}	-	0.01	0.1	μ A	2
Input voltage	V _{IN}		1.6	-	6.0	V	1
Load regulation	Δ V _{OUT}	V _{IN} =V _{OUT} +1.0V, I _{OUT} =0.1mA ~ 100mA	-	10	40	mV	1
Line regulation	$\frac{\Delta V_{OUT}}{\Delta V_{IN} \cdot V_{OUT}}$	V _{OUT} +1.0V \leq V _{IN} \leq 6.0V, I _{OUT} =30mA	-	0.01	0.1	%/V	1
Ripple rejection	R _r	V _{IN} =V _{OUT} +1.0V, f=1KHz, Δ V _{RIP} =0.5VP-P, I _{OUT} =30mA	-	75	-	dB	3
Limit current	I _{LIMIT}	EN=V _{IN}	300	-	-	mA	1
Short circuit current	I _{SHORT}	V _{IN} =V _{OUT} +1.0V, V _{OUT} =0V	-	40	-	mA	1
Output voltage temperature coefficient	$\frac{\Delta V_{OUT}}{\Delta T_a \cdot V_{OUT}}$	V _{EN} =V _{IN} , I _{OUT} =300mA Ta=-40°C ~ +85°C		± 20		ppm/ °C	1
EN high level voltage	V _{ENH}		1.2	-	6.0	V	4
EN low level voltage	V _{ENL}		-	-	0.3	V	4
EN high level current	I _{ENH}	V _{EN} = V _{IN} =5V	0.25	-	5.0	μ A	4
EN low level current	I _{ENL}	V _{EN} = V _{SS}	-0.1	-	0.1	μ A	4
CL auto-discharge resistance	R _{DIS}	V _{IN} =6.0V, V _{OUT} =4.0V, V _{EN} = V _{SS}	-	160	-	Ω	1

TEST CIRCUITS

- **Circuit (1)** - Output voltage, Output current, Dropout voltage, Input voltage, Load regulation, Line regulation, Limit current, Short circuit current, Output voltage temperature coefficient, CL auto-discharge resistance

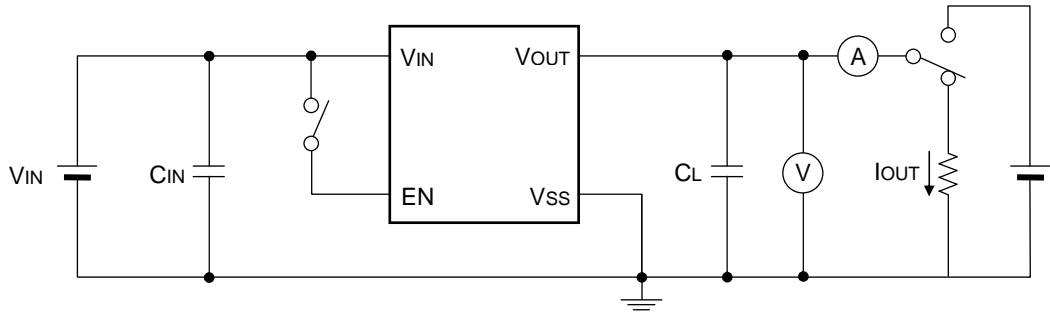

- **Circuit (2)** - Current consumption, Standby current

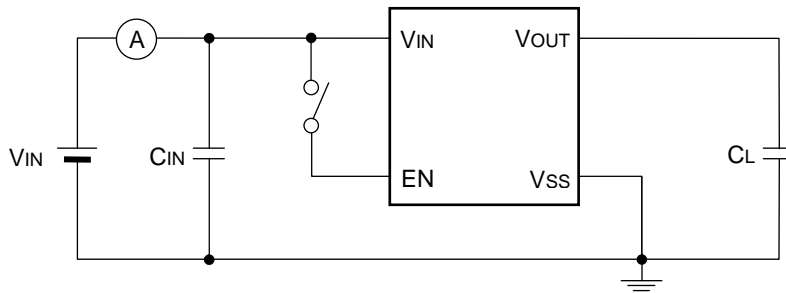

- **Circuit (3)** - Ripple rejection

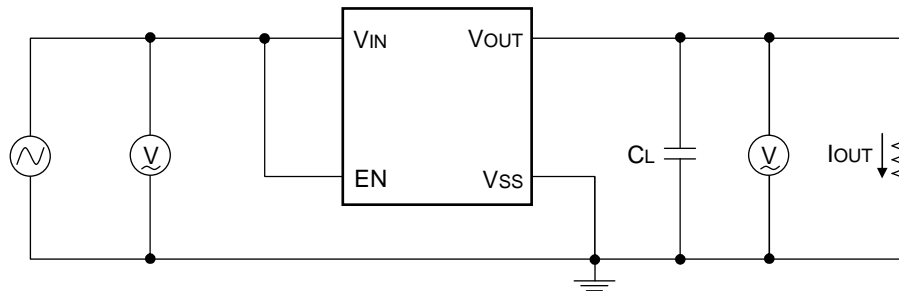

- **Circuit (4)** - EN high level voltage, EN low level voltage, EN high level current, EN low level current

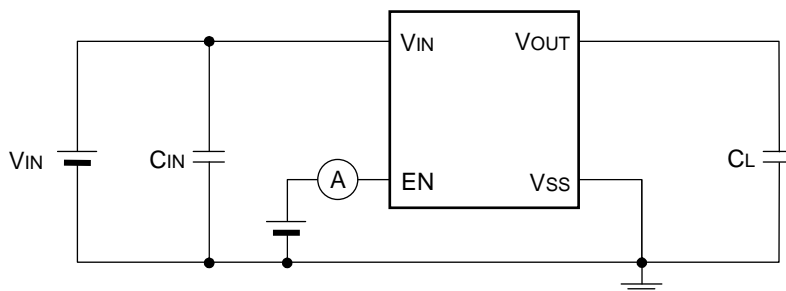

DESCRIPTION OF OPERATION

● General operation

In reference to following block diagram of the VRH series ;

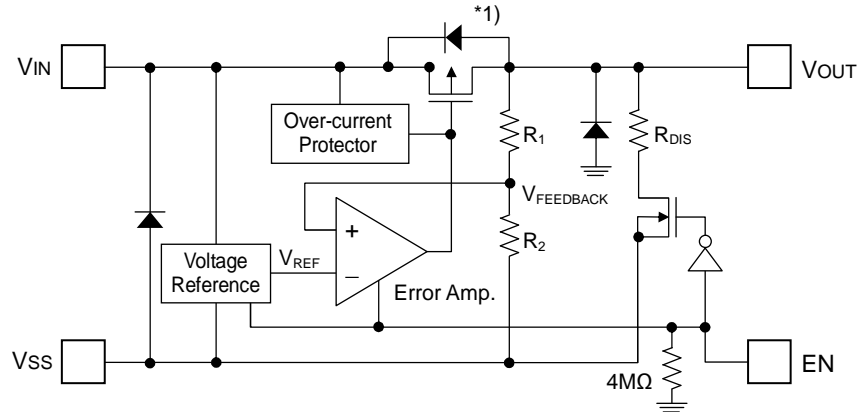

By the error amplifier, the reference voltage (V_{REF}) is compared with $V_{FEEDBACK}$ which is divided by feedback resistors R_1 and R_2 . It supplies the output transistor (see note *1) to keep a stabilized output voltage against with any fluctuation of input voltage by negative feedback system.

Note *1)

The VRH series has P-channel MOSFET which is connected to the VOUT terminal as the output transistor. To prevent the VRH series from being damaged due to inverse current from VOUT terminal to VIN terminal through a parasitic diode, VOUT should not be exceeded $V_{IN}+0.3V$.

● EN terminal (shutdown function) & CL auto-discharge

The VRH series can be shutdown through EN terminal. The P-channel MOSFET is turned off and operation of all internal circuits stops to reduce the current consumption when the signal of EN terminal is set to the shutdown level. In shutdown mode, the VRH series enables the electric charge at the CL to be discharged via the auto-discharge resistance (R_{DIS} ; 160 Ω), and the VOUT terminal can be rapidly returned to the VSS level as a result.

● Output capacitor (CL)

For phase compensation, an output capacitor (C_L) is required to connected between VOUT terminal and VSS terminal as close as possible. A ceramic capacitor with capacitance value of at least 1.0 μF is recommended. Of course, the suitable capacitance value should be different by the condition of each application. In addition, an input capacitor (C_{IN}) with capacitance value of at least 1.0 μF is also recommended between VIN terminal and VSS terminal for stable input power.

● Over current protection and short circuit protection

Built-in over current protection circuit performs circuit protection from over current as a current limiter. When the load current reaches the limit level, the output voltage drops and output current also decreases accordingly. A current of typ. 40mA will flow when output terminal is shorted.

TYPICAL CHARACTERISTICS – Output Voltage vs. Output Current

● **VRH1202xxx (VOUT=1.2V)**

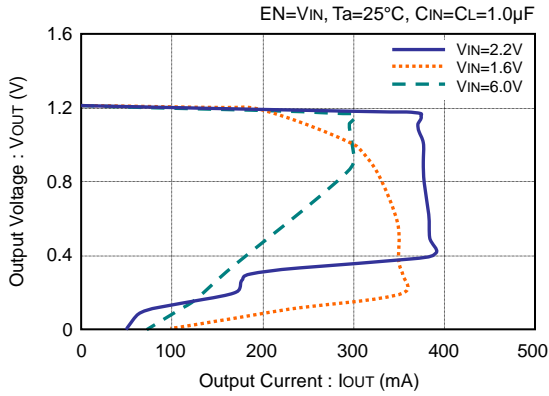

● **VRH1202xxx (VOUT=1.2V)**

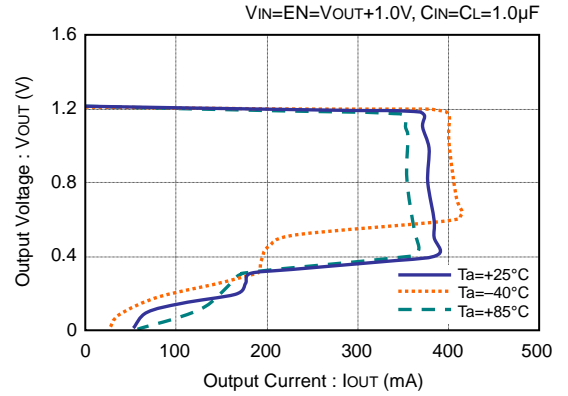

● **VRH1802xxx (VOUT=1.8V)**

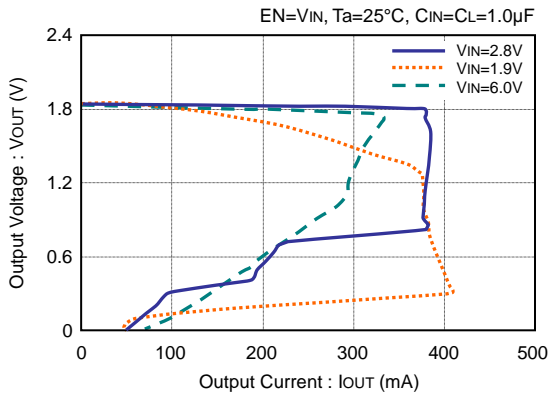

● **VRH1802xxx (VOUT=1.8V)**

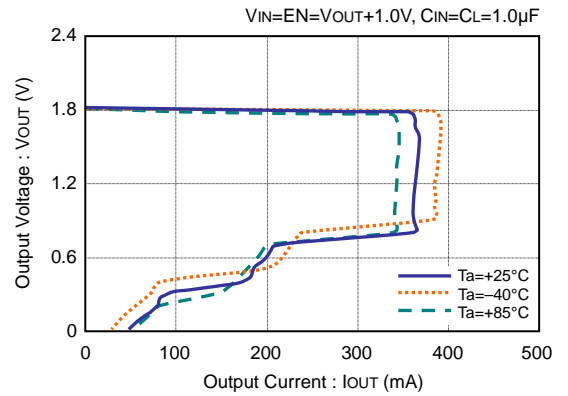

● **VRH2801xxx (VOUT=2.8V)**

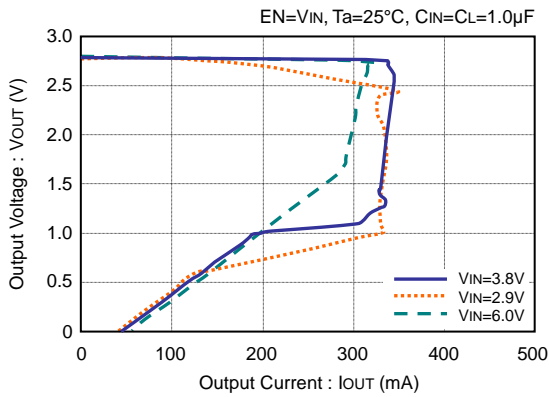

● **VRH2801xxx (VOUT=2.8V)**

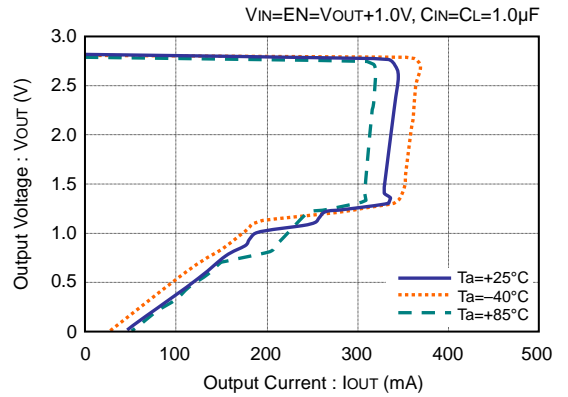

TYPICAL CHARACTERISTICS – Output Voltage vs. Output Current (continued)

● **VRH3001xxx (V_{OUT}=3.0V)**

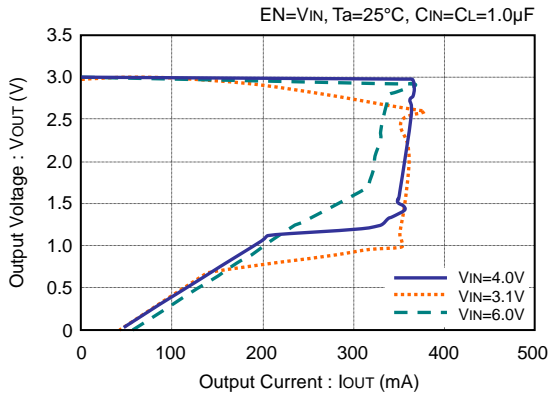

● **VRH3001xxx (V_{OUT}=3.0V)**

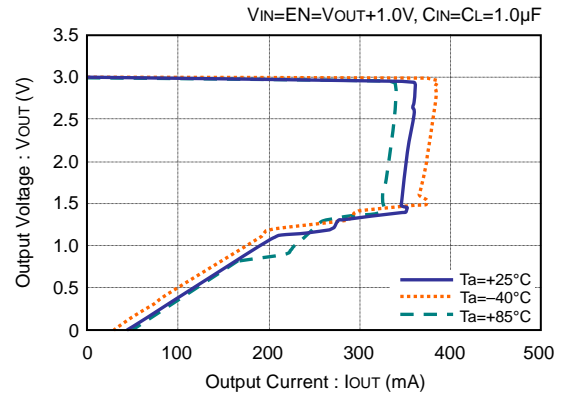

● **VRH3301xxx (V_{OUT}=3.3V)**

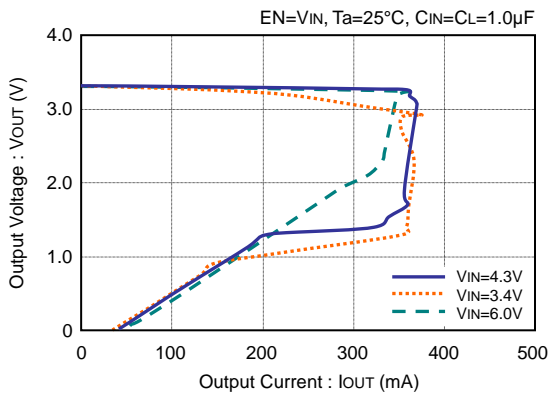

● **VRH3301xxx (V_{OUT}=3.3V)**

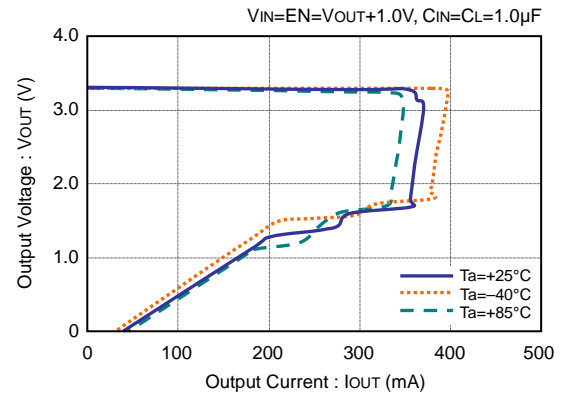

TYPICAL CHARACTERISTICS – Output Voltage vs. Input Voltage

● **VRH1202xxx (VOUT=1.2V)**

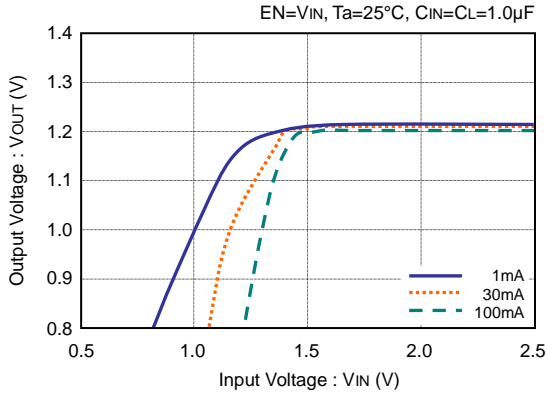

● **VRH1202xxx (VOUT=1.2V)**

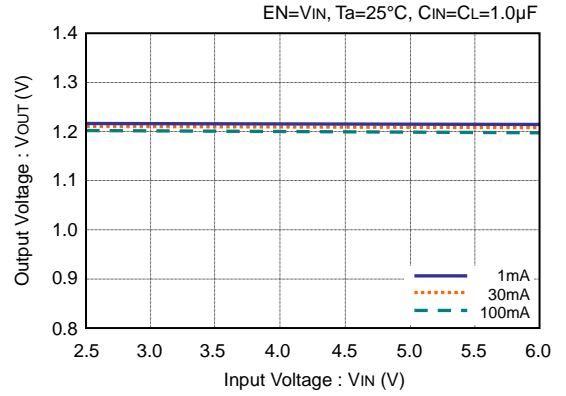

● **VRH1802xxx (VOUT=1.8V)**

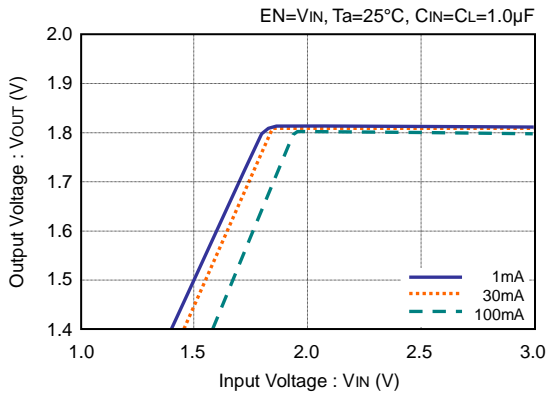

● **VRH1802xxx (VOUT=1.8V)**

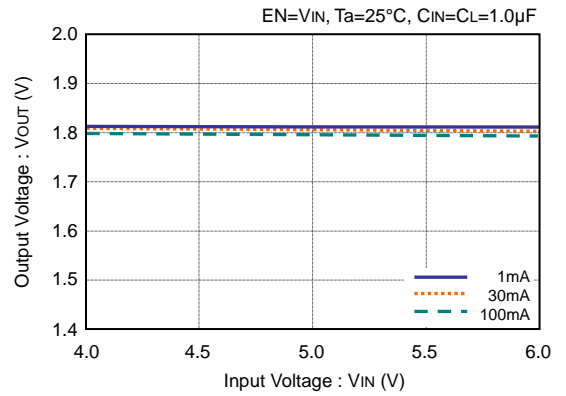

● **VRH2801xxx (VOUT=2.8V)**

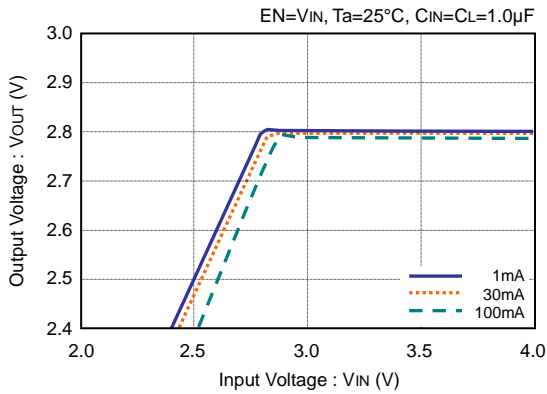

● **VRH2801xxx (VOUT=2.8V)**

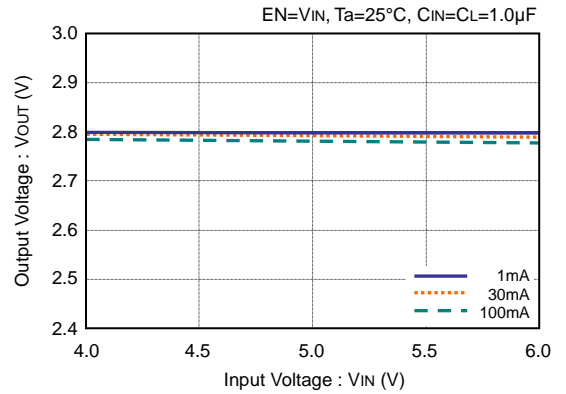

TYPICAL CHARACTERISTICS – Output Voltage vs. Input Voltage (continued)

● **VRH3001xxx (V_{OUT}=3.0V)**

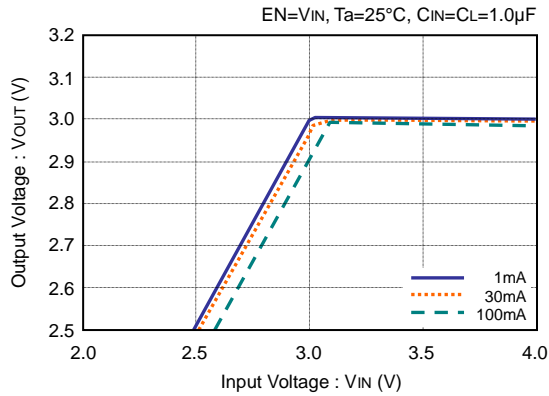

● **VRH3001xxx (V_{OUT}=3.0V)**

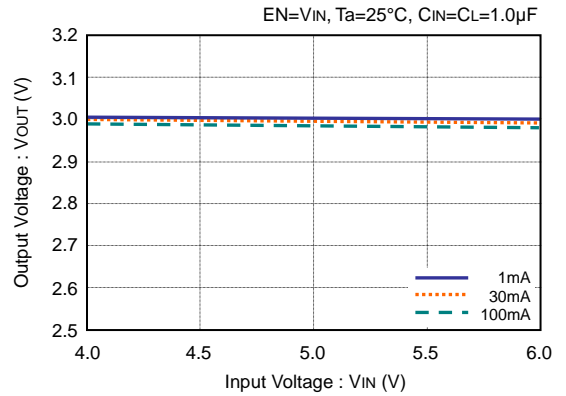

● **VRH3301xxx (V_{OUT}=3.3V)**

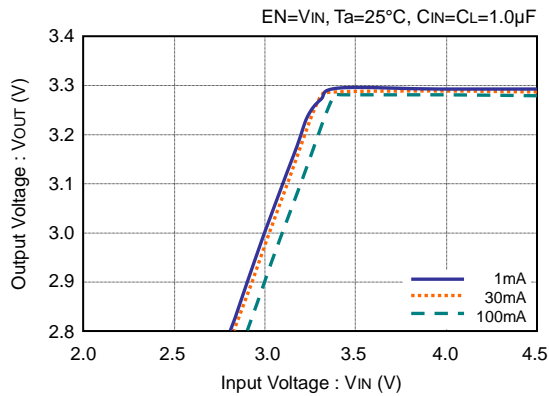

● **VRH3301xxx (V_{OUT}=3.3V)**

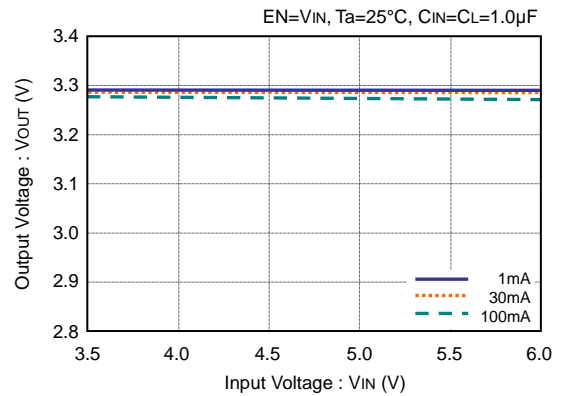

TYPICAL CHARACTERISTICS – Dropout Voltage vs. Output Current

● **VRH1202xxx (V_{OUT}=1.2V)**

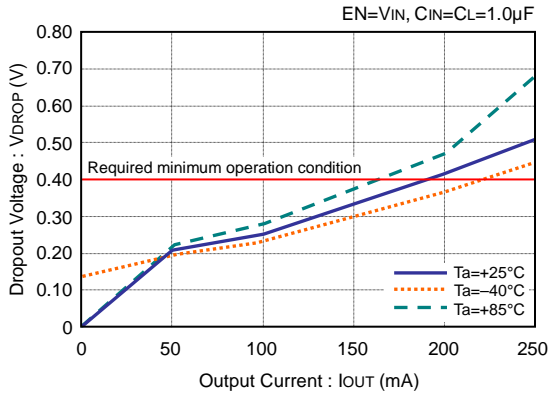

● **VRH1802xxx (V_{OUT}=1.8V)**

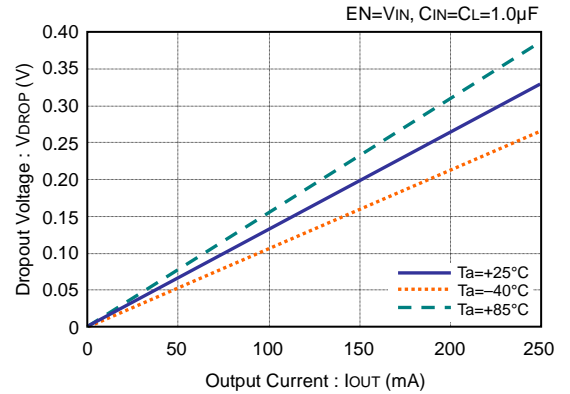

● **VRH2801xxx (V_{OUT}=2.8V)**

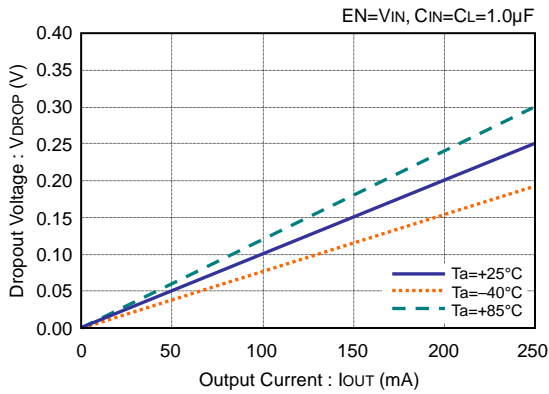

● **VRH3001xxx (V_{OUT}=3.0V)**

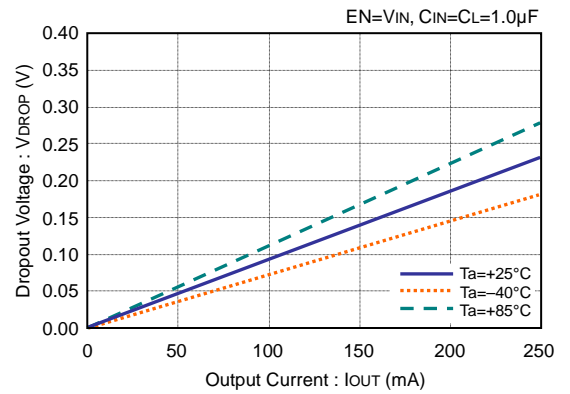

● **VRH3301xxx (V_{OUT}=3.3V)**

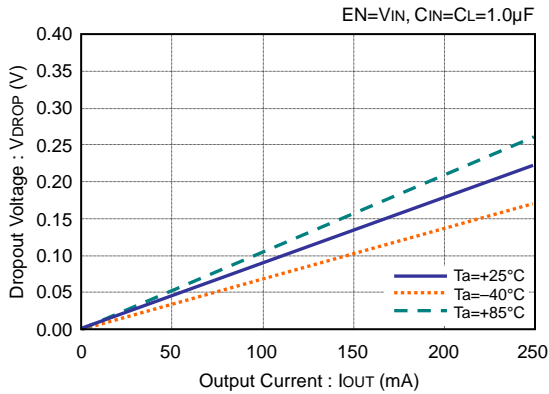

TYPICAL CHARACTERISTICS – Output Voltage vs. Ambient Temperature

● **VRH1202xxx (VOUT=1.2V)**



● **VRH1802xxx (VOUT=1.8V)**



● **VRH2801xxx (VOUT=2.8V)**



● **VRH3001xxx (VOUT=3.0V)**



● **VRH3301xxx (VOUT=3.3V)**



TYPICAL CHARACTERISTICS – CL-Discharge Resistance vs. Ambient Temperature



TYPICAL CHARACTERISTICS – Supply Current vs. Input Voltage

● **VRH1202xxx (VOUT=1.2V)**

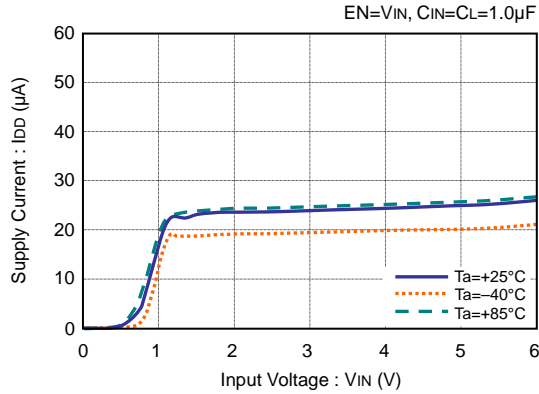

● **VRH1802xxx (VOUT=1.8V)**

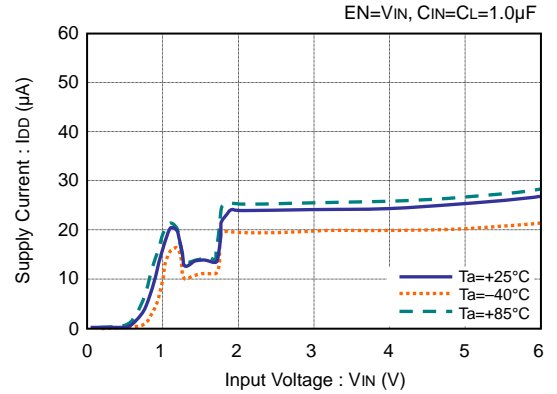

● **VRH2801xxx (VOUT=2.8V)**

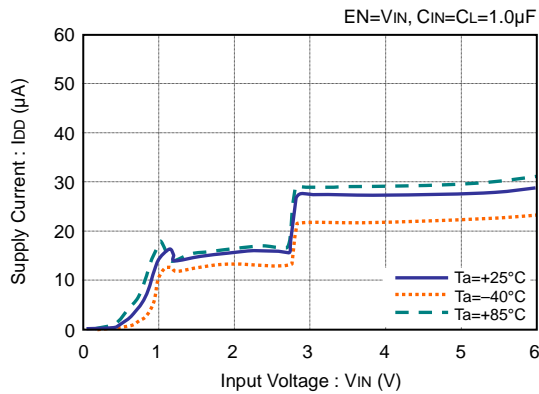

● **VRH3001xxx (VOUT=3.0V)**

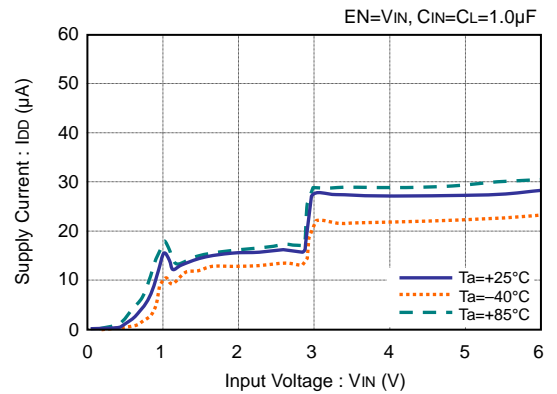

● **VRH3301xxx (VOUT=3.3V)**

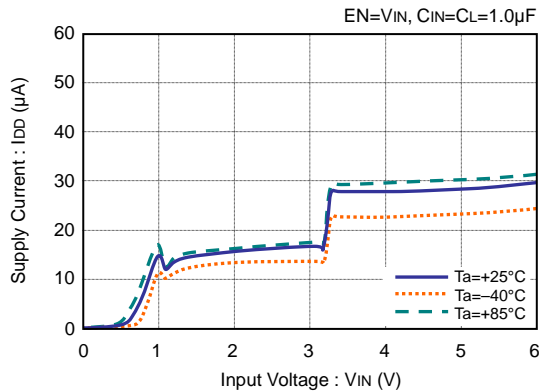

TYPICAL CHARACTERISTICS – Load Transient Response

● **VRH1202xxx (VOUT=1.2V)**

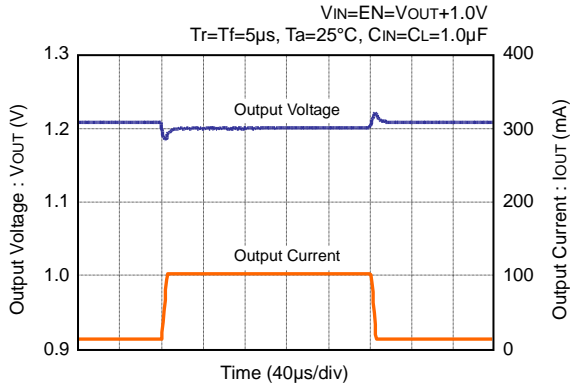

● **VRH1802xxx (VOUT=1.8V)**

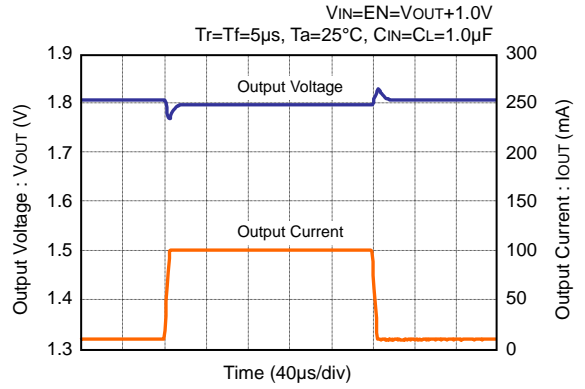

● **VRH2801xxx (VOUT=2.8V)**

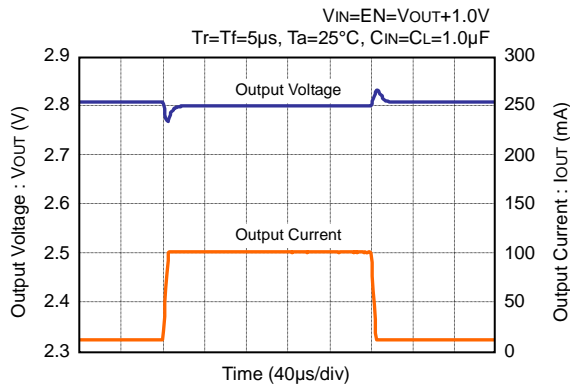

● **VRH3001xxx (VOUT=3.0V)**

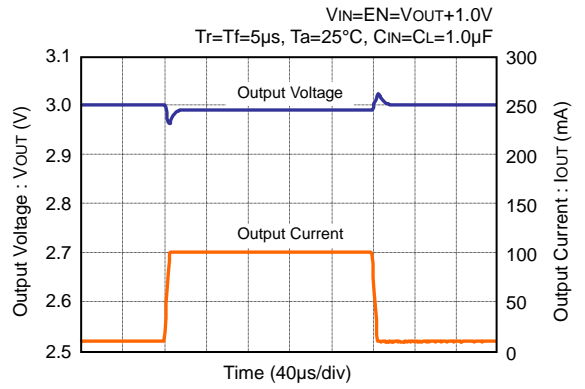

● **VRH3301xxx (VOUT=3.3V)**

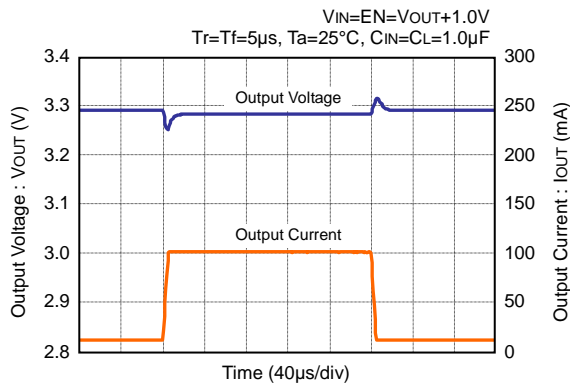

TYPICAL CHARACTERISTICS – Input Transient Response ($I_{OUT}=1mA$)

● **VRH1202xxx ($V_{OUT}=1.2V$)**

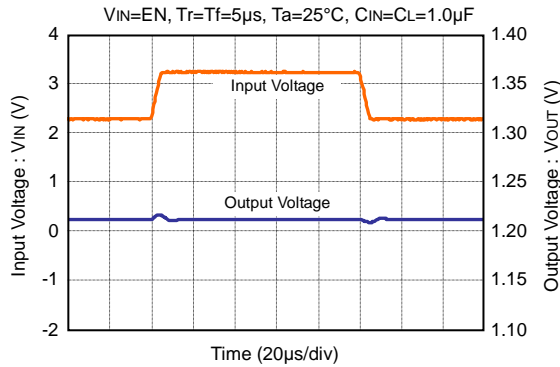

● **VRH1802xxx ($V_{OUT}=1.8V$)**

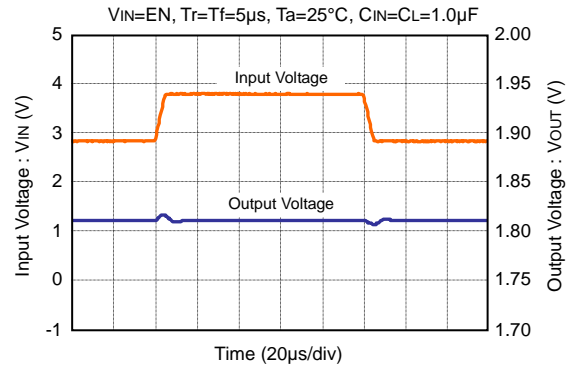

● **VRH2801xxx ($V_{OUT}=2.8V$)**

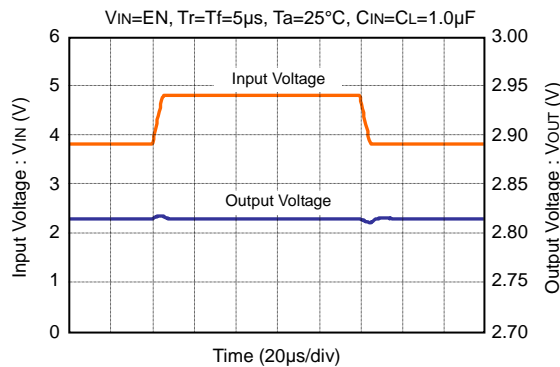

● **VRH3001xxx ($V_{OUT}=3.0V$)**

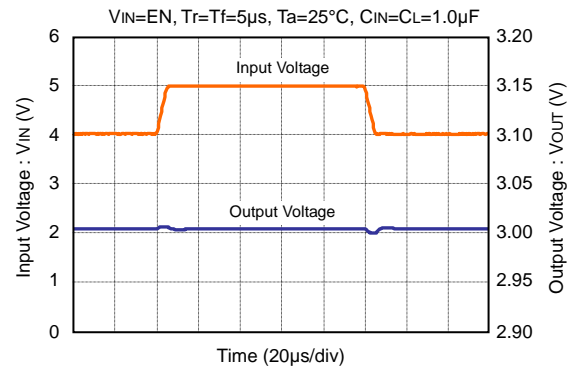

● **VRH3301xxx ($V_{OUT}=3.3V$)**

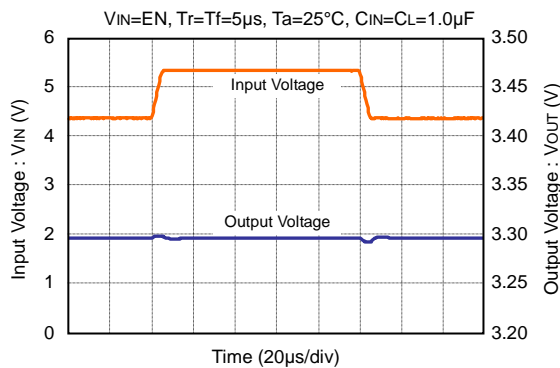

TYPICAL CHARACTERISTICS – Input Transient Response ($I_{OUT}=30mA$)

● **VRH1202xxx ($V_{OUT}=1.2V$)**

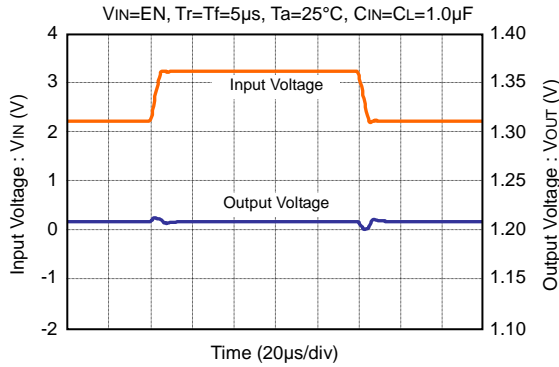

● **VRH1802xxx ($V_{OUT}=1.8V$)**

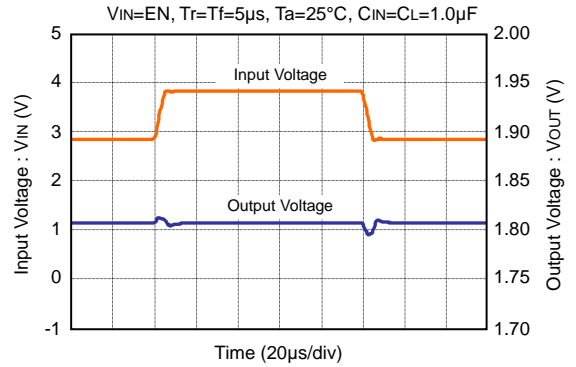

● **VRH2801xxx ($V_{OUT}=2.8V$)**

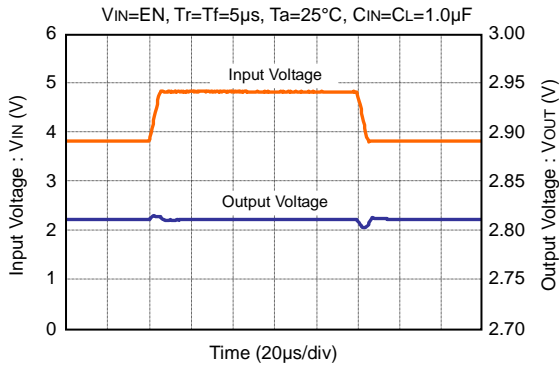

● **VRH3001xxx ($V_{OUT}=3.0V$)**

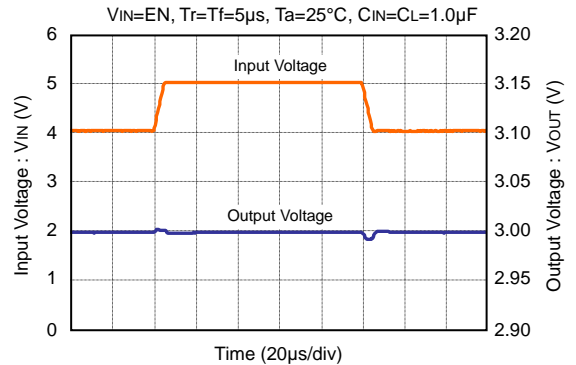

● **VRH3301xxx ($V_{OUT}=3.3V$)**

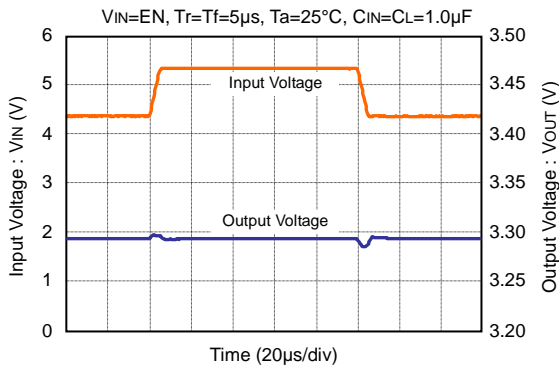

TYPICAL CHARACTERISTICS – Input Transient Response ($I_{OUT}=100mA$)

● **VRH1202xxx ($V_{OUT}=1.2V$)**



● **VRH1802xxx ($V_{OUT}=1.8V$)**

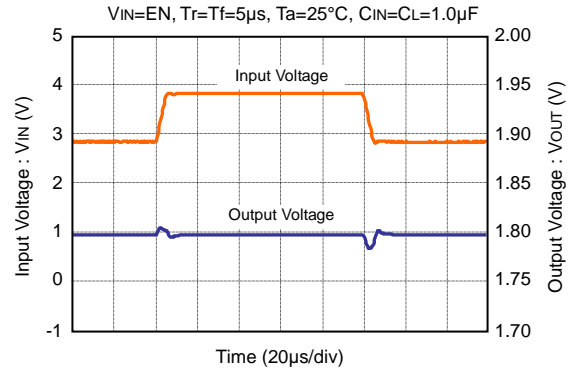

● **VRH2801xxx ($V_{OUT}=2.8V$)**



● **VRH3001xxx ($V_{OUT}=3.0V$)**

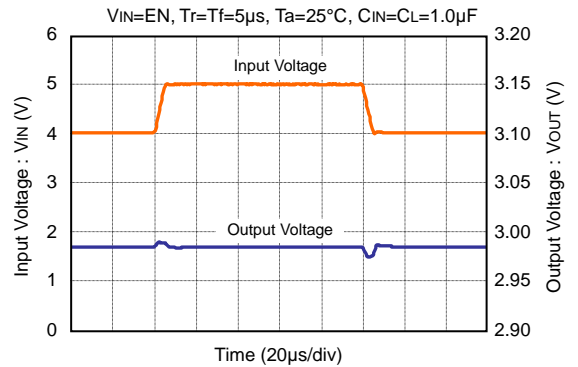

● **VRH3301xxx ($V_{OUT}=3.3V$)**



TYPICAL CHARACTERISTICS – Input Rise Time ($I_{OUT}=1mA$)

● **VRH1202xxx ($V_{OUT}=1.2V$)**

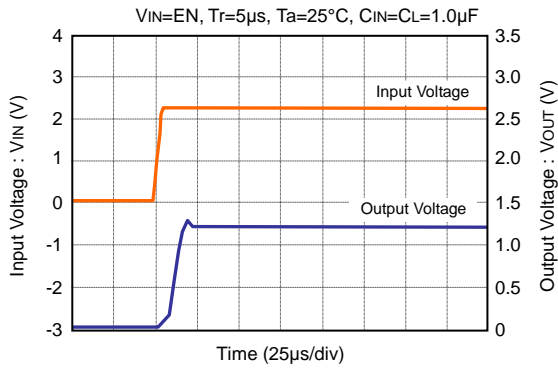

● **VRH1802xxx ($V_{OUT}=1.8V$)**

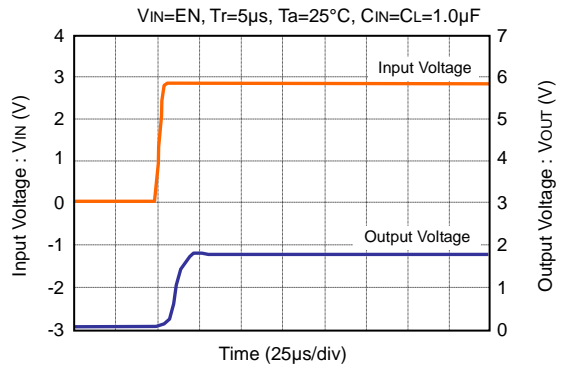

● **VRH2801xxx ($V_{OUT}=2.8V$)**

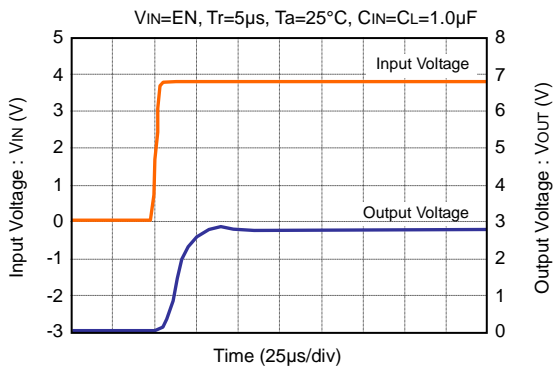

● **VRH3001xxx ($V_{OUT}=3.0V$)**

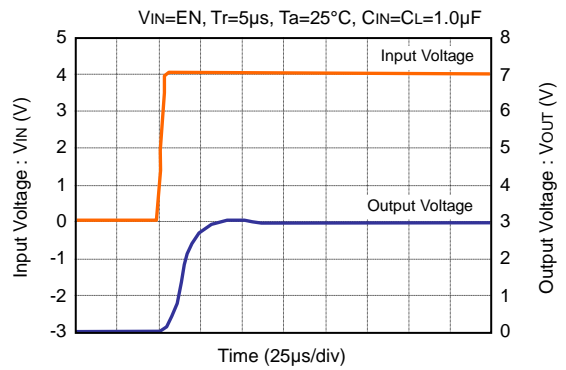

● **VRH3301xxx ($V_{OUT}=3.3V$)**

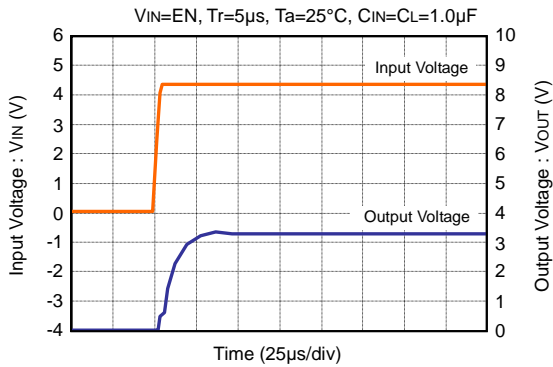

TYPICAL CHARACTERISTICS – Input Rise Time ($I_{OUT}=30mA$)

● **VRH1202xxx ($V_{OUT}=1.2V$)**

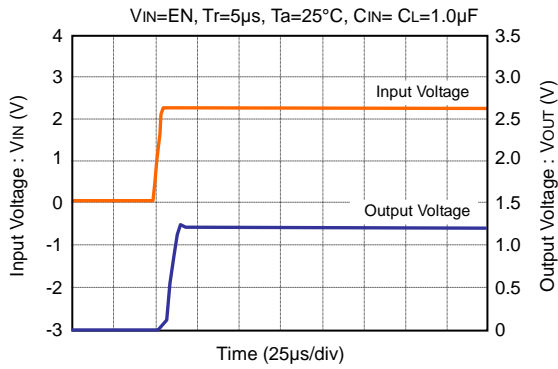

● **VRH1802xxx ($V_{OUT}=1.8V$)**

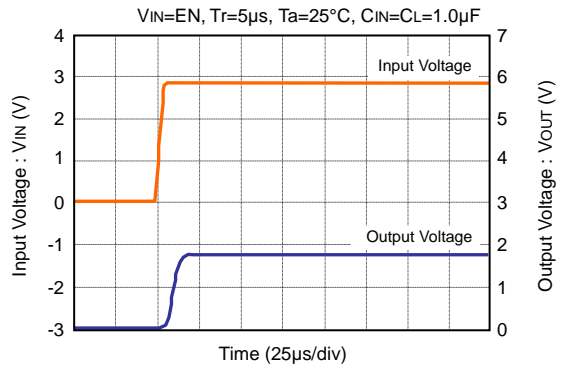

● **VRH2801xxx ($V_{OUT}=2.8V$)**

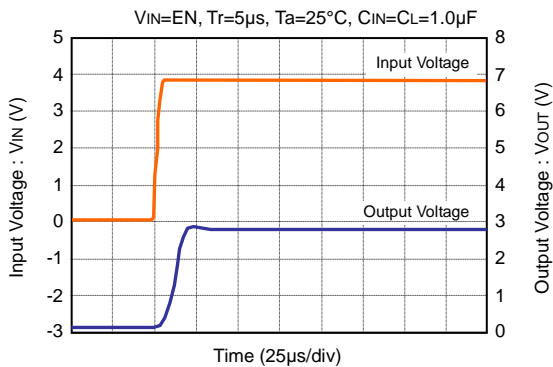

● **VRH3001xxx ($V_{OUT}=3.0V$)**

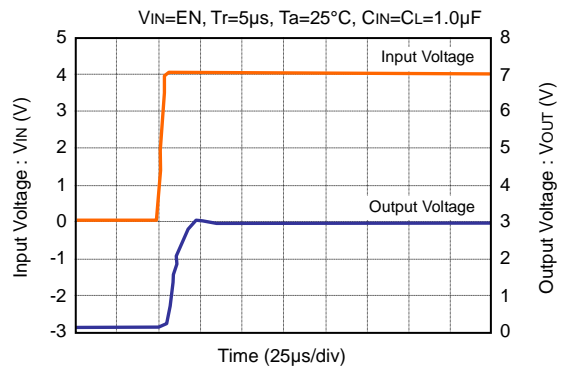

● **VRH3301xxx ($V_{OUT}=3.3V$)**

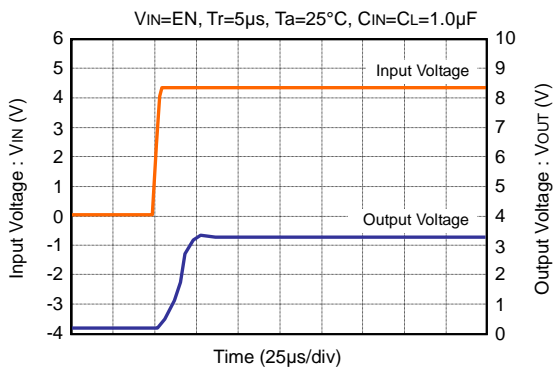

TYPICAL CHARACTERISTICS – Input Rise Time ($I_{OUT}=100mA$)

● **VRH1202xxx ($V_{OUT}=1.2V$)**

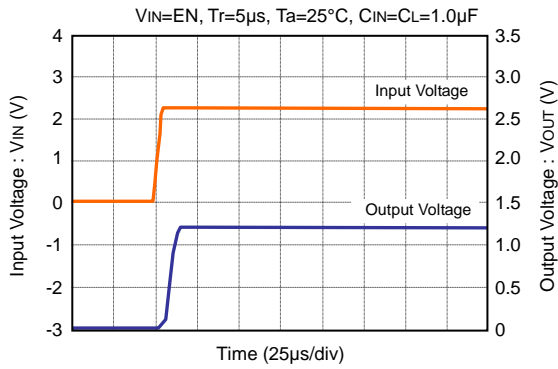

● **VRH1802xxx ($V_{OUT}=1.8V$)**

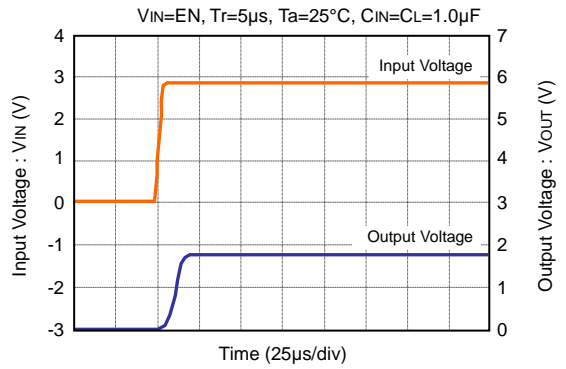

● **VRH2801xxx ($V_{OUT}=2.8V$)**

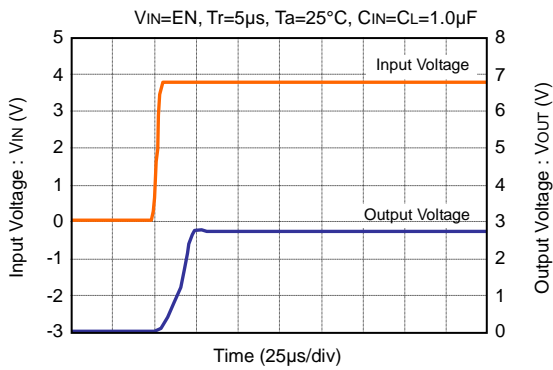

● **VRH3001xxx ($V_{OUT}=3.0V$)**

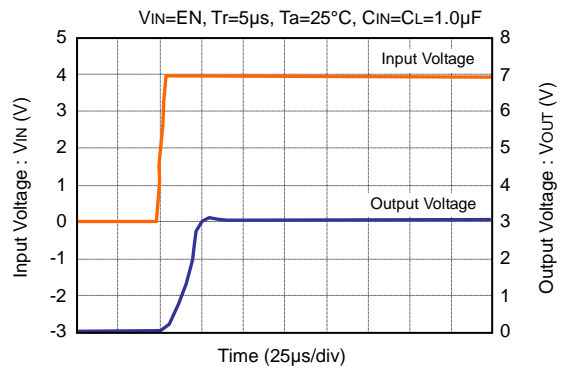

● **VRH3301xxx ($V_{OUT}=3.3V$)**

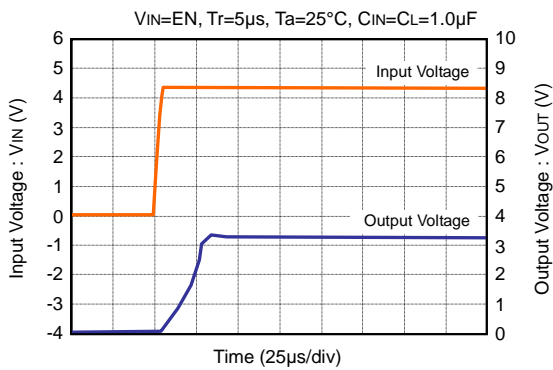

TYPICAL CHARACTERISTICS – EN Rise Time ($I_{OUT}=1mA$)

● **VRH1202xxx ($V_{OUT}=1.2V$)**

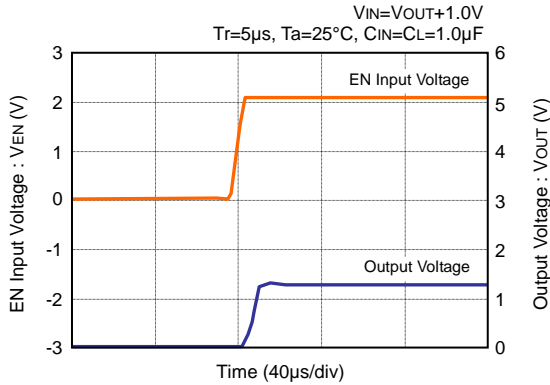

● **VRH1802xxx ($V_{OUT}=1.8V$)**

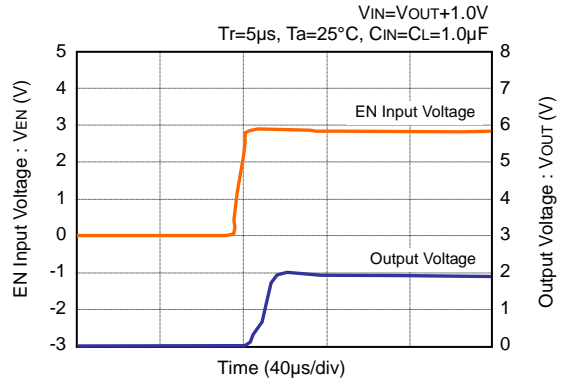

● **VRH2801xxx ($V_{OUT}=2.8V$)**

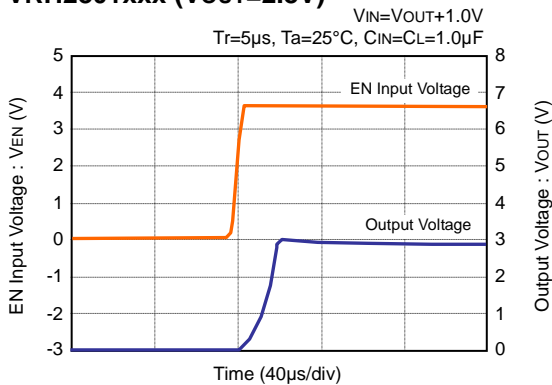

● **VRH3001xxx ($V_{OUT}=3.0V$)**

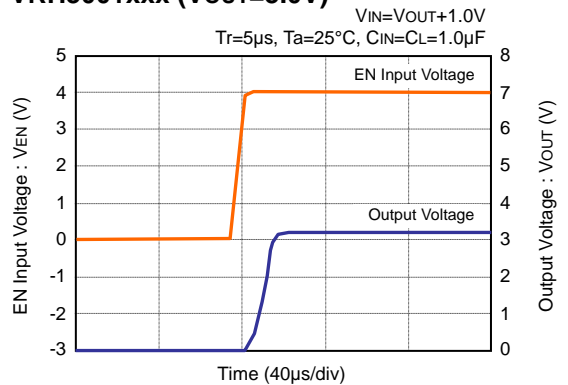

● **VRH3301xxx ($V_{OUT}=3.3V$)**

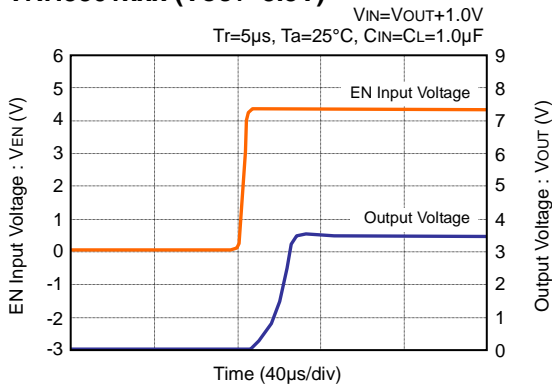

TYPICAL CHARACTERISTICS – EN Rise Time (I_{OUT}=30mA)

● **VRH1202xxx (V_{OUT}=1.2V)**

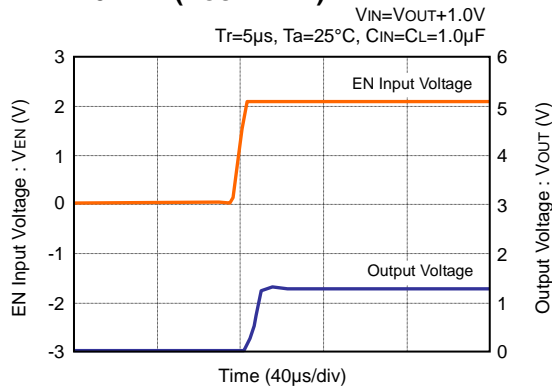

● **VRH1802xxx (V_{OUT}=1.8V)**

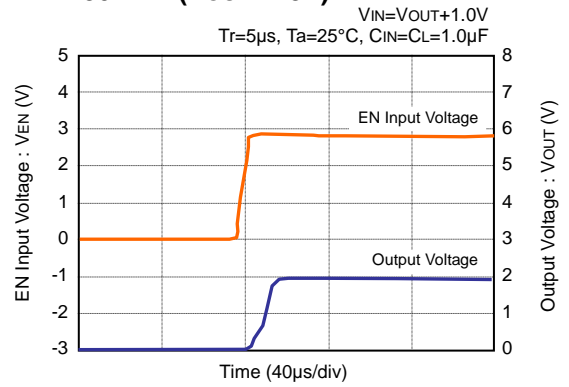

● **VRH2801xxx (V_{OUT}=2.8V)**

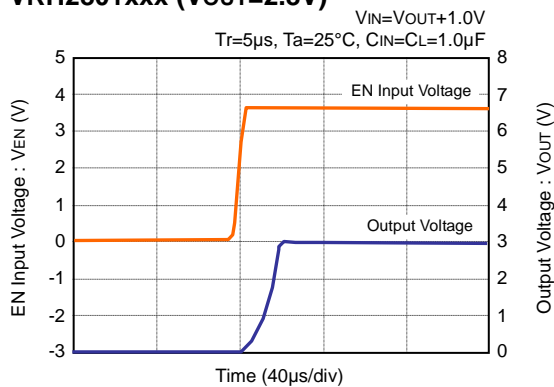

● **VRH3001xxx (V_{OUT}=3.0V)**

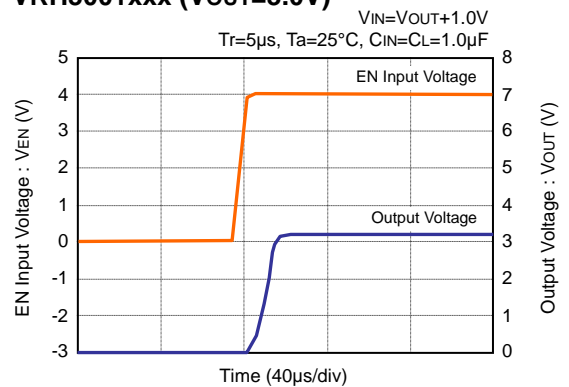

● **VRH3301xxx (V_{OUT}=3.3V)**

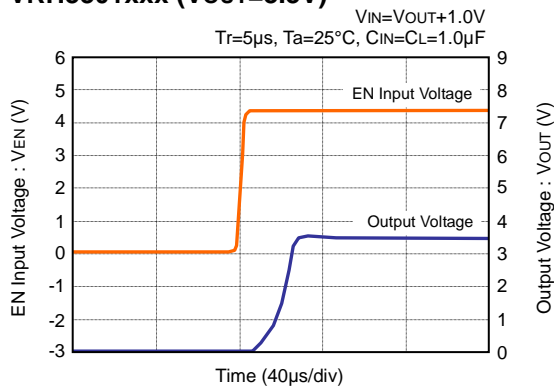

TYPICAL CHARACTERISTICS – EN Rise Time ($I_{OUT}=100mA$)

● **VRH1202xxx ($V_{OUT}=1.2V$)**

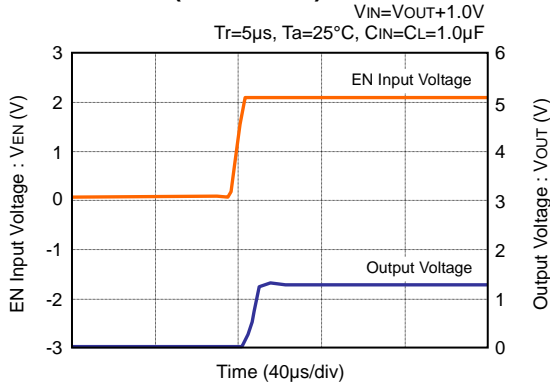

● **VRH1802xxx ($V_{OUT}=1.8V$)**

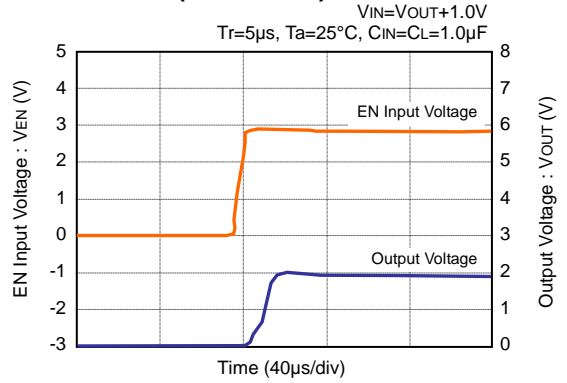

● **VRH2801xxx ($V_{OUT}=2.8V$)**

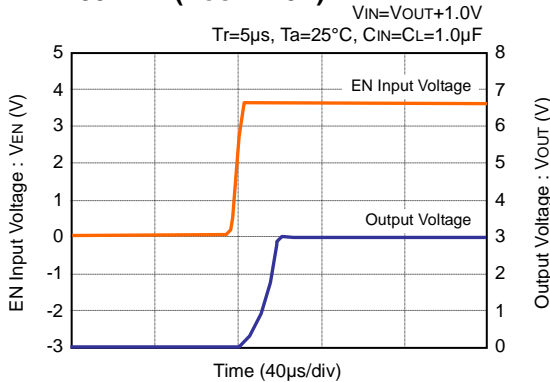

● **VRH3001xxx ($V_{OUT}=3.0V$)**

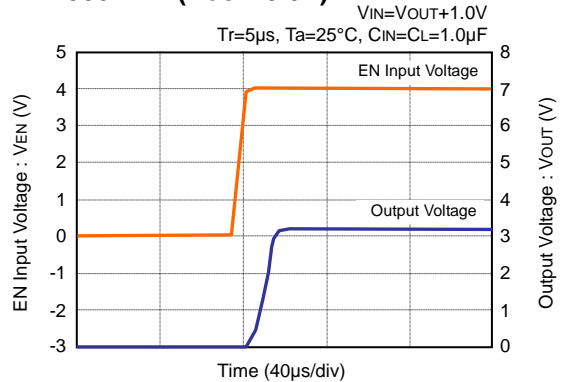

● **VRH3301xxx ($V_{OUT}=3.3V$)**

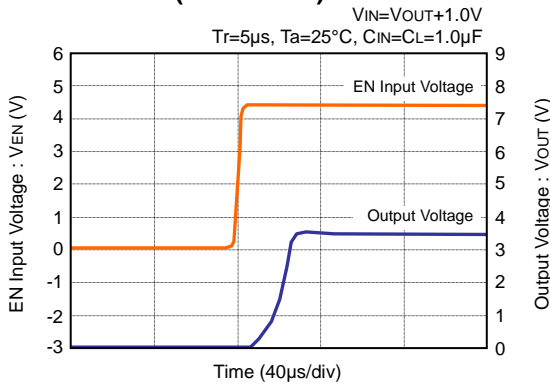

TYPICAL CHARACTERISTICS – Ripple Rejection Rate

● **VRH1202xxx (VOUT=1.2V)**

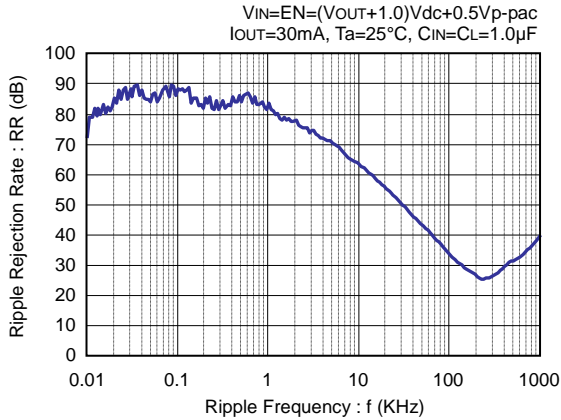

● **VRH1802xxx (VOUT=1.8V)**

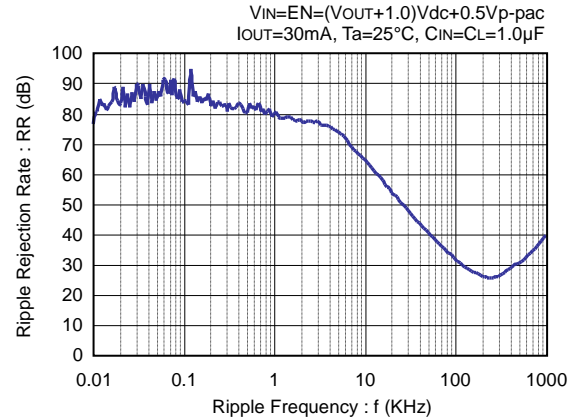

● **VRH2801xxx (VOUT=2.8V)**

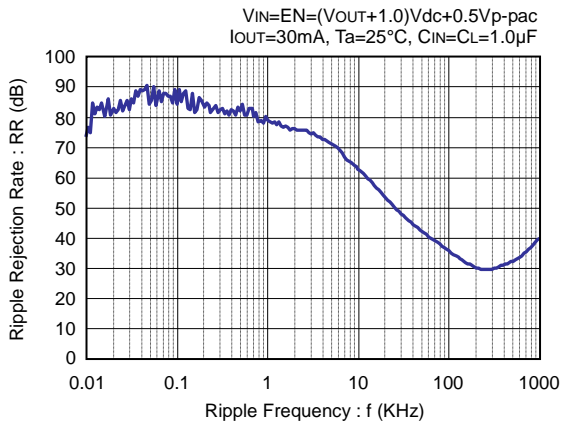

● **VRH3001xxx (VOUT=3.0V)**

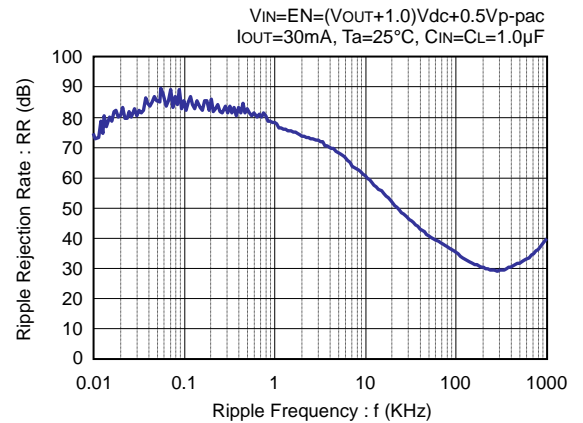

● **VRH3301xxx (VOUT=3.3V)**

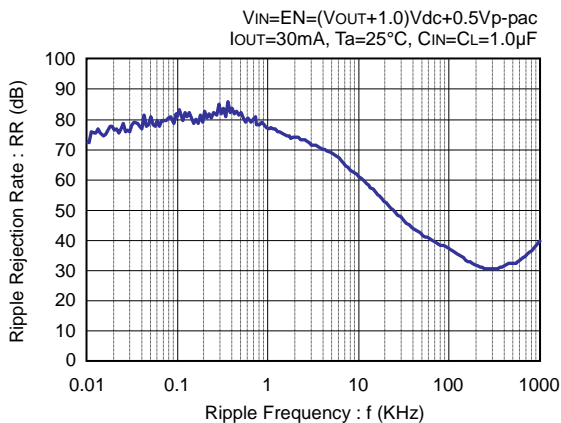

PACKAGE DIMENSIONS (SOT-25)

(Unit : mm)

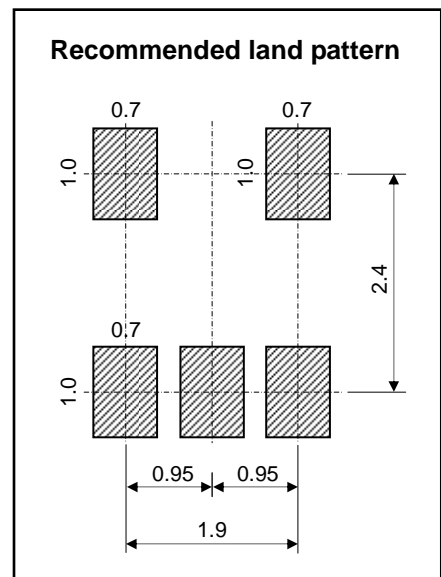
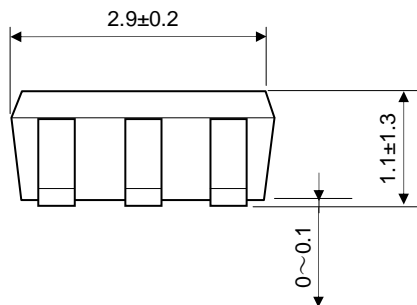
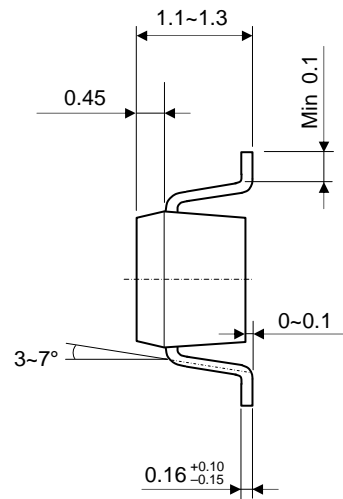
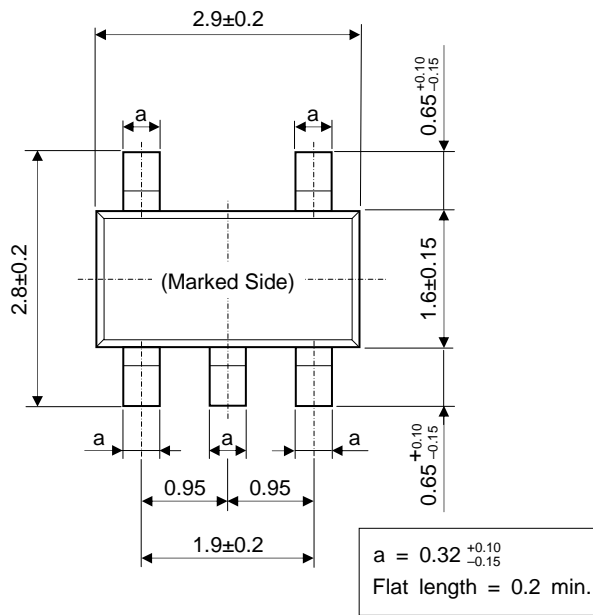

TAPING AND LOADING SPECIFICATIONS (SOT-25)

(Unit : mm)



REEL DIMENSIONS (SOT-25)

(Unit : mm)

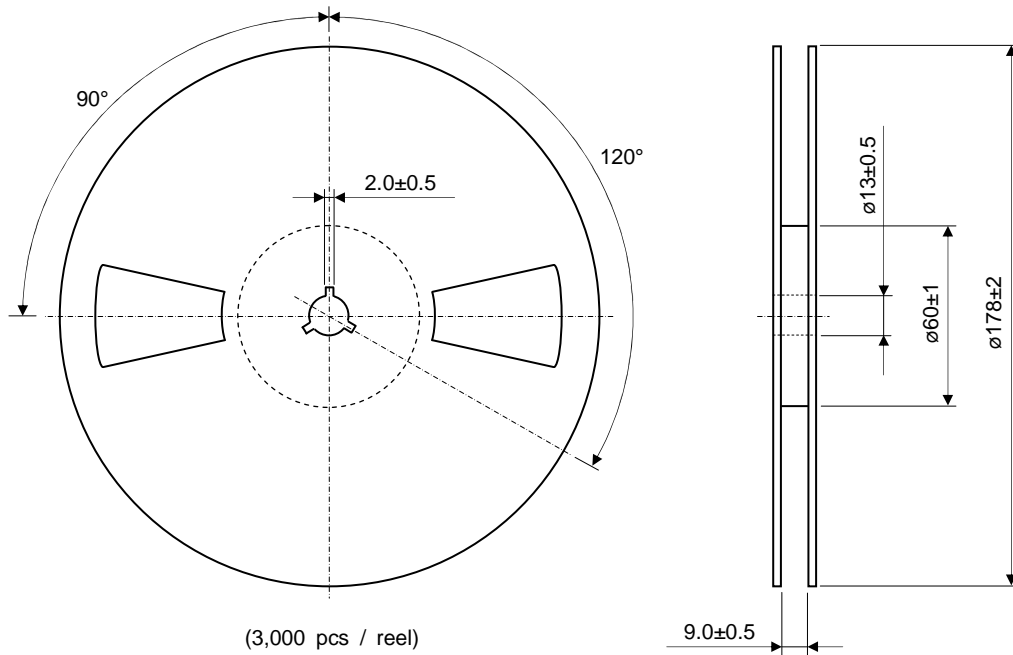

PACKAGE DIMENSIONS (LLP-4)

(Unit : mm)

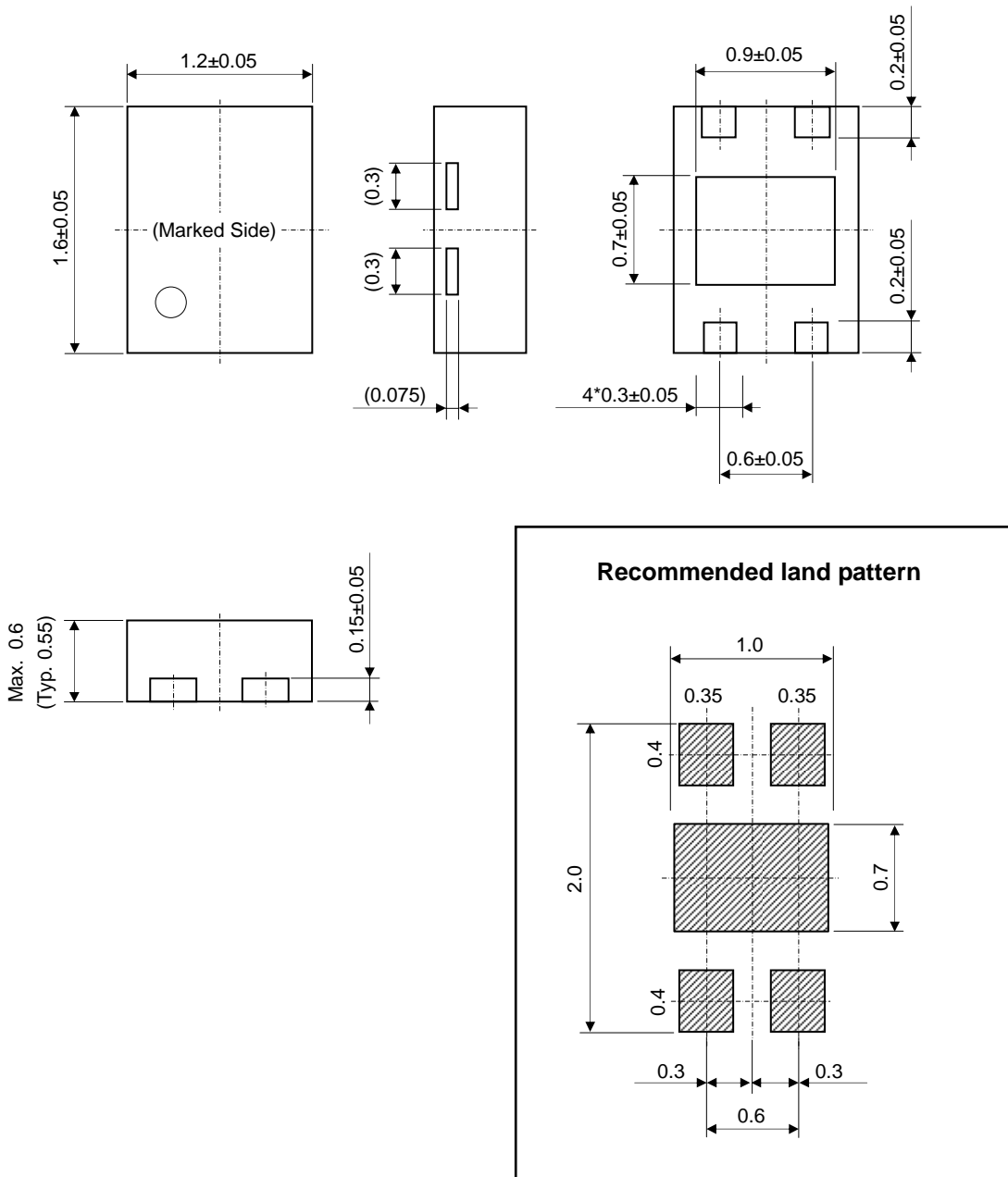

PACKAGE DIMENSIONS (SDFN-4)

(Unit : mm)

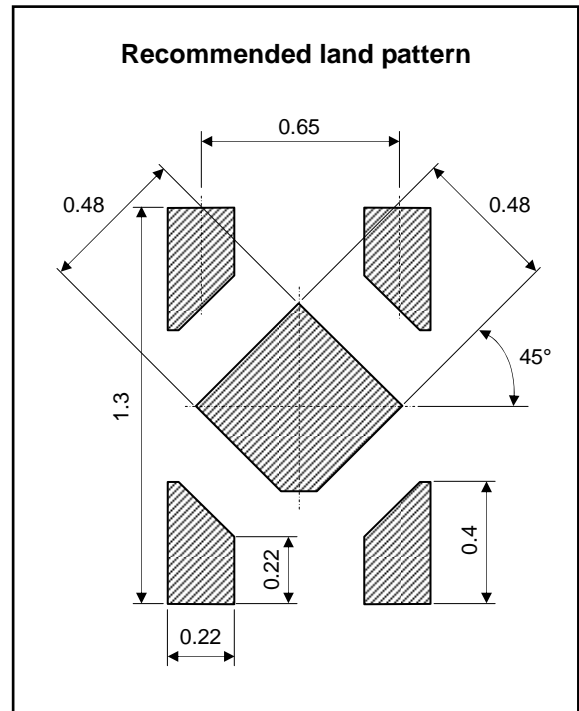
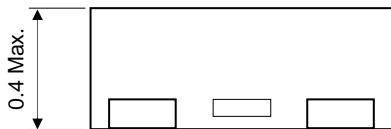

TAPING AND LOADING SPECIFICATIONS (SDFN-4)

(Unit : mm)



REEL DIMENSIONS (SDFN-4)

(Unit : mm)





AnaSem may change the products described in this data sheet, or may discontinue production or services without any notice in order to supply the best products through improve the design and performance. Customers are recommended to obtain the latest data or information before placing orders in order to make sure the data or information required is the newest. It is necessary for customers to fully understand the products described in this data sheet and to use it in accordance with its specifications. The products described in this data sheet are not intended to use for the apparatus which have influence on human lives due to the failure or malfunction of the products. AnaSem Corp. is not responsible for any support to customer's application, product design, software performance, patent infringement or service. AnaSem Corp. does not disclose or imply a guarantee or description about being licensed based on patents, copy-rights, circuit location license, or other intellectual properties associated with the devices or combinations in which the products or service of AnaSem Corp. are used or can be used, or which cover the methods. Customers should not export, directly or indirectly, any products without obtaining required licenses and approvals in advance from appropriate government agencies.

AnaSem

www.anasemi.com

sales@anasemi.com

GENUINE PRODUCT LEGITIMATE LABEL DEFINITION



X-ON Electronics

Largest Supplier of Electrical and Electronic Components

Click to view similar products for [anase](#) manufacturer:

Other Similar products are found below :

[VDA1810NTA](#) [VDA4410NTA](#) [VDA1810CTA](#) [VRH1802LLX](#) [VRH1852LTX](#) [VDA2210CTA](#) [VDA1520NTA](#) [VDA4810NTA](#)
[VDA1020NTA](#) [VDA4210CTA](#) [VDA3110CTA](#) [VRD3333PTX](#) [VRH3301NVX](#) [VDA2210NTA](#) [VDA2610CTA](#) [VDA5310CTA](#)
[VDD181MCTA](#) [VDD251LCTA](#) [VDA2810CTA](#) [VDA3110NTA](#) [VDA4110NTA](#) [VDA4710NTA](#) [VDA5510CTA](#) [VDD301MNTA](#)
[VDA2910NTA](#) [VDA1120NTA](#) [VRH3001NSX](#) [VRD1328MNX](#) [VDA4310NTA](#) [VDA1220NTA](#) [VDA1420NTA](#) [VDD181MNTA](#)
[VDD261MCTA](#) [VDA0820CTA](#) [VRD1230MTX](#) [VRD1833MLX](#) [VRD3033PTX](#) [VDD261SCTA](#) [VDD281MCTA](#) [VDD291LCTA](#)
[VDA1120CTA](#) [VDA3210NTA](#) [VDA3810CTA](#) [VRD3232PLX](#) [VRD3233PLX](#) [VRH1202LLX](#) [VRH1802LVX](#) [VRH2601NLX](#)
[VRH2801NSX](#) [VRH2851NLX](#)