

Product Summary

$V_{(BR)DSS}$	$R_{DS(on)MAX}$	I_D	$V_{(BR)DSS}$	$R_{DS(on)MAX}$	I_D
30V	30mΩ@10V	6A	-30V	30mΩ@-10V	-6.5A
	42mΩ@4.5V			45mΩ@-4.5V	

Feature

- Advanced trench process technology
- High Density Cell Design For Ultra Low On-Resistance
- Surface mount package

Application

- Power Management
- DC/DC Converter
- LCD TV & Monitor Display inverter
- CCFL inverter
- LCD Display inverter

Package



SOP-8

Circuit diagram

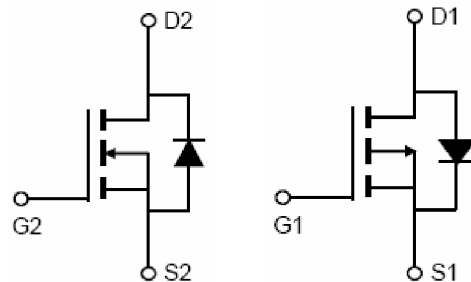

Marking

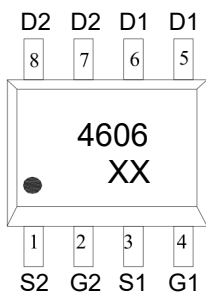

Absolute maximum ratings (Ta=25°C unless otherwise noted)

Parameter	Symbol	N-Channel	p-Channel	Unit
Drain-Source Voltage	V _{DS}	30	-30	V
Gate-Source Voltage	V _{GS}	±20	±20	V
Continuous Drain Current	I _D	6	-6.5	A
Pulsed Drain Current	I _{DM}	24	-25	A
Power Dissipation	P _D	2	2	W
Thermal Resistance from Junction to Ambient	R _{θJA}	62.5	62.5	°C/W
Junction Temperature	T _J	150	150	°C
Storage Temperature	T _{STG}	-55 ~ +150	-55 ~ +150	°C

N-CH Electrical characteristics (T_A=25 °C, unless otherwise noted)

Parameter	Symbol	Test Condition	Min.	Typ.	Max.	Unit
Static Characteristics						
Drain-source breakdown voltage	V _{(BR)DSS}	V _{GS} = 0V, I _D = 250μA	30			V
Zero gate voltage drain current	I _{DSS}	V _{DS} = 30V, V _{GS} = 0V			1	μA
Gate-body leakage current	I _{GSS}	V _{GS} = ±20V, V _{DS} = 0V			±100	nA
Gate threshold voltage	V _{GS(th)}	V _{DS} = V _{GS} , I _D = 250μA	1.0		2.2	V
Drain-source on-resistance ¹⁾	R _{DS(on)}	V _{GS} = 10V, I _D = 1A		18	30	mΩ
		V _{GS} = 4.5V, I _D = 1A		24	42	
Dynamic characteristics²⁾						
Input Capacitance	C _{iss}	V _{DS} = 15V, V _{GS} = 0V, f = 1MHz			310	pF
Output Capacitance	C _{oss}				60	
Reverse Transfer Capacitance	C _{rss}				50	
Total Gate Charge	Q _g	V _{DS} = 15V, V _{GS} = 10V, I _D = 6A			6	nC
Gate-Source Charge	Q _{gs}			0.85		
Gate-Drain Charge	Q _{gd}			1.3		
Turn-on delay time	t _{d(on)}	V _{DD} = 15V, V _{GS} = 10V, I _D = 1A, R _{GEN} = 3Ω, R _L = 2.5Ω		4.5		nS
Turn-on rise time	t _r			2.5		
Turn-off delay time	t _{d(off)}			14.5		
Turn-off fall time	t _f			3.5		
Source-Drain Diode characteristics						
Diode Forward voltage	V _{DS}	V _{GS} = 0V, I _S = 1A			1.2	V

P-CH Electrical characteristics (T_A=25 °C, unless otherwise noted)

Parameter	Symbol	Test Condition	Min.	Typ.	Max.	Unit
Static Characteristics						
Drain-source breakdown voltage	V _{(BR)DSS}	V _{GS} = 0V, I _D = -250μA	-30			V
Zero gate voltage drain current	I _{DSS}	V _{DS} = -30V, V _{GS} = 0V			-1	μA
Gate-body leakage current	I _{GSS}	V _{GS} = ±20V, V _{DS} = 0V			±100	nA
Gate threshold voltage	V _{GS(th)}	V _{DS} = V _{GS} , I _D = -250μA	-1.0		-2.2	V
Drain-source on-resistance ¹⁾	R _{DS(on)}	V _{GS} = -10V, I _D = -1A		24	30	mΩ
		V _{GS} = -4.5V, I _D = -1A		38	45	
Dynamic characteristics²⁾						
Input Capacitance	C _{iss}	V _{DS} = -15V, V _{GS} = 0V, f = 1MHz		760		pF
Output Capacitance	C _{oss}			140		
Reverse Transfer Capacitance	C _{rss}			95		
Total Gate Charge	Q _g	V _{DS} = -15V, V _{GS} = -10V, I _D = -6.5A			16	nC
Gate-Source Charge	Q _{gs}			2.5		
Gate-Drain Charge	Q _{gd}			3.2		
Turn-on delay time	t _{d(on)}	V _{DD} = -15V, V _{GS} = -10V, I _D = -1A, R _{GEN} = 3Ω, R _L = 2.3Ω		8		nS
Turn-on rise time	t _r			6		
Turn-off delay time	t _{d(off)}			17		
Turn-off fall time	t _f			5		
Source-Drain Diode characteristics						
Diode Forward voltage	V _{DS}	V _{GS} = 0V, I _S = -1A			-1.2	V

Notes:

- 1) Pulse Test: Pulse Width < 300μs, Duty Cycle ≤2%.
- 2) Guaranteed by design, not subject to production testing.

N- Channel Typical Electrical and Thermal Characteristics (Curves)

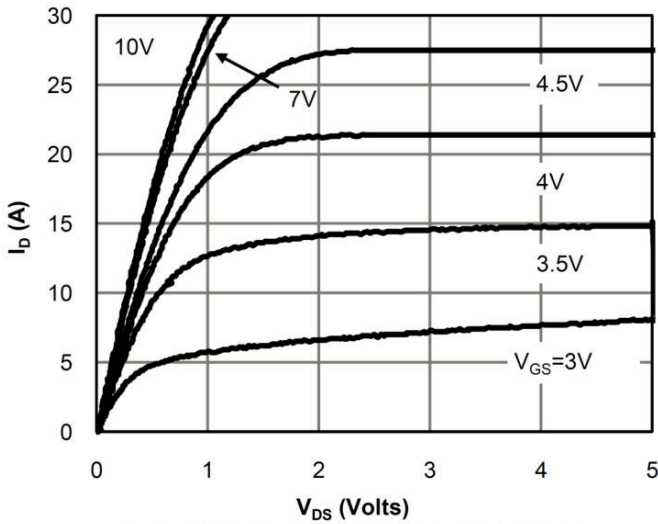

Fig 1: On-Region Characteristics (Note E)

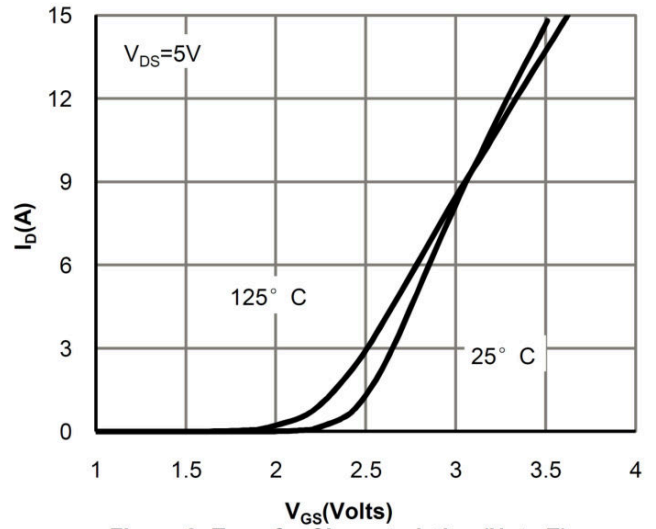

Figure 2: Transfer Characteristics (Note E)

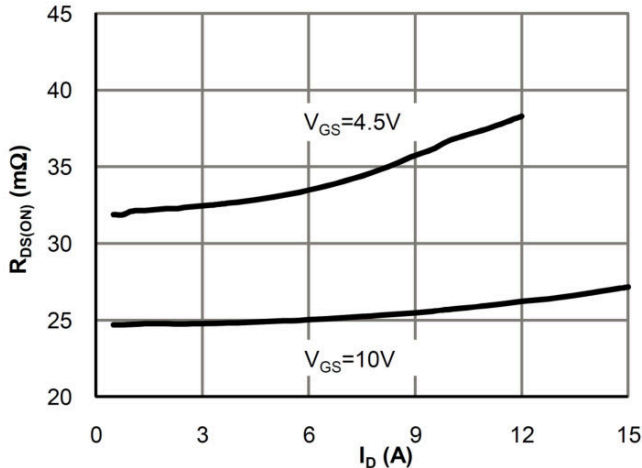

Figure 3: On-Resistance vs. Drain Current and Gate Voltage (Note E)

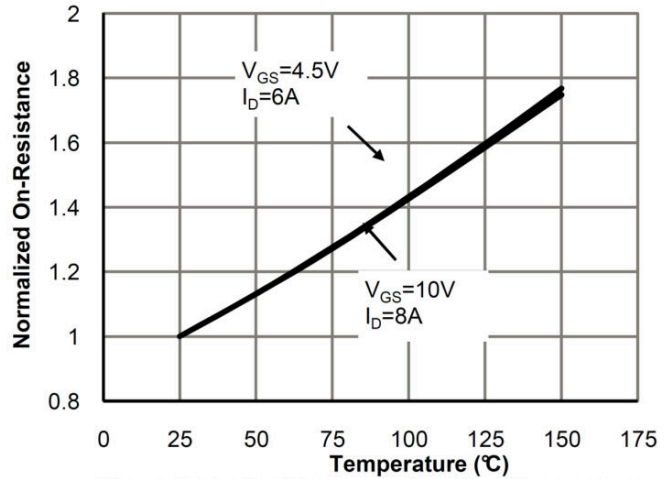

Figure 4: On-Resistance vs. Junction Temperature (Note E)

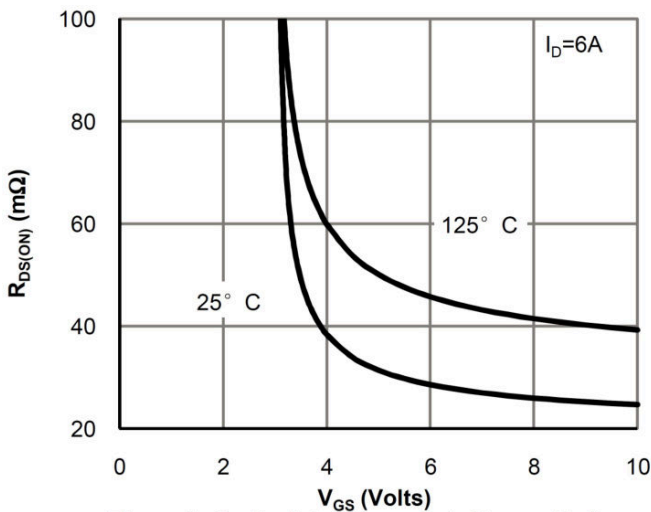

Figure 5: On-Resistance vs. Gate-Source Voltage (Note E)

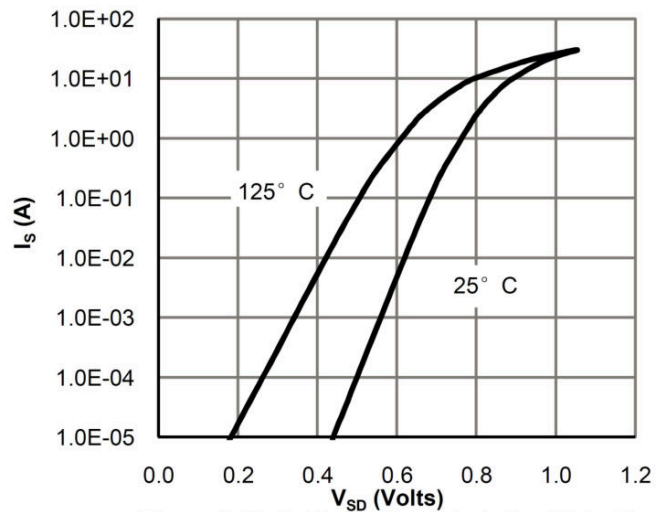

Figure 6: Body-Diode Characteristics (Note E)

N- Channel Typical Electrical and Thermal Characteristics (Curves)

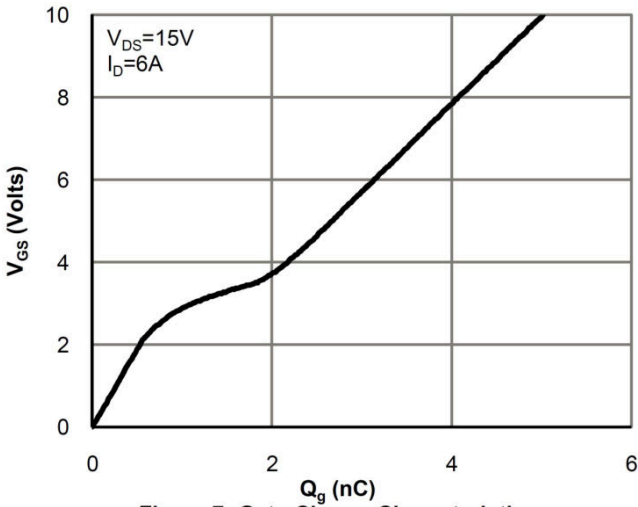

Figure 7: Gate-Charge Characteristics

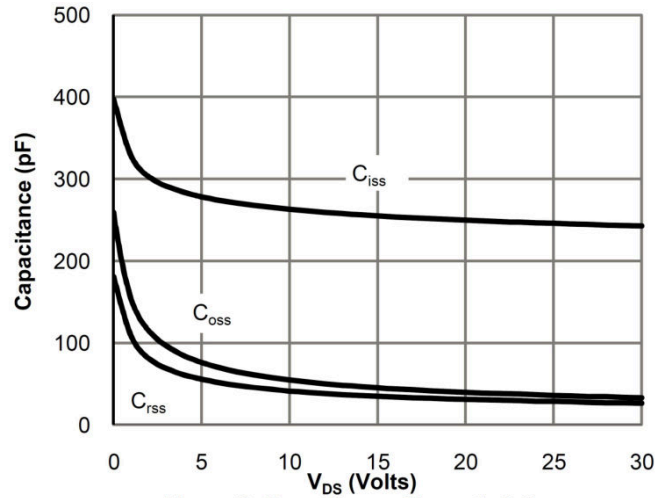

Figure 8: Capacitance Characteristics

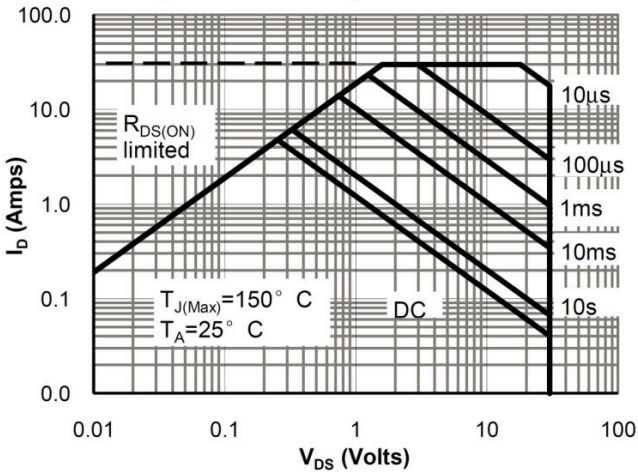

Figure 9: Maximum Forward Biased Safe Operating Area (Note F)

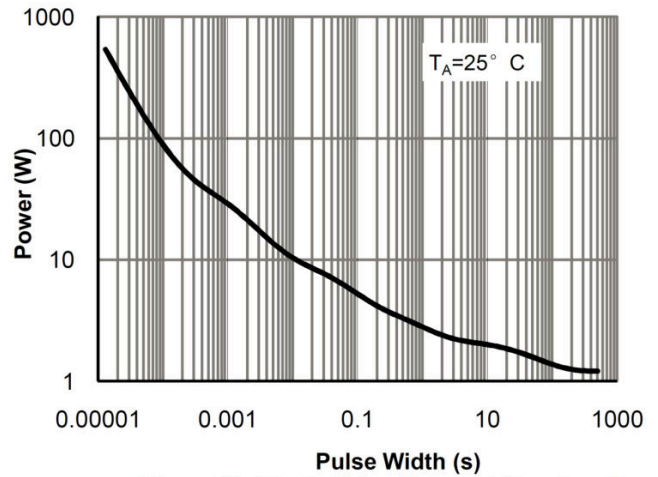

Figure 10: Single Pulse Power Rating Junction-to-Ambient (Note F)

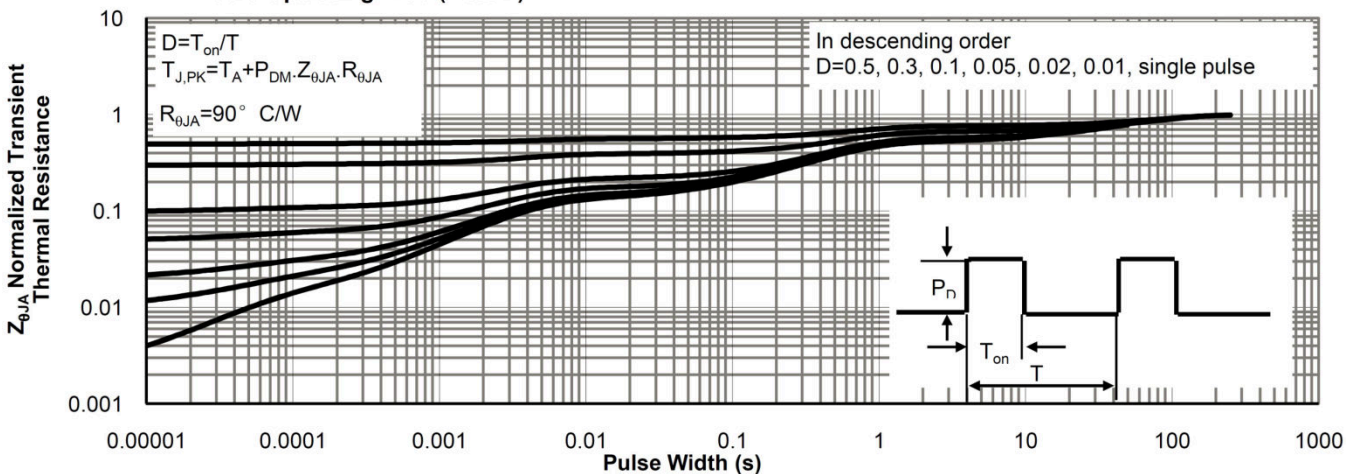

Figure 11: Normalized Maximum Transient Thermal Impedance (Note F)

P- Channel Typical Electrical and Thermal Characteristics (Curves)

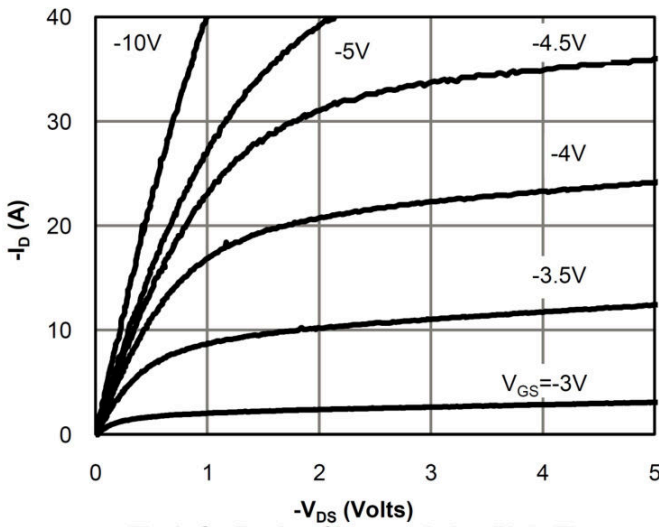

Fig 1: On-Region Characteristics (Note E)

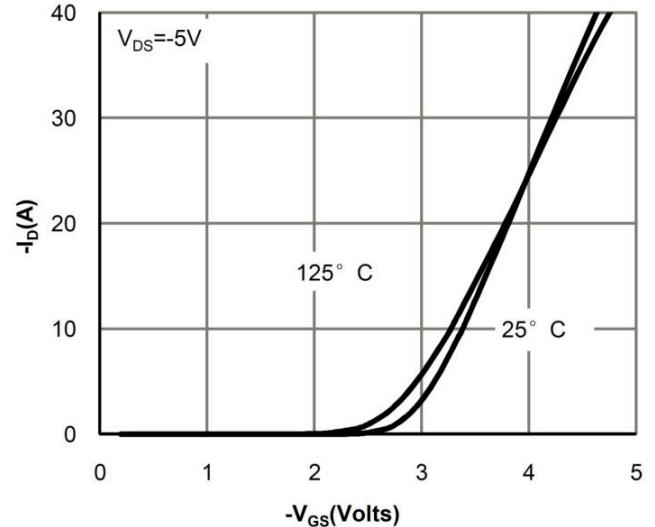

Figure 2: Transfer Characteristics (Note E)

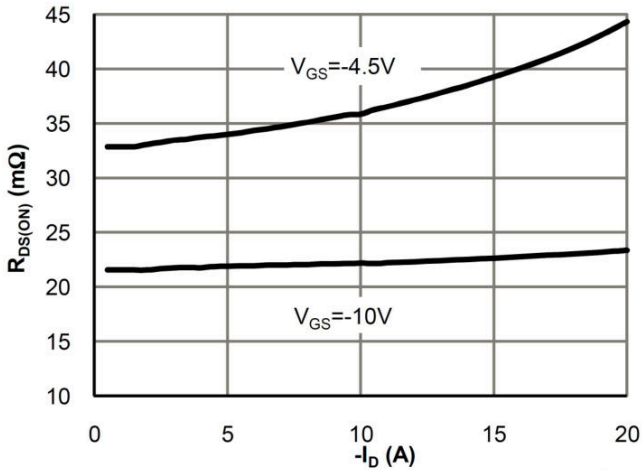

Figure 3: On-Resistance vs. Drain Current and Gate Voltage (Note E)

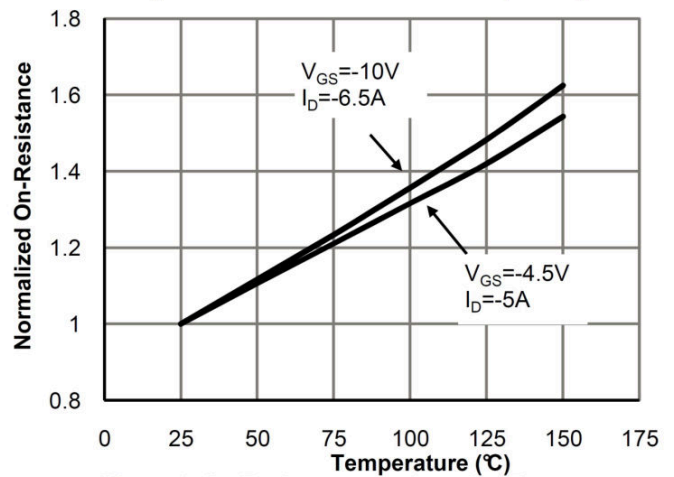

Figure 4: On-Resistance vs. Junction Temperature (Note E)

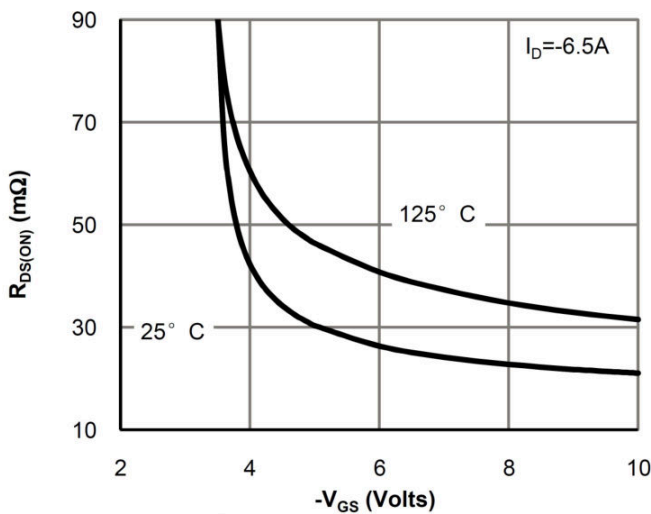

Figure 5: On-Resistance vs. Gate-Source Voltage (Note E)

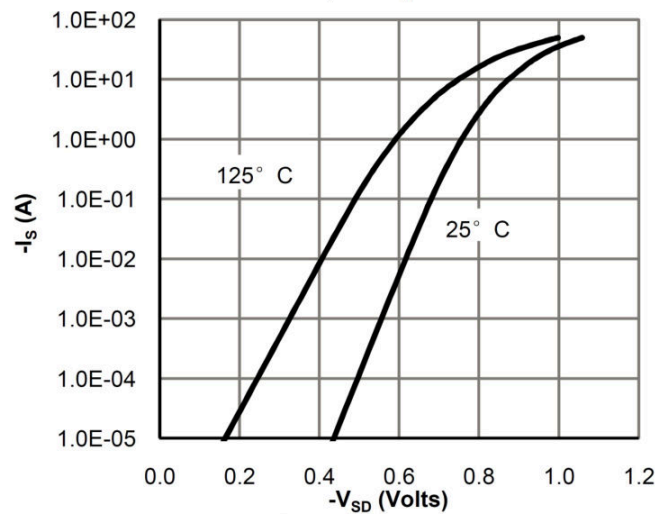

Figure 6: Body-Diode Characteristics (Note E)

P- Channel Typical Electrical and Thermal Characteristics (Curves)

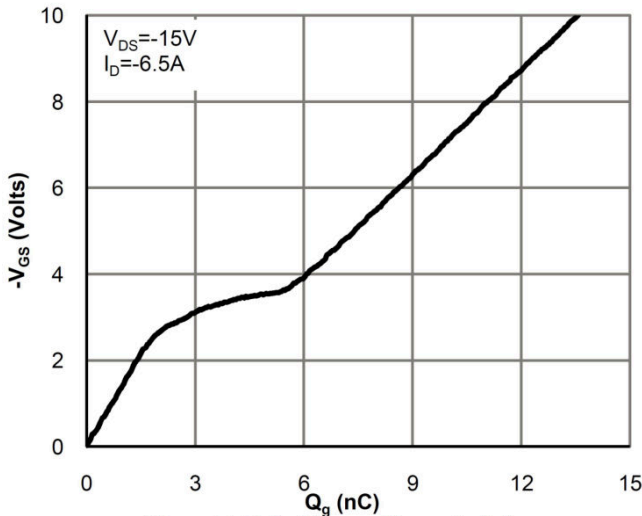

Figure 7: Gate-Charge Characteristics

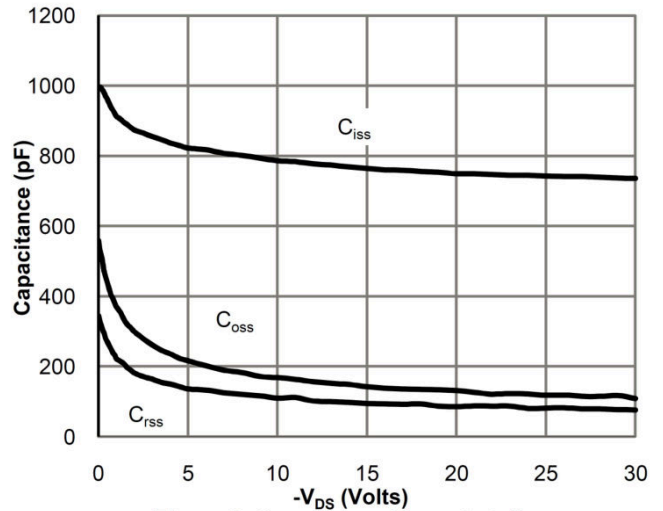

Figure 8: Capacitance Characteristics

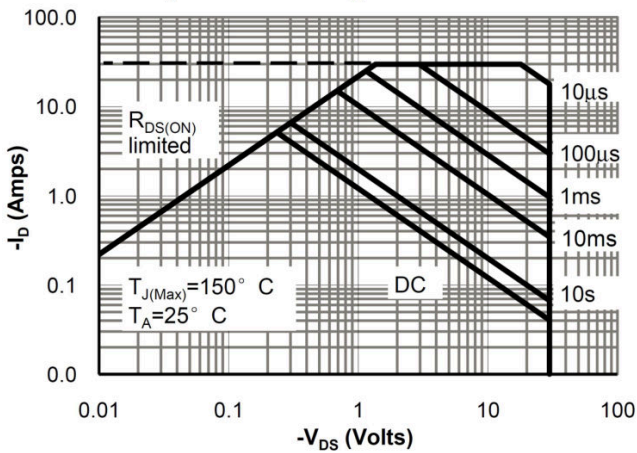

Figure 9: Maximum Forward Biased Safe Operating Area (Note F)

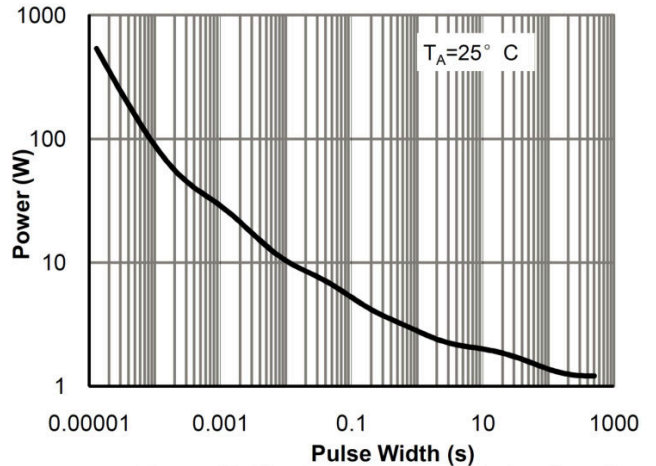

Figure 10: Single Pulse Power Rating Junction-to-Ambient (Note F)

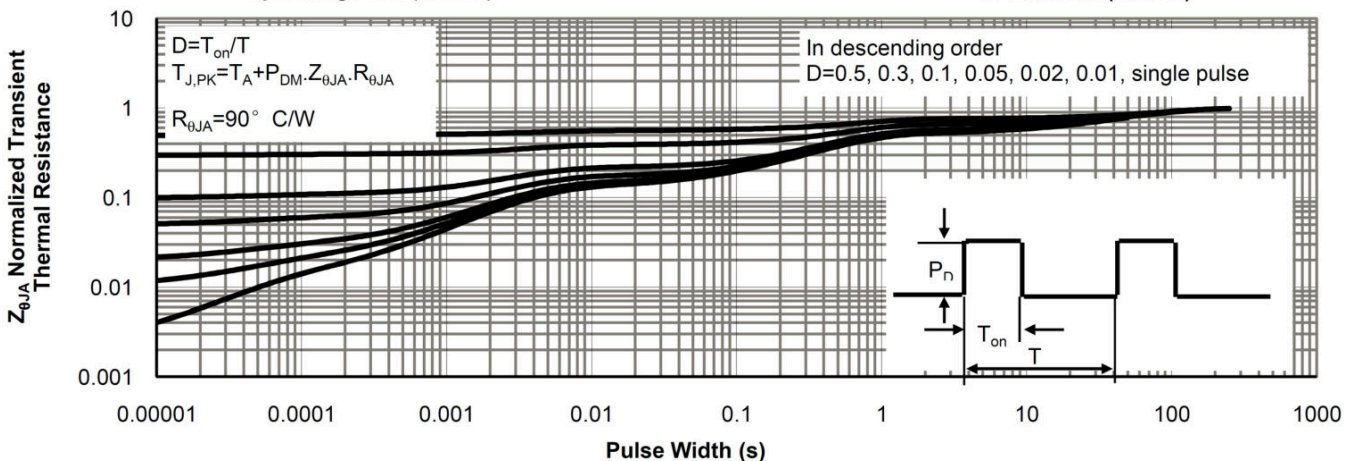
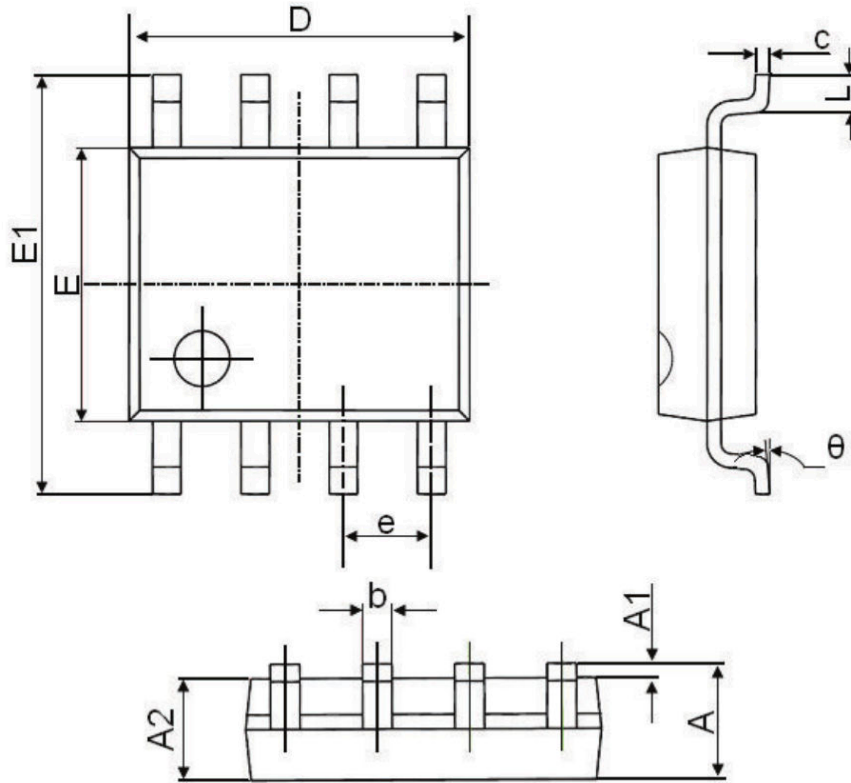

Figure 11: Normalized Maximum Transient Thermal Impedance (Note F)

SOP-8 Package Information



Symbol	Dimensions In Millimeters		Dimensions In Inches	
	Min.	Max.	Min.	Max.
A	1.350	1.750	0.053	0.069
A1	0.100	0.250	0.004	0.010
A2	1.350	1.550	0.053	0.061
b	0.330	0.510	0.013	0.020
c	0.170	0.250	0.006	0.010
D	4.700	5.100	0.185	0.200
E	3.800	4.000	0.150	0.157
E1	5.800	6.200	0.228	0.244
e	1.270(BSC)		0.050(BSC)	
L	0.400	1.270	0.016	0.050
θ	0°	8°	0°	8°

X-ON Electronics

Largest Supplier of Electrical and Electronic Components

Click to view similar products for [MOSFET](#) category:

Click to view products by [AnBon](#) manufacturer:

Other Similar products are found below :

[614233C](#) [648584F](#) [MCH3443-TL-E](#) [MCH6422-TL-E](#) [FDPF9N50NZ](#) [FW216A-TL-2W](#) [FW231A-TL-E](#) [APT5010JVR](#) [NTNS3A92PZT5G](#)
[IRF100S201](#) [JANTX2N5237](#) [2SK2464-TL-E](#) [2SK3818-DL-E](#) [FCA20N60_F109](#) [FDZ595PZ](#) [STD6600NT4G](#) [FSS804-TL-E](#) [2SJ277-DL-E](#)
[2SK1691-DL-E](#) [2SK2545\(Q,T\)](#) [D2294UK](#) [405094E](#) [423220D](#) [MCH6646-TL-E](#) [TPCC8103,L1Q\(CM](#) [367-8430-0972-503](#) [VN1206L](#)
[424134F](#) [026935X](#) [051075F](#) [SBVS138LT1G](#) [614234A](#) [715780A](#) [NTNS3166NZT5G](#) [751625C](#) [873612G](#) [IRF7380TRHR](#)
[IPS70R2K0CEAKMA1](#) [RJK60S3DPP-E0#T2](#) [RJK60S5DPK-M0#T0](#) [APT5010JVFR](#) [APT12031JFLL](#) [APT12040JVR](#) [DMN3404LQ-7](#)
[NTE6400](#) [JANTX2N6796U](#) [JANTX2N6784U](#) [JANTXV2N5416U4](#) [SQM110N05-06L-GE3](#) [SIHF35N60E-GE3](#)