

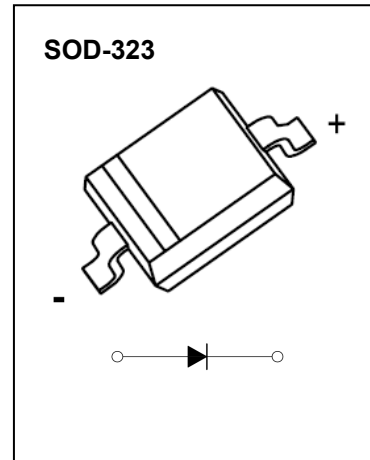

### FEATURES

- Low Forward Voltage Drop
- Fast Switching Time
- Surface Mount Package Ideally Suited for Automatic Insertion

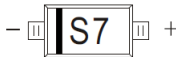

### MARKING:

BAT42WS	BAT43WS
	

### Maximum Ratings and Electrical Characteristics, Single Diode @Ta=25°C

Parameter	Symbol	Limit	Unit
Peak Repetitive Peak Reverse Voltage	$V_{RRM}$	30	V
Working Peak Reverse Voltage	$V_{RWM}$		
DC Blocking Voltage	$V_R$		
RMS Reverse Voltage	$V_{R(RMS)}$	21	V
Forward Continuous Current	$I_{FM}$	200	mA
Repetitive Peak Forward Current @t<1.0s	$I_{FRM}$	500	mA
Non-repetitive Peak Forward Surge Current @t=8.3ms	$I_{FSM}$	4.0	A
Power Dissipation	$P_d$	200	mW
Thermal Resistance Junction to Ambient	$R_{\theta JA}$	500	°C/W
Junction temperature	$T_J$	125	°C
Storage Temperature	$T_{STG}$	-55~+150	°C

### Electrical Ratings @Ta=25°C

Parameter	Symbol	Min	Typ	Max	Unit	Conditions
Reverse breakdown voltage	$V_{(BR)}$	30			V	$I_R=10\mu A$
Forward voltage	Both Types			1.0	V	$I_F=200mA$
	BAT42WS			0.4	V	$I_F=10mA$
	BAT42WS			0.65	V	$I_F=50mA$
	BAT43WS	0.26		0.33	V	$I_F=2mA$
	BAT43WS			0.45	V	$I_F=15mA$
Reverse current	$I_R$			0.5	$\mu A$	$V_R=25V$
Capacitance between terminals	$C_T$			10	pF	$V_R=1.0V, f=1.0MHz$
Reverse recovery time	$t_{rr}$			5	ns	$I_F=I_R=10mA$ $I_{rr}=0.1 \times I_R, R_L=100\Omega$

## Typical Characteristics

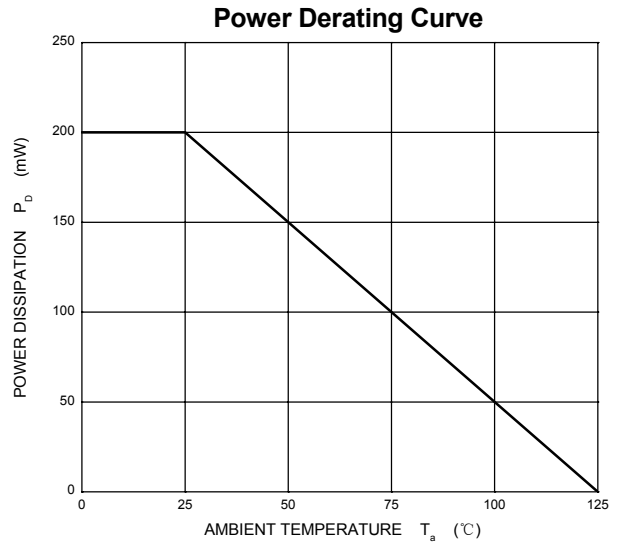
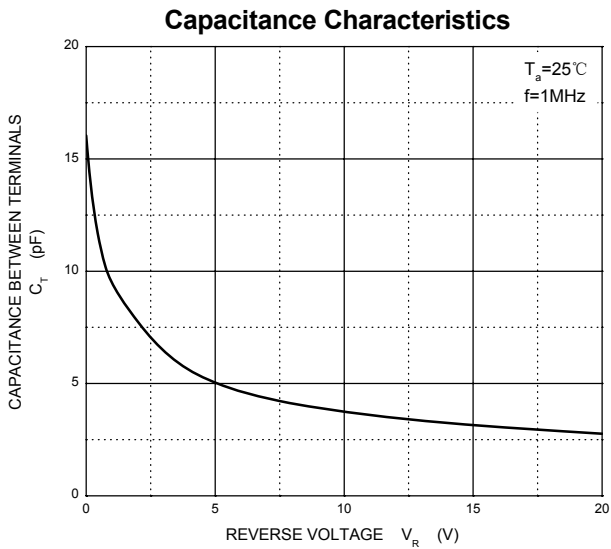
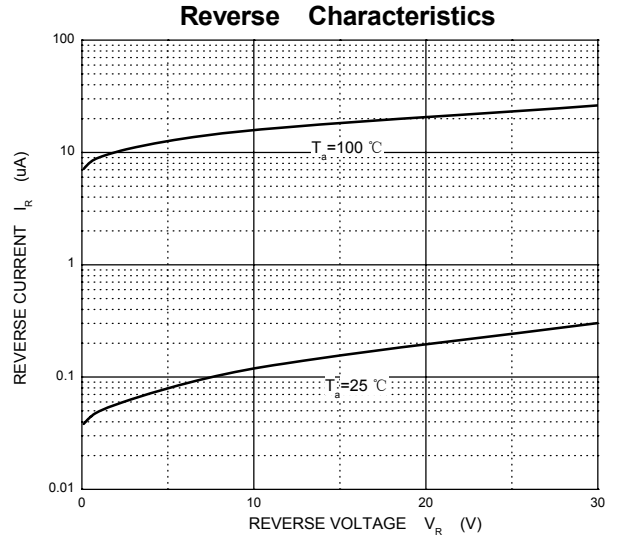
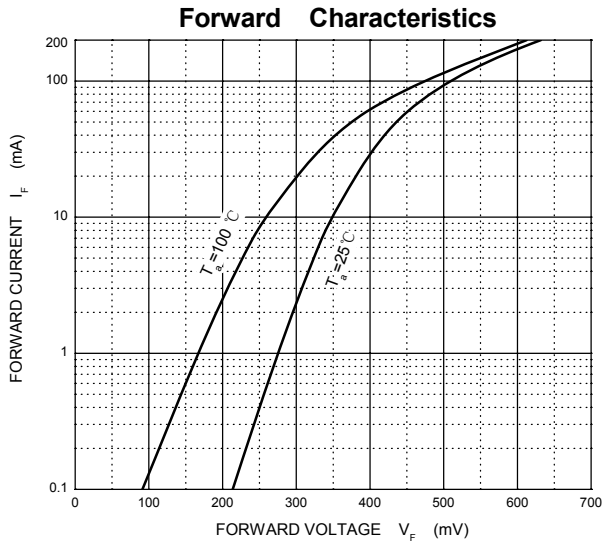

### SOD-323 Package Outline Dimensions

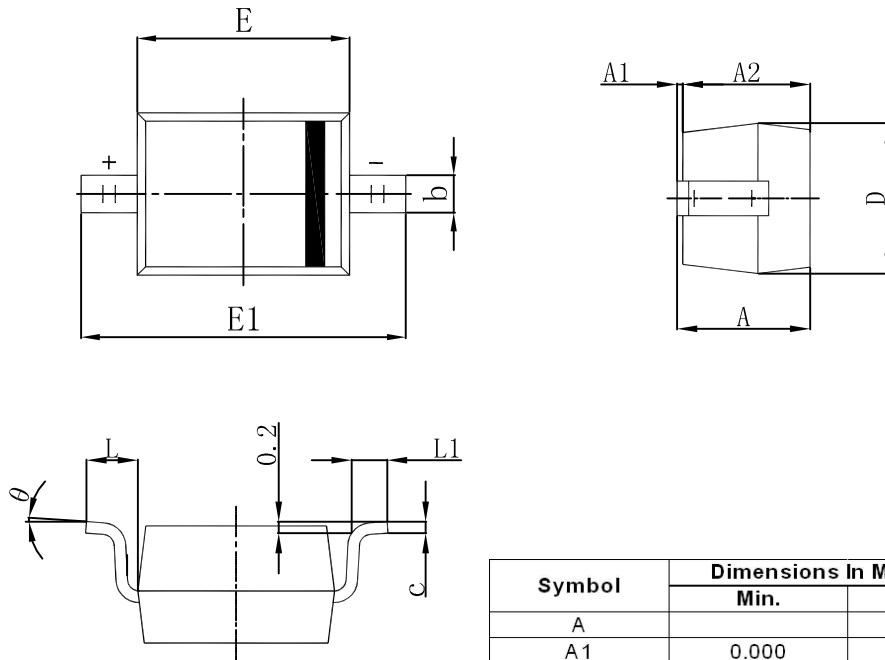

Symbol	Dimensions In Millimeters		Dimensions In Inches	
	Min.	Max.	Min.	Max.
A		1.000		0.039
A1	0.000	0.100	0.000	0.004
A2	0.800	0.900	0.031	0.035
b	0.250	0.350	0.010	0.014
c	0.080	0.150	0.003	0.006
D	1.200	1.400	0.047	0.055
E	1.600	1.800	0.063	0.071
E1	2.550	2.750	0.100	0.108
L	0.475 REF.		0.019 REF.	
L1	0.250	0.400	0.010	0.016
$\theta$	0°	8°	0°	8°

### SOD-323 Suggested Pad Layout

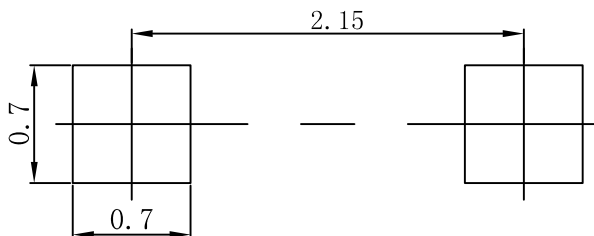

**Note:**

1. Controlling dimension: in millimeters.
2. General tolerance:  $\pm 0.05\text{mm}$ .
3. The pad layout is for reference purposes only.

## X-ON Electronics

Largest Supplier of Electrical and Electronic Components

*Click to view similar products for [Schottky Diodes & Rectifiers](#) category:*

*Click to view products by [AnBon](#) manufacturer:*

Other Similar products are found below :

[CUS06\(Te85L,Q,M\)](#) [MA4E2039](#) [D1FH3-5063](#) [MBR0530L-TP](#) [MBR10100CT-BP](#) [MBR30H100MFST1G](#) [MMBD301M3T5G](#) [PMAD1103-LF](#) [PMAD1108-LF](#) [RB160M-50TR](#) [RB520S-30](#) [RB551V-30](#) [DD350N18K](#) [DZ435N40K](#) [DZ600N16K](#) [BAS16E6433HTMA1](#) [BAS 3010S-02LRH E6327](#) [BAT 54-02LRH E6327](#) [IDL02G65C5XUMA1](#) [NSR05F40QNXT5G](#) [NSVR05F40NXT5G](#) [JANS1N6640](#) [SB07-03C-TB-H](#) [SB1003M3-TL-W](#) [SBAT54CWT1G](#) [SBM30-03-TR-E](#) [SBS818-TL-E](#) [SK32A-LTP](#) [SK33A-TP](#) [SK34A-TP](#) [SK34B-TP](#) [SMD1200PL-TP](#) [ACDBN160-HF](#) [SS3003CH-TL-E](#) [STPS30S45CW](#) [PDS3100Q-7](#) [GA01SHT18](#) [CRS10I30A\(Te85L,QM\)](#) [MBR1240MFST1G](#) [MBRB30H30CT-1G](#) [BAS28E6433HTMA1](#) [BAS 70-02L E6327](#) [HSB123JTR-E](#) [JANTX1N5712-1](#) [VS-STPS40L45CW-N3](#) [DD350N12K](#) [SB007-03C-TB-E](#) [SB10015M-TL-E](#) [SB1003M3-TL-E](#) [SK110-LTP](#)