

Features

- Small body outline dimensions
- Low body height
- Stand off voltage: 3.3V,5.0V,7.0V,12V
- Peak power up to 200 Watts @ 8 x 20us Pulse
- Low leakage
- Response time is typically < 1 ns
- Provide transient protection:
IEC 61000-4-2 (ESD) level 4
IEC 61000-4-4 (EFT) 40A (5/50ns)
IEC 61000-4-5 (Surge) (8/20us)
- Lead-free parts meet RoHS requirements.
- Suffix "-H" indicates Halogen-free part, ex.ESD5Z3V3-H

Applications

- Cellular phones
- Portable devices
- Digital cameras
- Power supplies

Mechanical data

- Epoxy:UL94-V0 rated flame retardant
- Case : Molded plastic, SOD-523
- Terminals : Solder plated, solderable per MIL-STD-750, Method 2026
- Polarity : Indicated by cathode band
- Mounting Position : Any

Package outline

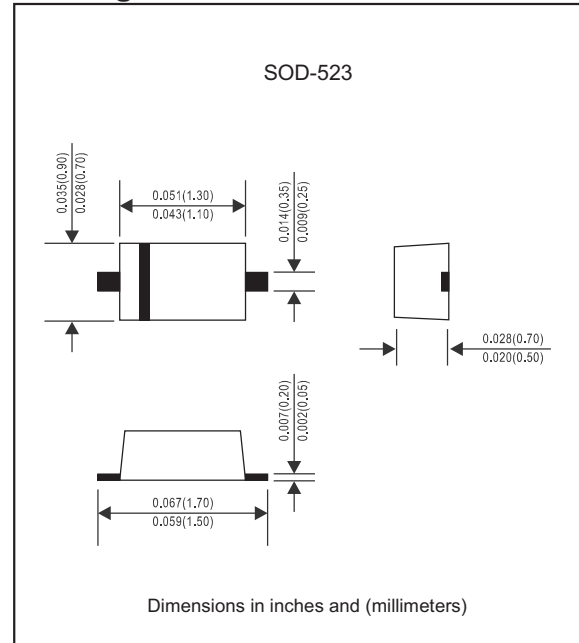

Maximum ratings (at $T_A=25^\circ\text{C}$ unless otherwise noted)

PARAMETER	CONDITIONS	Symbol	Value	UNIT
Total power dissipation	Peak pulse power ($t_p = 8/20\mu\text{s}$)	P_{PP}	200	W
Electrostatic discharge	IEC61000-4-2 air discharge IEC61000-4-2 contact discharge	E_{SD}	± 15 ± 8	kV
ESD voltage	Per human body model	E_{SD}	16	kV
Electrostatic discharge	IEC61000-4-4	E_{FT}	40	A
Lead solder temperature-maximum	10 second duration	T_L	260	$^\circ\text{C}$
Maximum junction temperature		T_J	+150	$^\circ\text{C}$
Storage temperature range		T_{STG}	-55~+150	$^\circ\text{C}$
Operating temperature range		T_{OP}	-40~+125	$^\circ\text{C}$

Electrical characteristics (at $T_A=25^\circ\text{C}$ unless otherwise noted, $V_F = 0.9\text{V}$ Max. @ $I_F=10\text{mA}$ for all types)

Part No.	V_{RWM} (V)	I_R (μA) @ V_{RWM}	V_{BR} (V)@ I_T (Note 2)	I_T (mA)	V_C (V)(Note 1) @ $I_{PP}=5.0\text{A}$	I_{PP} (A) (Note 1)	V_C (V)(Note 1) @ Max I_{PP}	P_{PK} (W) (Note 1) Max.	C_J (pF) $V_R=0\text{V}$ and $f=1\text{MHz}$ Typ.
	Max.	Max.	Min.		Max.	Max.	Max.		
ESD5Z3.3	3.3	1.0	5.0	1.0	8.4	11.2	14.1	158	105
ESD5Z5.0	5.0	1.0	6.2	1.0	11.6	9.4	18.6	174	80
ESD5Z7.0	7.0	1.0	7.5	1.0	13.5	8.8	22.7	200	65
ESD5Z12	12.0	1.0	13.5	1.0	17.0	9.6	25.0	240	55

Note 1. Surge current waveform per Fig.1

2. V_{BR} is measured with a pulse test current I_T at an ambient temperature of 25°C .

Typical characteristics (at $T_A=25^\circ\text{C}$ unless otherwise noted)

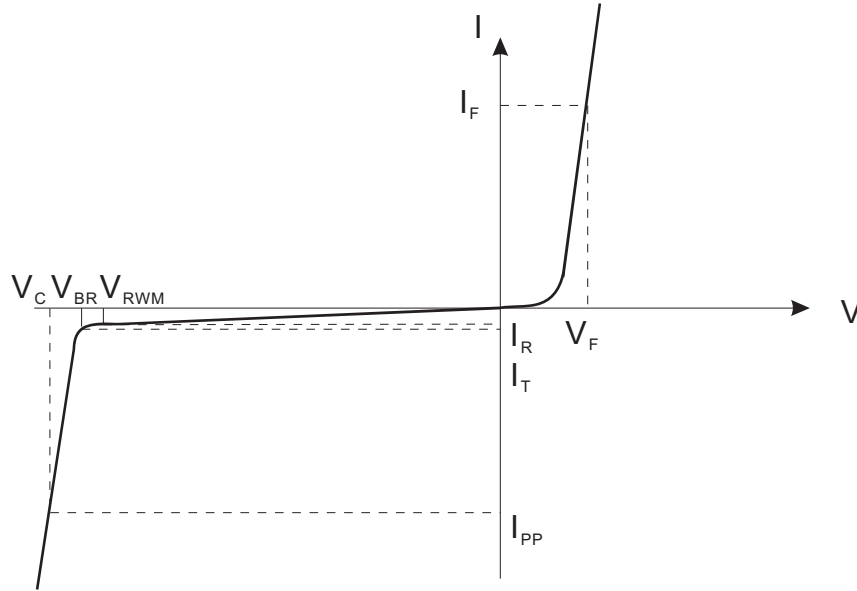

Uni-Directional TVS

- V_C : Clamping Voltage @ I_{PP}
- I_{PP} : Maximum Reverse Peak Pulse Current
- V_{RWM} : Maximum Working Peak Reverse voltage
- I_R : Maximum Reverse Leakage Current @ V_{RWM}
- V_{BR} : Breakdown voltage @ I_T
- I_T : Test Current
- I_F : Forward Current
- V_F : Forward Voltage @ I_F
- C_J : Capacitance @ $V_R = 0\text{V}$ and $f = 1\text{MHz}$

Rating and characteristic curves (ESD5Z SERIES)

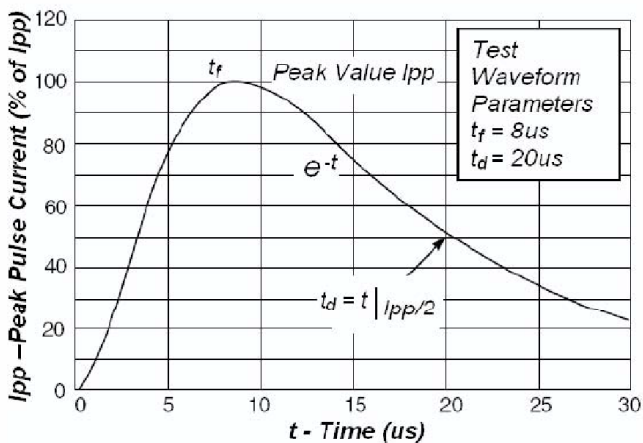

Fig1. Pulse Waveform

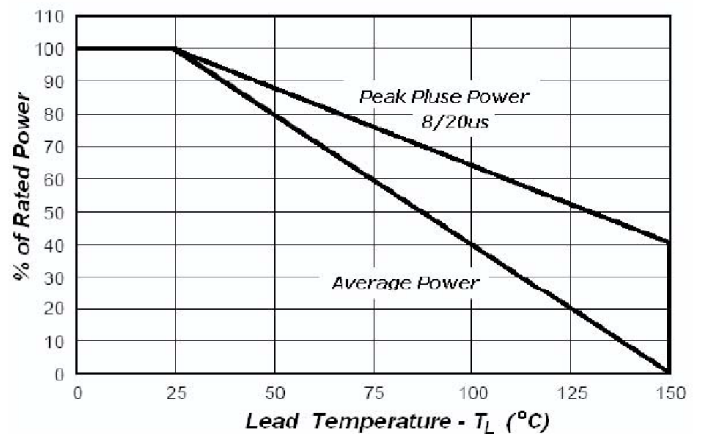
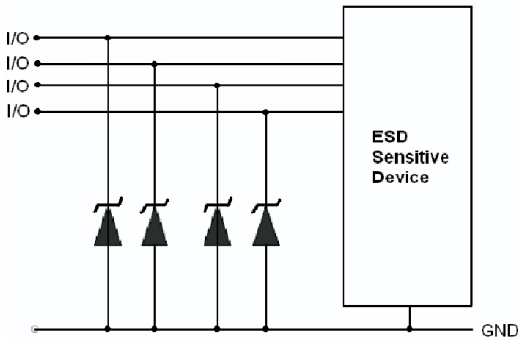

Fig2. Power Derating

Application Note

Electrostatic discharge (ESD) is a major cause of failure in electronic system. Transient Voltage Suppressors (TVS) are an ideal choice for ESD protection. They are capable of clamping the incoming transient to a low enough level such that damage to the protected semiconductor is prevented. Surface mount TVS offers the best choice for minimal lead inductance. They serve as parallel protection elements, connected between the signal lines to ground. As the transient rise above the operating voltage of the device, the TVS becomes a low impedance path diverting the transient current to ground. The ESD5Z Series is the ideal board level protection of ESD sensitive semiconductor components. The tiny SOD-523 package allows design flexibility in the design of high density boards where the space is at a premium. This enables to shorten the routing and contributes to hardening against ESD.



Pinning information

Pin	Simplified outline	Symbol
Pin1 cathode Pin2 anode		

Marking

Type number	Marking code
ESD5Z3.3	ZE
ESD5Z5.0	ZF
ESD5Z7.0	ZH
ESD5Z12	ZM

Suggested solder pad layout

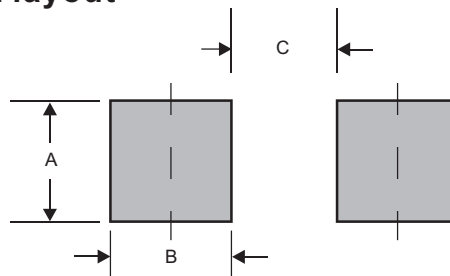

Dimensions in inches and (millimeters)

PACKAGE	A	B	C
SOD-523	0.032 (0.80)	0.024 (0.60)	0.044 (1.10)

Packing information

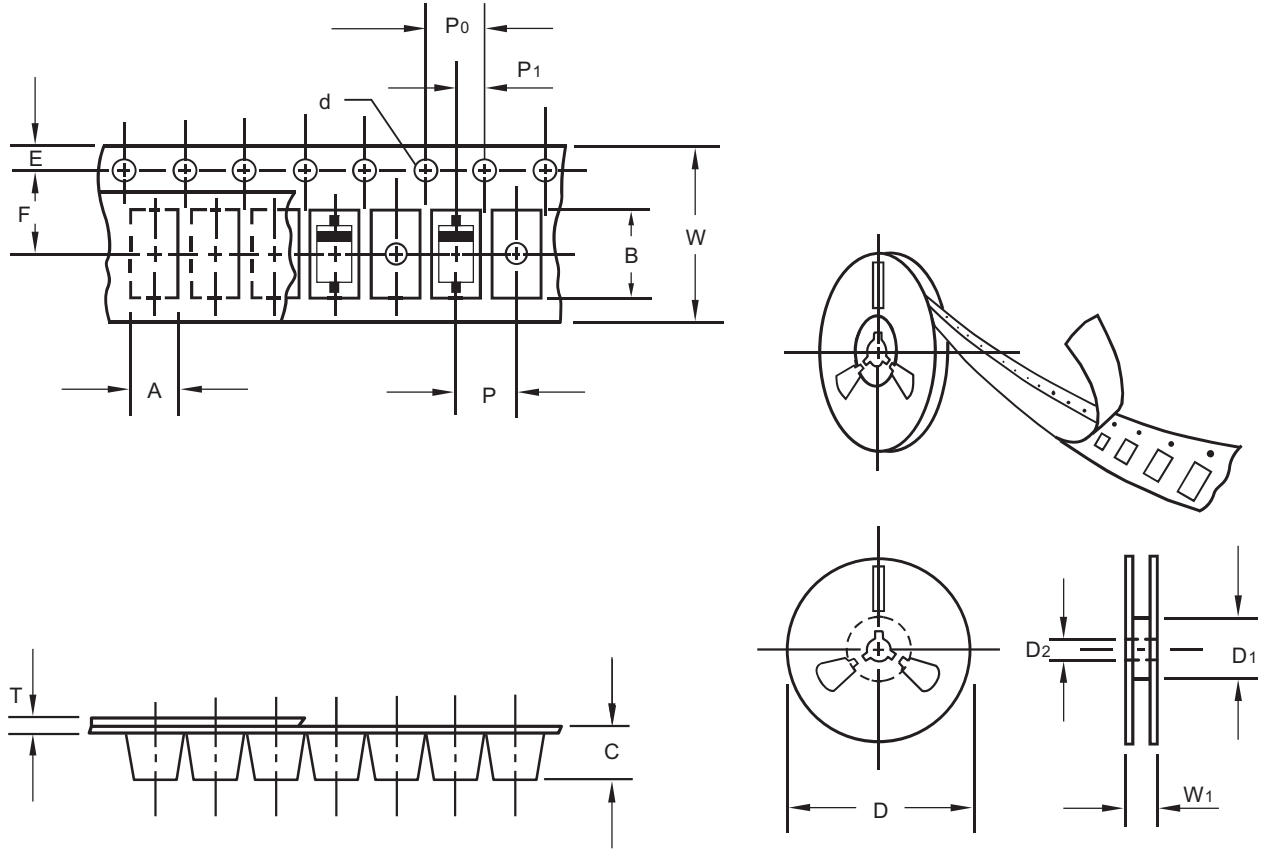

unit:mm

Item	Symbol	Tolerance	SOD-523
Carrier width	A	0.05	0.96
Carrier length	B	0.05	1.94
Carrier depth	C	0.1	0.76
Sprocket hole	d	0.1	1.50
7" Reel outside diameter	D	1.0	178.00
7" Reel inner diameter	D ₁	0.4	54.40
Feed hole diameter	D ₂	0.05	1.30
Sprocket hole position	E	0.01	1.75
Punch hole position	F	0.05	3.50
Punch hole pitch	P	0.05	2.00
Sprocket hole pitch	P ₀	0.1	4.00
Embossment center	P ₁	0.05	2.00
Overall tape thickness	T	0.02	0.18
Tape width	W	0.4	8.00
Reel width	W ₁	0.2	12.30

Note: Devices are packed in accordance with EIA standard RS-481-A and specifications listed above.

Reel packing

PACKAGE	REEL SIZE	REEL (pcs)	COMPONENT SPACING (m/m)	BOX (pcs)	INNER BOX (m/m)	REEL DIA. (m/m)	CARTON SIZE (m/m)	CARTON (pcs)	APPROX. GROSS WEIGHT (kg)
SOD-523	7"	3,000	2.0	30,000	183*123*183	178	382*257*387	240,000	9.5

Suggested thermal profiles for soldering processes

- 1.Storage environment: Temperature=5°C~40°C Humidity=55%±25%
- 2.Reflow soldering of surface-mount devices

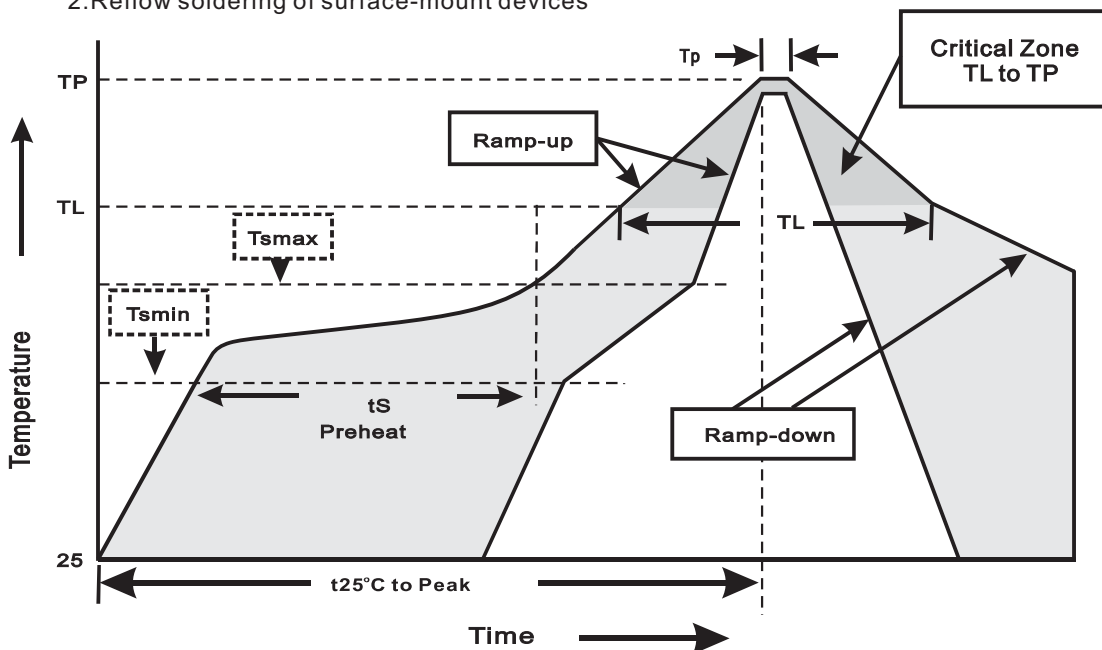

3.Reflow soldering

Profile Feature	Soldering Condition
Average ramp-up rate(TL to TP)	<3°C/sec
Preheat -Temperature Min(Tsmin) -Temperature Max(Tsmax) -Time(min to max)(ts)	150°C 200°C 60~120sec
Tsmax to TL -Ramp-upRate	<3°C/sec
Time maintained above: -Temperature(TL) -Time(tL)	217°C 60~260sec
Peak Temperature(TP)	255°C-0/+5°C
Time within 5°C of actual Peak Temperature(tp)	10~30sec
Ramp-down Rate	<6°C/sec
Time 25°C to Peak Temperature	<6minutes

X-ON Electronics

Largest Supplier of Electrical and Electronic Components

Click to view similar products for [ESD Suppressors / TVS Diodes](#) category:

Click to view products by [AnBon](#) manufacturer:

Other Similar products are found below :

[NTE4902](#) [P4SMAJ15A](#) [P4SMAJ26A](#) [SMAJ400CA-TP](#) [TGL34-47CA](#) [ESDAULC45-1BF4](#) [SM1605E3/TR13](#) [SMF20A-TP](#) [P4SMAJ12A](#)
[CPDUR24V-HF](#) [CPDQC5V0USP-HF](#) [CPDQC5V0-HF](#) [MPLAD30KP45CAE3](#) [MMBZ27VCLQ-7-F](#) [MMAD1108/TR13](#) [MPLAD30KP24A](#)
[ACPDQC5V0R-HF](#) [DFLT170A-7](#) [NTE4900](#) [NTE4926](#) [NTE4938](#) [SMF22A-TP](#) [SMF12A-TP](#) [SLVU2.8-TP](#) [SMLJ6.5CA-TP](#) [SMAJ6.5CA-](#)
[TP](#) [MMAD1108E3/TR13](#) [D5V0M1U2LP3-7](#) [SMAJ400A-TP](#) [AOZ8811DT-03](#) [AOZ8831DI-05](#) [AOZ8831DT-03](#) [SMAJ188CA](#) [3SMC33CA](#)
[BK](#) [CPDQC3V3C-HF](#) [CPDQC12VE-HF](#) [MPLAD30KP170CA](#) [82357120100](#) [5.0SMLJ15CA-TP](#) [5KP18A-TP](#) [P6KE8.2A-TP](#)
[MPLAD30KP43CAE3](#) [SMAJ43A-TP](#) [D5V0F6U8LP33-7](#) [TVS5501V10MUT5G](#) [5.0SMLJ24CA-TP](#) [SMAJ110CA-TP](#) [MPLAD15KP75CAE3](#)
[MMAD1103e3/TR13](#) [DFLT40AQ-7](#)