

## FEATURES

- Small surface mounting type
- High reliability

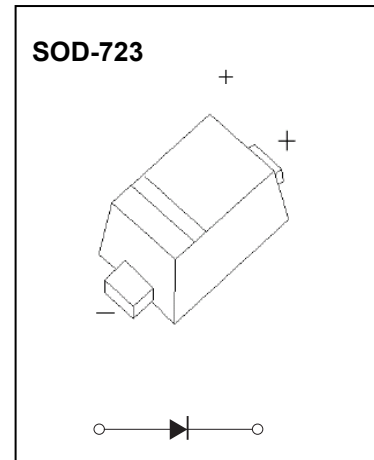

## MARKING: F



## Maximum Ratings and Electrical Characteristics, Single Diode @Ta=25°C

Parameter	Symbol	Limit	Unit
DC reverse voltage	$V_R$	30	V
Mean rectifying current	$I_O$	200	mA
Non-repetitive Peak forward surge current @ t=8.3ms	$I_{FSM}$	1	A
Power dissipation	$P_D$	100	mW
Thermal Resistance Junction to Ambient	$R_{\theta JA}$	1000	°C/W
Junction temperature	$T_j$	125	°C
Storage temperature	$T_{stg}$	-55~+150	°C

## Electrical Ratings @Ta=25°C

Parameter	Symbol	Min	Typ	Max	Unit	Conditions
Forward voltage	$V_{F1}$			0.35	V	$I_F=10mA$
	$V_{F2}$			0.5	V	$I_F=200mA$
Reverse current	$I_R$			10	$\mu A$	$V_R=10V$

## Typical Characteristics

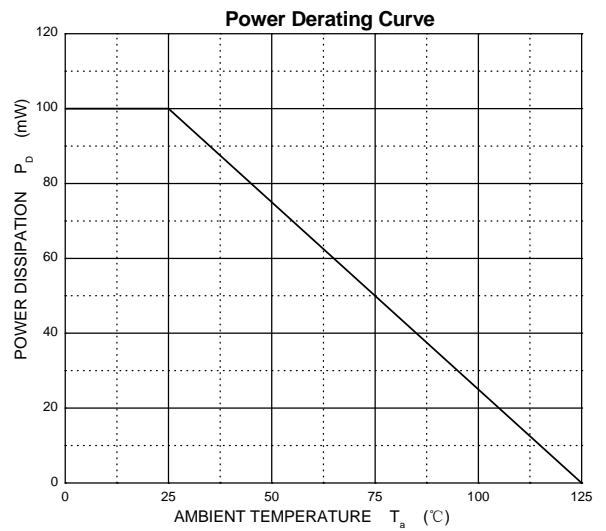
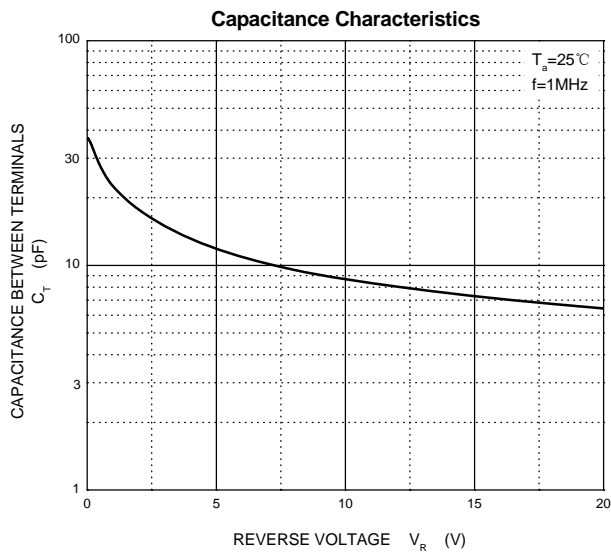
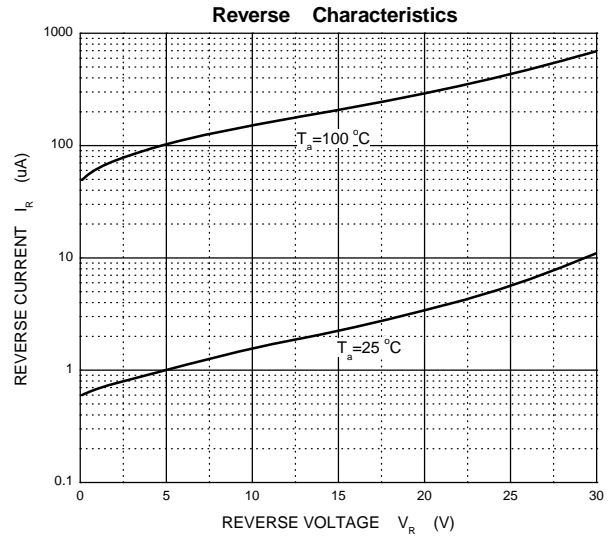
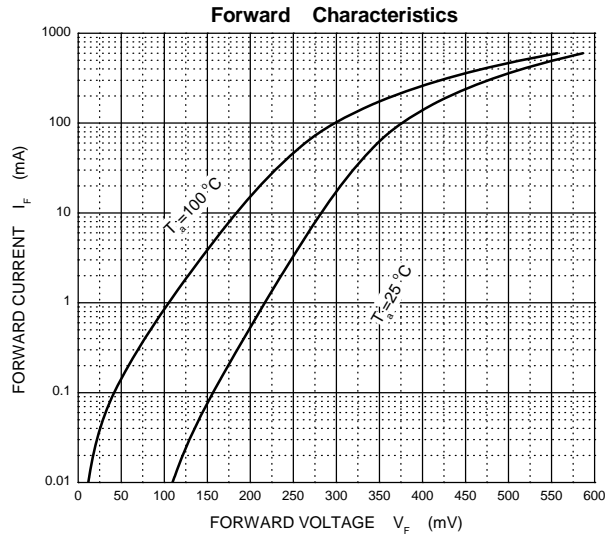

## SOD-723 Package Outline Dimensions

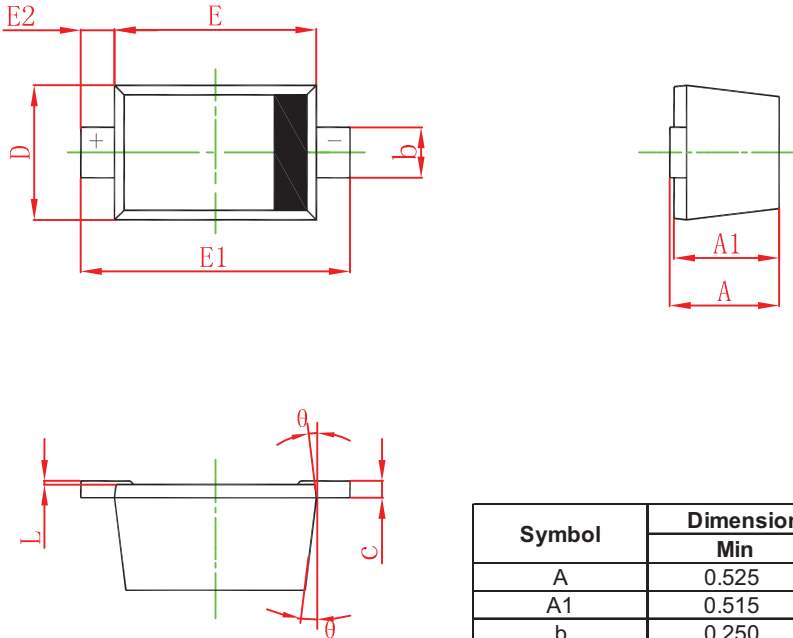

Symbol	Dimensions In Millimeters		Dimensions In Inches	
	Min	Max	Min	Max
A	0.525	0.650	0.021	0.026
A1	0.515	0.580	0.020	0.023
b	0.250	0.350	0.010	0.014
c	0.080	0.150	0.003	0.006
D	0.550	0.650	0.022	0.026
E	0.900	1.100	0.035	0.043
E1	1.300	1.500	0.051	0.059
E2	0.200 REF		0.008 REF	
L	0.010	0.070	0.001	0.003
$\theta$	7° REF		7° REF	

## SOD-723 Suggested Pad Layout

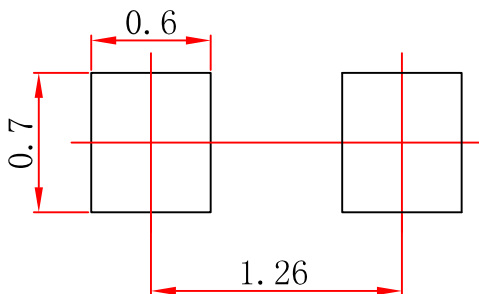

**Note:**

1. Controlling dimension: in millimeters.
2. General tolerance:  $\pm 0.05\text{mm}$ .
3. The pad layout is for reference purposes only.

## X-ON Electronics

Largest Supplier of Electrical and Electronic Components

*Click to view similar products for [anbon manufacturer](#):*

Other Similar products are found below :

[AU6N70S](#) [MBR2045CT](#) [AU10N65S](#) [GBU810](#) [AS2312](#) [AS2102W](#) [RB706F-40](#) [AS3442](#) [SMAJ7.5CA](#) [SMF5.0A](#) [SMBJ200A](#) [SMAJ30A](#)  
[BAV99](#) [DSK14](#) [BSS123](#) [SMAJ17CA](#) [SMBJ14CA](#) [AU4N60S](#) [AF8N60S](#) [SMAJ13CA](#) [SMAJ48A](#) [SL24-F](#) [SMF28CA](#) [GBU1010](#) [2SC3356](#)  
[SMBJ24CA](#) [SMCJ12A](#) [AS3418](#) [SMF8.0CA](#) [SMAJ26A](#) [SMF36A](#) [SMBJ48A](#) [KBL410](#) [AS2341](#) [DSK26](#) [SMF48CA](#) [AS3523](#) [BC807-25](#)  
[SMBJ10A](#) [MURS260-B](#) [SMAJ12A](#) [SMBJ43CA](#) [BAT43WS](#) [SS26-B](#) [SMF10CA](#) [SMAJ10CA](#) [SMAJ12CA](#) [BZT52C5V1S](#) [AS3100](#)  
[SMF40CA](#)