

### Features

- Batch process design, excellent power dissipation offers better reverse leakage current and thermal resistance.
- Low profile surface mounted application in order to optimize board space.
- Low power loss, high efficiency.
- High current capability, low forward voltage drop.
- High surge capability.
- Guardring for overvoltage protection.
- Ultra high-speed switching.
- Silicon epitaxial planar chip, metal silicon junction.
- Lead-free parts meet environmental standards of MIL-STD-19500 /228
- Compliant to Halogen-free.

### Mechanical data

- Epoxy:UL94-V0 rated flame retardant
- Case : TO-277B , molded Plastic
- Terminals:Solderable per MIL-STD-750,Method 2026
- Marking:Pages 3

### Package outline

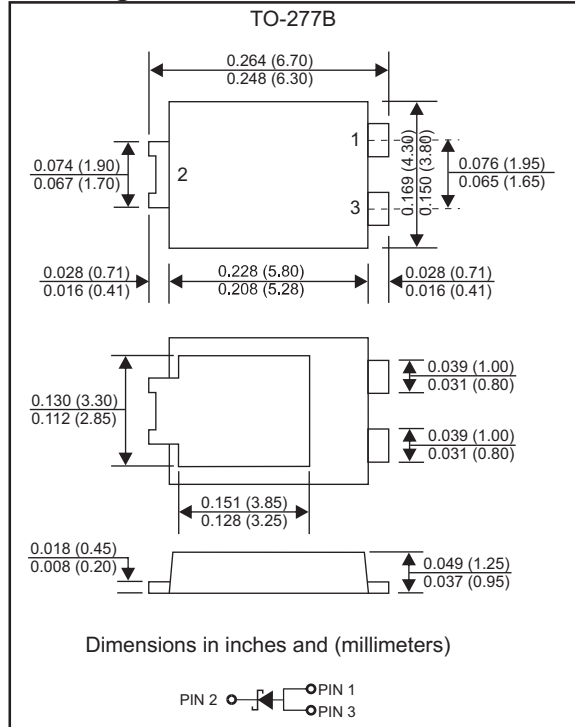

### Maximum ratings and Electrical Characteristics (AT $T_A=25^{\circ}\text{C}$ unless otherwise noted)

PARAMETER	CONDITIONS	Symbol	MIN.	TYP.	MAX.	UNIT
Forward rectified current	See Fig.1	$I_O$			5.0	A
Forward surge current	8.3ms single half sine-wave (JEDEC methode)	$I_{FSM}$			120	A
Reverse current	$V_R = V_{RRM} \quad T_J = 25^{\circ}\text{C}$	$I_R$			0.5	mA
	$V_R = V_{RRM} \quad T_J = 100^{\circ}\text{C}$				10	
Typical Thermal resistance	Junction to ambient	$R_{\theta JA}$		80		$^{\circ}\text{C/W}$
	Junction to lead	$R_{\theta JL}$		15		$^{\circ}\text{C/W}$
Storage temperature		$T_{STG}$	-65		+175	$^{\circ}\text{C}$

SYMBOLS	$V_{RRM}^{*1}$ (V)	$V_{RMS}^{*2}$ (V)	$V_R^{*3}$ (V)	$V_F^{*4}$ (V)	Operating temperature $T_J$ , ( $^{\circ}\text{C}$ )
SL5100-T	100	70	100	0.80	-55 to +150

\*1 Repetitive peak reverse voltage

\*2 RMS voltage

\*3 Continuous reverse voltage

\*4 Maximum forward voltage@ $I_F=5.0\text{A}$

## Rating and characteristic curves

FIG.1-TYPICAL FORWARD CURRENT DERATING CURVE

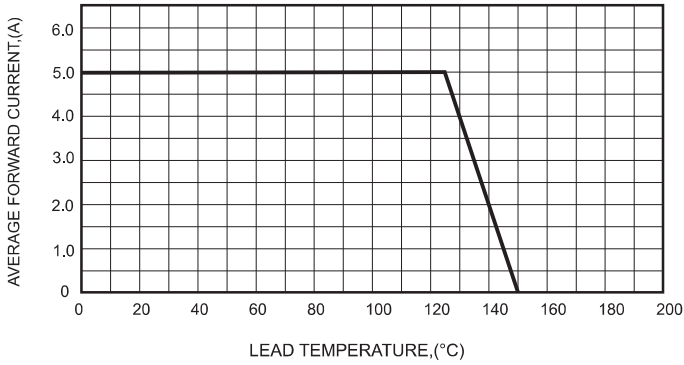

FIG.2-TYPICAL FORWARD CHARACTERISTICS

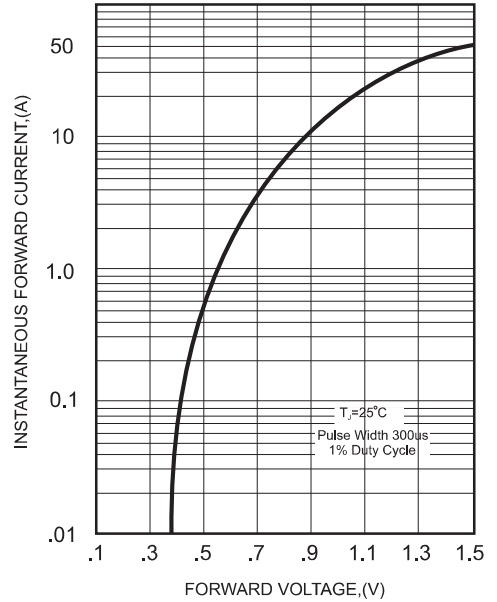

FIG.3-MAXIMUM NON-REPETITIVE FORWARD SURGE CURRENT

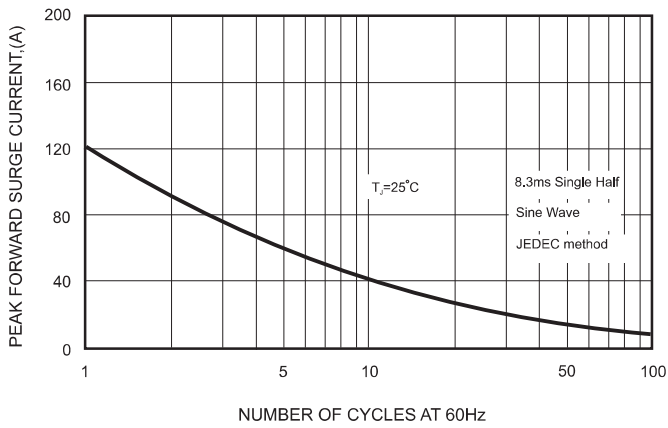
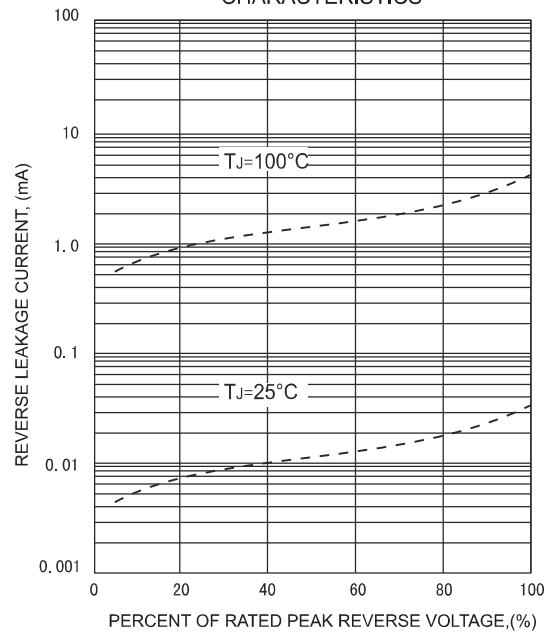

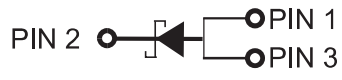

FIG.4 - TYPICAL REVERSE CHARACTERISTICS



### Pinning information

Pin	Simplified outline	Symbol
PIN 1 anode PIN 3 anode PIN 2 cathode		

### Marking

Type number	Marking code
SL5100-T	SL05100

### Suggested solder pad layout

TO-277B

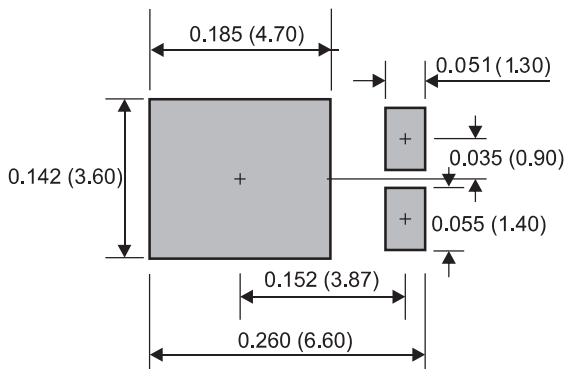

Dimensions in inches and (millimeters)

## X-ON Electronics

Largest Supplier of Electrical and Electronic Components

*Click to view similar products for [Schottky Diodes & Rectifiers](#) category:*

*Click to view products by [AnBon](#) manufacturer:*

Other Similar products are found below :

[MA4E2039](#) [MA4E2508M-1112](#) [MBR1545CT](#) [MMBD301M3T5G](#) [RB160M-50TR](#) [D83C](#) [BAS16E6433HTMA1](#) [BAT 54-02LRH E6327](#)  
[NRVBAF360T3G](#) [NSR05F40QNXT5G](#) [NTE555](#) [JANS1N6640](#) [SK310-T](#) [SK34B-TP](#) [SS3003CH-TL-E](#) [GA01SHT18](#)  
[CRS10I30A\(TE85L,QM](#) [MA4E2501L-1290](#) [MBRA140TRPBF](#) [MBRB30H30CT-1G](#) [BAT 15-04R E6152](#) [JANTX1N5712-1](#) [DMJ3940-000](#)  
[SB007-03C-TB-E](#) [SK33B-TP](#) [NRVBB20100CTT4G](#) [NRVBM120LT1G](#) [NTSB30U100CT-1G](#) [VS-6CWQ10FNHM3](#) [CRG04\(T5L,TEMQ\)](#)  
[ACDBA1100LR-HF](#) [ACDBA1200-HF](#) [ACDBA240-HF](#) [ACDBA3100-HF](#) [CDBQC0530L-HF](#) [CDBQC0240LR-HF](#) [ACDBA260LR-HF](#)  
[ACDBA1100-HF](#) [MA4E2502L-1246](#) [10BQ015-M3/5BT](#) [NRVBM120ET1G](#) [CRS08TE85LQM](#) [PMAD1108-LF](#) [B120Q-13-F](#) [1N5819T-G](#)  
[B0530WSQ-7-F](#) [PDS1040Q-13](#) [B160BQ-13-F](#) [SDM05U20CSP-7](#) [B140S1F-7](#)