

Powerpole® connectors provide cost-effective reliability, design flexibility and safety for your products' manufacture, installation and maintenance.

The housings are modular. They provide 600 Volts continuous, AC or DC operation. Wire sizes range from #14 to #16 AWG (2.1 to 1.3 mm²). Contacts are available in reeled and loose piece designs to support all production needs from engineering prototype, low volume and high volumes products.

FEATURES

- **Make-first/Break-last connection**

Provides safety and system integrity

- **Green housing**

Visual indication of ground terminal

- **Molded-in dovetails**

Can be assembled with standard Powerpole PP15, Powerpole PP30 and Powerpole PP45 connectors to make pre-grounded multipole configurations

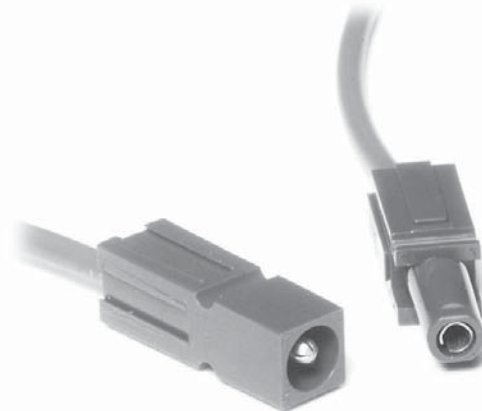

PRODUCT SPECIFICATIONS

Connector Model	PP10 P & S	Connector Model	PP10 P & S
UL Current Rating (Amperes)*	10*	No load (Contact/Disconnect Cycles)	To 250
UL Voltage Ratings (Volts)**	600*	Avg. Connection/Disconnect (lbf)	5
Contact Barrel Wire Size (AWG)	#14 to #16	Operating Temperature Range °C***	-20° to 105°
(mm ²)	2.1 to 1.3	°F	-4° to 221°
Maximum Wire Insulation Diameter (inches)	0.137	Flammability Rating of Housing Material	UL94 V-0
(mm)	3.48		
AVG Contact Resistance* (micro-ohms)	2200		
Insulation Withstanding Test Voltage (Volts AC/DC)	2200		
Contact Retention Force (lbf)	25		



* UL Rated for 65°C largest wire or cable size

** Both AC & DC Voltage

*** Contact factory for higher temperature rated connectors

ORDERING INFORMATION

Housing & 10 amp Contact

Part Number	Housing Color	Wire	
		AWG	sq. mm
1200G1	Socket, Green	14/16	2.1/1.3
1201G1	Pin, Green	14/16	2.1/1.3

Housings Only

Part Number	Description
1204G1	Green housing, socket
1205G1	Green housing, pin

Tooling

Part Number	Description
1309G1	Hand tool, #14 to #16
260G3	Applicator only (110V & 220V)
280G2	Applicator and press (110V, 60Hz)
250G1	Press only (110V, 60Hz)
250G2	Press only (220V, 50Hz)

10 amp Contacts

Part Number	Description	Wire	
		AWG	sq. mm
1202G1	Socket, Individual	14/16	2.1/1.3
264G1	Socket, Reel	14/16	2.1/1.3
1203G1	Pin, Individual	14/16	2.1/1.3
263G1	Pin, Reel	14/16	2.1/1.3

Note: For additional colors please contact customer service

HEADQUARTERS: Anderson Power Products®, 13 Pratts Junction Road, Sterling, MA 01564-2305 USA T:978-422-3600 F:978-422-3700

EUROPE: Anderson Power Products® Ltd., Unit 3, Europa Court, Europa Boulevard, Westbrook, Warrington, Cheshire, WA5 7TN United Kingdom T: +44 (0) 1925 428390 F: +44 (0) 1925 428399

ASIA / PACIFIC: IDEAL Anderson Asia Pacific Ltd., Unit 922-928 Topsail Plaza, 11 On Sum Street, Shatin N.T., Hong Kong T: +(852) 2636 0836 F: +(852) 2635 9036

CHINA: IDEAL Anderson Technologies (Shenzhen) Ltd., Block A8 Tantou Western Industrial Park, Songgang Baoan District, Shenzhen, P.R. China 518105 T: +(86) 755 2768 2118 F: +(86) 755 2768 2218

TAIWAN: IDEAL Anderson Asia Pacific Ltd., Taiwan Branch, 4F.-2, No.116, Dadun 20th St., Situn District, Taichung City 407, Taiwan (R.O.C.) T: +(886) 4 2310 6451 F: +(886) 4 2310 6460

www.andersonpower.com

DIMENSIONS

Housings

Series	-A-		-B-		-C-		-D-	
	mm	in.	mm	in.	mm	in.	mm	in.
PP10 Pin	7.9	0.31	7.9	0.31	24.5	0.97	41.3	1.63
PP10 Socket	7.9	0.31	7.9	0.31	27.5	1.081	41.3	1.63

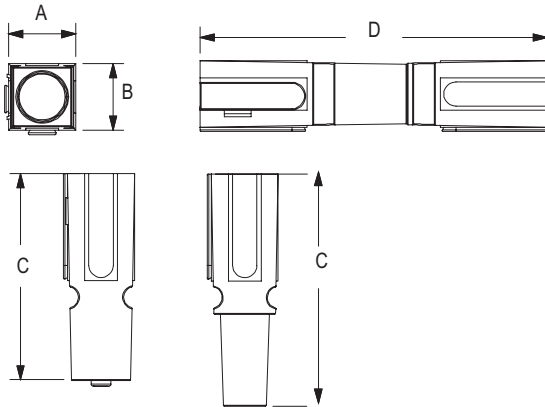

Contacts

Series	-A-		-B-	
	mm	in.	mm	in.
PP10 Pin	22.4	0.88	2.4	0.093 - OD
PP10 Socket	22.4	0.88	2.3	0.089 - ID

Socket Contact

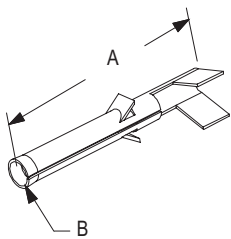

Pin Contact

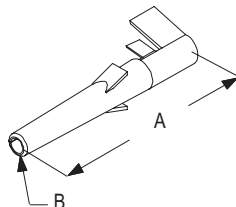

TEMPERATURE RISE CHARTS

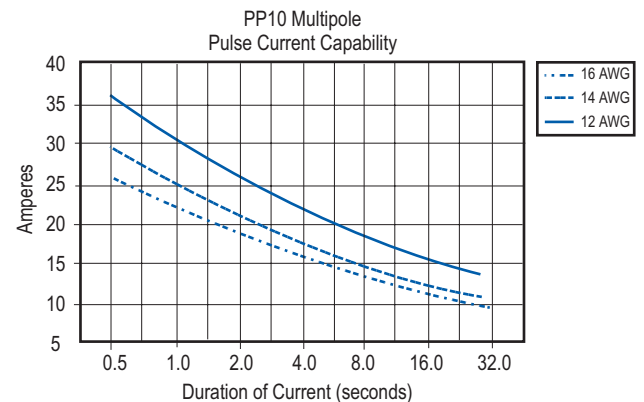
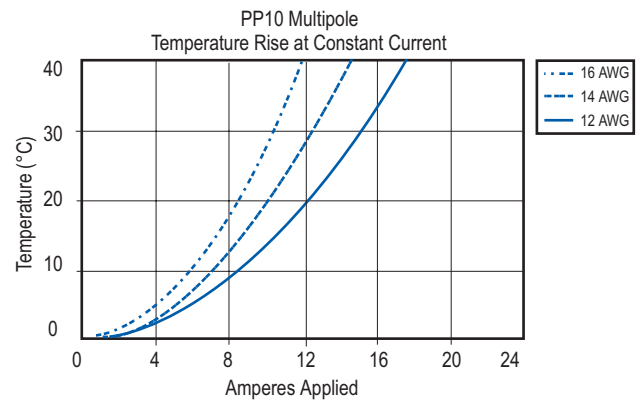
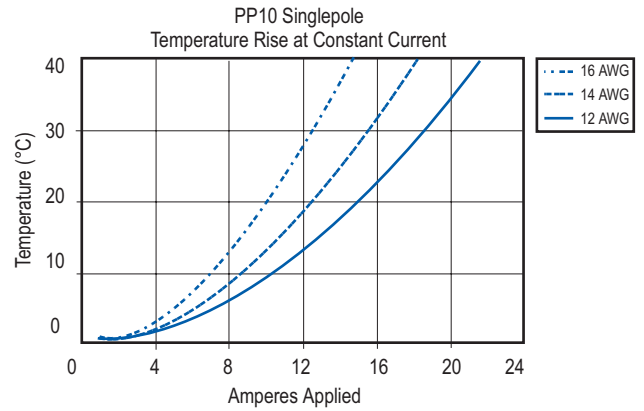

X-ON Electronics

Largest Supplier of Electrical and Electronic Components

Click to view similar products for [Crimpers / Crimping Tools](#) category:

Click to view products by [Anderson Power Products](#) manufacturer:

Other Similar products are found below :

[010-0096](#) [M225202-37](#) [6-1579015-5](#) [CT150-2-D02](#) [M322](#) [6-304052-1](#) [63456-0054](#) [63484-3701](#) [63800-8355](#) [63819-1875](#) [63819-2875](#)
[63819-4475](#) [63823-3475](#) [63827-5375](#) [64001-0975](#) [64001-4175](#) [64005-0175](#) [662903-2](#) [690602-6](#) [7-1579001-9](#) [7-23471-1](#) [762637-1](#) [808714-](#)
[1](#) [811242-5](#) [999-50-020083](#) [1-21002-3](#) [1-21002-7](#) [12085270](#) [1-21002-6](#) [1-21113-6](#) [1-22548-4](#) [125442-1](#) [DCE.91.073.BVC](#)
[DCE.91.090.3MVM](#) [DCE.91.130.5MVU](#) [DCE.91.202.BVCM](#) [1338300-1](#) [1-354003-0](#) [1338301-1](#) [DF62/RE-MD](#) [142321](#) [1456088-1](#)
[1490794-1](#) [1-45804-6](#) [1490357-2](#) [1490357-3](#) [AX100749](#) [1-59619-7](#) [1596970-1](#) [1-59619-8](#)