

6 POSITION SPEC Pak™

Sealed Power For Environmental Connections



Marine | Wind Power | Lighting | Transportation | Pumps | Ground Support
Machine Tool | Industrial Automation | Motor | Solar Power | Harsh Environments



APP
Anderson Power Products

Rugged and Sealed (IP68) Plugs and Receptacles

For Use with APP® Powerpole® Signal, Power & Ground Contacts & Housings

APP's SPEC Pak™ Connector Series uses rugged and environmentally sealed (IP68) shells to protect existing APP® Powerpole® contacts and housings. Customer configured SPEC Pak™ Connectors may be used anywhere a rugged and waterproof high-power, signal and ground interconnect solution is required such as in; mass transportation, off-road vehicles, factory automation, oil and petrochemical exploration, agricultural equipment, and many more.

The core APP® Powerpole® technology within the SPEC Pak™ is proven reliable and cost effective. The broad selection of touch safe, color coded Powerpole® housings with power, signal and ground contacts accept a broad range of wire gauges, #24 to #10 AWG (0.25 to 4.0 mm²), giving users thousands of flexible design solutions in a single interconnect.

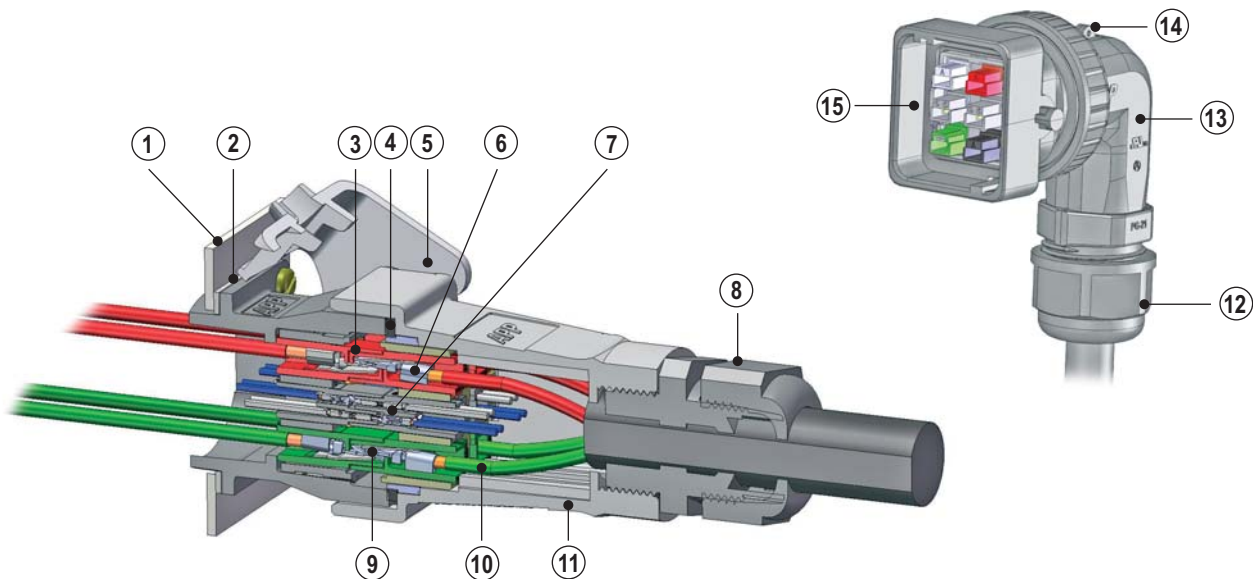

1 - Industry Standard Panel Cut Out

(Same as 26482 & 5015 shell size 24)

2 - IP68 Panel Mount Sealing Gasket

3 - Touch Safe Housings (UL1977, Section 10.2)

4 - IP68 Interfacial Sealing Gasket

5 - Latch (top or bottom of plug or receptacle)

6 - Power Contacts (up to 45 amps)

7 - Signal Contacts (4 contacts per Powerpole® housing)

8 - Uses Industry Standard Sealing Components

(PG gland compatible - size 21)

9 - First Mate / Last Break Ground Contacts

10 - Color Coded Housings to Match Wire Color

11 - UV & Chemical Resistant Ruggedized Shells

Additional Features Available on the Right Angle Include:

12 - Uses Industry Standard PG Gland

(PG gland compatible - size 21 or 29)

13 - Right Angle Backshell Lockable in 8 Directions for Cable Routing

14 - Integrated Strain Relief

15 - Ruggedized Right Angle Plug Shell

Specifications

SPEC Pak™ Shell / Components

Electrical

UL Voltage Rating (AC/DC)	600
Dielectric Withstanding Voltage (AC)	3000
Operating Temperature (°C)	-40° to 105°
(°F)	-40° to 221°
Flammability Rating of Shells	UL 94V-0

Mechanical

Shells / Latch Mating Cycles	1500 Min
Connect / Disconnect (lbf)	18 Max
(N)	80 Max
IP Rating	IP68
Sealing Meets (IP68), Meets Sealing Requirements of	UL50

Material

Shells (Plug / Receptacle)	PBT
Latch & Retention Pins	Nylon
Holder	Polycarbonate

PPMX (4850 Series) Powerpole® Signal Contact

Ratings for SPEC Pak™ Use

Electrical

UL Current Rating (Amperes)	1
Voltage Rating (AC/DC)	300
Contact Barrel Wire Size (AWG)	#20 to #24
(mm ²)	0.5 to 0.25
Contact Retention Force (lbf)	14.0
(N)	62.0
Insertion Force (lbf)	4.5 Max
(N)	20.0 Max
Operating Temperature (°C)	-20° to 105°
(°F)	-4° to 221°

Mechanical

Life	
• Mating Cycles (no load)	1500

Material

Housing Material	PBT
Contact Material	Copper Alloy
Contact Plating	Gold, 50 Micro-inches

NOTE: PPMX Contacts, up to 4 per housing

Powerpole® Power (1327FP Series) & Ground Contact (1827 Series)

Ratings for SPEC Pak™ Use

Electrical

UL Current Rating (Amperes)	15 to 45
CSA (30°C Rise) (Amperes)	10 to 29
Voltage Rating (AC/DC)	600
Contact Barrel Wire Size (AWG) - Power	20 to 10
- Ground	14 to 10
(mm ²) - Power	0.5 to 4.0
- Ground	1.5 to 4.0
Average Contact Resistance (micro-ohms)	600
Contact Retention Force (lbf)	25
(N)	111
Operating Temperature (°C)	-20° to 105°
(°F)	-4° to 221°
Flammability Rating	UL94 V-0

Mechanical

Life	
• No Load (mating cycles)	
- Tin	1,500
- Silver	10,000
• Under Load (Hot Plug 250 mating cycles @ 120V) *	30A
(Hot Plug 250 mating cycles @ 72V) *	45A
Mechanical Shock (50 g)	Mil Standard 202 213 Cond. A
Vibration (10 g)	Mil Standard 202 204 Cond. A

Material

Housing Material	Polycarbonate
Touch Safe (Power / Signal Housing)	UL1977 Sec. 10.2
Contact Material	Copper
Contact Plating	Tin or Silver

* Hot Plug testing completed with individual Powerpole® housings

NOTE: Agency approvals - TUV Pending / Patents & Patents Pending

 File No. E26226



Part Number Configurator

PART NUMBER PLAN

SPEC Pak™ Series (1 fixed character) Shell Color (1 character) Shell Style (1 character) Dash Shell Size (mm) (3 characters) Insert Arrangement (3 characters)

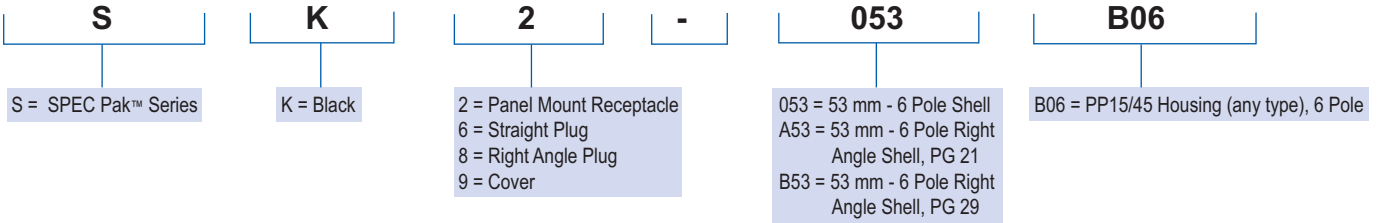

PLUG KIT

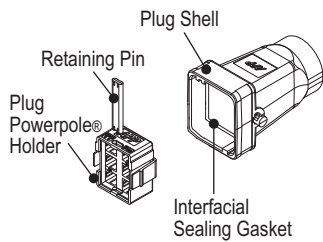

RIGHT ANGLE PLUG KIT

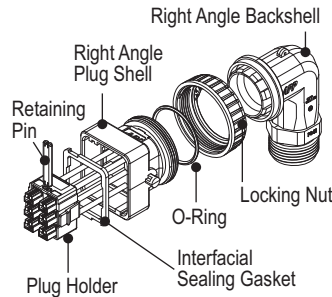

PANEL MOUNT RECEPTACLE KIT

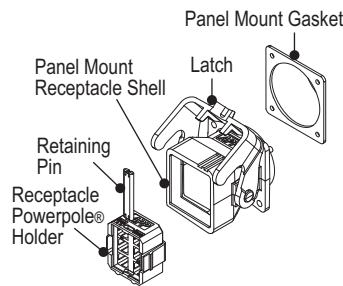

RECEPTACLE COVER KIT

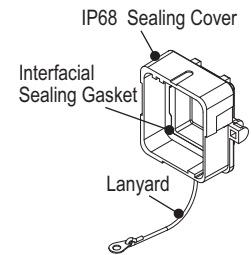

NOTE:
 - Mounting hardware (4 each - M3.5 or #6 screws) not included
 - Recommended torque for mounting hardware is 3½ to 5 in-lbf (0.4 to 0.56 Nm)

KIT ORDERING INFORMATION

SPEC Pak™ Kits

Part Number	Description
SK6-053B06	Plug kit - Plug shell (includes interfacial sealing gasket) - Powerpole® holder for plug - Retaining pin
SK8-A53B06	Right angle plug kit for PG 21 - Right angle backshell for PG 21 - Locking nut - O-ring - Plug shell - Retaining pin - Powerpole® holder for plug
SK8-B53B06	Right angle plug kit for PG 29 - Right angle backshell for PG 29 - Locking nut - O-ring - Plug shell - Retaining pin - Powerpole® holder for plug

SPEC Pak™ Kits

Part Number	Description
SK2-053B06	Receptacle kit - Panel mount gasket for receptacle - Receptacle shell with latch - Retention pin - Powerpole® holder for receptacle
SK9-053	Cover kit (receptacle only) - Protective sealing (IP68) cover for receptacle with lanyard

Component Replacement Parts

Part Number	Description
114765P1	Panel mount gasket for receptacle
2-8658P1	6 position latch
2-8654P1	Right angle locking nut
114915P2	Right angle O-ring

PART NUMBER PLAN

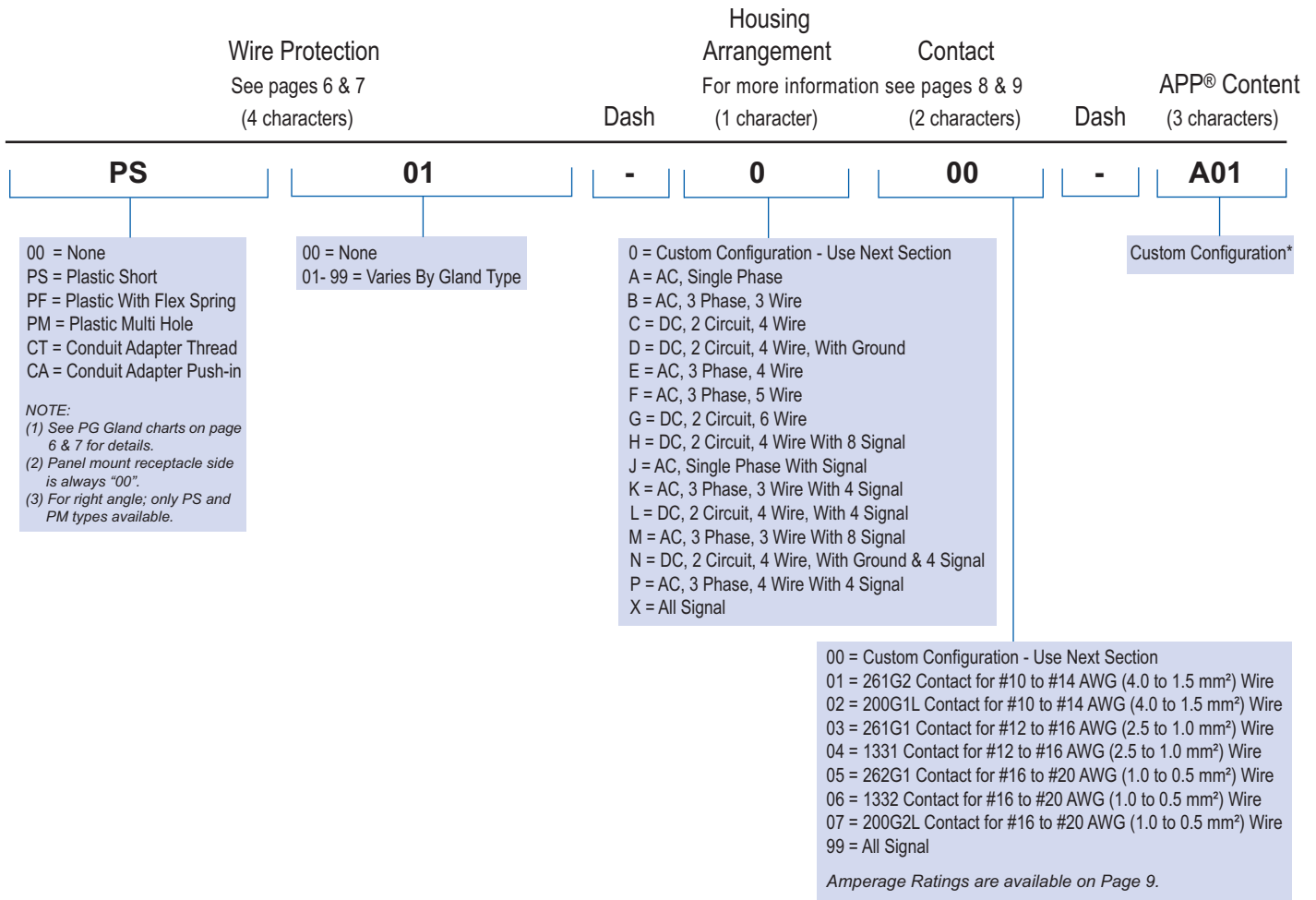

Part Numbering Notes:

- 1) To order SPEC Pak™ "Kits Only" (no internal Powerpole® housings or contacts), use part numbering on page 4 only. **Plug Kit Example: SK6-053B06** Powerpole® housings, contacts and wire protection may be ordered separately, see pages 6, 7 and 10 for information.
- 2) To order complete standard configured SPEC Pak™ connectors (including internal Powerpole® housings and contacts) use Part Number Plan across the top of pages 4 and 5. **Standard SPEC Pak™ Plug Configuration Example: SK6-053B06PS01-D02**
- 3) To order a custom configuration which is not listed on page 8 and 9, use APP® custom part number configurator on the APP® website, www.andersonpower.com, or contact factory.

* Custom configurations may not be UL Recognized.

Wire Protection - PG Glands

SPECIFICATIONS

Material (Push-in Conduit)

Shell	Nylon PA
Gasket	TPE
Color	Black

Mechanical

Operating Temp	-30°C to 100°C (-22°F to 212°F)
IP Rating	IP68
Thread Type	PG

Material (All Others)

Shell	Nylon PA 66 (UL94 V-2)*
Gasket	EPDM
Color	Black

Mechanical

Operating Temp	-40°C to 105°C (-40°F to 221°F)
IP Rating	IP68
UV Rating	Equivalent to UL746C F1
Thread Type	PG

Torque Requirements

Cable Gland Body to Plug Housing
- Hand tighten until snug, tighten additional 1/8 - 1/4 turn with wrench

Sealing Nut to Cable
- Hand tighten until snug, tighten additional 1/2 - 3/4 turn with wrench



* Contact factory for UL94 V-0 material

NOTE: Only UL listed cable glands are UL recognized components when used with SPEC Pak™ connector(s).

STRAIGHT PLASTIC SHORT THREAD TYPE - STD PACK 50 / UL LISTED

Straight Gland Kit						Right Angle Gland Kit		
APP® P/N	APP® P/N	Wire Protection Designation	Cable Range	Thread O. D.	Panel Mounting	Thread Length	Wrench Size	Wrench Size
Right Angle	Straight	4 Characters	Wire Outer Dia. mm (in)	C1 mm (in)	Hole mm (in)	C2 mm (in)	Lock Nut (mm)	Sealing Nut (mm)
RPS1P21-16X	PS1P21-16X	PS01	16.2 - 10.5 (0.64 - 0.41)	28.3 (1.11)	28.3 - 28.7 (1.11 - 1.13)	12 (0.47)	36	33
RPS1P21-18X	PS1P21-18X	PS02	18.5 - 13 (0.73 - 0.51)	28.3 (1.11)	28.3 - 28.7 (1.11 - 1.13)	12 (0.47)	36	33
RPS1P29-22X	N/A	PS11	22 - 16 (0.86 - 0.63)	37 (1.46)	37 - 37.4 (1.46 - 1.47)	12 (0.47)	46	42
RPS1P29-25X	N/A	PS12	25 - 18 (0.98 - 0.71)	37 (1.46)	37 - 37.4 (1.46 - 1.47)	12 (0.47)	46	42

STRAIGHT PLASTIC WITH FLEX SPRING - STD PACK 50 / UL LISTED

APP® P/N	Wire Protection Designation	Cable Range	Thread O. D.	Panel Mounting	Thread Length	Wrench Size	Wrench Size
Straight	(4 Characters)	Wire Outer Dia. mm (in)	C1 mm (in)	Hole mm (in)	C2 mm (in)	Lock Nut (mm)	Sealing Nut (mm)
PF1P21-16X	PF01	5.8 - 10.5 (0.62 - 0.41)	28.3 (1.11)	28.3 - 28.7 (1.11 - 1.13)	12 (0.47)	36	33

LOCK NUT FOR PG 21 CABLE GLANDS

	APP® P/N	Wrench Size	Std. Pkg.
Lock Nut	124G30	Lock Nut (mm)	Size
		36	50

STRAIGHT PLASTIC MULTI-HOLE TYPE - STD PACK 50 / NOT UL LISTED

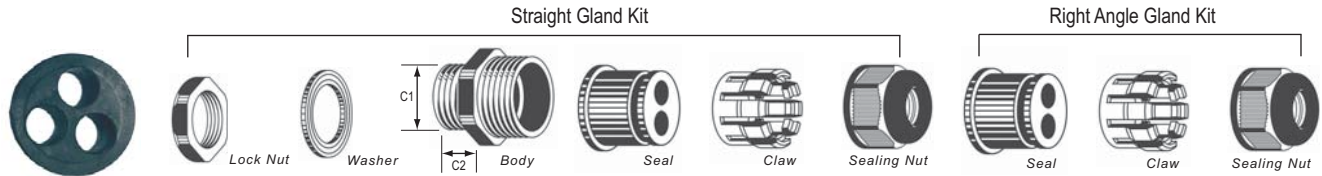

APP® P/N Right Angle	APP® P/N Straight	Wire Protection Designation (4 Characters)	Number of Holes	Cable Range Wire Outer Dia. mm(in)	Thread O.D. C1 mm (in)	Panel Mounting Hole mm (in)	Thread Length C2 mm (in)	Wrench Size Lock Nut (mm)	Wrench Size Sealing Nut (mm)
RPS2P21-5X	PS2P21-5X	PM21	2	5.2 - 3.6 (0.20 - 0.14)	28.3 (1.11)	28.3 - 28.7 (1.11 - 1.13)	12.5 (0.49)	36	33
RPS2P21-6X	PS2P21-6X	PM22	2	6.5 - 5.1 (0.26 - 0.20)	28.3 (1.11)	28.3 - 28.7 (1.11 - 1.13)	12.5 (0.49)	36	33
RPS2P21-8X	PS2P21-8X	PM23	2	8.7 - 6.4 (0.34 - 0.25)	28.3 (1.11)	28.3 - 28.7 (1.11 - 1.13)	12.5 (0.49)	36	33
RPS3P21-5X	PS3P21-5X	PM31	3	5.2 - 3.6 (0.20 - 0.14)	28.3 (1.11)	28.3 - 28.7 (1.11 - 1.13)	12.5 (0.49)	36	33
RPS3P21-6X	PS3P21-6X	PM32	3	6.2 - 4.8 (0.24 - 0.19)	28.3 (1.11)	28.3 - 28.7 (1.11 - 1.13)	12.5 (0.49)	36	33
RPS3P21-8X	PS3P21-8X	PM33	3	8.0 - 6.2 (0.31 - 0.24)	28.3 (1.11)	28.3 - 28.7 (1.11 - 1.13)	12.5 (0.49)	36	33
RPS4P21-3X	PS4P21-3X	PM41	4	3.1 - 2.0 (0.12 - 0.08)	28.3 (1.11)	28.3 - 28.7 (1.11 - 1.13)	12.5 (0.49)	36	33
RPS4P21-4X	PS4P21-4X	PM42	4	4.1 - 3.0 (0.16 - 0.12)	28.3 (1.11)	28.3 - 28.7 (1.11 - 1.13)	12.5 (0.49)	36	33
RPS4P21-5X	PS4P21-5X	PM43	4	5.2 - 3.8 (0.20 - 0.15)	28.3 (1.11)	28.3 - 28.7 (1.11 - 1.13)	12.5 (0.49)	36	33
RPS4P21-7X	PS4P21-7X	PM44	4	7.3 - 5.6 (0.29 - 0.22)	28.3 (1.11)	28.3 - 28.7 (1.11 - 1.13)	12.5 (0.49)	36	33
RPS5P21-3X	PS5P21-3X	PM51	5	3.6 - 2.6 (0.14 - 0.10)	28.3 (1.11)	28.3 - 28.7 (1.11 - 1.13)	12.5 (0.49)	36	33
RPS5P21-4X	PS5P21-4X	PM52	5	4.6 - 3.6 (0.18 - 0.14)	28.3 (1.11)	28.3 - 28.7 (1.11 - 1.13)	12.5 (0.49)	36	33
RPS5P21-6X	PS5P21-6X	PM53	5	6.0 - 4.6 (0.24 - 0.18)	28.3 (1.11)	28.3 - 28.7 (1.11 - 1.13)	12.5 (0.49)	36	33
RPS6P21-3X	PS6P21-3X	PM61	6	3.6 - 2.6 (0.14 - 0.10)	28.3 (1.11)	28.3 - 28.7 (1.11 - 1.13)	12.5 (0.49)	36	33
RPS6P21-5X	PS6P21-5X	PM62	6	5.2 - 3.6 (0.20 - 0.14)	28.3 (1.11)	28.3 - 28.7 (1.11 - 1.13)	12.5 (0.49)	36	33

STRAIGHT CONDUIT ADAPTER THREAD TYPE - STD PACK 50 / NOT UL LISTED

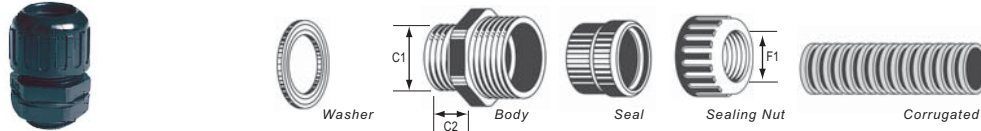

APP® P/N	Wire Protection Designation (4 Characters)	Max. Joint F1 mm (in)	Thread O.D. C1 mm (in)	Panel Mounting Hole mm (in)	Thread Length C2 mm (in)	Wrench Size Lock Nut (mm)	APP® Conduit P/N	Conduit O. D.
CT1P21-21X	CT02	22.0 (0.87)	28.3 (1.11)	28.3 - 28.7 (1.11 - 1.13)	12 (0.47)	36	NGN - 17B	21.2 (0.83)
CT1P21-26X	CT03	26.5 (1.04)	28.3 (1.11)	28.3 - 28.7 (1.11 - 1.13)	12 (0.47)	36	NGN - 22B	26.2 (1.03)
CT1P21-28X	CT04	28.5 (1.12)	28.3 (1.11)	28.3 - 28.7 (1.11 - 1.13)	12 (0.47)	36	NGN - 23B	28.5 (1.12)

STRAIGHT CONDUIT PUSH-IN TYPE - STD PACK 50 / NOT UL LISTED

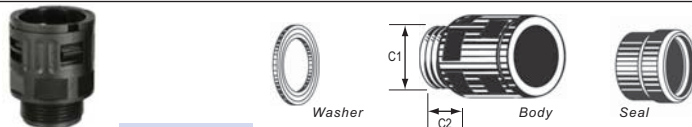

APP® P/N	Wire Protection Designation (4 Characters)	Thread O.D. C1 mm (in)	Panel Mounting Hole mm (in)	Thread Length C2 mm (in)	Wrench Size Lock Nut (mm)	APP® Conduit P/N	Conduit O. D.
CAP21-28X	CA04	28.3 (1.11)	28.3 - 28.7 (1.11 - 1.13)	12 (0.5)	36	NGN - 23B	28.5 (1.12)

CORRUGATED NYLON PLASTIC TUBING

APP® P/N	Conduit I. D. mm (in)	Conduit O. D. mm (in)	Conduit Size	Trade Size (mm)	Std. Pkg. Meters (Feet)
NGN - 17B	16.7 (0.66)	21.2 (0.83)	1/2"	OD21.2	50 (164)
NGN - 22B	21.2 (0.83)	26.2 (1.03)	-	-	50 (164)
NGN - 23B	21.7 (0.85)	28.5 (1.12)	3/4"	OD28.5	50 (164)

TUBING CUTTER



APP® P/N	Description	Range (mm)
TM0002	Corrugated Plastic Tubing Cutter	Up to OD 34.5

Standard Housing Arrangements & Contacts

HOUSING ARRANGEMENTS FOR POWER, SIGNAL & GROUND CONNECTORS

ARRANGEMENTS REPRESENT FRONT VIEW OF RECEPTACLE

Custom configurations may be created using APP's part number configurator at www.andersonpower.com

E = Empty 1327 Series = Power 1827 Series = Ground 4850 Series = Signal

0	Custom Configuration	
----------	----------------------	--

AC Single Phase		
A	1327G6FP	E
	E	1827G1
	1327G7FP	E

AC 3 Phase, 3 Wire		
B	1327G6FP	E
	1327G7FP	1827G1
	1327FP	E

DC 2 Circuit, 4 Wire		
C	1327G6FP	1327G6FP
	E	E
	1327FP	1327FP

DC 2 Circuit, 4 Wire With Ground		
D	1327G6FP	1327G6FP
	E	1827G1
	1327FP	1327FP

AC 3 Phase, 4 Wire		
E	1327G6FP	1327G8FP
	1327G7FP	1827G1
	1327FP	E

AC 3 Phase, 5 Wire		
F	1327G6FP	1327G8FP
	1327G7FP	1827G1
	1327FP	1327G16FP

DC 2 Circuit, 6 Wire		
G	1327FP	1327G6FP
	1327FP	1327G6FP
	1327FP	1327G6FP

DC 2 Circuit, 4 Wire With 8 Signal		
H	1327G6FP	1327G6FP
	4827G6	4827G6
	1327FP	1327FP

AC Single Phase With 4 Signal		
J	1327G6FP	E
	E	1827G1
	1327G7FP	4827G6

AC 3 Phase, 3 Wire With 4 Signal		
K	1327G6FP	E
	1327G7FP	1827G1
	1327FP	4827G6

DC 2 Circuit, 4 Wire With 4 Signal		
L	1327G6FP	1327G6FP
	E	4827G6
	1327FP	1327FP

AC 3 Phase, 3 Wire With 8 Signal		
M	1327FP	1327G7FP
	4827G6	4827G6
	1327G6FP	1827G1

DC 2 Circuit, 4 Wire With Ground & 4 Signal		
N	1327G6FP	1327G6FP
	4827G6	1827G1
	1327FP	1327FP

AC 3 Phase, 4 Wire With 4 Signal		
P	1327G6FP	1327G8FP
	1327G7FP	1827G1
	1327FP	4827G6

All Signal		
X	4827G6	4827G6
	4827G6	4827G6
	4827G6	4827G6

CONTINUOUS CURRENT RATINGS - POWER CONTACT CODE SELECTION

Contact Code	Power Contacts	Housing Configuration	Wire Size / Current Rating					
			#10	#12	#14	#16	#18	#20
00	Contacts Purchased Separately							
01	261G2	A - C	29/40	20/33	15/23	—	—	—
		D - G	24/36	20/25	15/21	—	—	—
		H - P	29/40	20/33	15/22	—	—	—
02	200G1L	A - C	27/37	20/32	15/22	—	—	—
		D - G	22/33	18/25	15/20	—	—	—
		H - P	27/37	20/32	15/22	—	—	—
03	261G1	A - C	—	20/33	15/23	12/18	—	—
		D - G	—	20/25	15/21	12/18	—	—
		H - P	—	20/33	15/22	12/18	—	—
04	1331	A - C	—	17/25	15/25	13/20	—	—
		D - G	—	15/25	15/22	13/18	—	—
		H - P	—	17/25	15/20	13/20	—	—
05	262G1	A - C	—	—	—	12/18	10/15	7/10
		D - G	—	—	—	12/18	8/13	6/9
		H - P	—	—	—	12/18	10/15	7/10
06	1332	A - C	—	—	—	13/20	9/14	6/9
		D - G	—	—	—	13/18	7/12	5/8
		H - P	—	—	—	13/20	9/14	6/9

NOTES:

- Current ratings:
 - First number represents current rating per pole for 30°C temperature rise (29 / 40)
 - Second number is the maximum recommended current per pole based on a 25°C ambient (29 / 40)
- Configuration H - P based on signal contacts crimped to #20 AWG wire and carrying 1 amp
- ☐ Denotes wire size not appropriate for power contact
- Shaded boxes are cULus File No. E26226 pending.
- 1827G1 housing with 1830G1 or 1830G2 ground contact depending on primary contacts (see chart above). All signal housings (4850) come with two 4802G3 and two 4802G3 contacts.

HOLDER LOCATIONS (VIEWS)

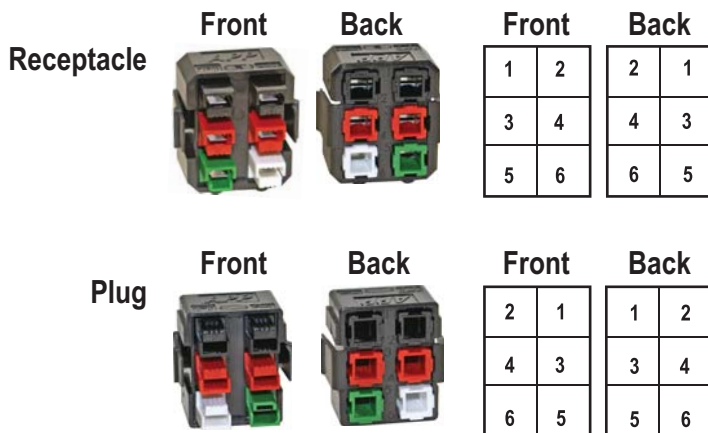

TEMPERATURE CHART

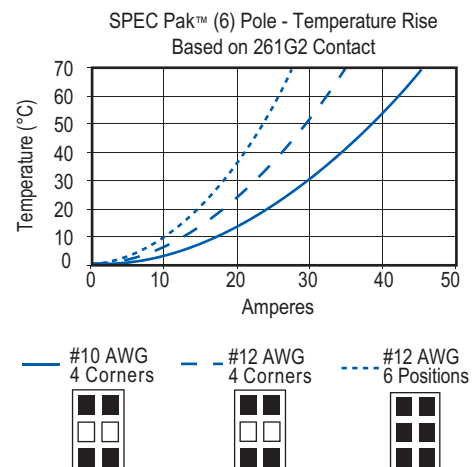

Individual Components

POWERPOLE® HOUSINGS & CONTACTS

Fingerproof PP15/45 Housing Only

Package Quantity:
Standard, 100 pieces - Bulk, 1,000 pieces

Standard Part Number	Bulk Part Number	Description
1327FP	1327FP-BK	Red Housing
1327G5FP	1327G5FP-BK	Green Housing
1327G6FP	1327G6FP-BK	Black Housing
1327G7FP	1327G7FP-BK	White Housing
1327G8FP	1327G8FP-BK	Blue Housing
1327G16FP	1327G16FP-BK	Yellow Housing

Standard PP 15/45 Housing Only

Package Quantity:
Standard, 100 pieces - Bulk, 1,000 pieces

Standard Part Number	Bulk Part Number	Description
1327	1327-BK	Red Housing
1327G5	1327G5-BK	Green Housing
1327G6	1327G6-BK	Black Housing
1327G7	1327G7-BK	White Housing
1327G8	1327G8-BK	Blue Housing
1327G16	1327G16-BK	Yellow Housing
1327G17	1327G17-BK	Orange Housing
1327G18	1327G18-BK	Gray Housing
1327G21	1327G21-BK	Brown Housing
1327G22	1327G22-BK	Pink Housing
1327G23	1327G23-BK	Purple Housing

Premate Ground PP15/45 Housing Only

Package Quantity:
Standard, 100 pieces - Bulk, 1,000 pieces

Standard Part Number	Bulk Part Number	Description
1827G1	1827G1-BK	Green Housing

Premate Ground Contacts

Loose Piece
Package Quantity 100

Part Number	Description
#10 to #14 AWG (4 to 1.5 mm ²)	
1830G1-LPBK	Singulated-LD-Tin Plate
1830G2-LPBK	Singulated-LD-Silver Plate

Reel
Package Quantity 5,000

Part Number	Description
#10 to #14 AWG (4 to 1.5 mm ²)	
1830G1	Reel-LD-Tin Plate
1830G2	Reel-LD-Silver Plate

15/45 Powerpole® Contacts

Loose Piece
Package Quantity:
Standard, 100 pieces - Bulk, 1,000 pieces

Standard Part Number	Bulk Part Number	Description
#16 to #20 AWG (1.0 to 0.5 mm ²)		
1332	1332-BK	Individual-LD-Silver Plate
262G1-LPBK	-	Singulated Reel-LD-Tin Plate
262G2-LPBK	-	Singulated Reel-LD-Silver Plate
#12 to #16 AWG (2.5 to 1.0 mm ²)		
1331	1331-BK	Individual-LD-Silver Plate
261G1-LPBK	-	Singulated Reel-LD-Tin Plate
#10 to #14 AWG (4 to 1.5 mm ²)		
261G2-LPBK	-	Singulated Reel-LD-Tin Plate
261G3-LPBK	-	Singulated Reel-LD-Silver Plate
200G1L-LPBK	-	Superflex, Sing. Reel-LD-Tin Plate

Reel - 15/45 Powerpole® Contacts
Package Quantity 5,000

Part Number	Description
#16 to #20 AWG (1.0 to 0.5 mm ²)	
262G1	Reel-LD-Tin Plate
262G2	Reel-LD-Silver Plate
#12 to #16 AWG (2.5 to 1.0 mm ²)	
261G1	Reel-LD-Tin Plate
#10 to #14 AWG (4 to 1.5 mm ²)	
261G2	Reel-LD-Tin Plate
261G3	Reel-LD-Silver Plate
#10 to #14 AWG (6 to 1.5mm ²)	
200G1L	SuperFlex, Reel-LD-Tin Plate

NOTE:
LD - Low Detent
For additional housing colors please contact customer service.

CONTACT STYLES

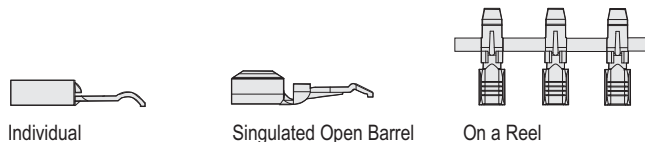

PPMX (4850 SERIES) HOUSING & CONTACTS

PPMX Housing

Package Quantity

Standard, 25 pieces - Bulk, 1,000 pieces

Standard Part Number	Bulk Part Number	Description
4827G6	4827G6-BK	Black two piece housing

PPMX Contacts

Package Quantity

Standard, 50 pieces - Bulk, 2,000 pieces

Loose Piece

#20 to #24 AWG (0.50 to 0.25 mm²)

Standard Part Number	Bulk Part Number	Description
4802G3	4802G3-BK	Socket, Gold, 50 Micro-inches
4803G3	4803G3-BK	Pin, Gold, 50 Micro-inches

PPMX Housing & Contact Kits

Package Quantity

Standard, 100 pieces

1 Black two piece housing, 2 Male Contacts,
2 Female Contacts

Standard Part Number	Bulk Part Number	Description
4850G6	-	50 Micro-inches Gold Plated Contacts - Pin & Socket

PP15/45 POWERPOLE® HOUSING STYLES

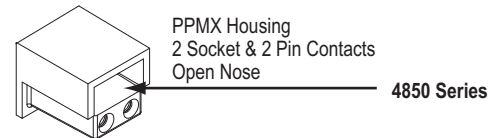
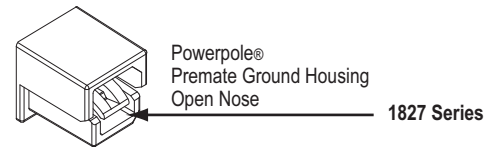

APPLICATION TOOLING - POWERPOLE® 15 / 45 CONTACTS

Loose Piece Tin Part Number	Loose Piece Silver Part Number	Hand Tool or Pneumatic Tool		Reeled Tin Part Number	Reeled Silver Part Number	ATS Applicator
N/A	1332	1309G2 or 1309G8	1367G1	N/A	N/A	N/A
N/A	1331			N/A	N/A	
262G1-LPBK	262G2-LPBK			1309G3 or 1309G8	N/A	261G1
200G2L-LPBK	200G4L-LPBK	200G2L	200G4L			TBD
261G1-LPBK	261G4-LPBK	261G1	261G4			1385520
261G2-LPBK	261G3-LPBK	261G2	261G3			1385458
200G1L-LPBK	200G3L-LPBK	200G1L	200G3L			1385460
1830G1-LPBK	1830G2-LPBK	1830G1	1830G2			1385460

* All Hand and Pneumatic Tools for use with Loose Piece contacts only. All reeled contacts can be ordered singulated, (Loose Piece) with the suffix "- LPBK"

** 1309G8 is a hand tool kit- includes dies and locators to make up 1309G2, 1309G3, & 1309G6

APPLICATION TOOLING - PPMX CONTACTS

Contact Part Number	Mil Std. Hand Tool		Pneumatic Tool for Locator / Turret	
	APP® Hand Tool or (APP Part #)	Positioner	+	+
4802G3	PM1000G1	M22520/1-01 (TM0001)	No Mil Std. (TL0005)	TP0001
4803G3				

Dimensions

PLUG 6 POSITION FOR PP15/45 HOUSINGS

Top View

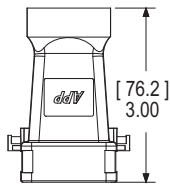

Front View

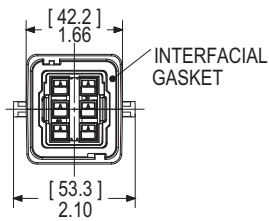

Side View

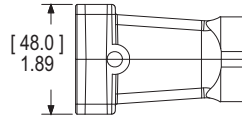

Mated Side View

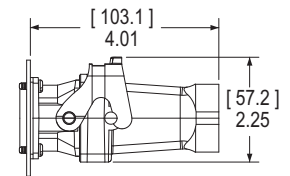

RIGHT ANGLE PLUG 6 POSITION FOR PP15/45 - GLAND SIZE PG 21

Top View

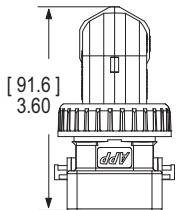

Front View

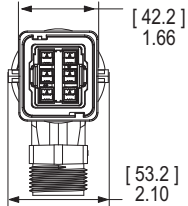

Side View

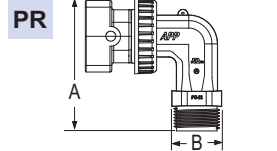

PG Gland	- A -	- B -		
	mm	in.	mm	in.
PG 21	104.7	4.12	36.4	1.43
PG 29	105.5	4.15	47.4	1.86

Mated Side View

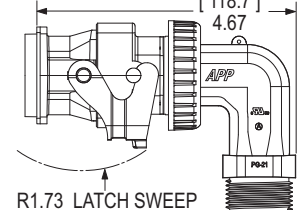

For PG 29 dimensions, please see APP website

RECEPTACLE 6 POSITION FOR PP15/45 HOUSINGS

Panel Cut Out

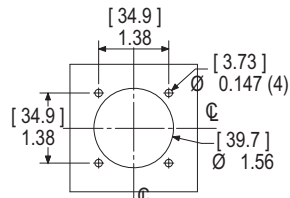

PANEL CUT OUT \varnothing
(SAME AS 26482 & 5015 SHELL SIZE 24)

Front View

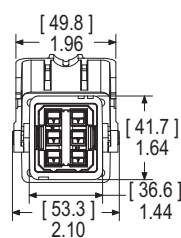

Side View

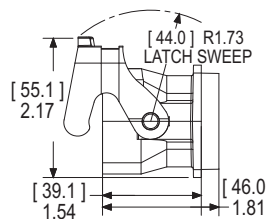

Back View

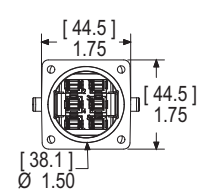

NOTE: Mounting hardware #6 screw / torque receptacle to panel 3/2 to 5 in-lbf (0.4 to 0.56 Nm)

PG GLANDS

PS

Plastic Short

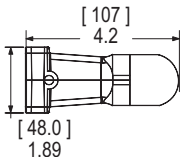

CT

Thread Conduit Adapter

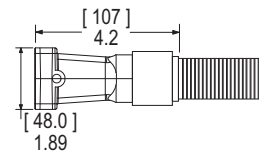

PF

Plastic Flex PG

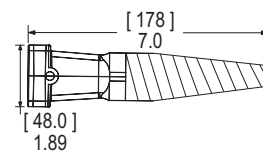

CA

Push-in Conduit Adapter

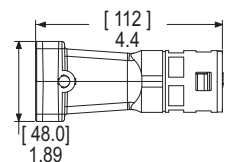

RECEPTACLE COVER KIT

Front View

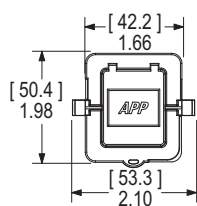

Side View

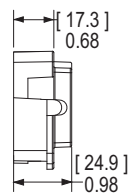

Mated Side View

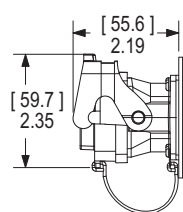

All Data Subject To Change Without Notice

Patents with Patents Pending

14787

DS-SPAK REV05

HEADQUARTERS: Anderson Power Products®, 13 Pratts Junction Road, Sterling, MA 01564-2305 USA T:978-422-3600 F:978-422-3700

EUROPE: Anderson Power Products® Ltd., Unit 3, Europa Court, Europa Boulevard, Westbrook, Warrington, Cheshire, WA5 7TN United Kingdom T: +44 (0) 1925 428390 F: +44 (0) 1925 520203

ASIA / PACIFIC: IDEAL Anderson Asia Pacific Ltd., Unit 922-928 Topsail Plaza, 11 On Sum Street, Shatin N.T., Hong Kong T: +(852) 2636 0836 F: +(852) 2635 9036

CHINA: IDEAL Anderson Technologies (Shenzhen) Ltd., Block A8 Tantou Western Industrial Park, Songgang Baoan District, Shenzhen, PR. China 518105 T: +(86) 755 2768 2118 F: +(86) 755 2768 2218

TAIWAN: IDEAL Anderson Asia Pacific Ltd., Taiwan Branch, 4F-2, No.116, Dadun 20th St., Situn District, Taichung City 407, Taiwan (R.O.C.) T: +(886) 4 2310 6451 F: +(886) 4 2310 6460

www.andersonpower.com

X-ON Electronics

Largest Supplier of Electrical and Electronic Components

Click to view similar products for [Heavy Duty Power Connectors](#) category:

Click to view products by [Anderson Power Products](#) manufacturer:

Other Similar products are found below :

[647757-1](#) [6643411-1](#) [6646058-2](#) [6646137-1](#) [6646138-1](#) [6646479-1](#) [6646608-1](#) [6646786-1](#) [6646940-1](#) [6651091-1](#) [6651525-1](#) [6651529-1](#)
[6651788-1](#) [696475-1](#) [73000005059](#) [73000005642](#) [765-15-0080A](#) [765-16-0080B](#) [829992-1](#) [902-77-02113](#) [129-1J](#) [AN0024023](#) [E6374G1](#)
[e6389g2](#) [157-43GW8](#) [MS3117-14AC](#) [1643543-1](#) [1650540-1](#) [1651811-2](#) [1766260-1](#) [1766282-1](#) [1766966-1](#) [1791340000](#) [NLDFT-3-BL-L-](#)
[S120-M40A](#) [NLDFT-N-W-L-C240-M40B](#) [NLS-2-R-C240-M40B](#) [NLS-N-W-C240-M40B](#) [NPS-3-BL-T6](#) [1986615-1](#) [2-1589900-8](#) [2199314-1](#)
[KA8102](#) [9300480317](#) [SBS50BRN#6](#) [29131](#) [29652](#) [1646905-1](#) [1648320-1](#) [1648582-1](#) [1650195-2](#)