

# SB<sup>®</sup> 50 Connectors - up to 120 amps

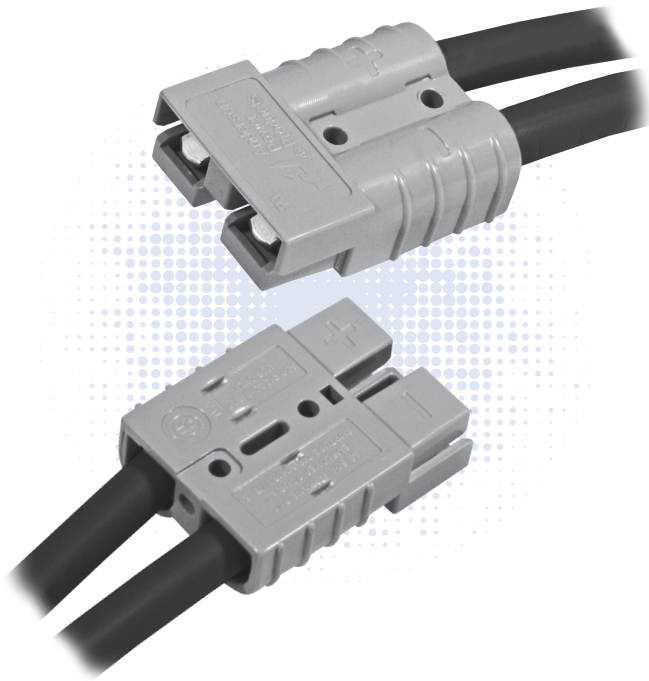

Based off the design pioneered by Anderson in 1953, APP's two pole SB<sup>®</sup> connectors set the standard for DC power distribution and battery connections. SB<sup>®</sup>50 connectors feature a one piece plastic housing using stainless steel springs to hold low resistance contacts in place. Wires sizes from #16 (1.5 mm<sup>2</sup>) to #6 (13.3 mm<sup>2</sup>) are held in the smallest of the SB<sup>®</sup> series housings.

- **Low Resistance Silver or Tin Plated Copper Contacts**  
*Allows UL rated currents up to 120 amps*
- **UL Rated for Hot Plugging up to 50 Amps**  
*Great for battery or other applications where the ability to interrupt circuits is required*
- **Wire, PCB, and Busbar Contacts**  
*Allows one connection system to meet multiple needs*

## | SB50<sup>®</sup> ORDERING INFORMATION |

### SB<sup>®</sup>50 Standard Housings

The smallest SB<sup>®</sup> housings work with wire contacts up to 6 AWG [10 mm<sup>2</sup>] as well as PCB, and busbar contacts. Genderless design mates with itself. Mechanical keys are color coded.

Description	Voltage Color Code	Part Numbers
Minimum Quantity ....	500	100 ...
Yellow	12V	992G5-BK 992G5
Orange	18V	992G7-BK 992G7
Red	24V	992G1-BK 992G1
Gray	36V	992-BK 992
Blue	48V	992G4-BK 992G4
Green	72V	992G6-BK 992G6
Black	80V	992G2-BK 992G2

NOTE: SB<sup>®</sup>50 Black and Gray housings have the same keying features and can be intermated.

### SB<sup>®</sup>50 Chemical Resistant Housings

Same features as the Standard SB<sup>®</sup>50 but molded in a chemical resistant PBT/ PC blend. Suitable for use to -40°C.

Description	Voltage Color Code	Part Numbers
Minimum Quantity ....	500	100 ...
Red	24V	P992G1-BK P992G1
Gray	36V	P992-BK P992
Black	80V	P992G2-BK P992G2

NOTE: SB<sup>®</sup>50 Black and Gray housings have the same keying features and can be intermated.

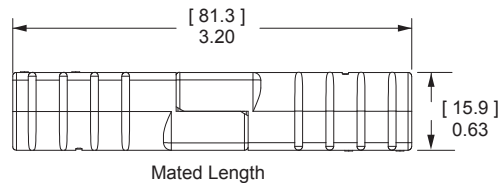
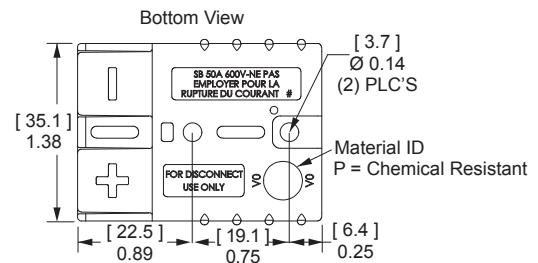

## SB®50 Silver Plated Wire Contacts

Use two silver plated contacts per housing for the best electrical performance and durability up to 10,000 mating cycles. See redushing bushings in accessory section for smaller wires.

AWG	mm <sup>2</sup>	Mating Force	Loose Piece		Dimensions	
			--- Part Numbers ---		- A -	
					inches	mm
Minimum Quantity .....			1,000	100		
6	13.3	Low	1307-BK	1307	0.22	5.59
6	13.3	High	5900-BK	5900	0.22	5.59
8	8.4	High	5952-Bk	5952	0.19	4.83
12 to 10	3.3 to 5.3	Low	5953-BK	5953	0.14	3.56
12 to 10	3.3 to 5.3	High	5915-BK	5915	0.14	3.56

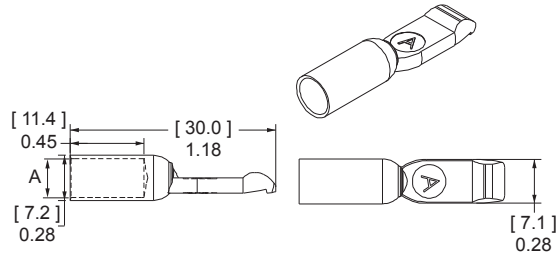

## SB®50 Silver Plated Busbar Contacts

Use 2 busbar contacts per housing to provide a quick disconnect input or output busbar connection. Busbar contacts are for mating with wire contacts only. Part number 75BBS includes lock nuts. Locknuts must be ordered separately for B01956P4.

Type	Thread	Mating Force	Loose Piece Part Numbers		
Minimum Quantity .....			1,000	20	10 ...
Busbar	#10-24	High	B01915P1	-	75BBS
Lock Nut	#10-24	-	H1216P8	110G54	-

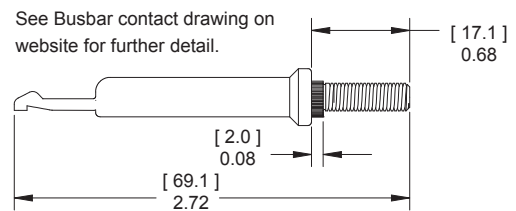

## 55A Right Angle Standard Powerclaw PCB Contacts

Standard Powerclaw contacts are for use inside a SB®50 housing and provide a color coded right angle connection to the PCB.

Description	- Loose Piece Part Numbers -	
Minimum Quantity ....	500	100 .....
Tin Plated	PC5930T-BK	PC5930T
Silver Plated	PC5930S-BK	PC5930S

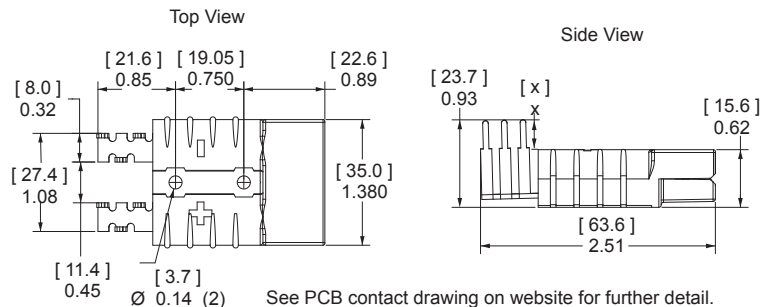

## 55A Right Angle Mini Powerclaw PCB Contacts

Right angle Mini Powerclaw contacts can be used on the PCB edge without a SB®50 housing on the PCB side. A self polarizing design only allow SB®50 wire housings to mate to PCB contacts one way.

Description	- Loose Piece Part Numbers -	
Minimum Quantity ....	1,000	100 .....
Tin Plated	PC5934T-BK	PC5934T
Silver Plated	PC5934S-BK	PC5934S

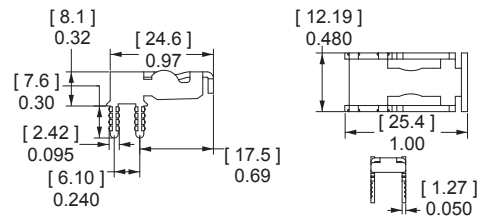

## 55A Vertical Mini Powerclaw PCB Contacts

Vertical Mini Powerclaw contacts save space by not requiring a SB®50 housing on the PCB side. The guide housing is required for to provide a polarized connection. (See SB®50 accessories).

Description	- Loose Piece Part Numbers -	
Minimum Quantity ....	1,500	100 .....
Tin Plated	PC5933T-BK	PC5933T
Silver Plated	PC5933S-BK	PC5933S

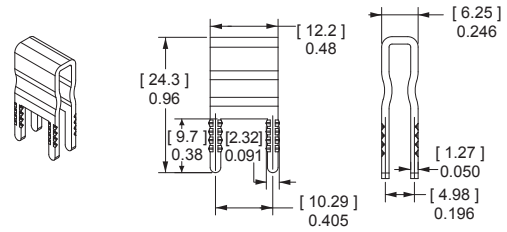

## | SB®50 CONNECTOR SPECIFICATIONS |

Electrical		
<b>Current Rating Amperes<sup>1</sup></b>	<b>UL 1977</b>	<b>CSA</b>
Wire to Wire UL 1977 (6 AWG)	120	50
Wire to PCB UL 1977 (6 AWG)	50	
<b>Voltage Rating AC/DC</b>		
UL 1977	600	
<b>PCB Connector Recommended Voltage per IEC 60950-1 Table 2L Pollution Degree<sup>2</sup></b>		
Mini Vert. Contact	522	
Mini Horiz. Contact	504	
Standard Contact	950	
<b>Dielectric Withstanding Voltage</b>		
Volts AC	2,200	
<b>Avg. Mated Contact Resistance Milliohms<sup>1</sup></b>		
1 1/4" of #6 AWG wire	0.200	
PCB Contact to Contact	0.500	
<b>UL Hot Plug Current Rating Amperes - 250 cycles at 120V DC</b>		
Wire- wire	50A	
PCB- wire	40A	
(Vertical Mini Powerclaw)		

Materials	
<b>Housing</b>	
Standard Plastic Resin	Polycarbonate
Chem. Resistant Resin	Polycarbonate / PBT blend
Contact Retention Spring	Stainless Steel
<b>Housing Flammability Rating</b>	
UL94	V-0
<b>Contact</b>	
Base	Copper Alloy
Wire Plating	Silver
PCB Plating	Sn or Ag over Ni
<b>Contact Termination Methods</b>	
Crimp <sup>3</sup>	Wire Contacts
Hand Solder	Wire and PCB Contacts
Solder Dip*	PCB Contacts
Wave Solder*	PCB Contacts
Wrench / Socket	Busbar Contacts

Mechanical		
<b>Wire Size Range</b>	<b>AWG</b>	<b>mm<sup>2</sup></b>
Wire Contacts with Bushings	16 to 6	1.3 to 13.3
<b>Max. Wire Insulation Diameter</b>	<b>in.</b>	<b>mm</b>
	0.440	11.200
<b>Operating Temperature<sup>2</sup></b>	<b>°F</b>	<b>°C</b>
Standard	-4° to 221°	-20° to 105°
Chemical Resistant*	-40 to 221°	-40° to 105°
*Chemical resistant material not available for PCB guide housings		
<b>Mating Cycles No Load by Plating</b>	<b>Silver (Ag)</b>	<b>Tin (Sn)</b>
Wire and PCB Contacts	10,000	1,500
<b>Avg. Mating / Unmating Force</b>	<b>Lbf.</b>	<b>N</b>
Wire to Wire Low Force Contacts	10	44
Wire to Wire High Force Contacts	15	67
Standard Powerclaw to Wire	15	66
Mini Powerclaw to Wire	8	36
<b>PCB Specifications</b>		
Mounting Style	Plated Through Hole	
Max PCB Thickness- in. [mm]	Standard: 0.15 [0.381]	
	Mini: 0.25 [0.635]	
Recommended Traces	#8 AWG Cross Section	
<b>Min. Contact / Spring Retention Force</b>	<b>Lbf.</b>	<b>N</b>
Wire Housing	50	222
<b>Min. Creepage / [Clearance] Distance</b>	<b>in.</b>	<b>mm</b>
Standard Powerclaw	0.374	9.5
Mini Vert. Powerclaw	0.213	5.4
Mini Horiz. Powerclaw	0.205	5.2

Protection	
<b>Touch Safety with Wire Contacts</b>	
IEC 60529	IP10

<sup>1</sup> Based on: 105°C rated or better cable of the largest size, Properly calibrated APP® recommended tooling, and a 25°C ambient temperature. UL rating not to exceed the maximum operating temperature. CSA rating below a 30°C temperature rise.

<sup>2</sup> Limited by the thermal properties of the connector plastic housing.

<sup>3</sup> Use APP® recommended tooling only. Alternate tools may adversely affect the performance of our connectors along with UL and CSA recognition.



# | SB®50 CONNECTOR TEMPERATURE CHARTS |

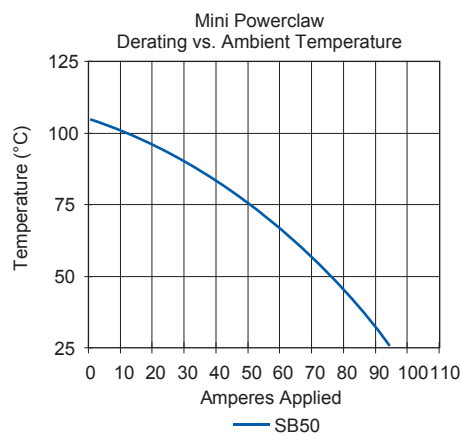
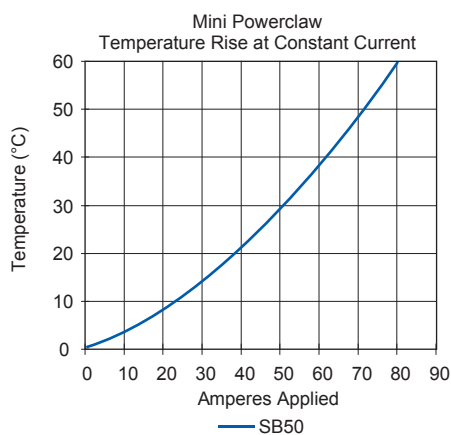
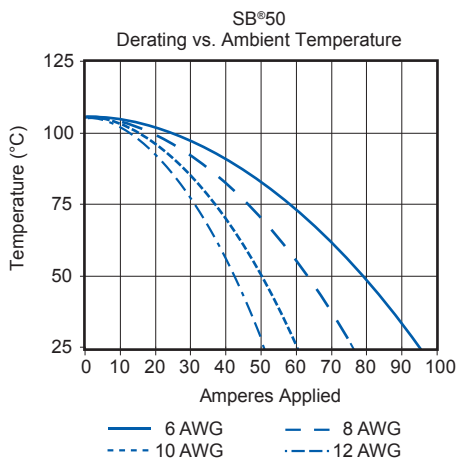
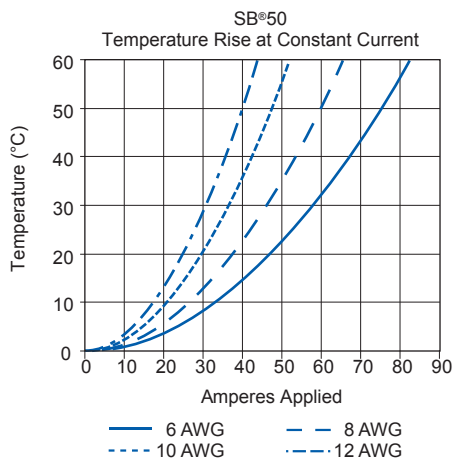

NOTE: Temperature rise charts are based on a 25°C ambient temperature. Powerclaw charts are based on #8 AWG equivalent copper foil on board side, mated to #6 AWG conductor on wire side.

SECTION 3  
SB® 50

## | SB® Accessories |

### “T” Handle

The “T” handle makes mating and unmating the connector easier. The non-conductive red plastic material is strong and safe. (2) Self tapping screws are used to secure the handle to the connector housing.

Description	----- Part Numbers -----	
Minimum Quantity .....	1,000	50 .....
Red “T” Handle + Hardware Bag	-	SB50-HDL-RED
Hardware Bag (2 Screws)	-	104G17
Red “T” Handle Only	113899P1	-
#8 x 5/8” Screw (Order 2 Per Handle)	H1120P53	-

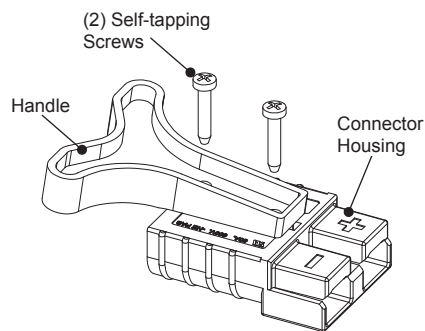

### Dust Cover

Prevents dust and dirt from entering the mating interface of the connector when unmated. NOTE: Not a Hermetic Seal.

Description	---- Part Numbers ----	
Minimum Quantity .....	500	50 ...
Dust Cover with Lanyard Strap, Red	113890P1	134G1

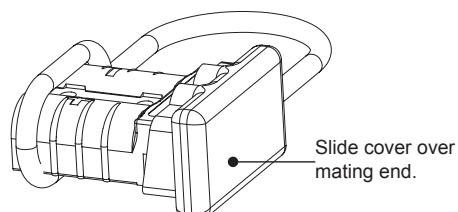

### Guide Housings for Vertical Mini Powerclaw Contacts

Prevents polarity being reversed when a SB®50 is mated to vertical mini Powerclaw contacts.

Description	----- Part Numbers -----	
Minimum Quantity ....	1,000	50 .....
Black Guide Housing	PC-HSG-SB-BK	PC-HSG-SB

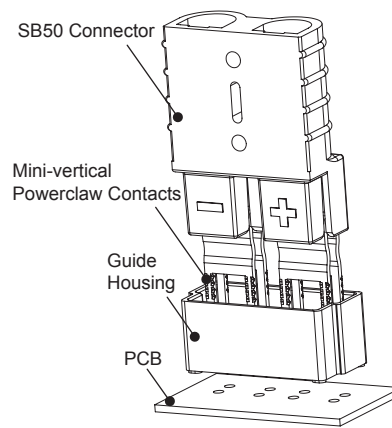

### Cable Clamps

Durable metal cable clamps securely hold cables to prevent accidental strain or pulls from dislodging wire or contacts from the housing. Cable clamps are recommended for solder terminated wires.

Description	Cable Size		----- Part Numbers -----	
	AWG or (Inches O.D.)	mm <sup>2</sup> or (mm O.D.)		
Minimum Quantity .....			500	50 ...
Self Attaching for Discrete Conductor	8 to 6	10	990-BK	990
Self Attaching for Discrete Conductor	12 to 10	4 to 6	990G2-BK	990G2
Bolt on for Discrete Conductor	12 to 6	4 to 10	990G1-BK	990G1
Bolt on for Bundled Conductor	(0.320 to 0.450)	(4.27 to 11.43)	5905-BK	5905

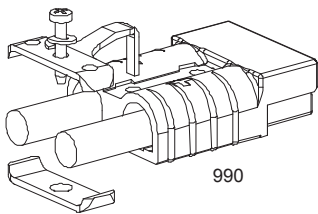

Self attaching discrete conductor.

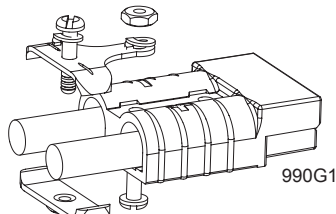

Bolt on discrete conductor.

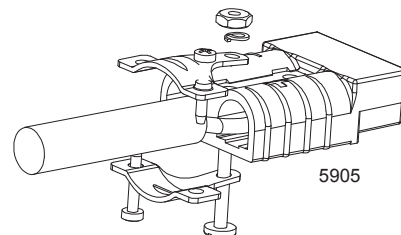

Bolt on bundled conductors.

The given wire O.D. information is an estimate. Cable clamps should be evaluated for performance with the actual wire to be used.

### Reducing Bushings

Use with contact part number 5900-BK or 1307-BK to allow a smaller wire to be used with the connector. Electrical capability is derated with smaller wire.

Contact Barrel Size	Wire Size	----- Part Numbers -----			Dimensions			
					- ID -	- Length -		
					inches	mm	inches	mm
Minimum Quantity .....		3,000	1,000	100				
#6 AWG [13.3 mm <sup>2</sup> ]	#8 AWG [8.4 mm <sup>2</sup> ]	-	5912-BK	5912	0.18	4.57	0.45	11.43
#6 AWG [13.3 mm <sup>2</sup> ]	#12- 10 AWG [3.3- 5.3 mm <sup>2</sup> ]	5910-BK	-	5910	0.14	3.56	0.47	11.94
#6 AWG [13.3 mm <sup>2</sup> ]	#16- 14 AWG [1.3- 2.1 mm <sup>2</sup> ]	5913-BK	-	5913	0.09	2.29	0.47	11.94

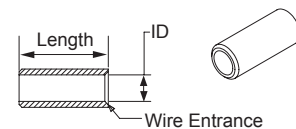

# SB<sup>®</sup>

## - Tooling Information

Wire Size		Loose Piece Part Numbers	Loose Piece Contact Crimp Tools				Reeled Part Numbers	Reeled Contact Crimp Tools			
AWG	mm <sup>2</sup>		Hand Tool or	Pneumatic Bench Tool	+ Die	+ Locator		Number of Crimps	Tin Plating	ATS Applicator	ATS Press
<b>SB50</b>											
#6	13.3	1307 5900	1309G4	1387G1	1388G6	1389G6	Single	265G5	1385523-1	2-565435-2	692655-1
#8	8.4	5952			1388G7			265G6	1385522-1	1725900-2 or [3-54500-1]	1424266-1 or [354578-1]
#10 / 12	5.3 / 3.3	5953 5915									
<b>SB120</b>											
#1	42.4	1323G1	1368	1387G1	1388G3	1389G4	Single	N/A	N/A		
#2	33.6	1319			1388G4						
#4	21.2	1319G4									
#6	13.3	1319G6									
<b>SB175</b>											
1/0	53.5	1382	1368	1387G2	1303G13	1304G32	Double	N/A	N/A		
#1	42.4	1347		1387G1	1388G3	1389G3	Single				
#2	33.6	1383		1387G2	1303G13	1304G32	Double				
#4	21.1	1384		1387G1	1388G3	1389G3	Single				
				1387G2	1303G13	1304G32	Double				
#6	13.3	1348		1387G1	1388G4	1389G3	Single				
<b>SB350</b>											
300mcm	152	910	1368	N/A			Single	N/A	N/A		
4/0	107.2	908		1387G2	1303G3	1304G31	Double				
3/0	85	916			1303G12						
2/0	67.4	907									
1/0	53.5	917									

NOTE: See website for the most current information.

## X-ON Electronics

Largest Supplier of Electrical and Electronic Components

*Click to view similar products for [Heavy Duty Power Connectors](#) category:*

*Click to view products by [Anderson Power Products](#) manufacturer:*

Other Similar products are found below :

[647757-1](#) [6643411-1](#) [6646058-2](#) [6646137-1](#) [6646138-1](#) [6646479-1](#) [6646608-1](#) [6646786-1](#) [6646940-1](#) [6651091-1](#) [6651525-1](#) [6651529-1](#)  
[6651788-1](#) [696475-1](#) [73000005059](#) [73000005642](#) [765-15-0080A](#) [765-16-0080B](#) [829992-1](#) [902-77-02113](#) [129-1J](#) [AN0024023](#) [E6374G1](#)  
[e6389g2](#) [157-43GW8](#) [MS3117-14AC](#) [1643543-1](#) [1650540-1](#) [1651811-2](#) [1766260-1](#) [1766282-1](#) [1766966-1](#) [1791340000](#) [NLDFT-3-BL-L-](#)  
[S120-M40A](#) [NLDFT-N-W-L-C240-M40B](#) [NLS-2-R-C240-M40B](#) [NLS-N-W-C240-M40B](#) [NPS-3-BL-T6](#) [1986615-1](#) [2-1589900-8](#) [2199314-1](#)  
[KA8102](#) [9300480317](#) [SBS50BRN#6](#) [29131](#) [29652](#) [1646905-1](#) [1648320-1](#) [1648582-1](#) [1650195-2](#)