

The innovative SB<sup>®</sup> connectors provide cost-effective reliability, design flexibility and safety for your products' manufacture, installation and maintenance.

APP's 2 pole connector is available with a 200 amp rating, 600 Volts continuous AC or DC operation. With the addition of the extended range contact, this robust connector will now accept wire sizes from #1 to #6 AWG (42.4 to 13.3 mm<sup>2</sup>), giving user more current capability. Mechanical keys ensure connectors will only mate with connectors of the same color. Different color housings are selected to identify voltages, thus preventing mismatching of the power supply system.

## FEATURES

- **Molded Side Grooves**

*Allows for a secure panel mounting fit*

- **Mechanical Keyed Housings**

*Prevents accidental mating of components operating at different voltage levels*

- **Single-piece Housing and Unitized Construction**

*Provides industrial quality and durability*



## PRODUCT SPECIFICATIONS

Connector Model	SB <sup>®</sup> 120	Connector Model	SB <sup>®</sup> 120
Current Rating (Amperes)*	190*	Life	
Voltage Ratings (AC/DC)	600*	a. No Load (mating cycles)	10,000
Contact Barrel Wire Size (AWG)	#1 to #6	b. Under Load (Hot Plug 250 mating cycles @ 120V)	60A
(mm <sup>2</sup> )	42.4 to 13.3	Average Connection/Disconnect (lbf)	20
Maximum Wire Insulation Diameter (inches)	0.575	(N)	89
(mm)	14.6	Operating Temperature (°C)**	-20° to 105°
Average Contact Resistance* (micro-ohms)	136	(°F)	-4° to 221°
Dielectric Withstanding Voltage (AC)	2,200	Flammability Rating of Housing Material	UL94 V-0
Contact Retention Force (lbf)	100		



\* UL Rated for 75°C largest wire or cable size

\*\* Contact factory for higher temperature rated connector

SB<sup>®</sup>, UL and CSA Reference: This equipment is an Underwriters Laboratories Inc<sup>®</sup> recognized component. It is also listed by the Canadian Standards Association as certified.

## ORDERING INFORMATION

### 2 Pole Housing & 120 amp Contacts

Part Number	Housing Color	Wire	
		AWG	sq. mm
6800G1	Gray	#2	33.6
6801G1	Blue	#2	33.6
6802G1	Red	#2	33.6
6800G2	Gray	#4	21.1
6801G2	Blue	#4	21.1
6802G2	Red	#4	21.1
6800G3	Gray	#6	13.3
6801G3	Blue	#6	13.3
6802G3	Red	#6	13.3

### Housing Only

Part Number	Description
6810G1	Gray housing
6810G2	Blue housing
6810G3	Red housing

Note: For additional colors please contact customer service

### 120 amp Contacts

Part Number	Description	Wire	
		AWG	sq. mm
6811G1	Contact set (2)	#2	33.6
6811G2	Contact set (2)	#4	21.1
6811G3	Contact set (2)	#6	13.3
120BBS	Bus Bar	N/A	N/A
6811G7	Extended range	#1	42.4

### Bushings

Part Number	Description	Wire	
		AWG	sq. mm
5919	Use with 6811G1	#2 to #4	33.6/21.2
5920	Use with 6811G1	#2 to #6	33.6/13.3
5921	Use with 6811G1	#2 to #8	33.6/8.4

### Accessories

Part Number	Description
SB120-HDL-RED	SB handle with hardware-red
981G1	Cable clamp for 2 single conductor cables
110G57	Lock nut for use with Bus bar contact
134G4	Dust cover, black
1467G1	Panel mount bracket, set (2)
981G2	Twin conduit cable clamp

### Tooling

Part Number	Description
1368	Hand tool - #1 to #8
1387G1	Pneumatic tool - #1 to #8
1388G4	- die for #2 to #8
1389G4	- locator #2 to #8
1388G3	- die for #1
1389G3	- locator for #1

## DIMENSIONS

### Housing

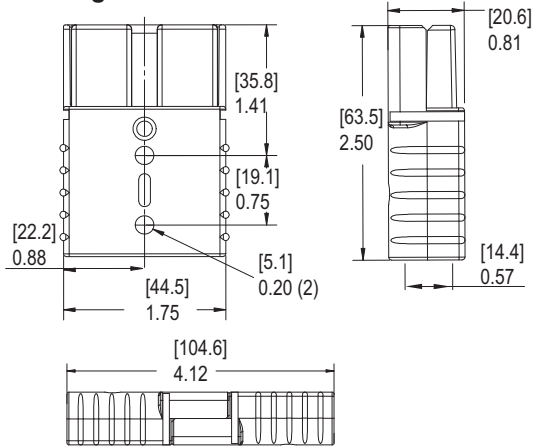

### Contacts

Part Number	-A-		-B-		-C-		-D-	
	mm	in.	mm	in.	mm	in.	mm	in.
6811G1	50.8	2.00	11.1	0.44	8.7	0.34	21.3	0.84
6811G2	50.8	2.00	11.1	0.44	7.5	0.30	21.3	0.84
6811G3	50.8	2.00	11.1	0.44	5.6	0.22	21.3	0.84
120BBS	77.0	3.03	11.2	0.44	9.5	0.38	N/A	#10-24Thd.
1323G1	50.8	2.00	11.9	0.47	9.9	0.39	21.3	0.84

Part Number	Contact Detent	-E-		-F-		-J-		-K-	
		mm	in.	mm	in.	mm	in.	mm	in.
6811G1	Low	10.4	0.41	N/A	N/A	N/A	N/A	N/A	N/A
6811G2	Low	10.4	0.41	N/A	N/A	N/A	N/A	N/A	N/A
6811G3	Low	10.4	0.41	N/A	N/A	N/A	N/A	N/A	N/A
120BBS	N/A	68.6	2.70	5.1	0.20	23.57	0.928	21.08 (min)	0.83(min)

Part Number	Contact Detent	-L-		-M-	
		mm	in.	mm	in.
120BBS	N/A	7.37	0.29	6.35	0.25

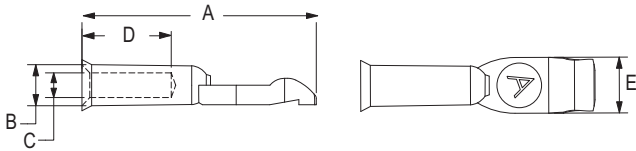

SB Contact

## TEMPERATURE RISE CHARTS

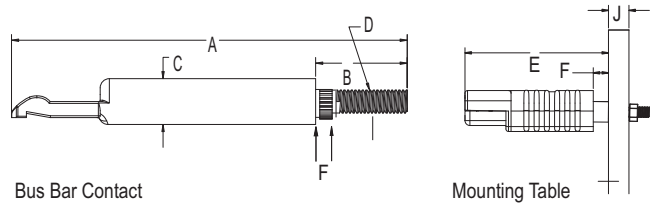
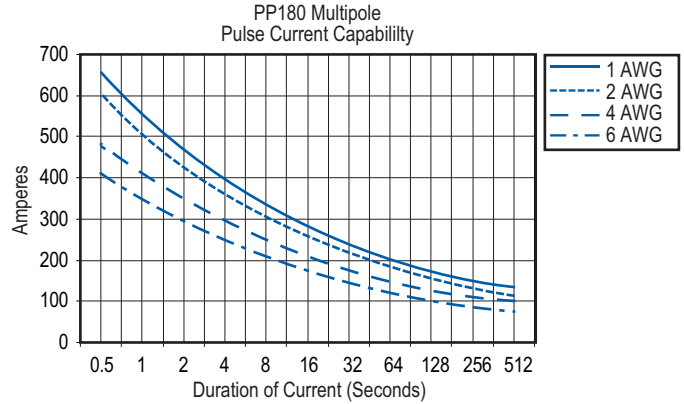
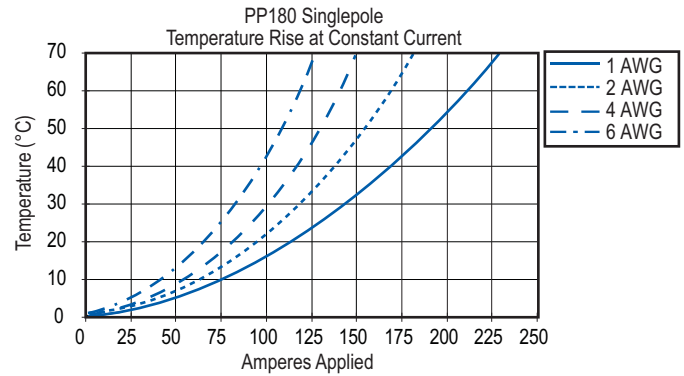

Bus Bar Contact

Mounting Table

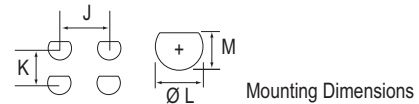

Mounting Dimensions

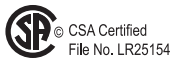

All Data Subject To Change Without Notice

14867 DS-SB120 REV09

## X-ON Electronics

Largest Supplier of Electrical and Electronic Components

*Click to view similar products for [Heavy Duty Power Connectors](#) category:*

*Click to view products by [Anderson Power Products](#) manufacturer:*

Other Similar products are found below :

[647757-1](#) [6643411-1](#) [6646058-2](#) [6646137-1](#) [6646138-1](#) [6646479-1](#) [6646608-1](#) [6646786-1](#) [6646940-1](#) [6651091-1](#) [6651525-1](#) [6651529-1](#)  
[6651788-1](#) [696475-1](#) [73000005059](#) [73000005642](#) [765-15-0080A](#) [765-16-0080B](#) [829992-1](#) [902-77-02113](#) [129-1J](#) [AN0024023](#) [E6374G1](#)  
[e6389g2](#) [157-43GW8](#) [MS3117-14AC](#) [1643543-1](#) [1650540-1](#) [1651811-2](#) [1766260-1](#) [1766282-1](#) [1766966-1](#) [1791340000](#) [NLDFT-3-BL-L-](#)  
[S120-M40A](#) [NLDFT-N-W-L-C240-M40B](#) [NLS-2-R-C240-M40B](#) [NLS-N-W-C240-M40B](#) [NPS-3-BL-T6](#) [1986615-1](#) [2-1589900-8](#) [2199314-1](#)  
[KA8102](#) [9300480317](#) [SBS50BRN#6](#) [29131](#) [29652](#) [1646905-1](#) [1648320-1](#) [1648582-1](#) [1650195-2](#)