



## ORDERING INFORMATION

### Tooling

Part Number	Description
1387G3	Hydraulic tool for power contacts
E160-36	Extraction tool

Note: For tooling die information, see tooling chart on website.

## DIMENSIONS

### Pin Contact

Part AWG	- Wire -		- ØA -		- ØB -		Number mm <sup>2</sup>
	mm	in.	mm	in.	mm	in.	
160-1016	16	#6	8.4	0.33	6.0	0.24	
160-1025	25	#4	11.0	0.43	8.0	0.31	
160-1035	35	#2	12.5	0.49	9.0	0.35	
160-1050	50	#1/0	14.5	0.57	11.0	0.43	

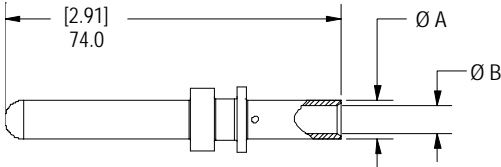

### Upper Auxiliary Contact

E160-32 upper auxiliary contact for 4 mm<sup>2</sup> (#12 AWG)

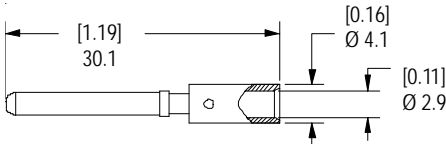

### Lower Auxiliary Contact

160-12 lower auxiliary contact for 6 mm<sup>2</sup> (#10 AWG)

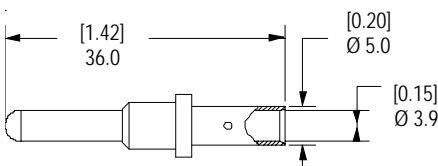

### Handle / Lever Assembly / Latch

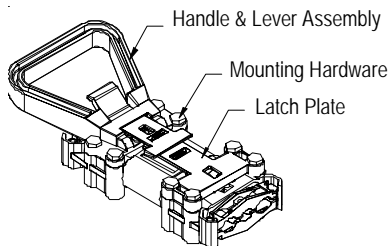

### Housing Front View

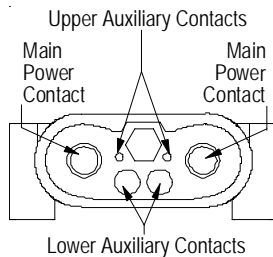

## TEMPERATURE CHARTS

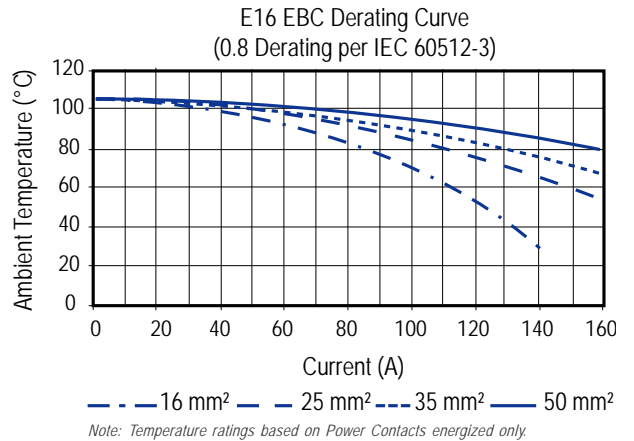
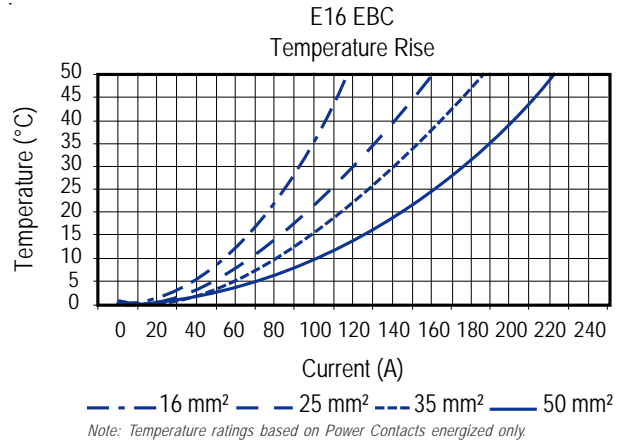

### Housing Side View

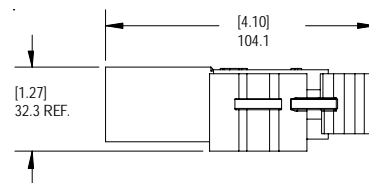

### Housing Top View

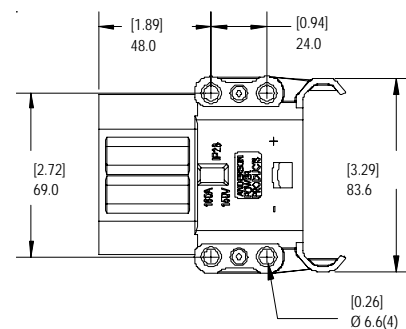

## X-ON Electronics

Largest Supplier of Electrical and Electronic Components

*Click to view similar products for* [Heavy Duty Power Connectors](#) *category:*

*Click to view products by* [Anderson Power Products](#) *manufacturer:*

Other Similar products are found below :

[1424439](#) [1424438](#) [09330062652](#) [2-8675P1](#) [580129-2](#) [605601-1](#) [6340G1](#) [6341G1](#) [6360G1](#) [6373G1](#) [6374g2](#) [6396G1](#) [647757-1](#) [66394-4](#)  
[6643411-1](#) [6646058-2](#) [6646137-1](#) [6646138-1](#) [6646348-1](#) [6646479-1](#) [6646608-1](#) [6646786-1](#) [6646940-1](#) [6651091-1](#) [6651525-1](#) [6651529-1](#)  
[6651778-1](#) [6651788-1](#) [696465-1](#) [696475-1](#) [73000005059](#) [73000005349](#) [73000005642](#) [73080255059](#) [73080965046](#) [765-15-0080A](#)  
[765-16-0080B](#) [789.700-44](#) [789.700-54](#) [80-1010](#) [80-9](#) [827381-1](#) [829992-1](#) [902-77-02113](#) [PL00U-301-10D10](#) [PM103MOOLOO](#)  
[PM16S1620S32-50](#) [PM212MOOLOO](#) [PM309FOOLOO](#) [PM324FOOLCH](#)