

Anderson Power Products' family of Euro Battery Connectors (EBC) exceeds all the requirements of DIN 43589-1 and EN 1175-1. The connector design incorporates an innovative, cost effective contact carrier for ease of assembly.

The connectors have a Degree of Protection of IP23 per IEC 60529. The acid resistance and temperature range of the PBT-PC housing exceeds the requirements of EN 1175-1. Contacts are pure copper with silver plate for maximum conductivity.

All materials meet RoHS requirements and are selected to ensure years of reliable service under adverse battery environments.

Features

- **Sturdy advanced polymer housings**

PBT-PC alloy housings provides superior resistance to acids and temperature extremes

- **DIN 43589-1 voltage keying**

Dry-cell, wet-cell & universal keying plugs coded for 24 / 36 / 48 / 72 / 80 & 96 volts DC

- **Mating compatibility with connectors of other manufacturers**

APP "E" series connectors offer dimensional compatibility for air tube and auxiliary contacts over and above the DIN 43589-1 compatibility of housings and main contacts



- **Silver plated pure copper contacts**
For lowest voltage drop and superior performance

SPECIFICATIONS

Electrical		Mechanical	
Current Rating (Amperes) *		Life	
UL	160	a. No Load (mating cycles)	>5000
EN1175-1:1998	140	b. Under Load (Hot Plug 5 mating cycles @96V)	200A
CSA	120	Average Mating / Unmating Force (lbf)	12
Voltage Rating		(N)	53
UL / CSA	600	Degree of Protection	IP23
EN1175-1:1998	150	Acid Resistance	1.38g / cm ³
Wire Range		Contact Retention - minimum (lbf)	100
- Power Contacts - AWG (mm ²)	#8 to #2 (10 / 35)	(N)	445
- Auxiliary Contacts - AWG (mm ²)	#18 to #14 (1.5 / 2.5)	Air Tube Rating	2 bar
Dielectric Withstanding Voltage (AC)	2,200	Materials	
Average Contact Resistance (micro-ohms)	65	Housing	PBT/PC blend, glass filled
Operating Temperature (°C)	-25° to 105°	Contacts	Copper alloy, silver plate
(°F)	-13° to 221°	Hardware	Steel, zinc chromate plate

* Current derating curves must be observed as current capacity will vary dependent on wire cross section and ambient temperature. Maximum current carrying capacity is measured at 40°C / 104°F using the maximum wire cross section permissible, crimped to contacts using APP recommended tooling.

ORDERING INFORMATION

Connector Part Number Selection

Series	Gender	Main Contact	Handle	Coding Key	Auxiliary Contacts & Air Tubes	Packaging
E80	4	25	1	0	2	9
4	Plug					9 Individual
00	None - Order Separately				0 None	8 Bulk
10	10 mm ² / #8 AWG				1 (2) Lower Auxiliary Contacts	
16	16 mm ² / #6 AWG				2 (2) Upper Auxiliary Contacts	
25	25 mm ² / #4 AWG				4 (2) Lower Auxiliary Contacts & (2) Upper Auxiliary Contacts	
35	35 mm ² / #2 AWG			0 Grey, Wet Cell		
0	No			2 Green, Dry Cel	5 Air Tube	
1	Black			3 Yellow, Universal	6 Air Tube & (2) Upper Auxiliary Contacts	
2	Red					

Accessories

Part Number	Description
E80-20	Twin air tube
E80-89	Handle kit

HEADQUARTERS: Anderson Power Products®, 13 Pratts Junction Road, Sterling, MA 01564-2305 USA T:978-422-3600 F:978-422-3700

EUROPE: Anderson Power Products® Ltd., Unit 3, Europa Court, Europa Boulevard, Westbrook, Warrington, Cheshire, WA5 7TN United Kingdom T: +44 (0) 1925 428390 F: +44 (0) 1925 428399

ASIA / PACIFIC: IDEAL Anderson Asia Pacific Ltd., Unit 922-928 Topsail Plaza, 11 On Sum Street, Shatin N.T., Hong Kong T: +(852) 2636 0836 F: +(852) 2635 9036

CHINA: IDEAL Anderson Technologies (Shenzhen) Ltd., Block A8 Tantou Western Industrial Park, Songgang Baoan District, Shenzhen, P.R. China 518105 T: +(86) 755 2768 2118 F: +(86) 755 2768 2218

TAIWAN: IDEAL Anderson Asia Pacific Ltd., Taiwan Branch, 4F-2, No.116, Dadun 20th St., Situn District, Taichung City 407, Taiwan (R.O.C.) T: +(886) 4 2310 6451 F: +(886) 4 2310 6460

www.andersonpower.com

ORDERING INFORMATION

Tooling

Part Number	Description
1387G3	Hydraulic tool for power contacts
E160-36	Extraction tool

Note: For tooling die information, see tooling chart on website.

DIMENSIONS

Pin Contact

Part Number	- Wire -		- Ø A -		- Ø B -	
	mm ²	AWG	mm	in.	mm	in.
80-1010	10	#8	6.1	0.24	4.6	0.18
80-1016	16	#6	8.4	0.33	6.1	0.24
80-1025	25	#4	10.9	0.43	7.9	0.31
80-1035	35	#2	12.4	0.49	8.9	0.35

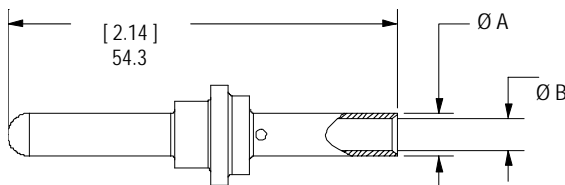

Upper Auxiliary Contact

E80-32 upper auxiliary contact for 1.5 mm² / 2.5 mm² (#18 / #14 AWG)

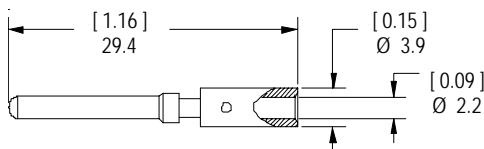

Lower Auxiliary Contact

E80-30 lower auxiliary contact for 1.5 mm² / 2.5 mm² (#18 / #14 AWG)

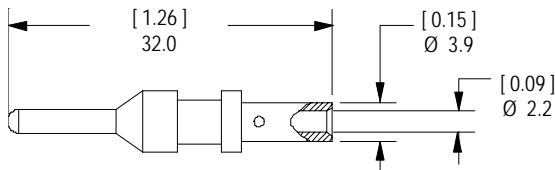

Housing Front View

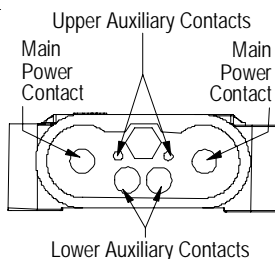

TEMPERATURE CHARTS

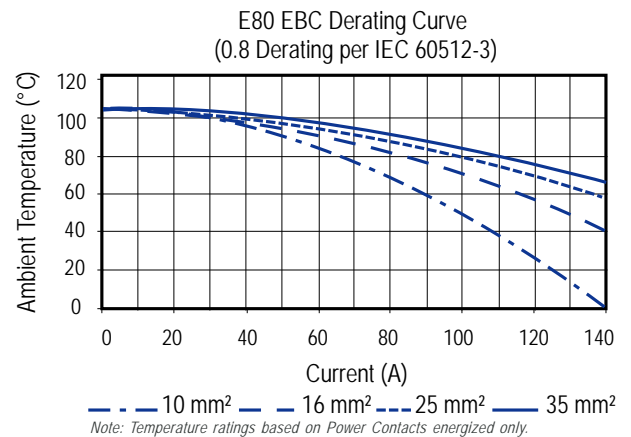
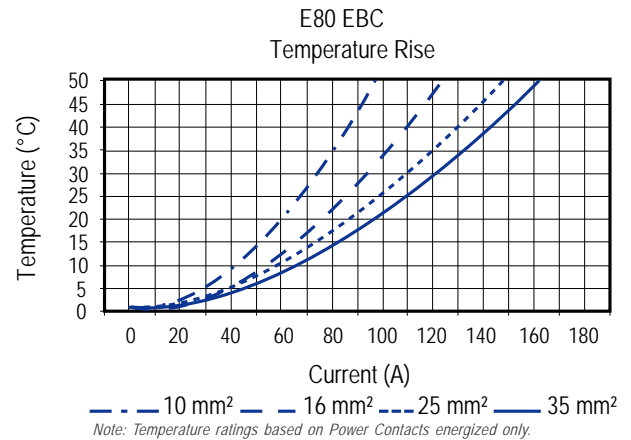

Housing Side View

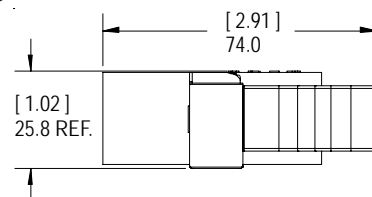

Housing Top View

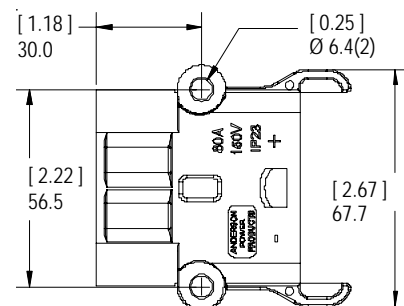

File No. E26226 All Data Subject To Change Without Notice

DS-E80EBCM REV07

HEADQUARTERS: Anderson Power Products®, 13 Pratts Junction Road, Sterling, MA 01564-2305 USA T:978-422-3600 F:978-422-3700

EUROPE: Anderson Power Products® Ltd., Unit 3, Europa Court, Europa Boulevard, Westbrook, Warrington, Cheshire, WA5 7TN United Kingdom T: +44 (0) 1925 428390 F: +44 (0) 1925 428399

ASIA / PACIFIC: IDEAL Anderson Asia Pacific Ltd., Unit 922-928 Topsail Plaza, 11 On Sum Street, Shatin N.T., Hong Kong T: +(852) 2636 0836 F: +(852) 2635 9036

CHINA: IDEAL Anderson Technologies (Shenzhen) Ltd., Block A8 Tantou Western Industrial Park, Songgang Baoan District, Shenzhen, P.R. China 518105 T: +(86) 755 2768 2118 F: +(86) 755 2768 2218

TAIWAN: IDEAL Anderson Asia Pacific Ltd., Taiwan Branch, 4F-2, No.116, Dadun 20th St., Situn District, Taichung City 407, Taiwan (R.O.C.) T: +(886) 4 2310 6451 F: +(886) 4 2310 6460

www.andersonpower.com

X-ON Electronics

Largest Supplier of Electrical and Electronic Components

Click to view similar products for [Heavy Duty Power Connectors](#) category:

Click to view products by [Anderson Power Products](#) manufacturer:

Other Similar products are found below :

[647757-1](#) [6643411-1](#) [6646058-2](#) [6646137-1](#) [6646138-1](#) [6646479-1](#) [6646608-1](#) [6646786-1](#) [6646940-1](#) [6651091-1](#) [6651525-1](#) [6651529-1](#)
[6651788-1](#) [696475-1](#) [73000005059](#) [73000005642](#) [765-15-0080A](#) [765-16-0080B](#) [829992-1](#) [902-77-02113](#) [129-1J](#) [AN0024023](#) [E6374G1](#)
[e6389g2](#) [157-43GW8](#) [MS3117-14AC](#) [1643543-1](#) [1650540-1](#) [1651811-2](#) [1766260-1](#) [1766282-1](#) [1766966-1](#) [1791340000](#) [NLDFT-3-BL-L-](#)
[S120-M40A](#) [NLDFT-N-W-L-C240-M40B](#) [NLS-2-R-C240-M40B](#) [NLS-N-W-C240-M40B](#) [NPS-3-BL-T6](#) [1986615-1](#) [2-1589900-8](#) [2199314-1](#)
[KA8102](#) [9300480317](#) [SBS50BRN#6](#) [29131](#) [29652](#) [1646905-1](#) [1648320-1](#) [1648582-1](#) [1650195-2](#)