

4 POSITION SPEC Pak[®]

Sealed Power For Environmental Connections



Marine | Wind Power | Lighting | Transportation | Pumps | Ground Support
Machine Tool | Industrial Automation | Motor | Solar Power | Harsh Environments



APP
Anderson Power Products

Rugged and Sealed (IP68) Plugs and Receptacles

For Use with APP® Powerpole® Signal, Power & Ground Contacts & Housings

APP's SPEC Pak® Connector Series uses rugged and environmentally sealed (IP68) shells to protect existing APP® Powerpole® contacts and housings. Customer configured SPEC Pak® Connectors may be used anywhere a rugged and waterproof high-power interconnect with signal and ground capabilities is required such as in; mass transportation, off-road vehicles, factory automation, oil and petrochemical exploration, agricultural equipment, and many more.

The core APP® Powerpole® technology within the SPEC Pak® is proven reliable and cost effective. The broad selection of touch safe, color-coded Powerpole® housings with power, signal and ground contacts accept a broad range of wire gauges, #24 to #10 AWG (0.25 to 4.0 mm²), giving users thousands of flexible design solutions in a single interconnect.

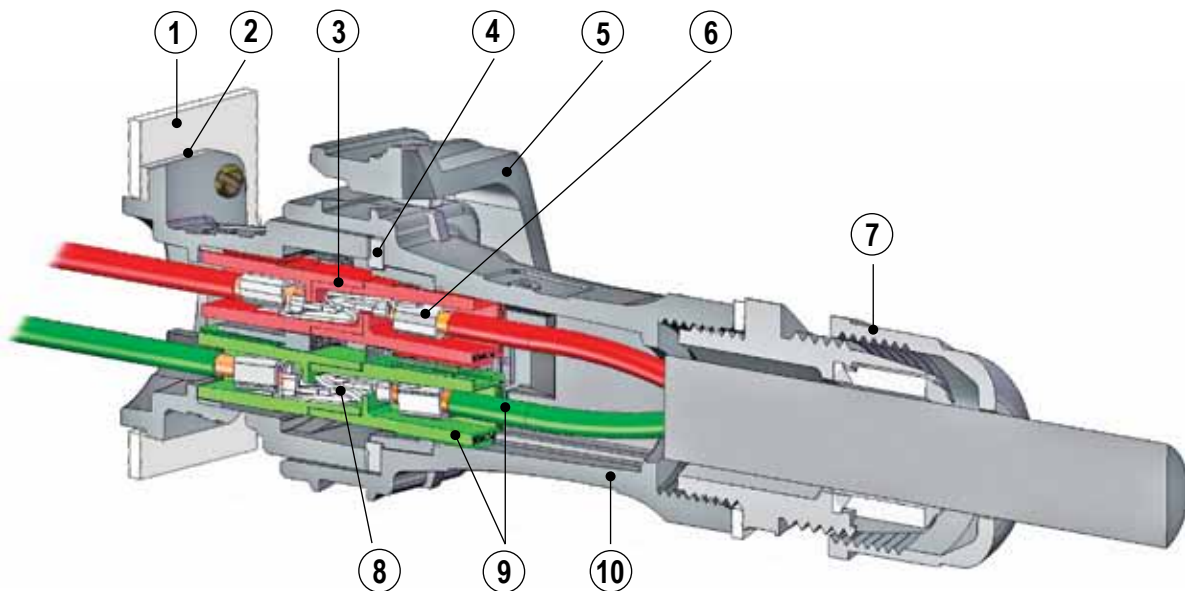

1 - Industry Standard Panel Cut Out
(Same as 26482 & 5015 shell size 20)

2 - IP68 Panel Mount Sealing Gasket

3 - Touch Safe Housings (UL1977, Section 10.2)

4 - IP68 Interfacial Sealing Gasket

5 - Latch (top or bottom of plug or receptacle)

6 - Power Contacts (up to 4) and / or **Signal Contacts** (up to 16)

7 - Uses Industry Standard Sealing Components
(PG gland compatible - size 16)

8 - First Mate / Last Break Ground Contacts

9 - Color Coded Housings Match Wire Colors

10 - UV & Chemical Resistant Ruggedized Shells

Specifications

SPEC Pak® Shell / Components

Electrical

UL Voltage Rating (AC/DC)	600
Dielectric Withstanding Voltage (AC)	3000
Operating Temperature (°C)	-40° to 105°
(°F)	-40° to 221°
Flammability Rating of SPEC Shells	UL 94V-0

Mechanical

Shells / Latch Mating Cycles	1500 Min
Connect / Disconnect (lbf)	12 Max
(N)	53 Max
IP Rating	IP68
UL50 Sec 36 Sealing Requirement	Pass

Material

Shells (Plug / Receptacle)	PBT
Latch	Nylon
Holder	Polycarbonate

PPMX (4850 Series) Powerpole® Signal Contact

Ratings for SPEC Pak® Use

Electrical

UL Current Rating (Amperes)	7
Voltage Rating (AC/DC)	300
Contact Barrel Wire Size (AWG)	#20 to #24
(mm ²)	0.5 to 0.25
Contact Retention Force (lbf)	12.0
(N)	53.0
Insertion Force (lbf)	4.5 Max
(N)	20.0 Max
Operating Temperature (°C)	-20° to 105°
(°F)	-4° to 221°

Mechanical

Mating Cycles	1500
---------------	------

Material

Housing Material	PBT
Contact Material	Copper Alloy
Contact Plating	Gold, 50 Micro-inches

NOTE: PPMX Contacts, up to 4 per housing

Powerpole® Power (1327FP Series) & Ground Contact (1827 Series)

Ratings for SPEC Pak® Use

Electrical

UL Current Rating (Amperes)	15 to 40
CSA (30°C Rise) (Amperes)	10 to 26
Voltage Rating (AC/DC)	600
Contact Barrel Wire Size (AWG) - Power	20 to 10
- Ground	14 to 10
(mm ²) - Power	0.5 to 4.0
- Ground	1.5 to 4.0
Average Contact Resistance (micro-ohms)	600
Contact Retention Force (lbf)	25
(N)	111
Operating Temperature (°C)	-20° to 105°
(°F)	-4° to 221°
Flammability Rating	UL94 V-0

Mechanical

Mating Cycles	
No Load	
- Tin	1,500
- Silver	10,000
Under Load (Hot Plug 250 mating cycles @ 120V) *	30A
(Hot Plug 250 mating cycles @ 72V) *	45A
Mechanical Shock (50 g)	Mil Standard 202 213 Cond. A
Vibration (10 g)	Mil Standard 202 204 Cond. A

Material

Housing Material	Polycarbonate
Touch Safe (Power / Signal Housing)	UL1977 Sec. 10.2
Contact Material	Copper
Contact Plating	Tin or Silver

* Hot Plug testing completed with individual Powerpole® housings

NOTE: Agency approvals - TUV (contact customer service) / Patents



Part Number Configurator

PART NUMBER PLAN

SPEC Pak® Series (1 Fixed Character)	Shell Color (1 Character)	Shell Style (1 Character)	Dash	Shell Size (mm) (3 Characters)	Insert Arrangement (3 Characters)
S	K	2	-	050	B04
S = SPEC Pak® Series	K = Black	1 = Inline Receptacle 2 = Panel Mount Receptacle 6 = Straight Plug		050 = 50 mm - 4 Pole Shell	B04 = PP15/45 Housing (any type), 4 Pole

PLUG KIT

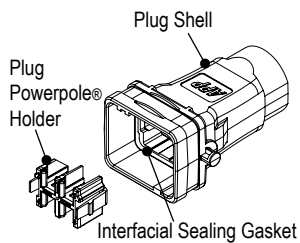

PANEL MOUNT RECEPTACLE KIT

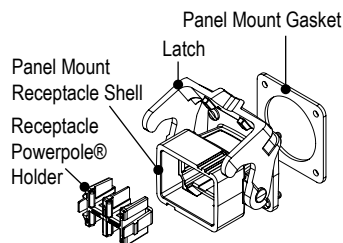

INLINE RECEPTACLE KIT

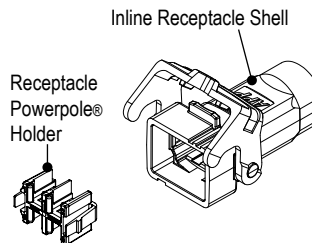

IP68 SEALING COVER KIT

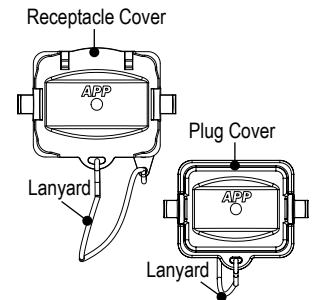

NOTE:

- Mounting hardware (4 each - M3 or #4 screws) not included
- Recommended torque for mounting hardware is 2½ to 4 in-lbf (0.28 to 0.45 Nm)

ORDERING INFORMATION

SPEC Pak® Kits

Part Number	Description
SK6-050B04	Plug kit - Plug shell (includes interfacial sealing gasket) - Powerpole® holder for plug
SK2-050B04	Panel mount receptacle kit - Panel mount receptacle shell with latch - Powerpole® holder for receptacle - Panel mount gasket for receptacle
SK1-050B04	Inline receptacle kit - Inline receptacle shell with latch - Powerpole® holder for receptacle
SK9P-050	Cover kit for plug - Protective sealing (IP68) cover with lanyard
SK9R-050	Cover kit for inline receptacle - Protective sealing (IP68) cover with lanyard
SK9-050	Cover kit for panel mount receptacle - Protective sealing (IP68) cover with lanyard

Component Replacement Parts

Part Number	Description
114805P1	Panel mount gasket for receptacle
2-8673P1	4 position latch

PART NUMBER PLAN

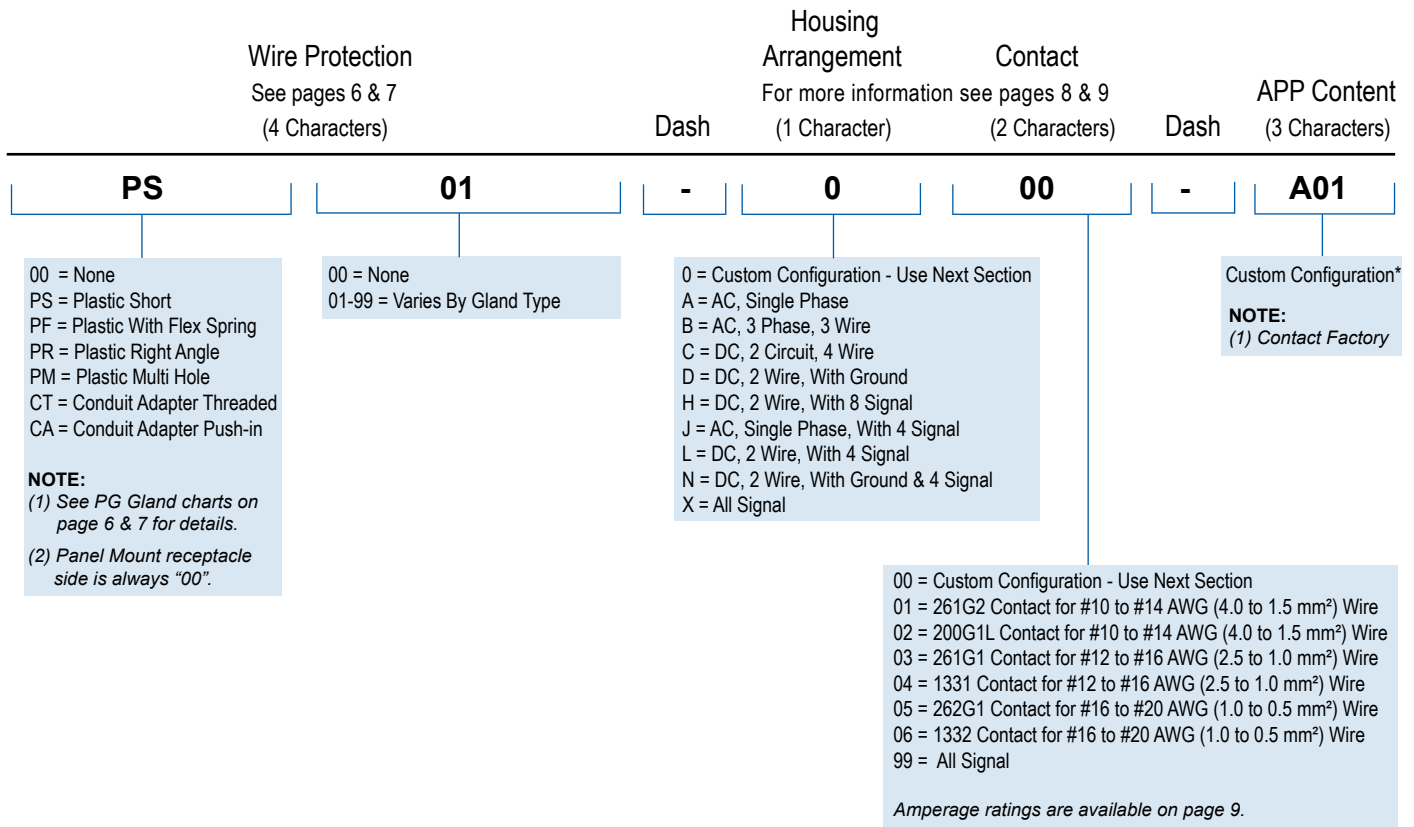

Part Numbering Notes:

- 1) To order SPEC Pak® "Kits Only" (no internal Powerpole® housings or contacts), use part numbering on page 4 only. **Plug Kit Example: SK6-050B04** Powerpole® housings, contacts and wire protection may be ordered separately, see pages 6, 7 and 10 for information.
- 2) To order complete SPEC Pak® connectors kits (including internal Powerpole® housings and contacts) use Part Number Plan across the top of pages 4 and 5. **Standard SPEC Pak® Plug Configuration Example: SK6-050B04PS01-B01**
- 3) To order a custom configuration which is not listed on page 8 and 9, use APP® custom part number configurator on the APP® website, www.andersonpower.com or contact factory.

* Custom configuration may not be UL Recognized.

Wire Protection - PG Gland

SPECIFICATIONS

Material (Push-in Conduit)		Material (All Others)		Torque Requirements	
Shell	Nylon PA	Shell	Nylon PA 66 (UL94 V-2)*	Cable Gland Body to Plug Housing	
Gasket	TPE	Gasket	EPDM	- Hand tighten until snug, tighten additional 1/8 - 1/4 turn with wrench	
Color*	Black	Color*	Black	Sealing Nut to Cable	
Mechanical		Mechanical		- Hand tighten until snug, tighten additional 1/2 - 3/4 turn with wrench	
Operating Temp	-30°C to 100°C (-22°F to 212°F)	Operating Temp	-40°C to 105°C (-40°F to 221°F)		
IP Rating	IP68	IP Rating	IP68		
Thread Type	PG	UV Rating	Equivalent to UL746C F1		
		Thread Type	PG		

* Contact factory for UL94 V-0 material

NOTE: Only UL listed cable glands are UL recognized components when used with SPEC Pak® connector(s).

STRAIGHT PLASTIC SHORT THREAD TYPE - STD PACK 50 / UL LISTED

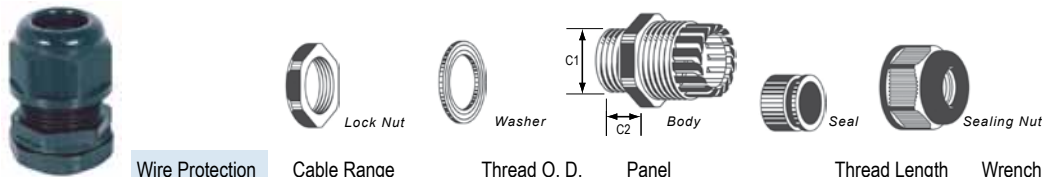

APP® P/N	Wire Protection Designation (4 Characters)	Cable Range Wire Outer Dia. mm (in)	Thread O.D. C1 mm (in)	Panel Mounting Hole mm (in)	Thread Length C2 mm (in)	Wrench Size Lock Nut (mm)	Wrench Size Sealing Nut (mm)
PS1P16-10X	PS01	11.2 - 5.5 (0.44 - 0.22)	22.5 (0.89)	22.5 - 22.8 (0.89 - 0.90)	10.0 (0.39)	30	27
PS1P16-14X	PS02	14.1 - 8.0 (0.56 - 0.31)	22.5 (0.89)	22.5 - 22.8 (0.89 - 0.90)	10.0 (0.39)	30	27

STRAIGHT PLASTIC WITH FLEX SPRING - STD PACK 50 / UL LISTED

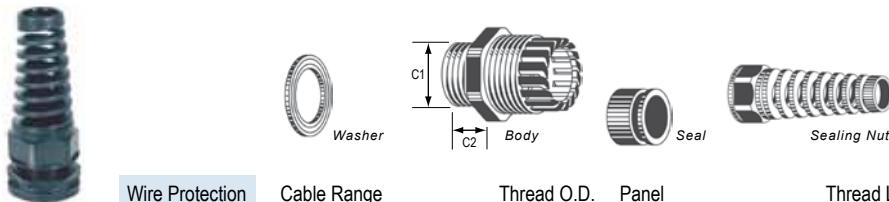

APP® P/N	Wire Protection Designation (4 Characters)	Cable Range Wire Outer Dia. mm (in)	Thread O.D. C1 mm (in)	Panel Mounting Hole mm (in)	Thread Length C2 mm (in)	Wrench Size Lock Nut (mm)	Wrench Size Sealing Nut (mm)
PF1P16-10X	PF01	11.2 - 5.5 (0.44 - 0.22)	22.5 (0.89)	22.5 - 22.8 (0.89 - 0.90)	11.0 (0.43)	30	27
PF1P16-13X	PF02	13.8 - 8.0 (0.54 - 0.31)	22.5 (0.89)	22.5 - 22.8 (0.89 - 0.90)	11.0 (0.43)	30	27

RIGHT ANGLE - STD PACK 50 / UL LISTED

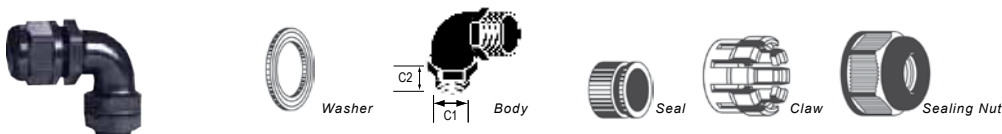

APP® P/N	Wire Protection Designation (4 Characters)	Cable Range Wire Outer Dia. mm (in)	Thread O.D. C1 mm (in)	Panel Mounting Hole mm (in)	Thread Length C2 mm (in)	Wrench Size Lock Nut (mm)	Wrench Size Sealing Nut (mm)
PR1P16-10X	PR01	11.0 - 7.0 (0.43 - 0.28)	22.5 (0.89)	22.5 - 22.8 (0.89 - 0.90)	12.0 (0.47)	30	27
PR1P16-13X	PR02	13.0 - 8.0 (0.51 - 0.31)	22.5 (0.89)	22.5 - 22.8 (0.89 - 0.90)	12.0 (0.47)	30	27

LOCK NUT FOR PG 16 CABLE GLANDS



Lock Nut

APP® P/N	Wrench Size Lock Nut (mm)	Std. Pkg. Size
124G31	30	50

STRAIGHT PLASTIC MULTI-HOLE TYPE - STD PACK 50 / NOT UL LISTED

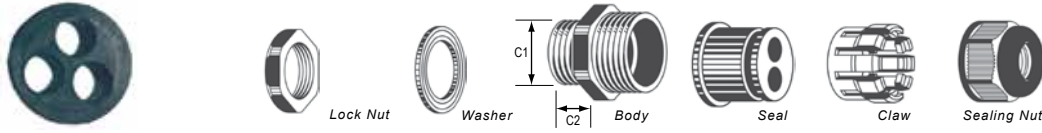

APP® P/N	Wire Protection Designation (4 Characters)	Number of Holes	Cable Range Wire Outer Dia. mm (in)	Thread O.D. C1 mm (in)	Panel Mounting Hole mm (in)	Thread Length C2 mm (in)	Wrench Size Lock Nut (mm)	Wrench Size Sealing Nut (mm)
PS2P16-3X	PM21	2	3.5 - 2.5 (0.14 - 0.10)	22.5 (0.89)	22.5 - 22.8 (0.89 - 0.90)	11.0 (0.43)	30	27
PS2P16-4X	PM22	2	4.3 - 3.3 (0.17 - 0.13)	22.5 (0.89)	22.5 - 22.8 (0.89 - 0.90)	11.0 (0.43)	30	27
PS2P16-6X	PM23	2	6.1 - 4.3 (0.24 - 0.17)	22.5 (0.89)	22.5 - 22.8 (0.89 - 0.90)	11.0 (0.43)	30	27
PS3P16-3X	PM31	3	3.6 - 2.6 (0.14 - 0.10)	22.5 (0.89)	22.5 - 22.8 (0.89 - 0.90)	11.0 (0.43)	30	27
PS3P16-5X	PM32	3	5.2 - 3.5 (0.20 - 0.14)	22.5 (0.89)	22.5 - 22.8 (0.89 - 0.90)	11.0 (0.43)	30	27
PS4P16-2X	PM41	4	2.5 - 1.6 (0.10 - 0.06)	22.5 (0.89)	22.5 - 22.8 (0.89 - 0.90)	11.0 (0.43)	30	27
PS4P16-3X	PM42	4	3.6 - 2.5 (0.14 - 0.10)	22.5 (0.89)	22.5 - 22.8 (0.89 - 0.90)	11.0 (0.43)	30	27
PS4P16-4X	PM43	4	4.8 - 3.4 (0.19 - 0.13)	22.5 (0.89)	22.5 - 22.8 (0.89 - 0.90)	11.0 (0.43)	30	27
PS5P16-2X	PM51	5	2.1 - 1.3 (0.08 - 0.05)	22.5 (0.89)	22.5 - 22.8 (0.89 - 0.90)	11.0 (0.43)	30	27
PS5P16-3X	PM52	5	3.1 - 2.0 (0.12 - 0.08)	22.5 (0.89)	22.5 - 22.8 (0.89 - 0.90)	11.0 (0.43)	30	27
PS5P16-4X	PM53	5	4.1 - 3.0 (0.16 - 0.12)	22.5 (0.89)	22.5 - 22.8 (0.89 - 0.90)	11.0 (0.43)	30	27
PS6P16-2X	PM61	6	2.0 - 1.3 (0.08 - 0.05)	22.5 (0.89)	22.5 - 22.8 (0.89 - 0.90)	11.0 (0.43)	30	27
PS6P16-3X	PM62	6	3.0 - 2.0 (0.12 - 0.08)	22.5 (0.89)	22.5 - 22.8 (0.89 - 0.90)	11.0 (0.43)	30	27

STRAIGHT CONDUIT ADAPTER THREAD TYPE - STD PACK 50 / NOT UL LISTED

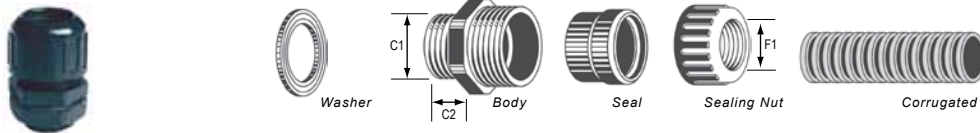

APP® P/N	Wire Protection Designation (4 Characters)	Max. Joint F1 mm (in)	Thread O.D. C1 mm (in)	Panel Mounting Hole mm (in)	Thread Length C2 mm (in)	Wrench Size Lock Nut (mm)	APP® Conduit P/N	Conduit Trade Size
CT1P16-15X	CT01	16.0 (0.63)	22.5 (0.89)	22.5 - 22.8 (0.89 - 0.90)	11.0 (0.43)	30	NGN - 12B	OD15.8
CT1P16-18X	CT02	18.3 (0.72)	22.5 (0.89)	22.5 - 22.8 (0.89 - 0.90)	11.0 (0.43)	30	NGN - 14B	-
CT1P16-21X	CT03	22.0 (0.87)	22.5 (0.89)	22.5 - 22.8 (0.89 - 0.90)	11.0 (0.43)	30	NGN - 17B	OD21.2

STRAIGHT CONDUIT PUSH-IN TYPE - STD PACK 50 / NOT UL LISTED

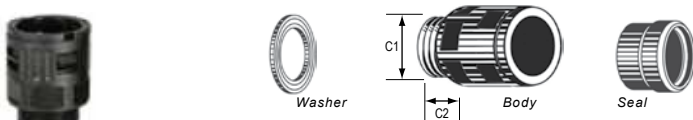

APP® P/N	Wire Protection Designation (4 Characters)	Thread O.D. C1 mm (in)	Panel Mounting Hole mm (in)	Thread Length C2 mm (in)	Wrench Size Lock Nut (mm)	Wrench Size Sealing Nut (mm)	APP® Conduit P/N	Conduit Trade Size
CAP16-15X	CA01	22.5 (0.89)	22.5 - 22.8 (0.89 - 0.90)	10.0 (0.39)	30	21	NGN - 12B	OD15.8
CAP16-18X	CA02	22.5 (0.89)	22.5 - 22.8 (0.89 - 0.90)	10.0 (0.39)	30	21	-	OD18.5
CAP16-21X	CA03	22.5 (0.89)	22.5 - 22.8 (0.89 - 0.90)	10.0 (0.39)	30	27	NGN - 17B	OD21.2
CAP16-28X	CA04	22.5 (0.89)	22.5 - 22.8 (0.89 - 0.90)	12.0 (0.47)	30	34	NGN - 23B	OD28.5

For R/A versions contact Factory

CORRUGATED NYLON PLASTIC TUBING

APP® P/N	Conduit I. D. mm (in)	Conduit O. D. mm (in)	Conduit Size	Trade Size (mm)	Std. Pkg. Meters (Feet)
NGN - 12B	11.8 (0.46)	15.8 (0.62)	3/8"	OD15.8	50 (164)
NGN - 14B	13.8 (0.54)	17.8 (0.70)	-	-	50 (164)
NGN - 17B	16.7 (0.66)	21.2 (0.83)	1/2"	OD21.2	50 (164)
NGN - 23B	21.7 (0.85)	28.5 (1.12)	3/4"	OD28.5	50 (164)

TUBING CUTTER



APP® P/N	Description	Range (mm)
TM0002	Corrugated Plastic Tubing Cutter	Up to OD 34.5

Standard Housing Arrangements & Contacts

HOUSING ARRANGEMENTS FOR POWER, SIGNAL & GROUND CONNECTORS

ARRANGEMENTS REPRESENT FRONT VIEW OF RECEPTACLE

Custom configurations may be created using APP's part number configurator at www.andersonpower.com

E = Empty

1327 Series = Power

1827 Series = Ground

4800 Series = Signal

0 Custom Configuration

AC Single Phase

A	1327G6FP	E
	1327G7FP	1827G1

AC 3 Phase, 3 Wire

B	1327G6FP	1327FP
	1327G7FP	1827G1

DC 2 Circuit, 4 Wire

C	1327G6FP	1327G6FP
	1327FP	1327FP

DC 2 Wire With Ground

D	1327G6FP	1327FP
	E	1827G1

DC 2 Wire With 8 Signal

H	4827G6	4827G6
	1327G6FP	1327FP

AC Single Phase With 4 Signal

J	1327G6FP	4827G6
	1327G7FP	1827G1

DC 2 Wire With 4 Signal

L	1327G6FP	1327FP
	E	4827G6

DC 2 Wire With Ground & 4 Signal

N	1327G6FP	1327FP
	4827G6	1827G1

All Signal

X	4827G6	4827G6
	4827G6	4827G6

CONTINUOUS CURRENT RATINGS - POWER CONTACT CODE SELECTION

Contact Code	Power Contact	Housing Configuration	Wire Size / Current Rating					
			#10	#12	#14	#16	#18	#20
00	Contacts Purchased Separately							
01	261G2	A - D	25/38	20/30	15/25	-	-	-
		H,J,L,N	26/40	25/35	17/27	-	-	-
02	200G1L	A - D	23/35	18/28	15/23	-	-	-
		H,J,L,N	24/37	23/32	15/25	-	-	-
03	261G1	A - D	-	20/30	15/25	11/16	-	-
		H,J,L,N	-	25/35	17/27	13/20	-	-
04	1331	A - D	-	16/25	15/23	12/18	-	-
		H,J,L,N	-	17/27	17/25	13/20	-	-
05	262G1	A - D	-	-	-	11/16	8/13	6/9
		H,J,L,N	-	-	-	13/20	10/15	7/10
06	1332	A - D	-	-	-	12/18	8/13	6/9
		H,J,L,N	-	-	-	13/20	10/15	7/10

NOTES:

- Current ratings:
 - First number represents current rating per pole for 30°C temperature rise (25 / 38)
 - Second number is the maximum recommended current per pole based on a 25°C ambient (25 / 38)
- Configuration H - N based on signal contacts crimped to #20 AWG wire and carrying 1 amp
- ☐ Denotes wire size not appropriate for power contact
- Shaded boxes are US File No. E26226 pending.
- 1827G1 housing should be used with 1830G1 or 1830G2 ground contact, depending on primary contacts (see chart above). All signal housings (4850G6) come with two 4802G3 and two 4803G3 contacts.

HOLDER LOCATIONS (VIEWS)



TEMPERATURE CHART

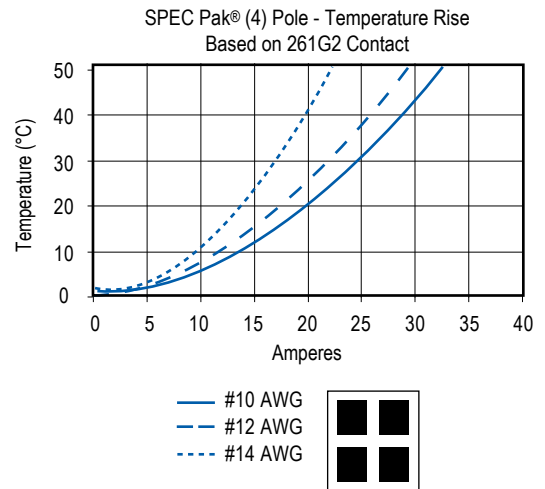

Individual Components

POWERPOLE® HOUSINGS & CONTACTS

Fingerproof PP15/45 Housing Only

Package Quantity:

Standard, 100 pieces - Bulk, 1,000 pieces

Standard Part Number	Bulk Part Number	Description
1327FP	1327FP-BK	Red Housing
1327G5FP	1327G5FP-BK	Green Housing
1327G6FP	1327G6FP-BK	Black Housing
1327G7FP	1327G7FP-BK	White Housing
1327G8FP	1327G8FP-BK	Blue Housing
1327G16FP	1327G16FP-BK	Yellow Housing

Standard PP 15/45 Housing Only

Package Quantity:

Standard, 100 pieces - Bulk, 1,000 pieces

Standard Part Number	Bulk Part Number	Description
1327	1327-BK	Red Housing
1327G5	1327G5-BK	Green Housing
1327G6	1327G6-BK	Black Housing
1327G7	1327G7-BK	White Housing
1327G8	1327G8-BK	Blue Housing
1327G16	1327G16-BK	Yellow Housing
1327G17	1327G17-BK	Orange Housing
1327G18	1327G18-BK	Gray Housing
1327G21	1327G21-BK	Brown Housing
1327G22	1327G22-BK	Pink Housing
1327G23	1327G23-BK	Purple Housing

Premate Ground PP15/45 Housing Only

Package Quantity:

Standard, 100 pieces - Bulk, 1,000 pieces

Standard Part Number	Bulk Part Number	Description
1827G1	1827G1-BK	Green Housing

Premate Ground Contacts

Loose Piece

Package Quantity 100

Part Number	Description
#10 to #14 AWG (4 to 1.5 mm ²)	
1830G1-LPBK	Singulated-LD-Tin Plate
1830G2-LPBK	Singulated-LD-Silver Plate

Reel

Package Quantity 5,000

Part Number	Description
#10 to #14 AWG (4 to 1.5 mm ²)	
1830G1	Reel-LD-Tin Plate
1830G2	Reel-LD-Silver Plate

15/45 Powerpole® Contacts

Loose Piece

Package Quantity:

Standard, 100 pieces - Bulk, 1,000 pieces

Standard Part Number	Bulk Part Number	Description
#16 to #20 AWG (1.0 to 0.5 mm ²)		
1332	1332-BK	Individual-LD-Silver Plate
262G1-LPBK	-	Singulated Reel-LD-Tin Plate
262G2-LPBK	-	Singulated Reel-LD-Silver Plate

#12 to #16 AWG (2.5 to 1.0 mm²)

1331	1331-BK	Individual-LD-Silver Plate
261G1-LPBK	-	Singulated Reel-LD-Tin Plate

#10 to #14 AWG (4 to 1.5 mm²)

261G2-LPBK	-	Singulated Reel-LD-Tin Plate
261G3-LPBK	-	Singulated Reel-LD-Silver Plate
200G1L-LPBK	-	Superflex, Sing. Reel-LD-Tin Plate

Reel - 15/45 Powerpole® Contacts

Package Quantity 5,000

Part Number	Description
#16 to #20 AWG (1.0 to 0.5 mm ²)	
262G1	Reel-LD-Tin Plate
262G2	Reel-LD-Silver Plate

#12 to #16 AWG (2.5 to 1.0 mm²)

261G1	Reel-LD-Tin Plate
-------	-------------------

#10 to #14 AWG (4 to 1.5 mm²)

261G2	Reel-LD-Tin Plate
261G3	Reel-LD-Silver Plate

#10 to #14 AWG (6 to 1.5mm²)

200G1L	SuperFlex, Reel-LD-Tin Plate
--------	------------------------------

NOTE:

LD - Low Detent

CONTACT STYLES

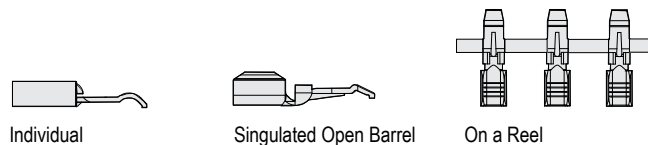

PPMX (4800 SERIES) HOUSING & CONTACTS

PPMX Housing

Package Quantity
Standard, 25 pieces - Bulk, 1,000 pieces

Standard	Bulk	
Part Number	Part Number	Description
4827G6	4827G6-BK	Black two piece housing

PPMX Contacts

Package Quantity
Standard, 50 pieces - Bulk, 2,000 pieces

Loose Piece

#20 to #24 AWG (0.50 to 0.25 mm²)

Standard	Bulk	
Part Number	Part Number	Description
4802G3	4802G3-BK	Socket, Gold, 50 Micro-inches
4803G3	4803G3-BK	Pin, Gold, 50 Micro-inches

PPMX Housing & Contact Kits

Package Quantity
Standard, 100 pieces

1 Black two piece housing, 2 Male Contacts,
2 Female Contacts

Standard	Bulk	
Part Number	Part Number	Description
4850G6	-	50 Micro-inches Gold Plated Contacts - Pin & Socket

PP15/45 POWERPOLE® HOUSING STYLES

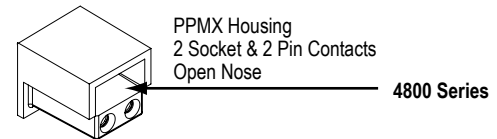
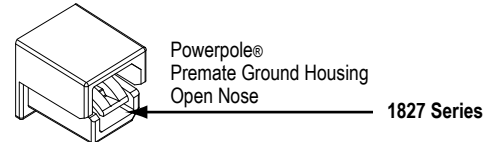
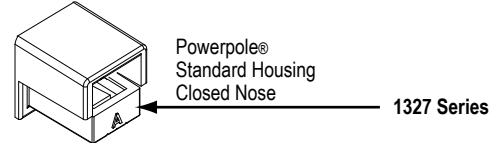

APPLICATION TOOLING - POWERPOLE® 15 / 45 CONTACTS

Loose Piece Tin Part Number	Loose Piece Silver Part Number	Hand Tool * or Pneumatic Tool *	Reeled Tin Part Number **	Reeled Silver Part Number **	ATS Applicator	
N/A	1332	1309G2 or 1309G8 **	N/A	N/A	N/A	
N/A	1331		N/A	N/A	N/A	
262G1-LPBK	262G2-LPBK	1309G3 or 1309G8 ***	262G1	262G2	1385520	
200G2L-LPBK	200G4L-LPBK		200G2L	200G4L	TBD	
261G1-LPBK	261G4-LPBK		261G1	261G4	1385520	
261G2-LPBK	261G3-LPBK		261G2	261G3	1385458	
200G1L-LPBK	200G3L-LPBK		200G1L	200G3L	1385460	
1830G1-LPBK	1830G2-LPBK		1309G6 or 1309G8 ***	1830G1	1830G2	1385460

* All Hand and Pneumatic Tools for use with Loose Piece contacts only.

** All reeled contacts can be ordered singulated (Loose Piece) with the suffix "- LPBK"

*** 1309G8 is a hand tool kit- includes dies and locators to make up 1309G2, 1309G3, & 1309G6

APPLICATION TOOLING - PPMX CONTACTS

Contact Part Number	APP® Hand Tool or	Mil Std. Hand Tool (APP Part #)	+ Positioner	+ Pneumatic Tool for Locator / Turret
4802G3	PM1000G1	M22520/1-01 (TM0001)	No Mil Std. (TL0005)	TP0001
4803G3				

Dimensions

PLUG 4 POSITION FOR PP15/45 HOUSINGS

Top View

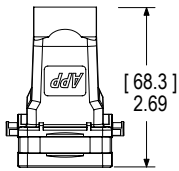

Front View

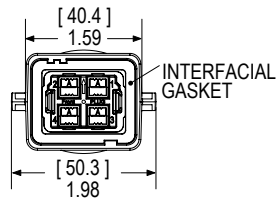

Side View

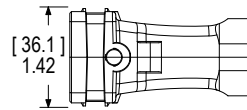

Mated Side View

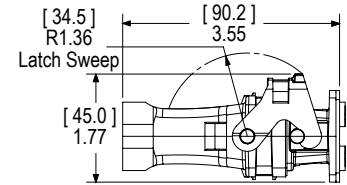

PANEL MOUNT RECEPTACLE 4 POSITION FOR PP15/45 HOUSINGS

Panel Cut Out

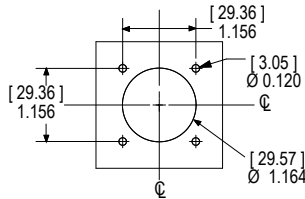

PANEL CUT OUT \varnothing
(SAME AS 26482 & 5015 SHELL SIZE 20)

Front View

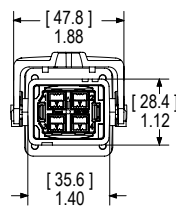

Side View

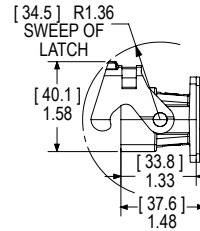

Back View

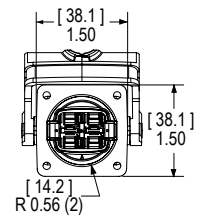

INLINE RECEPTACLE 4 POSITION FOR PP15/45 HOUSINGS

Top View

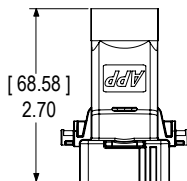

Front View

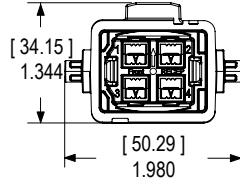

Side View

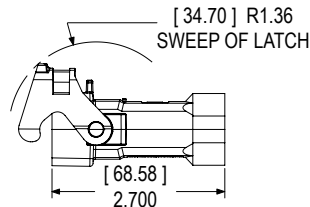

Mated Side View

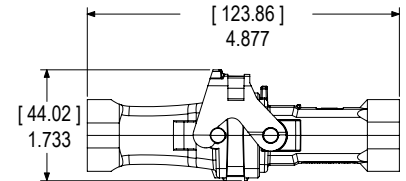

PG GLANDS

PS - Plastic Short

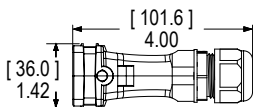

CT - Threaded Conduit Adapter

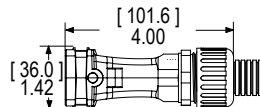

CA - Push-in Conduit Adapter

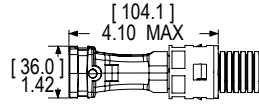

PF - Plastic Flex PG

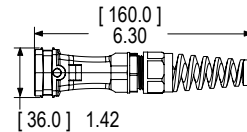

PR - Right Angle

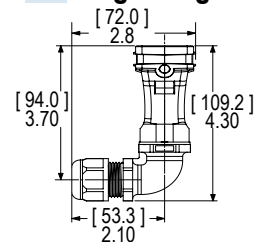

RECEPTACLE COVER KIT

Front View

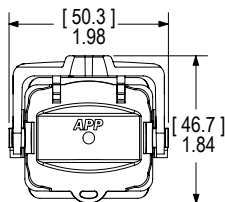

Side View

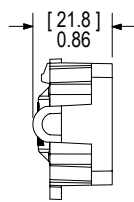

Mated Side View

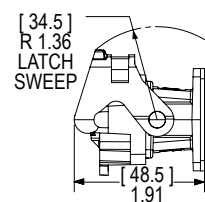

PLUG COVER KIT

Front View

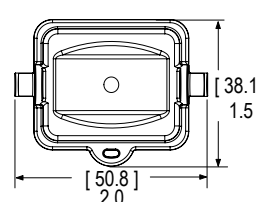

Side View

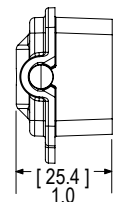

All Data Subject To Change Without Notice Patents

15013 DS-4PSPAK REV02

HEADQUARTERS: Anderson Power Products®, 13 Pratts Junction Road, Sterling, MA 01564-2305 USA T:978-422-3600 F:978-422-0128

EUROPE: Anderson Power Products® Ltd., Unit 3, Europa Court, Europa Boulevard, Westbrook, Warrington, Cheshire, WA5 7TN United Kingdom T: +44 (0) 1925 428390 F: +44 (0) 1925 520203

ASIA / PACIFIC: IDEAL Anderson Asia Pacific Ltd., Unit 922-928 Topsail Plaza, 11 On Sum Street, Shatin N.T., Hong Kong T: +(852) 2636 0836 F: +(852) 2635 9036

CHINA: IDEAL Anderson Technologies (Shenzhen) Ltd., Block A8 Tantou Western Industrial Park, Songgang Baoan District, Shenzhen, P.R. China 518105 T: +(86) 755 2768 2118 F: +(86) 755 2768 2218

TAIWAN: IDEAL Anderson Asia Pacific Ltd., Taiwan Branch, 4F-2, No.116, Dadun 20th St., Situn District, Taichung City 407, Taiwan (R.O.C.) T: +(886) 4 2310 6451 F: +(886) 4 2310 6460

www.andersonpower.com

X-ON Electronics

Largest Supplier of Electrical and Electronic Components

Click to view similar products for [Heavy Duty Power Connectors](#) category:

Click to view products by [Anderson Power Products](#) manufacturer:

Other Similar products are found below :

[647757-1](#) [6643411-1](#) [6646058-2](#) [6646137-1](#) [6646138-1](#) [6646479-1](#) [6646608-1](#) [6646786-1](#) [6646940-1](#) [6651091-1](#) [6651525-1](#) [6651529-1](#)
[6651788-1](#) [696475-1](#) [73000005059](#) [73000005642](#) [765-15-0080A](#) [765-16-0080B](#) [829992-1](#) [902-77-02113](#) [129-1J](#) [AN0024023](#) [E6374G1](#)
[e6389g2](#) [157-43GW8](#) [MS3117-14AC](#) [1643543-1](#) [1650540-1](#) [1651811-2](#) [1766260-1](#) [1766282-1](#) [1766966-1](#) [1791340000](#) [NLDFT-3-BL-L-](#)
[S120-M40A](#) [NLDFT-N-W-L-C240-M40B](#) [NLS-2-R-C240-M40B](#) [NLS-N-W-C240-M40B](#) [NPS-3-BL-T6](#) [1986615-1](#) [2-1589900-8](#) [2199314-1](#)
[KA8102](#) [9300480317](#) [SBS50BRN#6](#) [29131](#) [29652](#) [1646905-1](#) [1648320-1](#) [1648582-1](#) [1650195-2](#)