

## 1200V N-Channel Silicon Carbide Power MOSFET



### 1. Applications

- Asymmetrical Bridge Converter
- Inverter
- Single Switch Forward Flyback

### 2. Features

- Low drain-source on-resistance:  $R_{DS(ON)}=40m\Omega$  (typ.)
- Easy to control Gate switching
- Enhancement mode:  $V_{th} = 2$  to  $4V$

**Table 1 Key Performance Parameters**

Parameter	Value	Unit
$V_{DS} @ T_{j,max}$	1200	V
$R_{DS(on),max}$	60	m $\Omega$
$Q_{g,typ}$	105	nC
$I_{D,pulse}$	152	A

### 3. Packaging and Internal Circuit

Part Name	Package	Marking
ADQ120N040BH	TO-247-4L	ADQ120N040BH
ADW120N040BH	TO-247-3L	ADW120N040BH

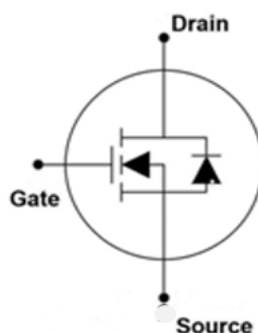
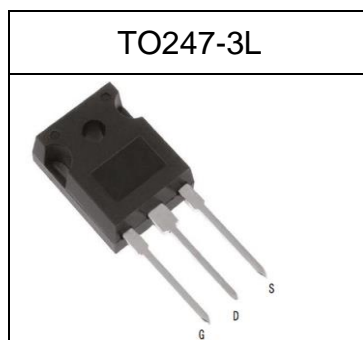
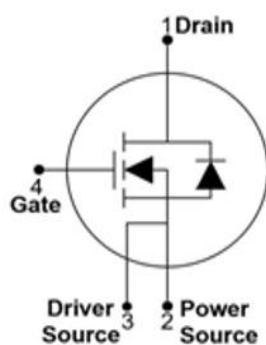
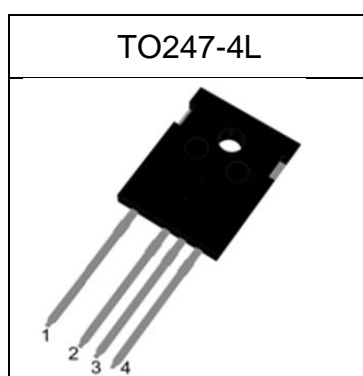

Released

## 1 Maximum ratings

at  $T_j = 25^\circ\text{C}$ , unless otherwise specified

**Table 2 Maximum ratings**

Parameter	Symbol	Values			Unit	Note / Test Condition
		Min.	Typ.	Max.		
Continuous drain current <sup>1)</sup>	$I_D$	-	-	50.5	A	$T_C=25^\circ\text{C}$
		-	-	35	A	$T_C=100^\circ\text{C}$
Avalanche energy, single pulse	$E_{AS}$	-	-	990	mJ	$T_C=25^\circ\text{C}, V_{DD}=50\text{V}, L=10\text{mH}, R_G=25\Omega$
Gate source voltage (dynamic)	$V_{GS}$	-10	-	22	V	Absolute maximum values
Gate source voltage (static)	$V_{GS}$	-5	-	20	V	Recommended operational values
Power dissipation	$P_{tot}$	-	-	273	W	$T_C=25^\circ\text{C}$
Storage temperature	$T_{stg}$	-55	-	175	$^\circ\text{C}$	
Operating junction temperature	$T_j$	-55	-	175	$^\circ\text{C}$	
Soldering Temperature Distance of 1.6mm from case for 10s	$T_L$			260	$^\circ\text{C}$	
Transconductance	GFS	-	19.5	-	S	$V_{DS}=20\text{V } I_{DS}=33.3\text{A}$
			29.6			$V_{DS}=20\text{V } I_{DS}=33.3\text{A}, T_j=175^\circ\text{C}$

<sup>1)</sup>Limited by  $T_{j,max}$ . Maximum Duty Cycle  $D = 0.50$

<sup>2)</sup>Pulse width  $t_p$  limited by  $T_{j,max}$

<sup>3)</sup>Identical low side and high side switch with identical  $R_G$

Released

## 2 Thermal characteristics

Table 3 Thermal characteristics

### TO247

Parameter	Symbol	Values			Unit	Note / Test Condition
		Min.	Typ.	Max.		
Thermal resistance, junction - case	$R_{thJC}$	-	0.55	0.7	°C/W	-
Thermal resistance, junction - ambient	$R_{thJA}$	-	-	36	°C/W	device on PCB, minimal footprint

Released

### 3 Electrical characteristics

at  $T_j=25^\circ\text{C}$ , unless otherwise specified

**Table 4 Static characteristics**

Parameter	Symbol	Values			Unit	Note / Test Condition
		Min.	Typ.	Max.		
Drain-source breakdown voltage	$V_{(BR)DSS}$	1200	-	-	V	$V_{GS}=0V, I_D=100\mu A$
Gate threshold voltage	$V_{(GS)th}$	2	2.7	4	V	$V_{DS}=V_{GS}, I_D=5mA$
Zero gate voltage drain current	$I_{DSS}$	-	-	50	$\mu A$	$V_{DS}=1200V, V_{GS}=0V$
Gate-source leakage current	$I_{GSS+}$	-	-	250	nA	$V_{GS}=22V, V_{DS}=0V$
Gate-source leakage current	$I_{GSS-}$	-	-	-100	nA	$V_{GS}=-10V, V_{DS}=0V$
Drain-source on-state resistance	$R_{DS(on)}$	-	40	60	$m\Omega$	$V_{GS}=20V, I_D=20A, T_j=25^\circ\text{C}$
		-	66	-		$V_{GS}=20V, I_D=20A, T_j=150^\circ\text{C}$
Gate resistance (Intrinsic)	$R_G$	-	5.2	-	$\Omega$	$f=1MHz, \text{open drain}$

**Table 5 Dynamic characteristics**

Parameter	Symbol	Values			Unit	Note / Test Condition
		Min.	Typ.	Max.		
Input capacitance	$C_{iss}$	-	2530	-	pF	$V_{GS}=0V, V_{DS}=1000V, f=1MHz$
Output capacitance	$C_{oss}$	-	110.7	-	pF	
Reverse transfer capacitance	$C_{rss}$	-	7.02	-	pF	
Turn-on delay time	$t_{d(on)}$	-	57.71	-	ns	$V_{DD}=800V, I_D=33.3A, R_G=2.5\Omega;$ $T_j=25^\circ\text{C}$ $V_{GS}=-4/18V L=99\mu H$
Rise time	$t_r$	-	15	-	ns	
Turn-off delay time	$t_{d(off)}$	-	36.56	-	ns	
Fall time	$t_f$	-	9.924	-	ns	
Turn-on Switching Energy	$E_{on}$	-	1079	-	$\mu J$	
Turn-off Switching Energy	$E_{off}$	-	97.71	-	$\mu J$	

**Table 6 Gate charge characteristics**

Parameter	Symbol	Values			Unit	Note / Test Condition
		Min.	Typ.	Max.		
Gate to source charge	$Q_{gs}$	-	33.8	-	nC	$V_{DD}=800V, I_D=30A, V_{GS}=-4/18V$
Gate to drain charge	$Q_{gd}$	-	34.1	-	nC	
Gate charge total	$Q_g$	-	105	-	nC	

Released

Table 7 Reverse diode characteristics

Parameter	Symbol	Values			Unit	Note / Test Condition
		Min.	Typ.	Max.		
Continuous Source Current	$I_{SD}$	-	-	50.5	A	
Diode forward voltage	$V_{SD}$	-	3.6	-	V	$I_S = 20A, V_{GS} = 0V, T_j = 25^\circ C$
Reverse recovery time	$t_{rr}$	-	37.23	-	ns	$V_{GS} = -4 V, I_{SD} = 33.3 A,$ $V_R = 800 V$ $di/dt = 1150 A/\mu s, T_j = 175^\circ C$
Reverse recovery charge	$Q_{rr}$	-	707.6	-	nC	
Peak reverse recovery current	$I_{rrm}$	-	30.55	-	A	

Released

### 4 Electrical characteristics diagram

Diagram 1: Typ. output characteristics

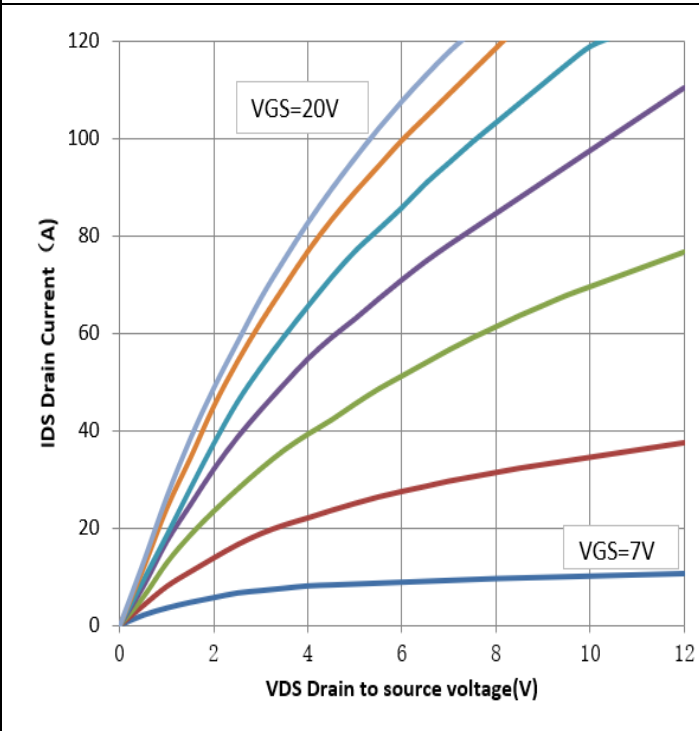

$I_D = f(V_{DS}); T_J = 25^\circ\text{C}$ ; parameter:  $V_{GS}$ ;  $V_{GS} = 7, 9, 11, 13, 15, 18, 20\text{V}$

Diagram 2: Typ. output characteristics

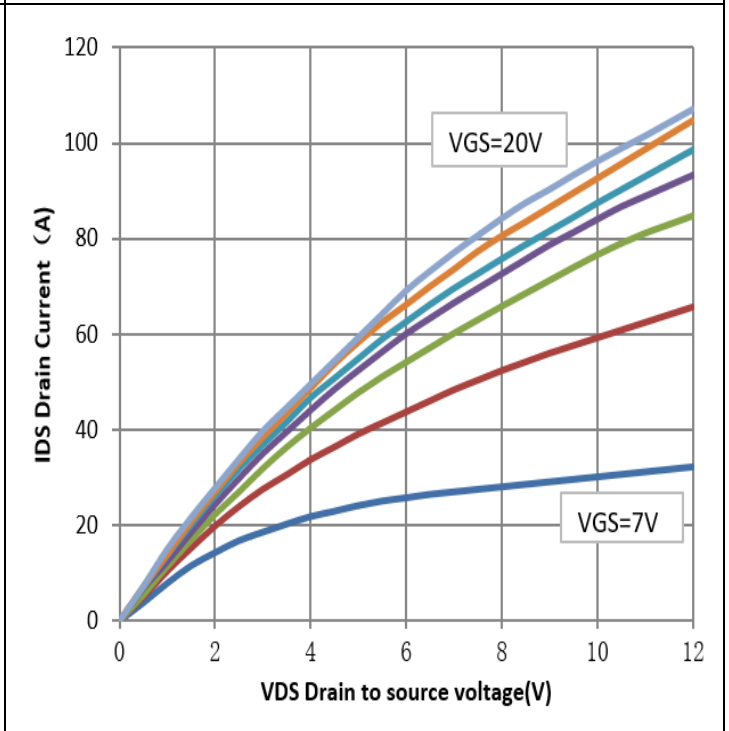

$I_D = f(V_{DS}); T_J = 175^\circ\text{C}$ ; parameter:  $V_{GS}$ ;  $V_{GS} = 7, 9, 11, 13, 15, 18, 20\text{V}$

Diagram 3: Typ. transfer characteristics



$I_D = f(V_{GS}); V_{DS} = 20\text{V}$ ; parameter:  $T_J$

Diagram 4: Typ. gate charge

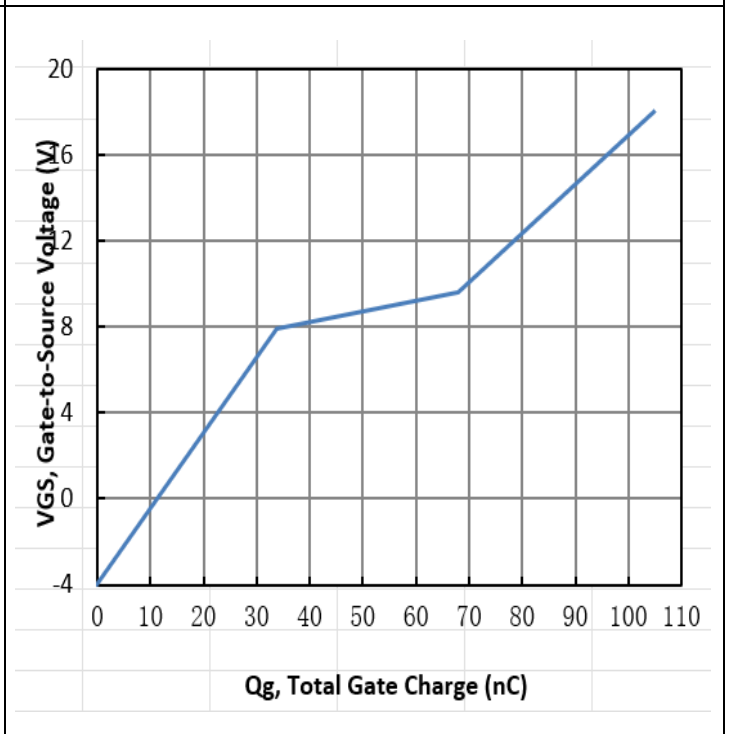

$V_{GS} = f(Q_{gate}); I_D = 30\text{A}$ ;  $V_{BS} = 800\text{V}$ ; turn-on pulse

Released

Diagram 5: Typical gate-source threshold voltage as a function of junction temperature

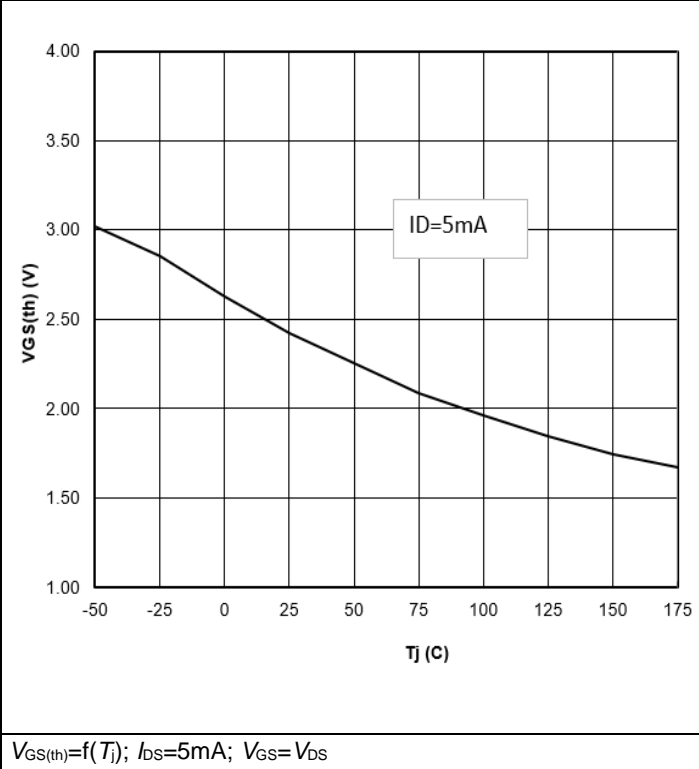

Diagram 6: Typ. Capacitance as a function of drain-source voltage

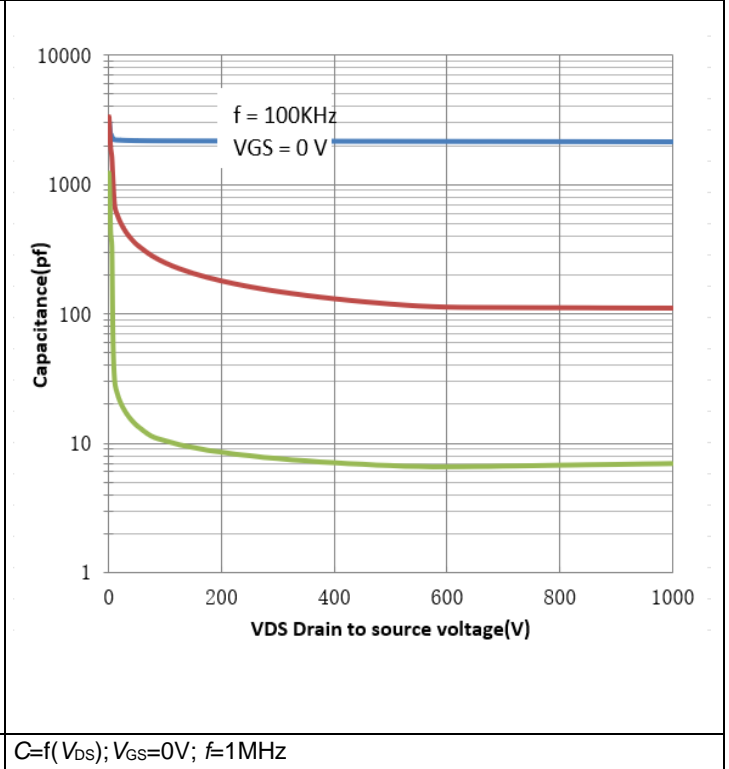

Diagram 7: Normalized on-resistance vs. junction temperature

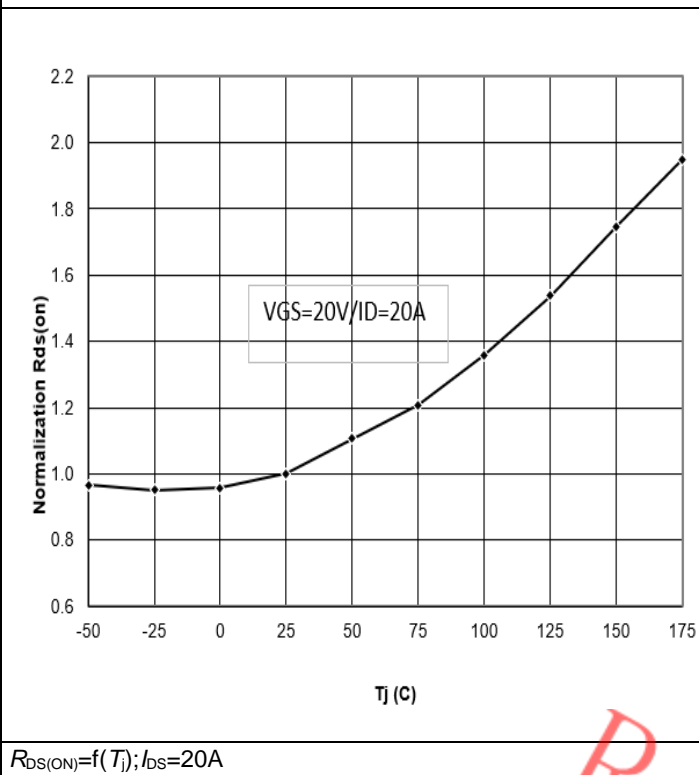
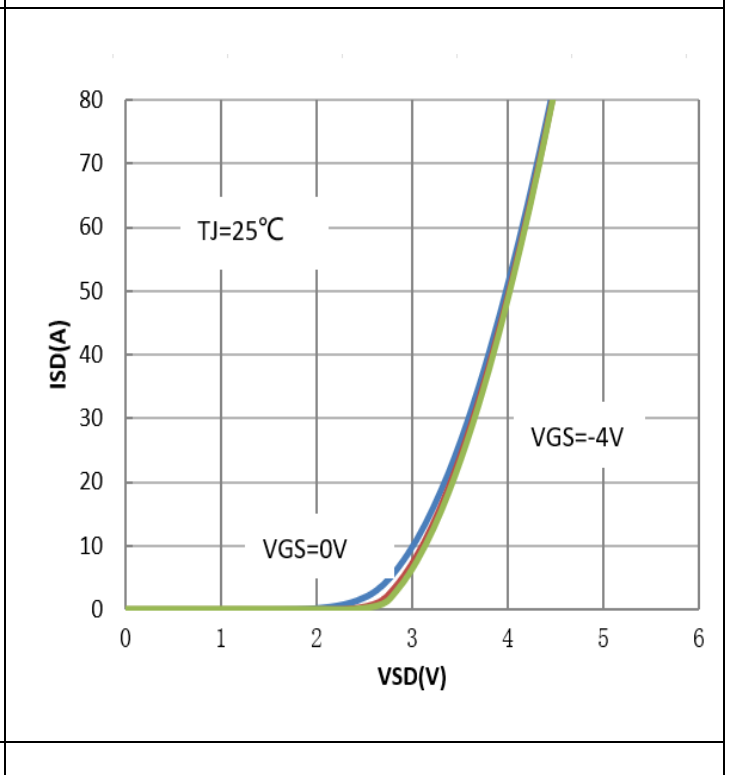
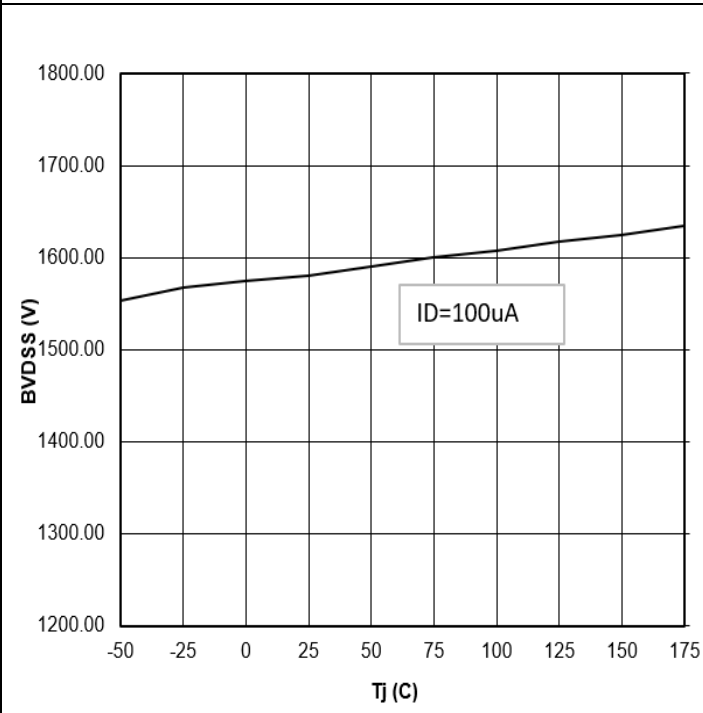

Diagram 8: Typical body diodes Characteristics at 25C



Released

Diagram 9: BVDSS VS junction temperature



$Bvdss=f(T_j)$

Diagram 10: 3rd Quadrant Characteristic at 25 °C

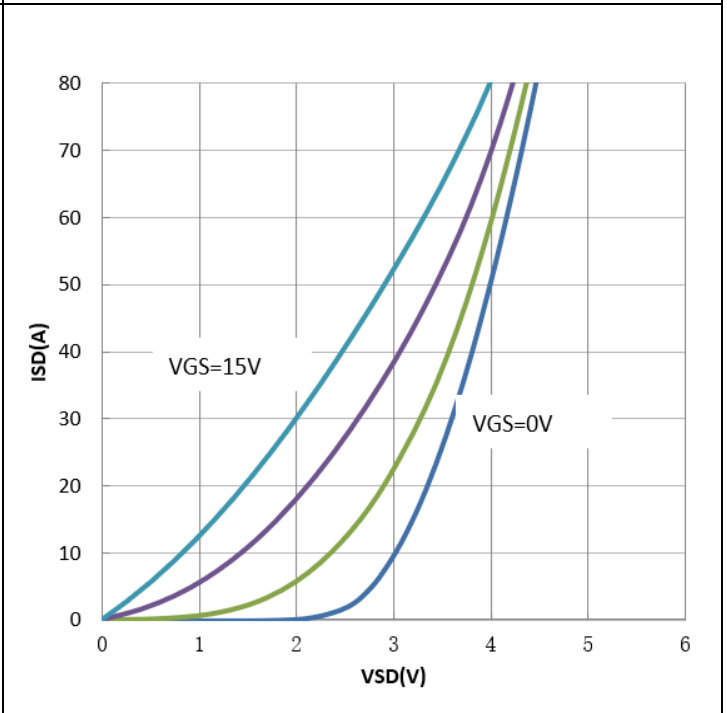

$I_{SD}=f(V_{SD})$

Diagram 11: Safe operating area(SOA)

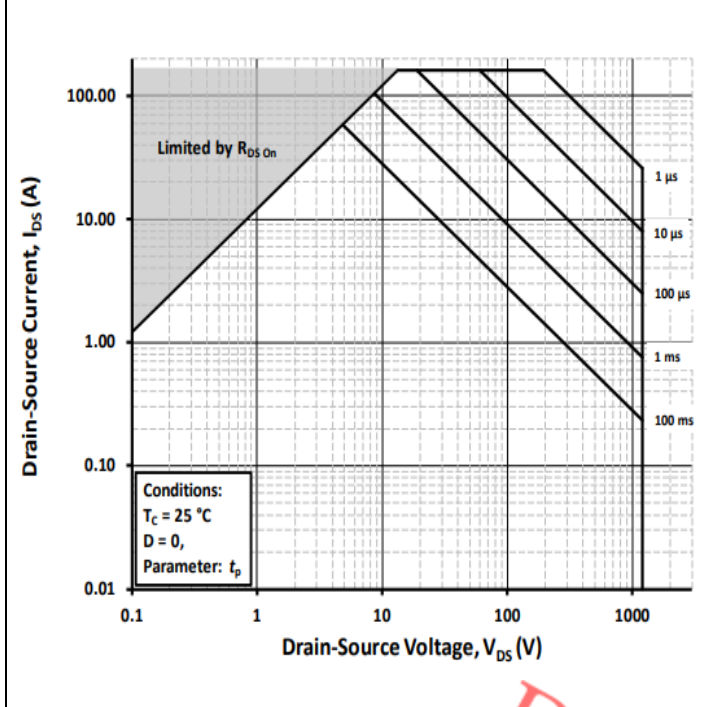

$V_{GS}=0/18V; T_C=25\text{ }^\circ\text{C}; T_J<175\text{ }^\circ\text{C}$

Diagram 12: Power dissipation as a function of case temperature limited by bond wire

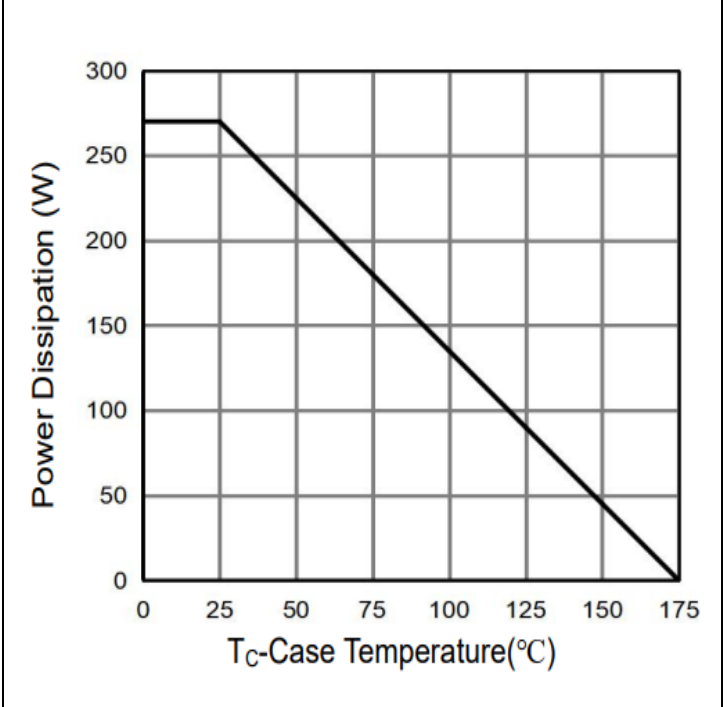

$P_{tot}=f(T_C)$

Released



Diagram 13: Clamped Inductive Switching Energy vs. Drain Current (VDD = 800V)

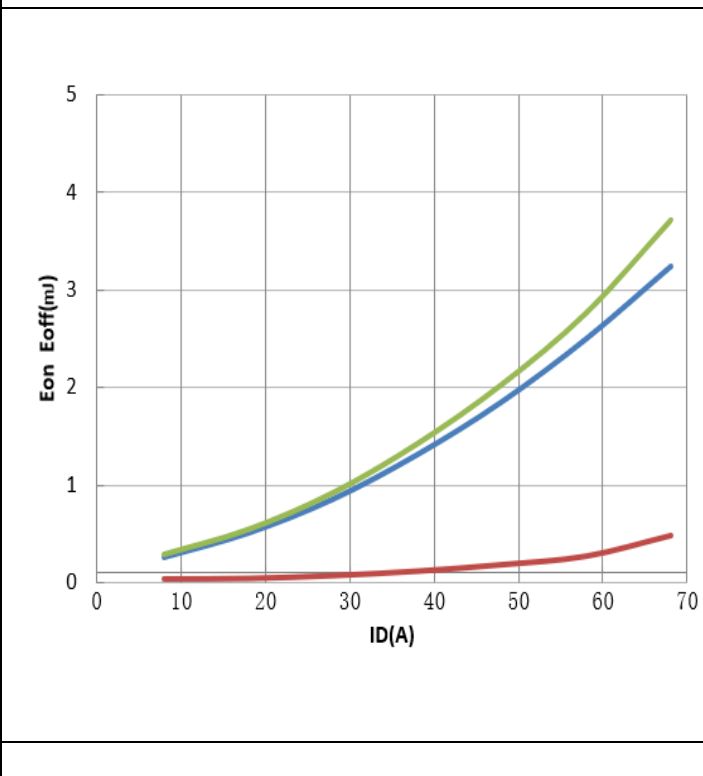

Diagram 14: Clamped Inductive Switching Energy vs. RG(ext)

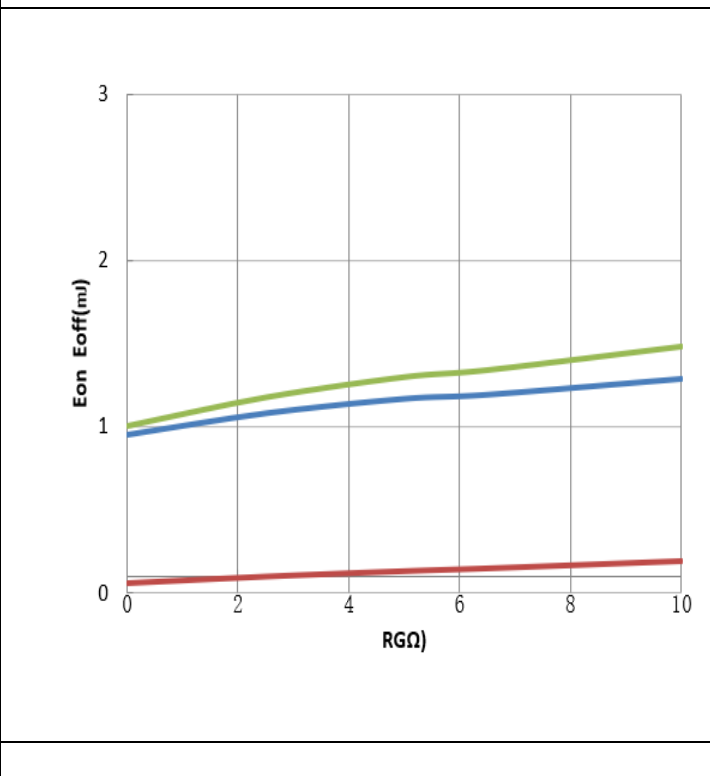

Diagram 15: Clamped Inductive Switching Energy vs. Temperature

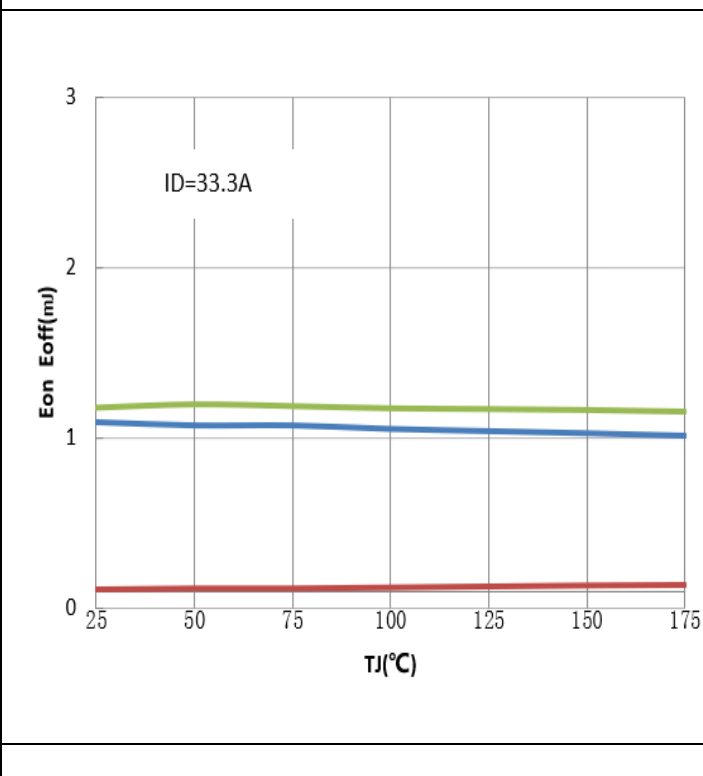

Diagram 16: Switching Times vs. RG(ext)

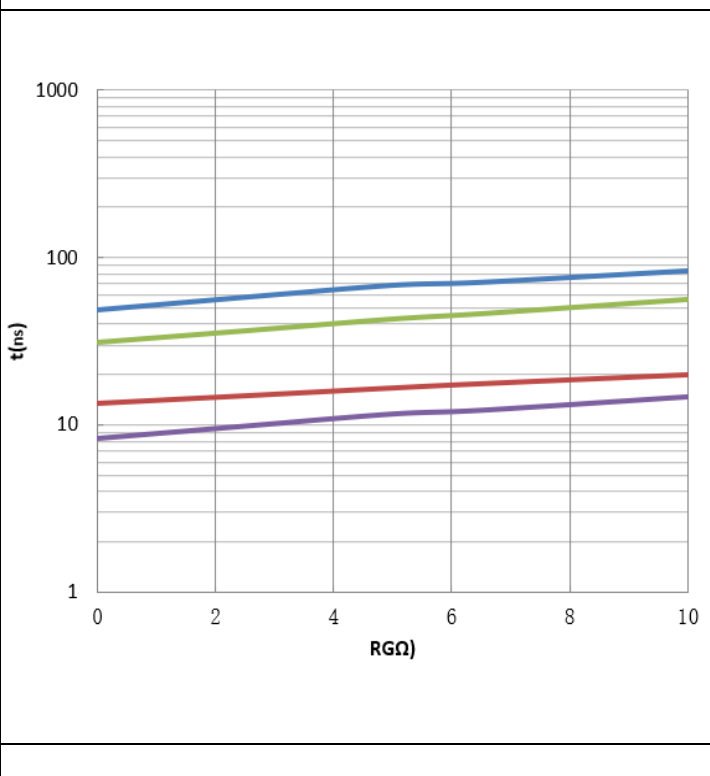
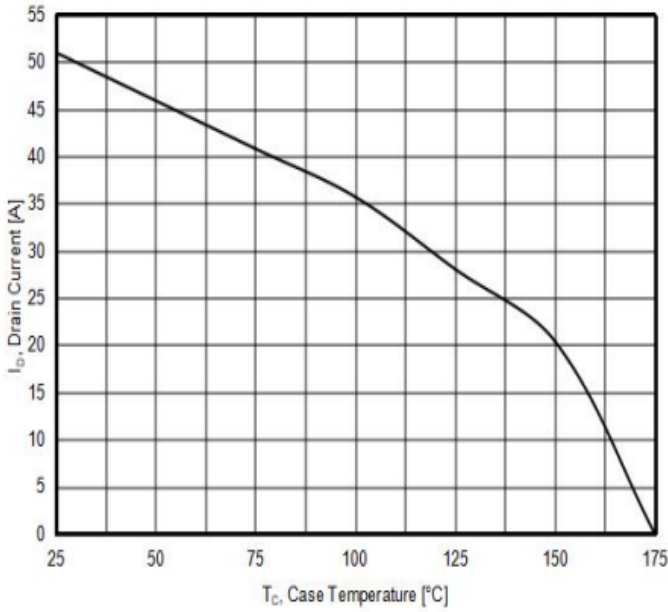
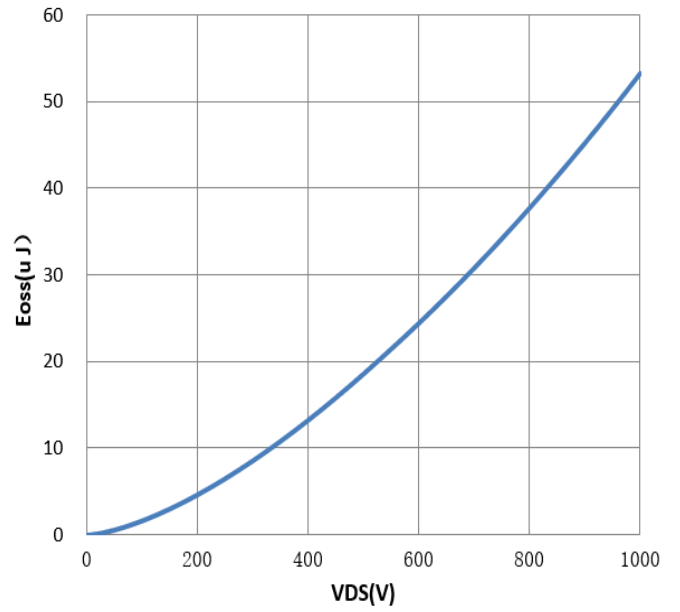

Diagram 17: Continuous Drian Current Derating vs. Case Temperature



$I_{DS} = f(T_C)$

Diagram 18: Output Capacitor Stored Energy



$E_{oss} = f(V_{DS})$

Diagram 19: Max. transient thermal resistance(MOSFET/diodes)

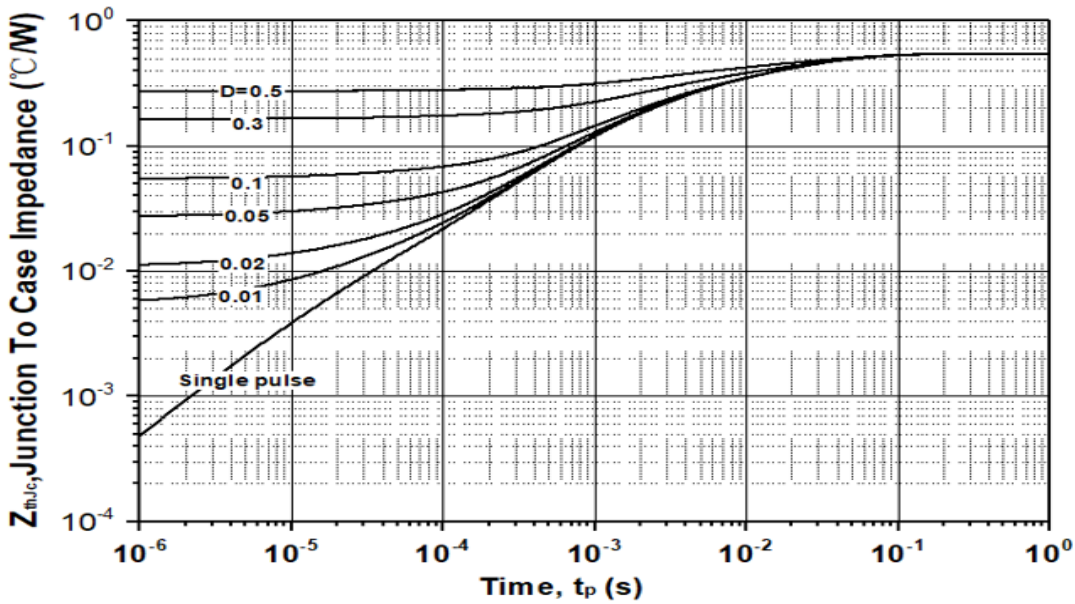

$Z_{th(j-c,max)} = f(t_p), \text{parameter } D = t_p / T$

Released

## 5 Test Circuits

**Table 8 Diode characteristics**

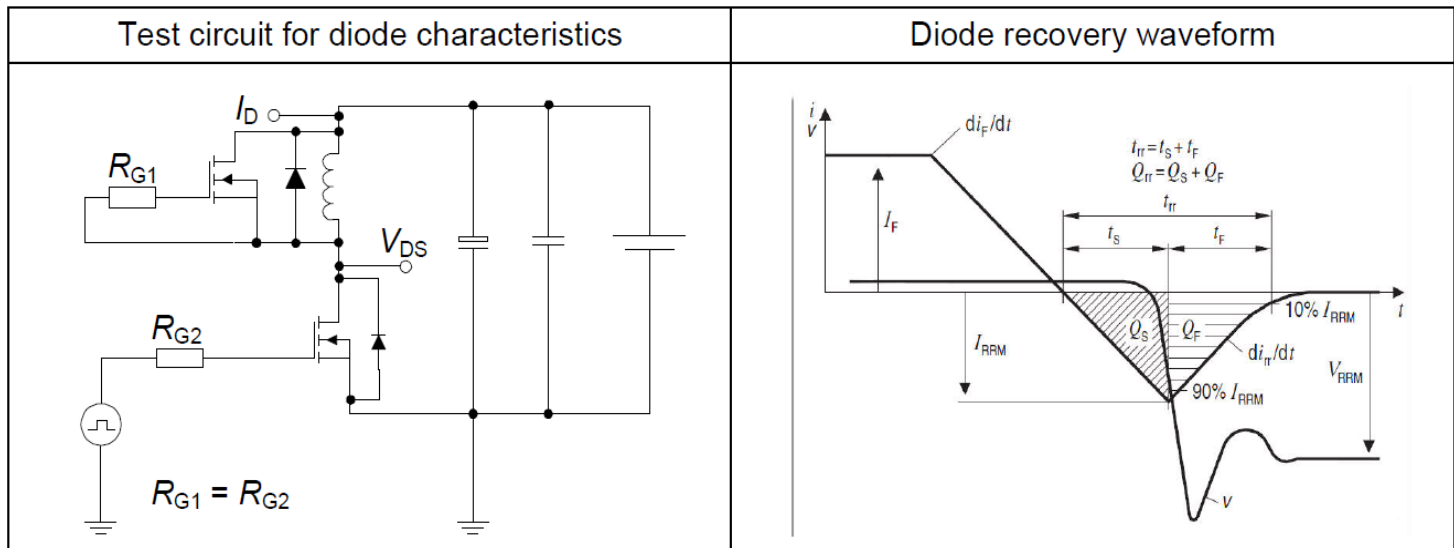

**Table 9 Switching times**

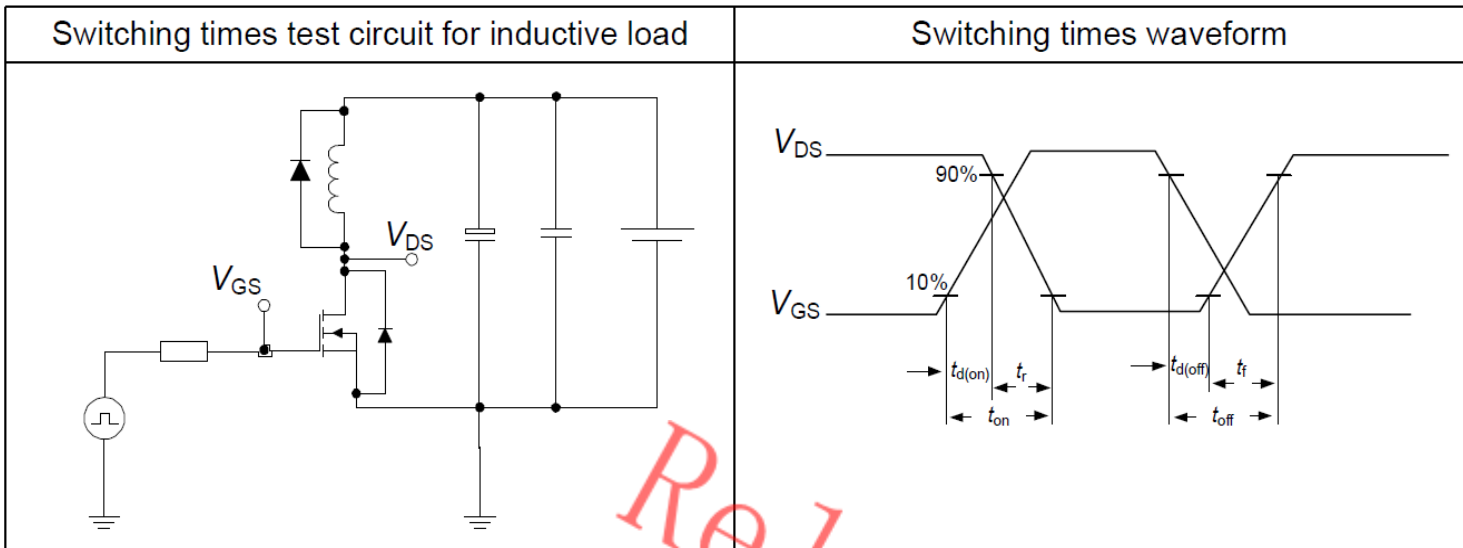

Released

## 6 Package Outlines

TO-247-4L

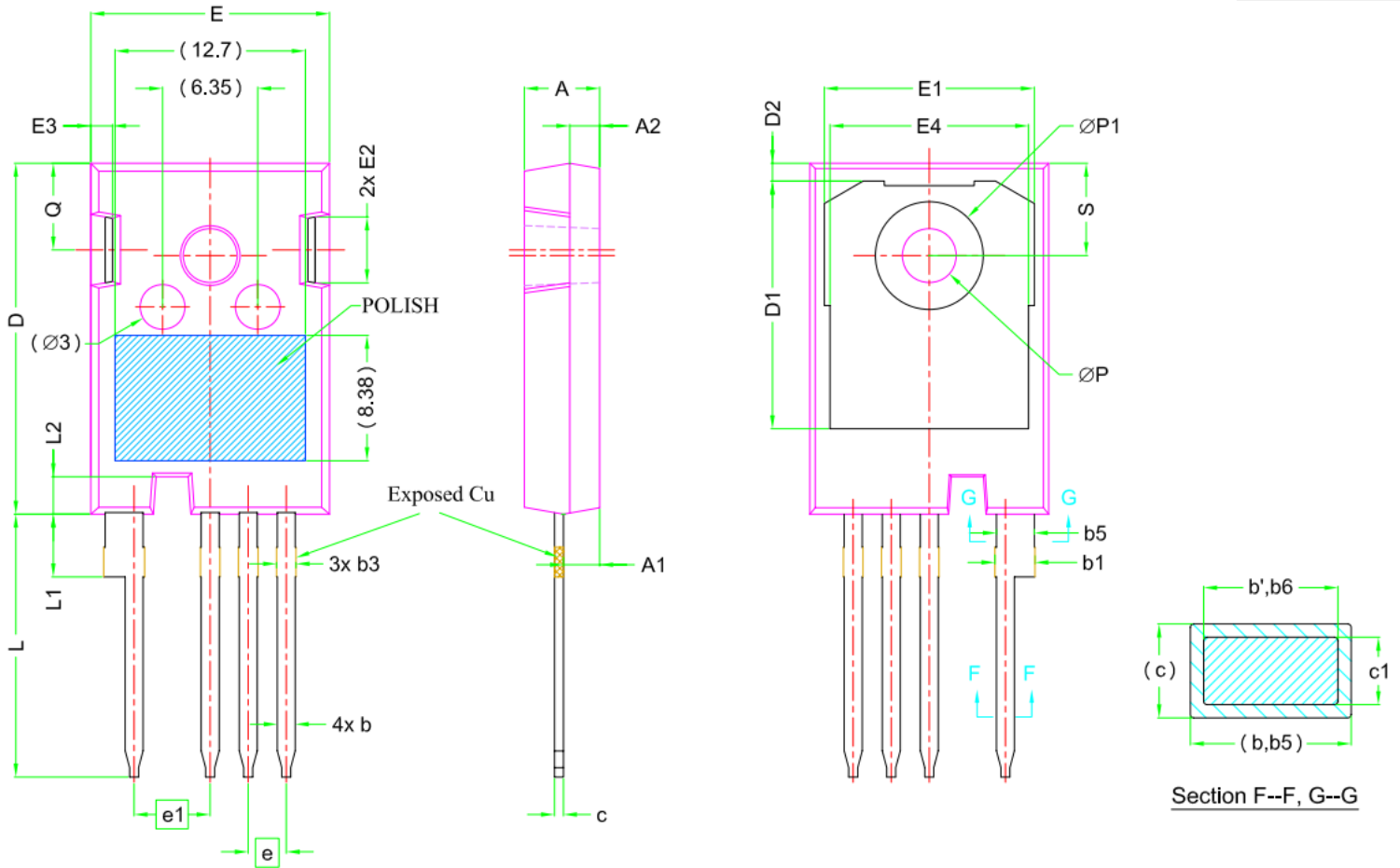

SYMBOL	DIMENSIONS		
	MIN.	NOM.	MAX.
A	4.83	5.02	5.21
A1	2.29	2.41	2.54
A2	1.91	2.00	2.16
b'	1.07	1.20	1.28
b	1.07	1.20	1.33
b1	2.39	2.67	2.94
b3	1.07	1.30	1.60
b5	2.39	2.53	2.69
b6	2.39	2.53	2.64
c	0.55	0.60	0.68
c1	0.55	0.60	0.65
D	23.30	23.45	23.60
D1	16.25	16.55	17.65
D2	0.95	1.19	1.25
E	15.75	15.94	16.13
E1	13.10	14.02	14.15
E2	3.68	4.40	5.10
E3	1.00	1.45	1.90
E4	12.38	13.26	13.43
e	2.54 BSC		
e1	5.08 BSC		
L	17.31	17.57	17.82
L1	3.97	4.19	4.37
L2	2.35	2.50	2.65
ØP	3.51	3.61	3.65
ØP1	7.19 REF.		
Q	5.49	5.79	6.00
S	6.04	6.17	6.30

Released

TO-247-3L

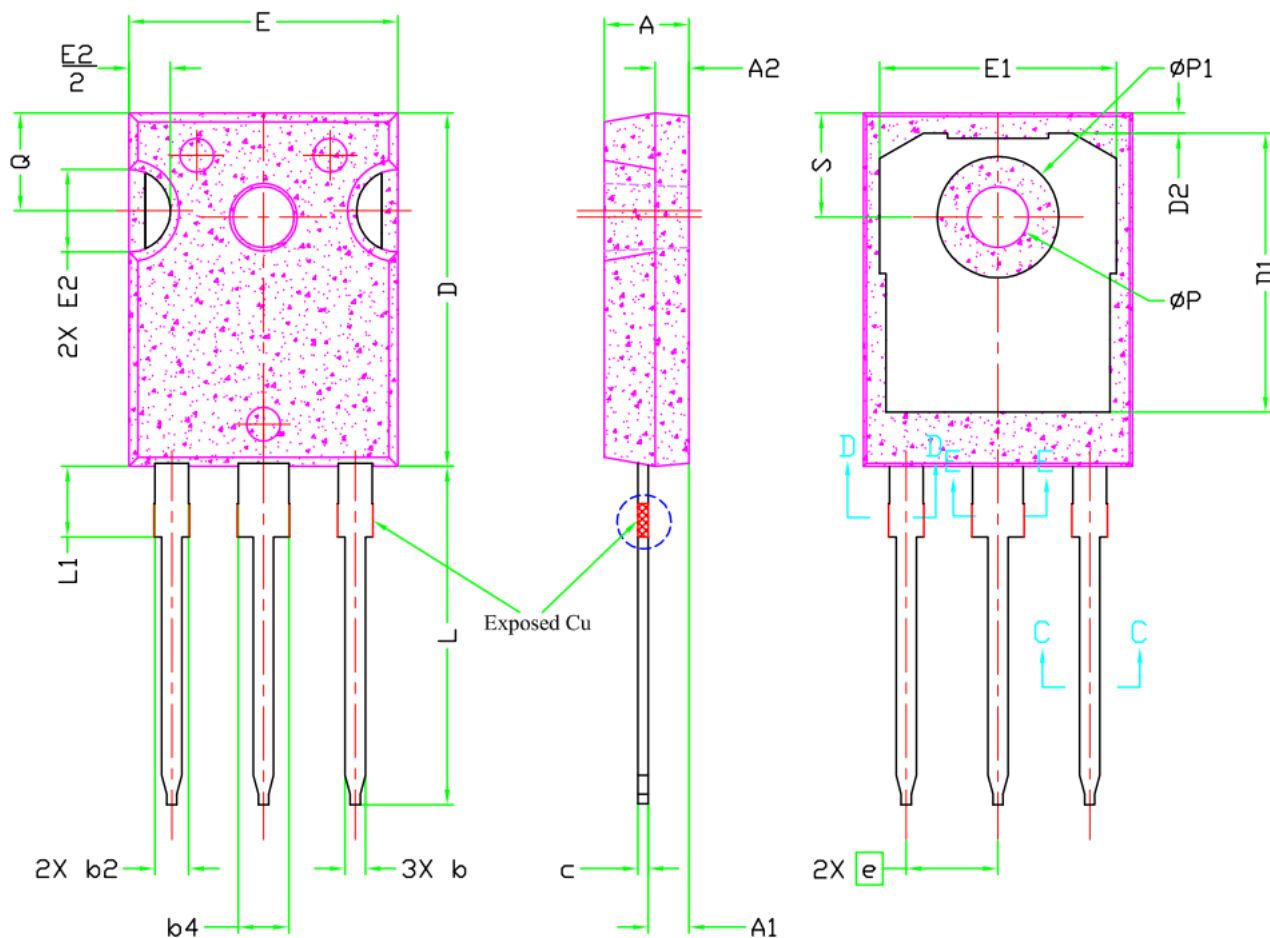

SYMBOL	DIMENSIONS			NOTES
	MIN.	NOM.	MAX.	
A	4.83	5.02	5.21	
A1	2.29	2.41	2.55	
A2	1.50	2.00	2.49	
b	1.12	1.20	1.33	
b1	1.12	1.20	1.28	
b2	1.91	2.00	2.39	6
b3	1.91	2.00	2.34	
b4	2.87	3.00	3.22	6, 8
b5	2.87	3.00	3.18	
c	0.55	0.60	0.69	6
c1	0.55	0.60	0.65	
D	20.80	20.95	21.10	4
D1	16.25	16.55	17.65	5
D2	0.51	1.19	1.35	
E	15.75	15.94	16.13	4
E1	13.46	14.02	14.16	5
E2	4.32	4.91	5.49	3
e	5.44BSC			
L	19.81	20.07	20.32	
L1	4.10	4.19	4.40	6
ØP	3.56	3.61	3.65	7
ØP1	7.19REF.			
Q	5.39	5.79	6.20	
S	6.04	6.17	6.30	

Released

**Revision History**

Revision	Date	Subjects (major changes since last revision)
1.0	2024-03-05	Preliminary version

Released

## X-ON Electronics

Largest Supplier of Electrical and Electronic Components

*Click to view similar products for [SiC MOSFETs](#) category:*

*Click to view products by [ANHI](#) manufacturer:*

Other Similar products are found below :

[NTC040N120SC1](#) [HC3M001K170J](#) [IMBG65R048M1HXTMA1](#) [IMW120R045M1](#) [SCTWA70N120G2V-4](#) [SCT040HU65G3AG](#)  
[SCTWA90N65G2V](#) [GC3M0060065K](#) [GC3M0120090D](#) [GC3M0032120D](#) [GC3M0160120D](#) [GC3M0040120K](#) [GC3M0021120D](#)  
[GC3M0065090D](#) [GC3M0032120K](#) [GC3M0065100K](#) [GC3M0075120K](#) [GC2M0040120D](#) [GC3M0280090D](#) [GC2M0025120D](#)  
[GC3M0075120D](#) [GC3M0040120D](#) [GC2M0280120D](#) [GC2M0080120K](#) [GC3M0016120D](#) [GC2M0045170D](#) [GC2M0160120K](#)  
[GC3M0021120K](#) [SP25N120CTK](#) [SP90N120CTK](#) [GC3M0080120K](#) [SP50N120CTK](#) [GC2M0160120D](#) [GC2M1000170D](#) [GC3M0120100K](#)  
[GC2M0080120D](#) [SP50N120CTF](#) [SP35N120CTF](#) [SP25N120CTF](#) [IV2Q171R0D7](#) [IV1Q06040L1](#) [IV1Q06060T3G](#) [IV1Q12160T4](#)  
[IV1B12013HA1L](#) [IV1Q12160T3](#) [IV1Q07015T4G](#) [IV1Q12750O3](#) [IV1Q06040T3](#) [IV1Q12050T4Z](#) [IV1Q12030T4G](#)