

## MOSFET Silicon N-Channel MOS

### 1. Applications

Single-ended flyback or two-transistor forward topologies.  
PC power, PD Adaptor, LCD & PDP TV and LED lighting.



### 2. Features

Low drain-source on-resistance:  $R_{DS(ON)} = 4.2\text{m}\Omega$  (typ.)  
Easy to control Gate switching  
Enhancement mode:  $V_{th} = 2.5$  to  $3.5\text{ V}$

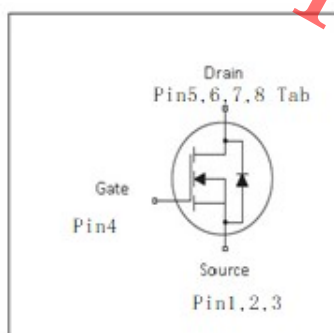
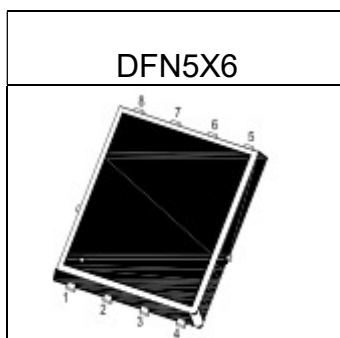
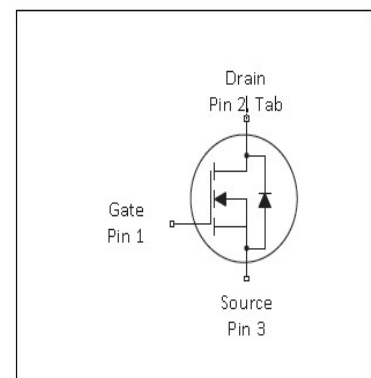
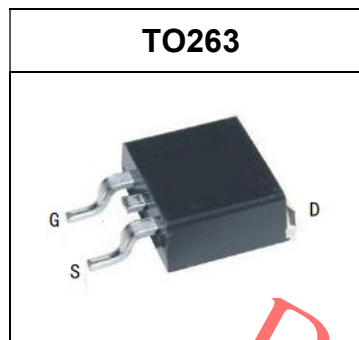

**Table 1 Key Performance Parameters**

| Parameter            | Value | Unit             |
|----------------------|-------|------------------|
| $V_{DS} @ T_{j,max}$ | 85    | V                |
| $R_{DS(on),max}$     | 5.2   | $\text{m}\Omega$ |
| $Q_{g,typ}$          | 68.4  | nC               |
| $I_{D,pulse}$        | 480   | A                |

### 3. Packaging and Internal Circuit

| Part Name  | Package | Marking    |
|------------|---------|------------|
| AUP052N085 | TO220   | AUP052N085 |
| AUB050N085 | TO263   | AUB050N085 |
| AUN045N085 | DFN5X6  | AUN045N085 |



Released

## 1 Maximum ratings

at  $T_j = 25^\circ\text{C}$ , unless otherwise specified

**Table 2 Maximum ratings**

| Parameter                              | Symbol        | Values |      |      | Unit             | Note / Test Condition  |
|--|---------------|--------|------|------|------------------|--|
|  |               | Min.   | Typ. | Max. |                  |  |
| Continuous drain current <sup>1)</sup> | $I_D$         |        | -    | 119  | A                | $T_C=25^\circ\text{C}$   |
| Continuous drain current               | $I_D$         |        | -    | 89   | A                | $T_C=100^\circ\text{C}$  |
| Pulsed drain current <sup>2)</sup>     | $I_{D,pulse}$ | -      | -    | 480  | A                | $T_C=25^\circ\text{C}$   |
| Avalanche energy, single pulse         | $E_{AS}$      | -      | -    | 420  | mJ               | $T_C=25^\circ\text{C}$ , $V_{DD}=50\text{V}$ , $I=41\text{A}$ ,<br>$L=0.5\text{mH}$ , $R_G=25\Omega$ |
| Avalanche current, single pulse        | $I_{AR}$      | -      | -    | 41   | A                | $T_C=25^\circ\text{C}$ , $V_{DD}=50\text{V}$ , $L=0.5\text{mH}$ ,<br>$R_G=25\Omega$                  |
| Gate source voltage (static)           | $V_{GS}$      | -20    | -    | 20   | V                | static;  |
| Power dissipation                      | $P_{tot}$     | -      | -    | 183  | W                | $T_C=25^\circ\text{C}$   |
| Storage temperature                    | $T_{stg}$     | -55    | -    | 150  | $^\circ\text{C}$ |  |
| Operating junction temperature         | $T_j$         | -55    | -    | 150  | $^\circ\text{C}$ |  |
| Transconductance                       | GFS           | -      | 76   | -    | S                | $V_{DS}=5\text{V}$ $I_{DS}=50\text{A}$   |

<sup>1)</sup>Limited by  $T_{j,max}$ . Maximum Duty Cycle  $D = 0.50$

<sup>2)</sup>Pulse width  $t_p$  limited by  $T_{j,max}$

<sup>3)</sup>Identical low side and high side switch with identical  $R_G$

Released

## 2 Thermal characteristics

### Thermal characteristics (TO220)

| Parameter                              | Symbol     | Values |      |      | Unit | Note / Test Condition            |
|--|------------|--------|------|------|------|----------------------------------|
|  |            | Min.   | Typ. | Max. |      |                                  |
| Thermal resistance, junction - case    | $R_{thJC}$ | -      | -    | 0.9  | °C/W | -                                |
| Thermal resistance, junction - ambient | $R_{thJA}$ | -      | -    | 62   | °C/W | device on PCB, minimal footprint |

### Thermal characteristics (TO263)

| Parameter                              | Symbol     | Values |      |      | Unit | Note / Test Condition            |
|--|------------|--------|------|------|------|----------------------------------|
|  |            | Min.   | Typ. | Max. |      |                                  |
| Thermal resistance, junction - case    | $R_{thJC}$ | -      | -    | 1.0  | °C/W | -                                |
| Thermal resistance, junction - ambient | $R_{thJA}$ | -      | -    | 60   | °C/W | device on PCB, minimal footprint |

### Thermal characteristics (DFN5X6)

| Parameter                              | Symbol     | Values |      |      | Unit | Note / Test Condition            |
|--|------------|--------|------|------|------|----------------------------------|
|  |            | Min.   | Typ. | Max. |      |                                  |
| Thermal resistance, junction - case    | $R_{thJC}$ | -      | -    | 1.3  | °C/W | -                                |
| Thermal resistance, junction - ambient | $R_{thJA}$ | -      | -    | 50   | °C/W | device on PCB, minimal footprint |

### 3 Electrical characteristics

at  $T_j=25^{\circ}\text{C}$ , unless otherwise specified

**Table 4 Static characteristics**

| Parameter                        | Symbol        | Values |      |           | Unit       | Note / Test Condition  |
|----------------------------------|---------------|--------|------|-----------|------------|--|
|                                  |               | Min.   | Typ. | Max.      |            |  |
| Drain-source breakdown voltage   | $V_{(BR)DSS}$ | 85     | -    | -         | V          | $V_{GS}=0V, I_D=250\mu A$                                    |
| Gate threshold voltage           | $V_{(GS)th}$  | 2.5    |      | 3.5       | V          | $V_{DS}=V_{GS}, I_D=250\mu A$                                |
| Zero gate voltage drain current  | $I_{DSS}$     | -      | -    | 1         | $\mu A$    | $V_{DS}=85V, V_{GS}=0V, T_j=25^{\circ}\text{C}$              |
| Gate-source leakage current      | $I_{GSS}$     | -      | -    | $\pm 100$ | nA         | $V_{GS}=\pm 20V, V_{DS}=0V$                                  |
| Drain-source on-state resistance | $R_{DS(on)}$  | -      | 4.2  | 5.2       | m $\Omega$ | $V_{GS}=10V, I_D=20A, T_j=25^{\circ}\text{C}(\text{TO220})$  |
| Drain-source on-state resistance | $R_{DS(on)}$  | -      | 3.9  | 5.0       | m $\Omega$ | $V_{GS}=10V, I_D=20A, T_j=25^{\circ}\text{C}(\text{TO263})$  |
| Drain-source on-state resistance | $R_{DS(on)}$  | -      | 3.7  | 4.5       | m $\Omega$ | $V_{GS}=10V, I_D=20A, T_j=25^{\circ}\text{C}(\text{DFN5X6})$ |
| Gate resistance (Intrinsic)      | $R_G$         | -      | 1.8  | -         | $\Omega$   | $f=1\text{MHz}$ , open drain                                 |

**Table 5 Dynamic characteristics**

| Parameter                    | Symbol       | Values |      |      | Unit | Note / Test Condition                            |
|------------------------------|--------------|--------|------|------|------|--|
|                              |              | Min.   | Typ. | Max. |      |  |
| Input capacitance            | $C_{iss}$    | -      | 4587 | -    | pF   | $V_{GS}=0V, V_{DS}=40V, f=1\text{MHz}$           |
| Output capacitance           | $C_{oss}$    | -      | 824  | -    | pF   | $V_{GS}=0V, V_{DS}=40V, f=1\text{MHz}$           |
| Reverse transfer capacitance | $C_{rss}$    | -      | 5.5  | -    | pF   | $V_{GS}=0V, V_{DS}=40V, f=0.7\text{MHz}$         |
| Turn-on delay time           | $t_{d(on)}$  | -      | 22   | -    | ns   | $V_{DD}=40V, V_{GS}=10V, I_D=56A, R_G=1.6\Omega$ |
| Rise time                    | $t_r$        | -      | 33.6 | -    | ns   | $V_{DD}=40V, V_{GS}=10V, I_D=56A, R_G=1.6\Omega$ |
| Turn-off delay time          | $t_{d(off)}$ | -      | 34.6 | -    | ns   | $V_{DD}=40V, V_{GS}=10V, I_D=56A, R_G=1.6\Omega$ |
| Fall time                    | $t_f$        | -      | 17.4 | -    | ns   | $V_{DD}=40V, V_{GS}=10V, I_D=56A, R_G=1.6\Omega$ |

**Table 6 Gate charge characteristics**

| Parameter             | Symbol        | Values |      |      | Unit | Note / Test Condition                           |
|-----------------------|---------------|--------|------|------|------|---|
|                       |               | Min.   | Typ. | Max. |      |   |
| Gate to source charge | $Q_{gs}$      | -      | 24.6 | -    | nC   | $V_{DD}=40V, I_D=56A, V_{GS}=0 \text{ to } 10V$ |
| Gate to drain charge  | $Q_{gd}$      | -      | 15.5 | -    | nC   | $V_{DD}=40V, I_D=56A, V_{GS}=0 \text{ to } 10V$ |
| Gate charge total     | $Q_g$         | -      | 68.4 | -    | nC   | $V_{DD}=40V, I_D=56A, V_{GS}=0 \text{ to } 10V$ |
| Gate plateau voltage  | $V_{plateau}$ | -      | 5.2  | -    | V    | $V_{DD}=40V, I_D=56A, V_{GS}=0 \text{ to } 10V$ |

Released

**Table 7 Reverse diode characteristics**

| Parameter                     | Symbol    | Values |      |      | Unit | Note / Test Condition                  |
|-------------------------------|-----------|--------|------|------|------|--|
|                               |           | Min.   | Typ. | Max. |      |  |
| Diode forward voltage         | $V_{SD}$  | -      | 0.7  | -    | V    | $V_{GS}=0V, I_F=1A, T_j=25^{\circ}C$   |
| Reverse recovery time         | $t_{rr}$  | -      | 44   | -    | ns   | $V_R=40V, I_F=56A, di_F/dt=100A/\mu s$ |
| Reverse recovery charge       | $Q_{rr}$  | -      | 42   | -    | nC   | $V_R=40V, I_F=56A, di_F/dt=100A/\mu s$ |
| Peak reverse recovery current | $I_{rrm}$ | -      | 1.9  | -    | A    | $V_R=40V, I_F=56A, di_F/dt=100A/\mu s$ |

Released

### 4. Electrical characteristics diagram

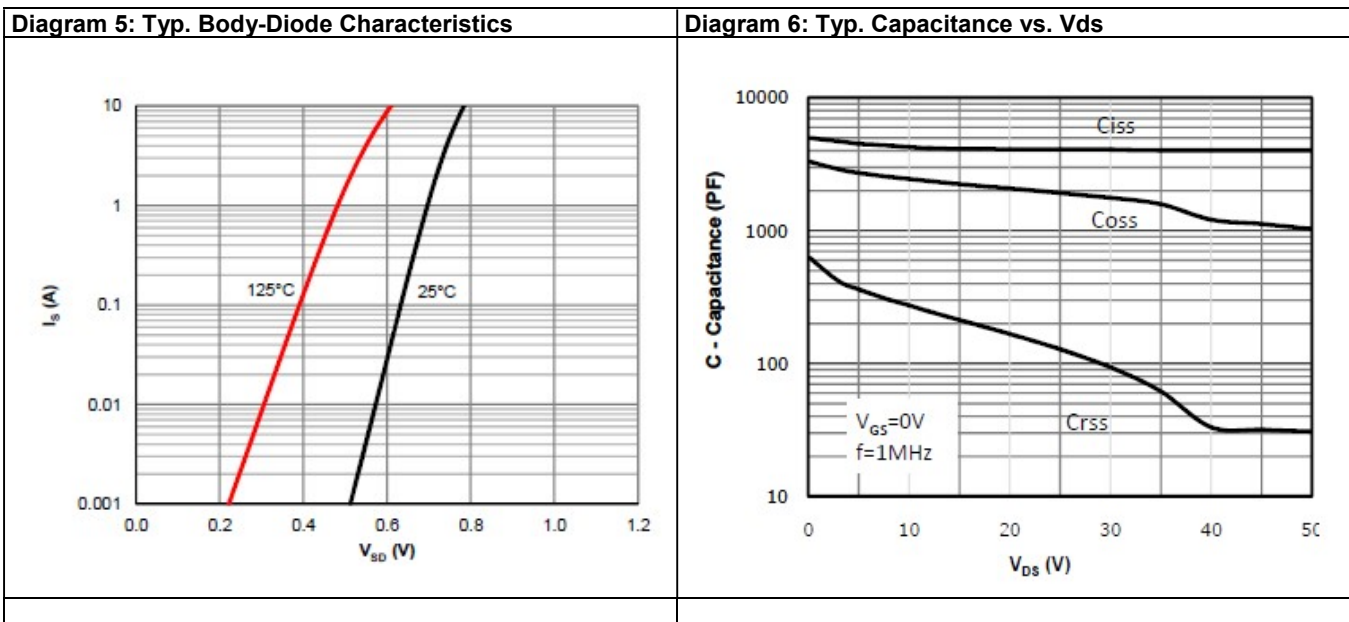
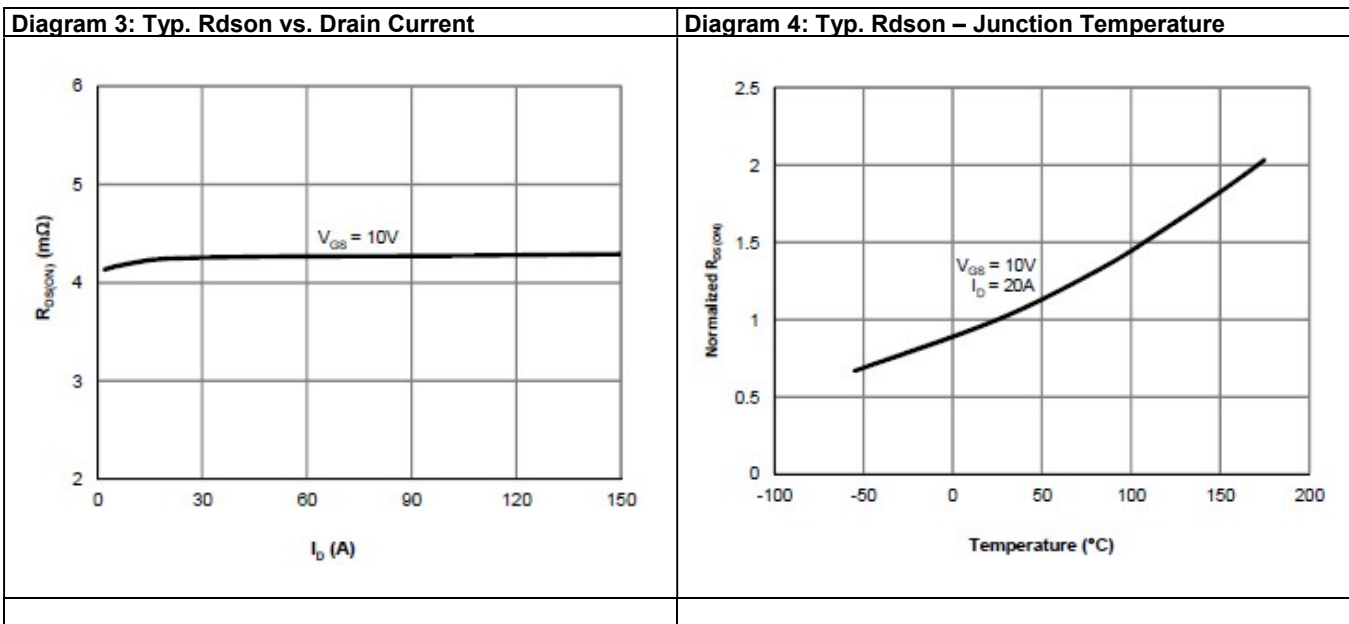
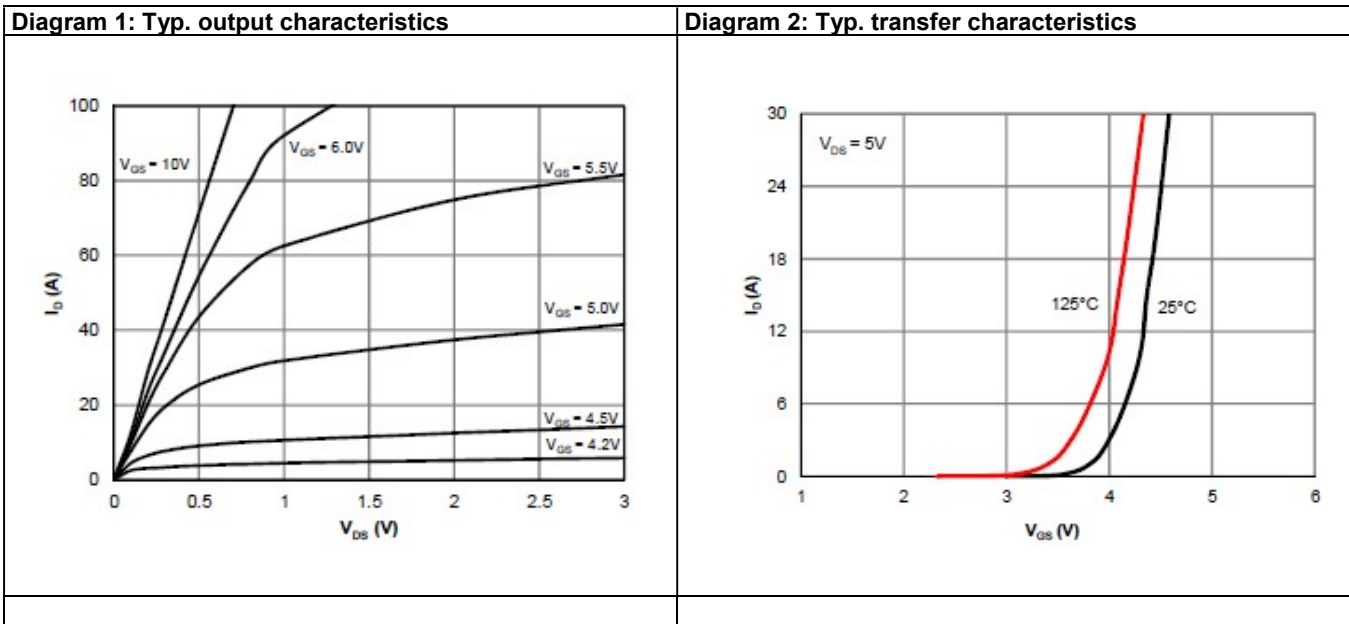

Diagram 7: Typ. Power Dissipation

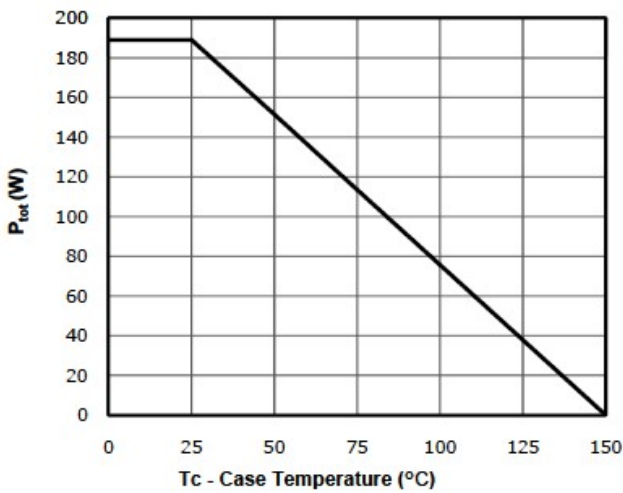

Diagram 8: Typ. Drain Current De-rating

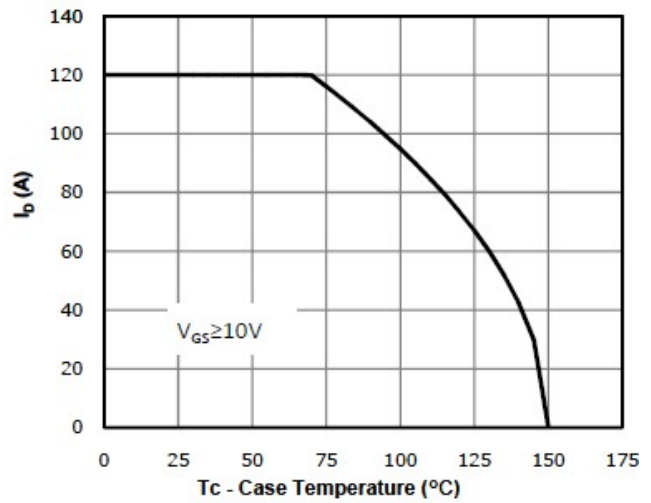

Diagram 9: Typ. Gate charge

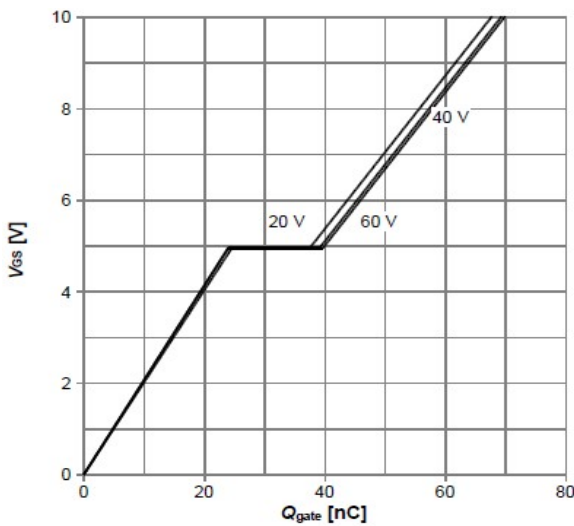

Diagram 10: Typ. Rds(on) vs Gate Voltage

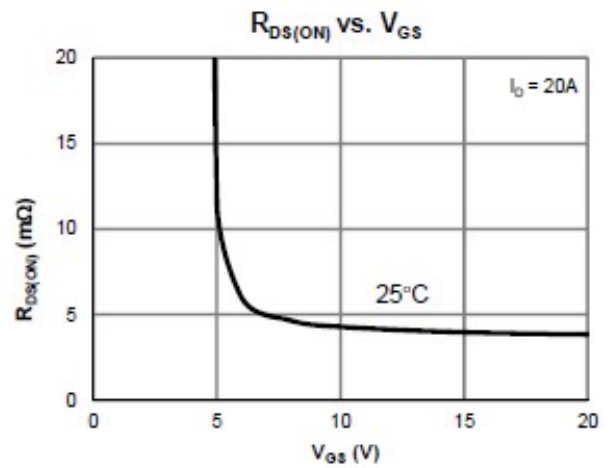

Diagram 11: Typ. Maximum Safe Operating Area

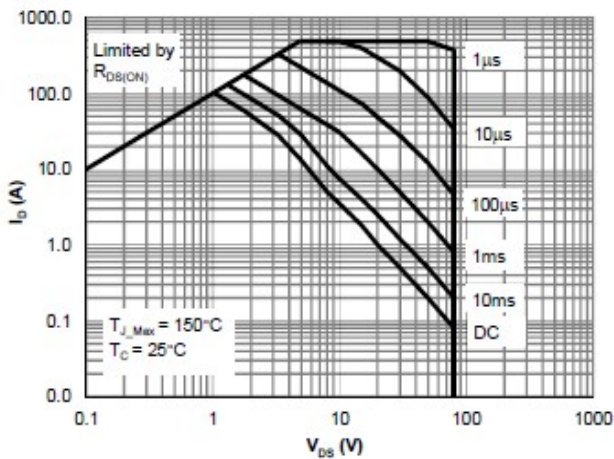

Diagram 12: Single Pulse Power Rating, Junction-to-Case

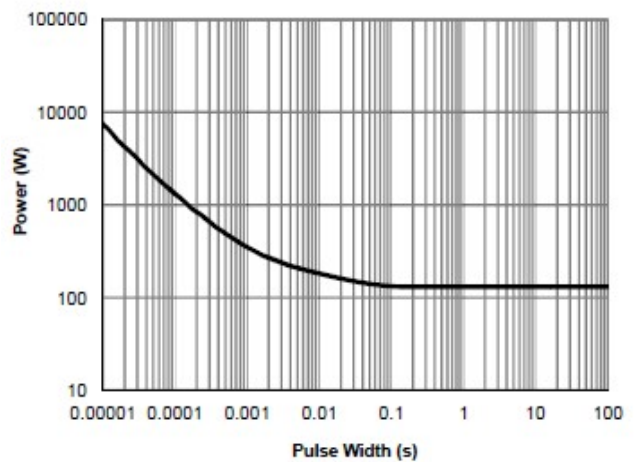
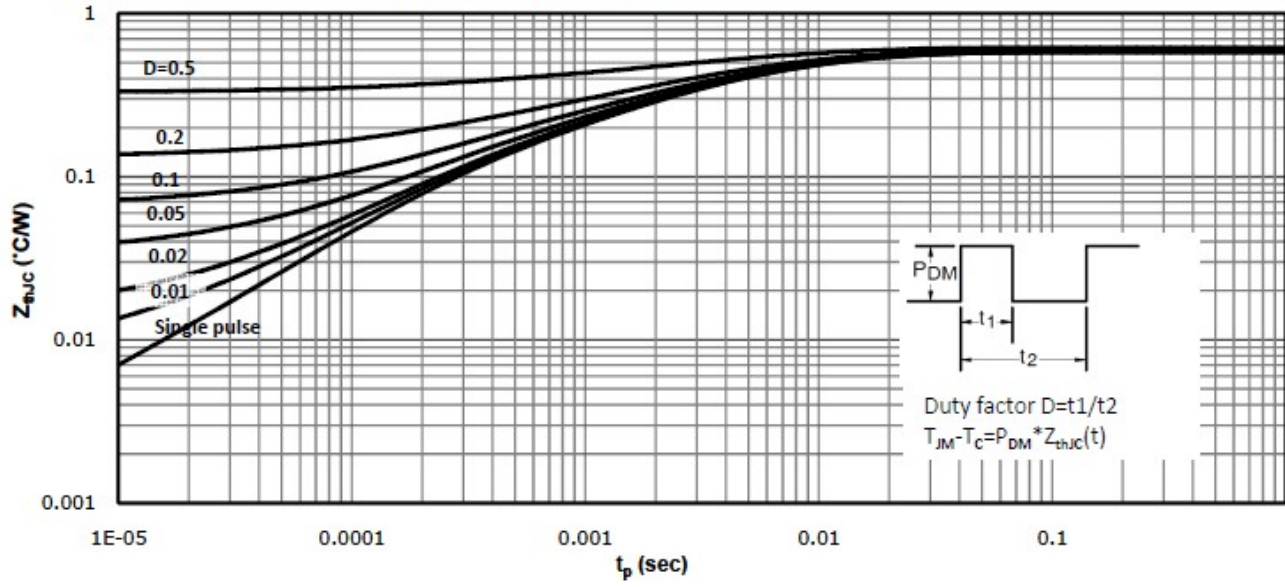

Fig 13 : Max. Transient Thermal Impedance





## 5. Test Circuits

**Table 8 Diode characteristics**

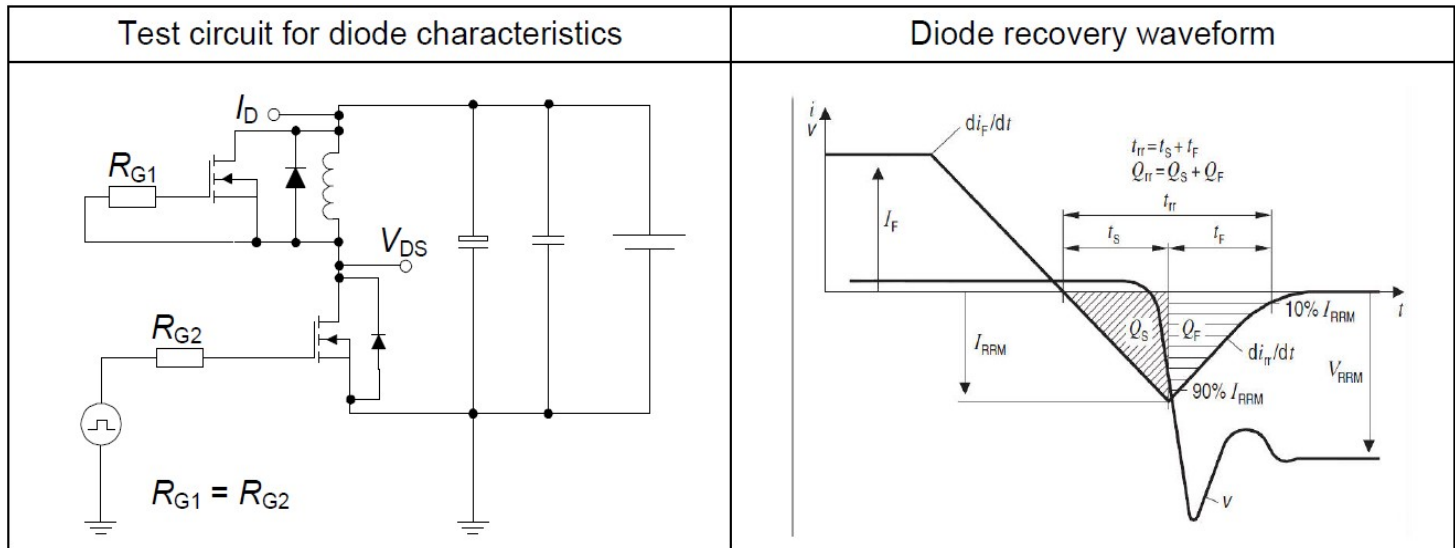

**Table 9 Switching times**

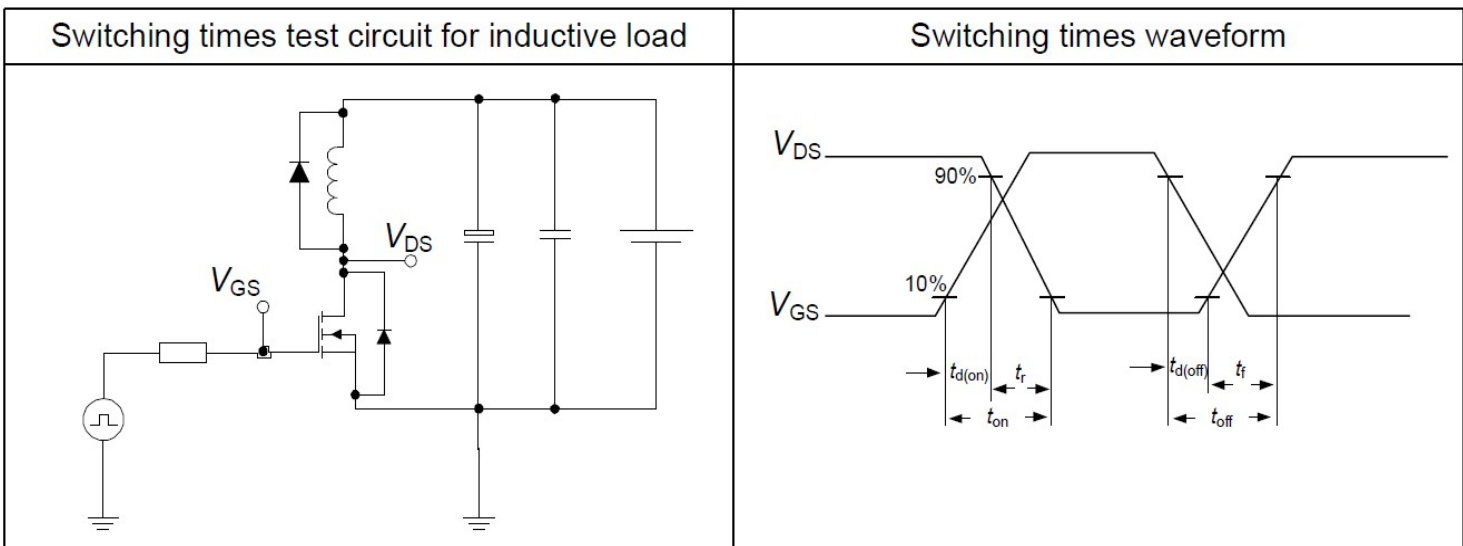

**Table 10 Unclamped inductive load**

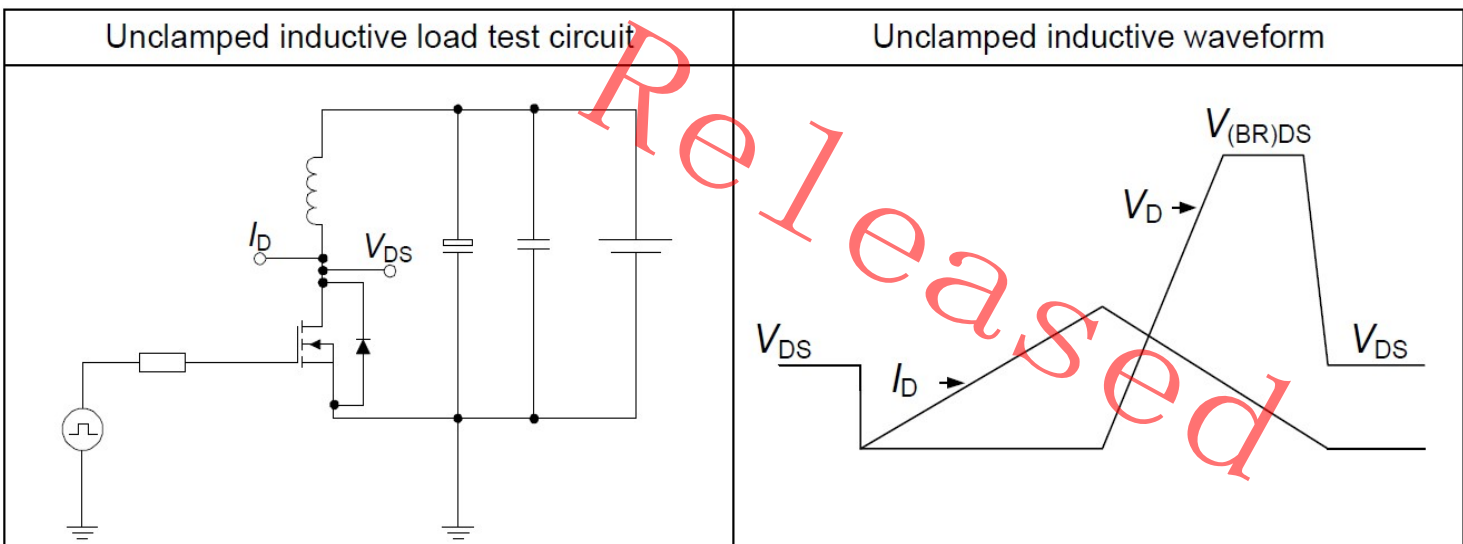

### 6 Package Outlines

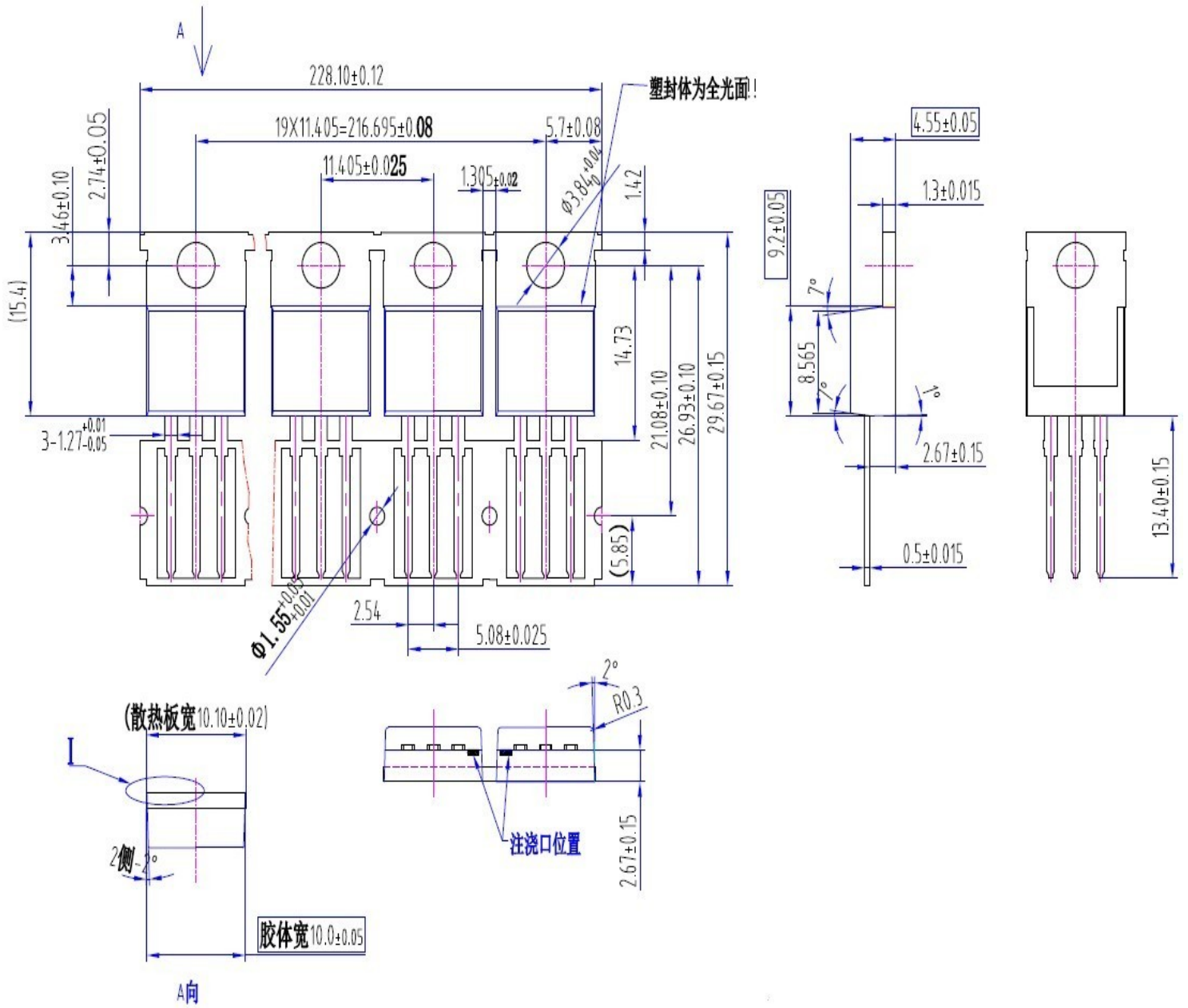

Outline PG-TO220

Outline PG-T0263 (JJW)

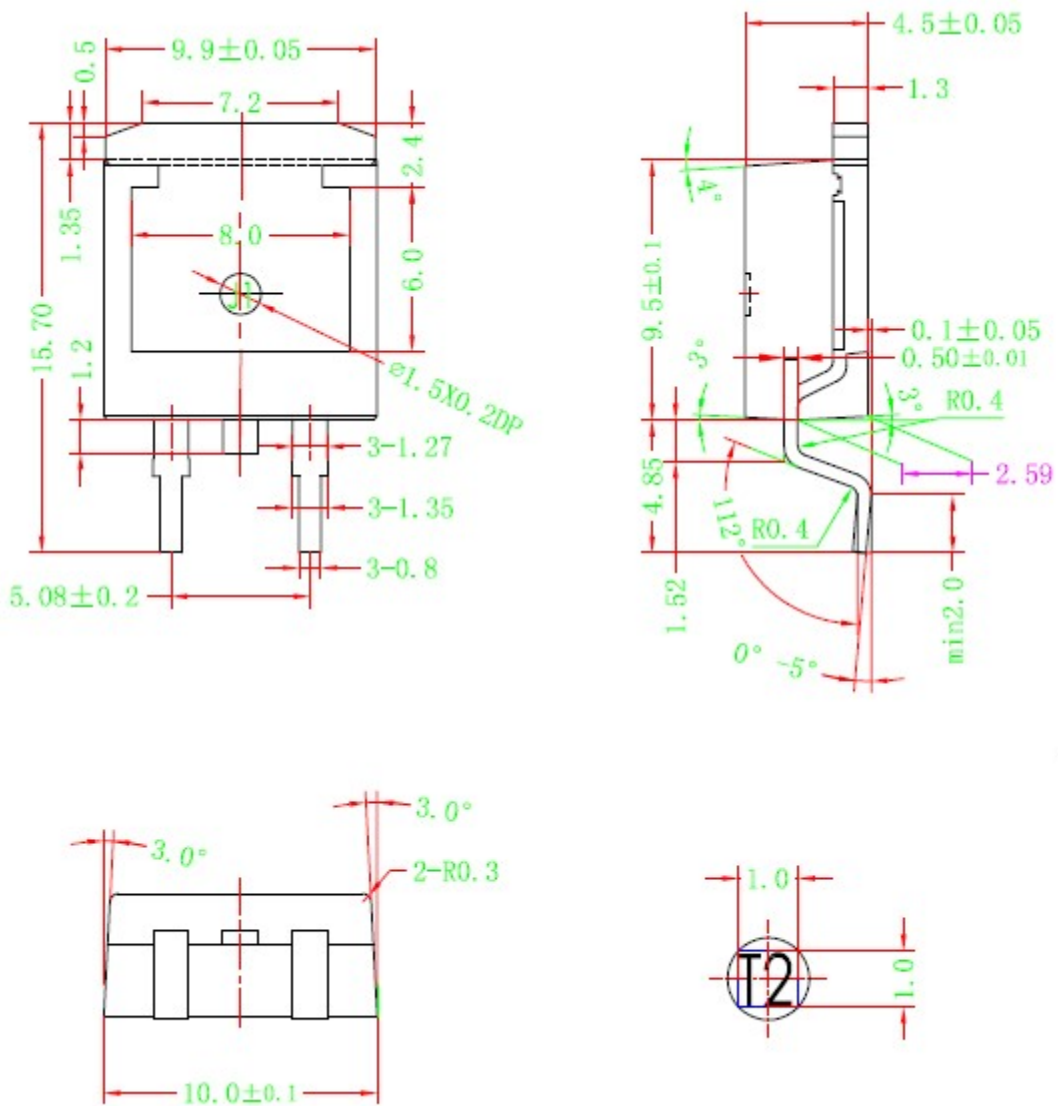

Released

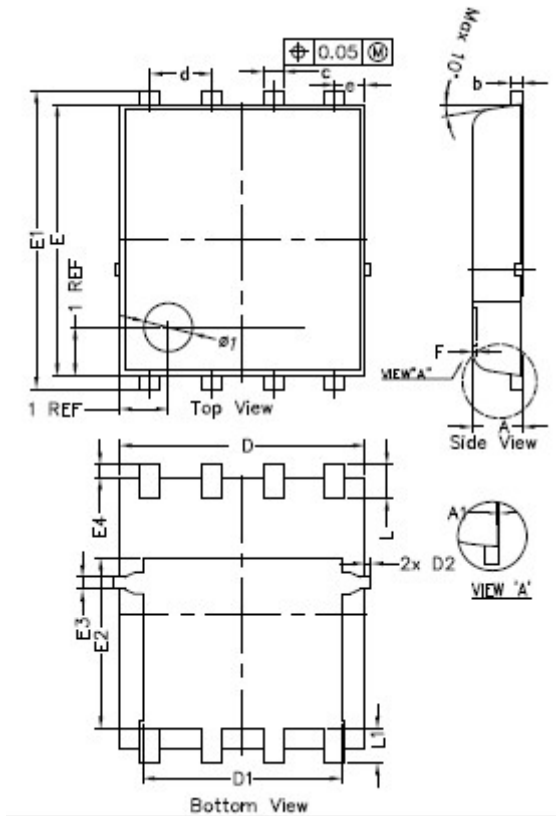

| SYMBOLS | DIMENSION IN MM |       |       | DIMENSION IN INCHES |       |       |
|---------|-----------------|-------|-------|---------------------|-------|-------|
|         | MIN             | NOM   | MAX   | MIN                 | NOM   | MAX   |
| * A     | 0.900           | 1.000 | 1.100 | 0.035               | 0.039 | 0.043 |
| A1      | 0.000           | ---   | 0.050 | 0.000               | ---   | 0.002 |
| b       | 0.246           | 0.254 | 0.312 | 0.010               | 0.010 | 0.012 |
| * c     | 0.310           | 0.410 | 0.510 | 0.012               | 0.016 | 0.020 |
| d       | 1.27 BSC        |       |       | 0.050 BSC           |       |       |
| * D     | 4.950           | 5.050 | 5.150 | 0.195               | 0.199 | 0.203 |
| D1      | 4.000           | 4.100 | 4.200 | 0.157               | 0.161 | 0.165 |
| * D2    | ---             | ---   | 0.125 | ---                 | ---   | 0.005 |
| e       | 0.62 BSC        |       |       | 0.024 BSC           |       |       |
| * E     | 5.500           | 5.600 | 5.700 | 0.217               | 0.220 | 0.224 |
| * E1    | 6.050           | 6.150 | 6.250 | 0.238               | 0.242 | 0.246 |
| E2      | 3.425           | 3.525 | 3.625 | 0.135               | 0.139 | 0.143 |
| E3      | 0.150           | 0.250 | 0.350 | 0.006               | 0.010 | 0.014 |
| * E4    | 0.175           | 0.275 | 0.375 | 0.007               | 0.011 | 0.015 |
| F       | -               | -     | 0.100 | -                   | -     | 0.004 |
| * L     | 0.500           | 0.600 | 0.700 | 0.02                | 0.02  | 0.03  |
| L1      | 0.600           | 0.700 | 0.800 | 0.02                | 0.03  | 0.03  |

NOTE:  
 1. PACKAGE BODY SIZE EXCLUDE MOLD FLASH AND GATE BURR.  
 MOLD FLASH AT THE NON-LEAD SIDES SHOULD BE LESS THAN 5 MIL EACH SIDE.  
 2. CONTROLLING DIMENSION IS MILLIMETER, INCH FOR REFERENCE ONLY.

Outline PG-DFN5X6 (JJW)

Released

## Revision History

| Revision | Date       | Subjects (major changes since last revision) |
|----------|------------|--|
| 1.0      | 2021-11-10 | Preliminary version                          |
| 1.1      | 2021-11-16 | Updated Qrr                                  |
| 1.2      | 2021-11-17 | Add gfs data                                 |
| 1.3      | 2021-12-28 | Added Electrical characteristics diagram     |
| 1.4      | 2022-1-10  | Added DFN5X6 package                         |

Released

## X-ON Electronics

Largest Supplier of Electrical and Electronic Components

*Click to view similar products for [MOSFET](#) category:*

*Click to view products by [ANHI](#) manufacturer:*

Other Similar products are found below :

[IRFD120](#) [IRFY240C](#) [JANTX2N5237](#) [2SK2267\(Q\)](#) [BUK455-60A/B](#) [MIC4420CM-TR](#) [VN1206L](#) [NDP4060](#) [SI4482DY](#)  
[IPS70R2K0CEAKMA1](#) [SQD23N06-31L-GE3](#) [TK16J60W,S1VQ\(O](#) [2SK2614\(TE16L1,Q\)](#) [DMN1017UCP3-7](#) [EFC2J004NUZTDG](#)  
[DMN1053UCP4-7](#) [SQJ469EP-T1-GE3](#) [NTE2384](#) [DMC2700UDMQ-7](#) [DMN2080UCB4-7](#) [DMN61D9UWQ-13](#) [US6M2GTR](#)  
[DMN31D5UDJ-7](#) [DMP22D4UFO-7B](#) [DMN1006UCA6-7](#) [DMN16M9UCA6-7](#) [STF5N65M6](#) [IRF40H233XTMA1](#) [STU5N65M6](#)  
[DMN6022SSD-13](#) [DMN13M9UCA6-7](#) [DMTH10H4M6SPS-13](#) [DMN2990UFB-7B](#) [IPB80P04P405ATMA2](#) [2N7002W-G](#) [MCAC30N06Y-](#)  
[TP](#) [MCQ7328-TP](#) [NTMC083NP10M5L](#) [NVMFS2D3P04M8LT1G](#) [BXP7N65D](#) [BXP4N65F](#) [AOL1454G](#) [WMJ80N60C4](#) [BXP2N20L](#)  
[BXP2N65D](#) [BXT1150N10J](#) [BXT1700P06M](#) [TSM60NB380CP](#) [ROG](#) [RQ7L055BGTCR](#) [DMNH15H110SK3-13](#)