

## MOSFET Silicon N-Channel MOS



### 1. Applications

Synchronous rectification in SMPS,  
Hard switching and High speed circuit  
DC/DC in telecoms and industrial

### 2. Features

Low drain-source on-resistance:  $R_{DS(ON)} = 2.9m\Omega$  (typ.)  
High speed power switching  
Enhanced body diode  $dv/dt$  capability  
Enhanced avalanche ruggedness

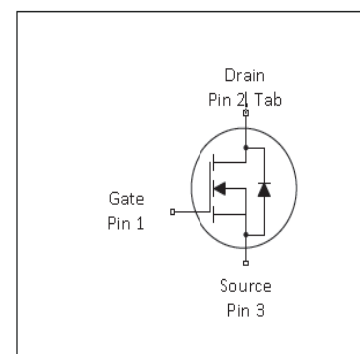

**Table 1 Key Performance Parameters**

Parameter	Value	Unit
$V_{DS} @ T_{j,max}$	85	V
$R_{DS(on),max}$	3.3	m $\Omega$
$Q_{g,typ}$	109	nC
$I_{D,pulse}$	640	A

### 3. Packaging and Internal Circuit

Part Name	Package	Marking
AUB033N08BG	TO263	AUB033N08BG
AUP033N08BG	TO220	AUP033N08BG
AUW033N08BG	TO247	AUW033N08BG



## 1 Maximum ratings

at  $T_j = 25^\circ\text{C}$ , unless otherwise specified

**Table 2 Maximum ratings**

Parameter	Symbol	Values			Unit	Note / Test Condition
		Min.	Typ.	Max.		
Continuous drain current <sup>1)</sup>	$I_D$		-	160 115	A	$T_C = 25^\circ\text{C}$ $T_C = 100^\circ\text{C}$
Pulsed drain current <sup>2)</sup>	$I_{D,pulse}$	-		640	A	$T_C = 25^\circ\text{C}$
Avalanche energy, single pulse	$E_{AS}$	-	-	884	mJ	
Gate source voltage (static)	$V_{GS}$	-20	-	20	V	static;
Power dissipation(TO220)	$P_{tot}$	-	-	370	W	$T_C = 25^\circ\text{C}$
Power dissipation(TO263)	$P_{tot}$	-	-	179	W	$T_C = 25^\circ\text{C}$
Power dissipation(TO247)	$P_{tot}$	-	-	340	W	$T_C = 25^\circ\text{C}$
Storage temperature	$T_{stg}$	-55	-	175	$^\circ\text{C}$	
Operating junction temperature	$T_j$	-55	-	175	$^\circ\text{C}$	

<sup>1)</sup> Limited by  $T_{j,max}$ . Maximum Duty Cycle  $D = 0.50$

<sup>2)</sup> Pulse width  $t_p$  limited by  $T_{j,max}$

<sup>3)</sup> Identical low side and high side switch with identical  $R_G$

## 2 Thermal characteristics

**Table 3 Thermal characteristics(TO220)**

Parameter	Symbol	Values			Unit	Note / Test Condition
		Min.	Typ.	Max.		
Thermal resistance, junction - case	$R_{thJC}$	-	-	0.42	°C/W	-
Thermal resistance, junction - ambient	$R_{thJA}$	-	-	62	°C/W	device on PCB, minimal footprint

### Thermal characteristics (TO263)

Parameter	Symbol	Values			Unit	Note / Test Condition
		Min.	Typ.	Max.		
Thermal resistance, junction - case	$R_{thJC}$	-	-	0.7	°C/W	-
Thermal resistance, junction - ambient	$R_{thJA}$	-	-	62	°C/W	device on PCB, minimal footprint

### Thermal characteristics (TO247)

Parameter	Symbol	Values			Unit	Note / Test Condition
		Min.	Typ.	Max.		
Thermal resistance, junction - case	$R_{thJC}$	-	-	0.44	°C/W	-
Thermal resistance, junction - ambient	$R_{thJA}$	-	-	40	°C/W	device on PCB, minimal footprint

### 3 Electrical characteristics

at  $T_j=25^\circ\text{C}$ , unless otherwise specified

**Table 4 Static characteristics**

Parameter	Symbol	Values			Unit	Note / Test Condition
		Min.	Typ.	Max.		
Drain-source breakdown voltage	$V_{(BR)DSS}$	85	-	-	V	$V_{GS}=0V, I_D=10mA$
Gate threshold voltage	$V_{(GS)th}$	2.5		3.5	V	$V_{DS}=V_{GS}, I_D=250\mu A$
Zero gate voltage drain current	$I_{DSS}$	-	-	1000	nA	$V_{DS}=80V, V_{GS}=0V, T_j=25^\circ\text{C}$
Gate-source leakage current	$I_{GSS}$	-	-	100	nA	$V_{GS}=20V, V_{DS}=0V$
Drain-source on-state resistance	$R_{DS(on)}$	-	2.9	3.3	m $\Omega$	$V_{GS}=10V, I_D=20A, T_j=25^\circ\text{C}$
Gate resistance (Intrinsic)	$R_G$	-	0.7	-	$\Omega$	$f=1MHz, \text{open drain}$

**Table 5 Dynamic characteristics**

Parameter	Symbol	Values			Unit	Note / Test Condition
		Min.	Typ.	Max.		
Input capacitance	$C_{iss}$	-	7463	-	pF	$V_{DS}=40V, V_{GS}=0V$ $f=1MHz$
Output capacitance	$C_{oss}$	-	1292	-	pF	$V_{DS}=40V, V_{GS}=0V$ $f=1MHz$
Reverse transfer capacitance	$C_{rss}$	-	43.4	-	pF	$V_{DS}=40V, V_{GS}=0V$ $f=1MHz$
Turn-on delay time	$t_{d(on)}$	-	24	-	ns	$V_{DD}=40V, V_{GS}=10V, R_G=10\Omega$ $I_D=20A$
Rise time	$t_r$	-	53	-	ns	$V_{DD}=40V, V_{GS}=10V, R_G=10\Omega$ $I_D=20A$
Turn-off delay time	$t_{d(off)}$	-	107	-	ns	$V_{DD}=40V, V_{GS}=10V, R_G=10\Omega$ $I_D=20A$
Fall time	$t_f$	-	66	-	ns	$V_{DD}=40V, V_{GS}=10V, R_G=10\Omega$ $I_D=20A$

**Table 6 Gate charge characteristics**

Parameter	Symbol	Values			Unit	Note / Test Condition
		Min.	Typ.	Max.		
Gate to source charge	$Q_{gs}$	-	27.5	-	nC	$V_{DS}=40V, V_{GS}=0 \text{ to } 10V$ $I_D=20A$
Gate to drain charge	$Q_{gd}$	-	26.4	-	nC	$V_{DS}=40V, V_{GS}=0 \text{ to } 10V$ $I_D=20A$
Gate charge total	$Q_g$	-	109	-	nC	$V_{DS}=40V, V_{GS}=0 \text{ to } 10V$ $I_D=20A$

**Table 7 Reverse diode characteristics**

Parameter	Symbol	Values			Unit	Note / Test Condition
		Min.	Typ.	Max.		
Diode forward voltage	$V_{SD}$	-	0.67	-	V	$V_{GS}=0V, I_F=1A, T_J=25^{\circ}C$
Reverse recovery time	$t_{rr}$	-	52	-	ns	$V_R=40V, I_F=20A, diF/dt=200A/us$
Reverse recovery charge	$Q_{rr}$	-	137	-	uC	$V_R=40V, I_F=20A, diF/dt=200A/us$
Peak reverse recovery current	$I_{rrm}$	-	-3.7	-	A	$V_R=40V, I_F=20A, diF/dt=200A/us$

Electrical characteristics diagram

Diagram 1: Drain-Source on-state resistance

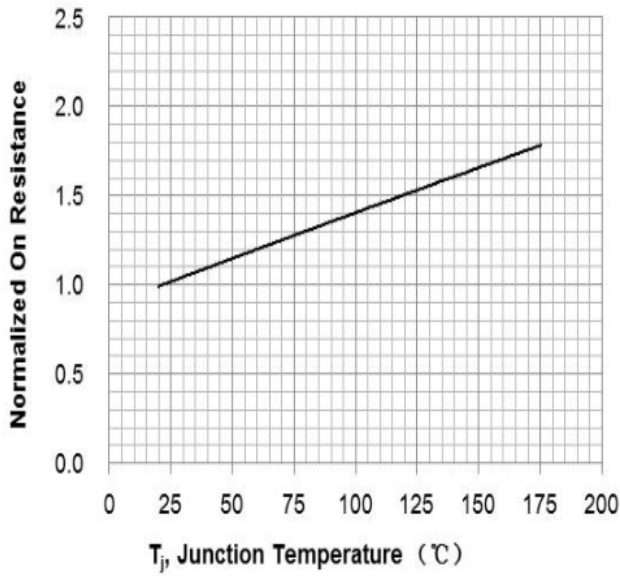

$R_{DS(on)}=f(T_j)$ ;  $I_D=20$  A;  $V_{GS}=10$  V

Diagram 2: Typ. transfer characteristics

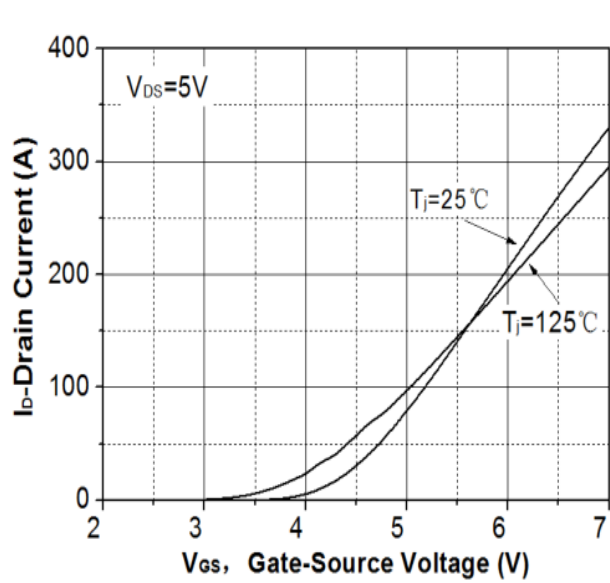

$I_D=f(V_{GS})$ ;  $V_{DS}=5$  V; parameter:  $T_j$

Diagram 3: Drain-Source on-state resistance

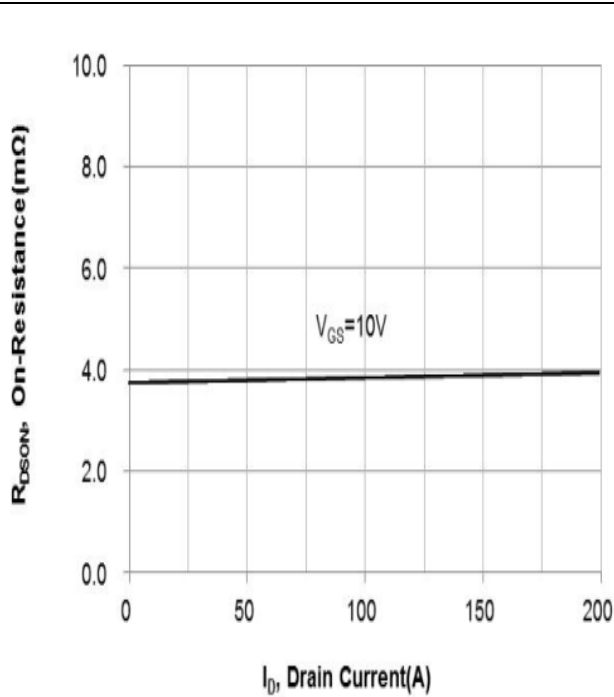

$R_{DS(on)}=f(I_D)$ ; parameter:  $V_{GS}$

Diagram 4: Typ. Capacitances

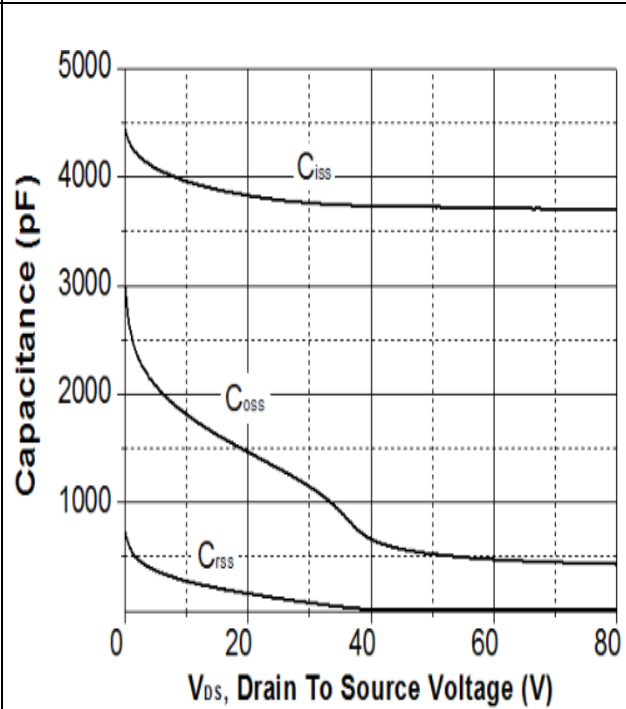

$C=f(V_{DS})$ ;  $V_{GS}=0$  V;  $f=1$  MHz

### 4 Package Outlines

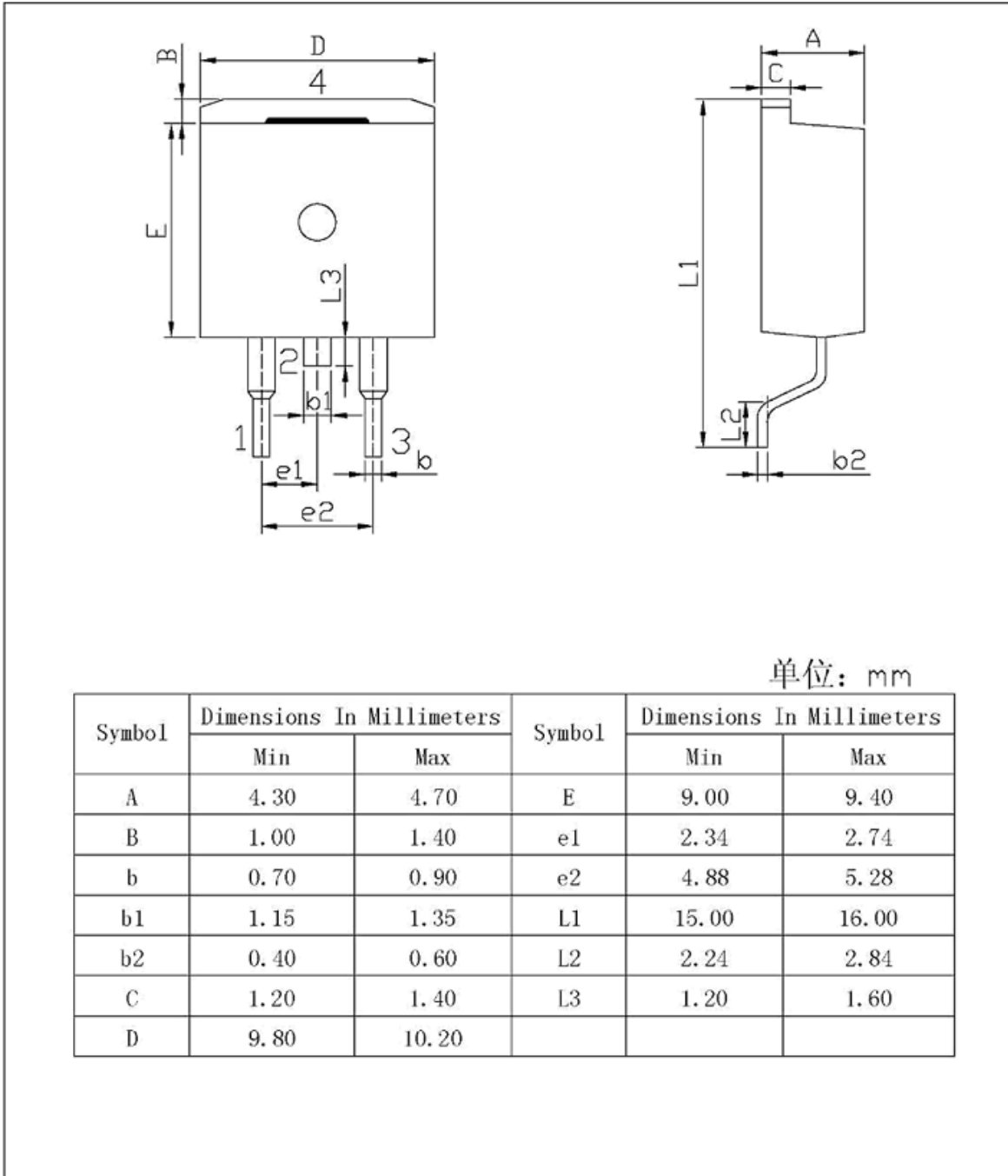

Figure1: Outline PG-T0263

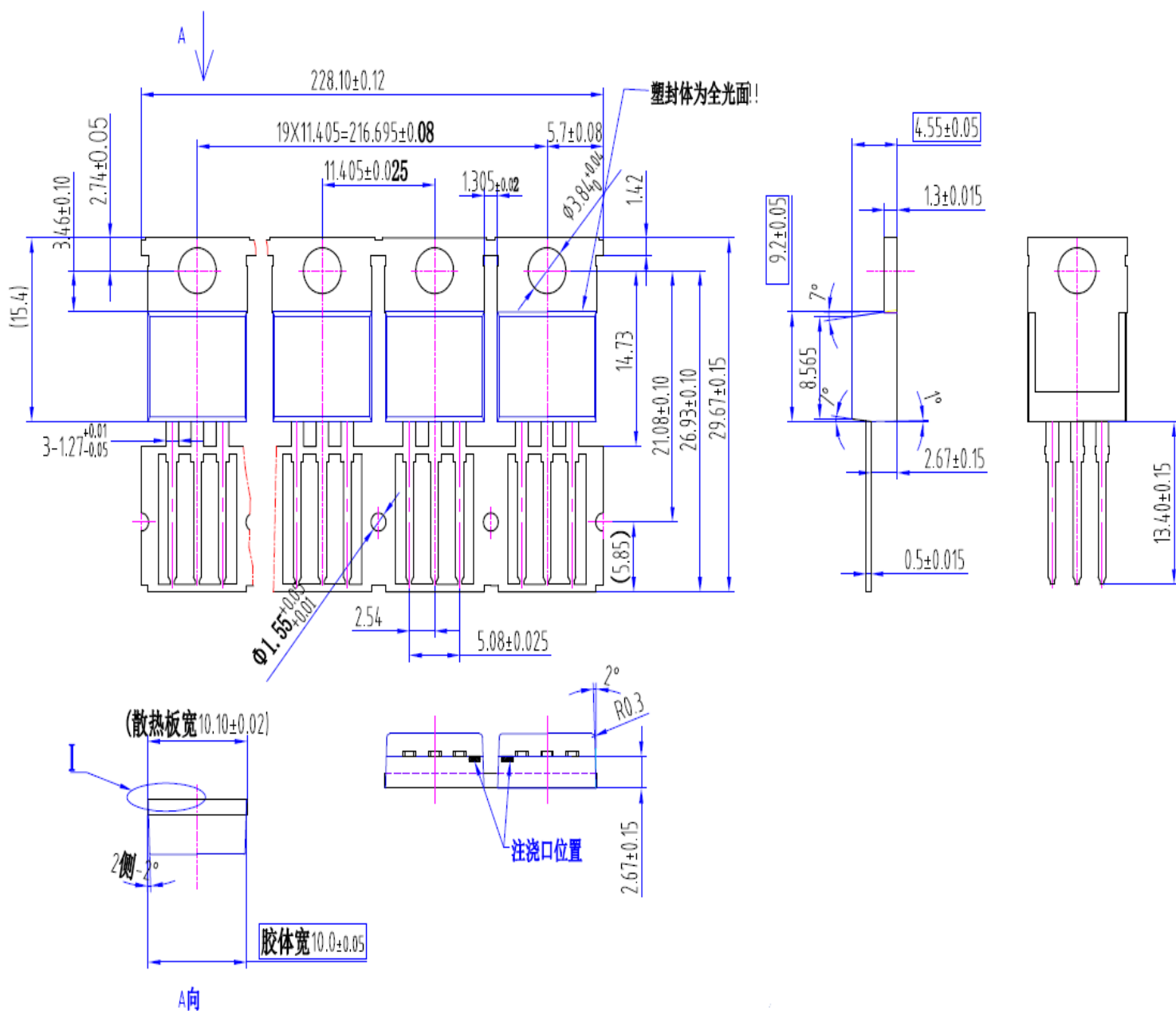

Figure2: Outline PG-T0220



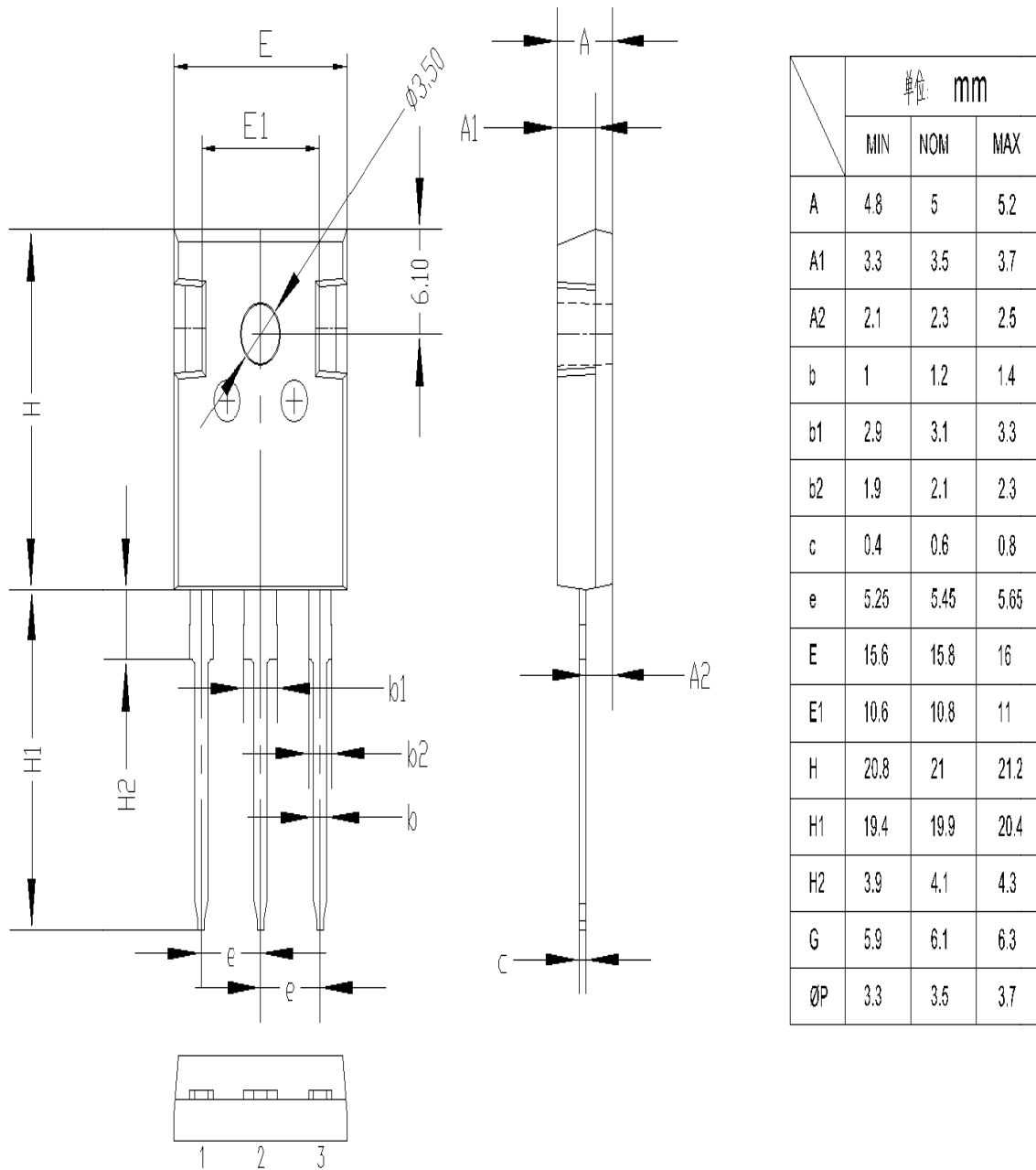

Figure3: Outline PG-T0247

---

## **Revision History**

Revision	Date	Subjects (major changes since last revision)
1.0	2021-06-1	Preliminary version

## X-ON Electronics

Largest Supplier of Electrical and Electronic Components

*Click to view similar products for [MOSFET](#) category:*

*Click to view products by [ANHI](#) manufacturer:*

Other Similar products are found below :

[IRFD120](#) [IRFY240C](#) [JANTX2N5237](#) [2SK2267\(Q\)](#) [BUK455-60A/B](#) [MIC4420CM-TR](#) [VN1206L](#) [NDP4060](#) [SI4482DY](#)  
[IPS70R2K0CEAKMA1](#) [SQD23N06-31L-GE3](#) [TK16J60W,S1VQ\(O](#) [2SK2614\(TE16L1,Q\)](#) [DMN1017UCP3-7](#) [EFC2J004NUZTDG](#)  
[DMN1053UCP4-7](#) [SQJ469EP-T1-GE3](#) [NTE2384](#) [DMC2700UDMQ-7](#) [DMN2080UCB4-7](#) [DMN61D9UWQ-13](#) [US6M2GTR](#)  
[DMN31D5UDJ-7](#) [DMP22D4UFO-7B](#) [DMN1006UCA6-7](#) [DMN16M9UCA6-7](#) [STF5N65M6](#) [IRF40H233XTMA1](#) [STU5N65M6](#)  
[DMN6022SSD-13](#) [DMN13M9UCA6-7](#) [DMTH10H4M6SPS-13](#) [DMN2990UFB-7B](#) [IPB80P04P405ATMA2](#) [2N7002W-G](#) [MCAC30N06Y-](#)  
[TP](#) [MCQ7328-TP](#) [NTMC083NP10M5L](#) [NVMFS2D3P04M8LT1G](#) [BXP7N65D](#) [BXP4N65F](#) [AOL1454G](#) [WMJ80N60C4](#) [BXP2N20L](#)  
[BXP2N65D](#) [BXT1150N10J](#) [BXT1700P06M](#) [TSM60NB380CP](#) [ROG](#) [RQ7L055BGTCR](#) [DMNH15H110SK3-13](#)