

规格承认书

APPROVED SHEET

客户 CUSTOMER:

立创商城

品名 PRODUCT :

碳膜电阻

规格 TYPE :

客户承认印
CUSTOMER APPROVED



东莞市粤翔电子科技有限公司
DongGuan City FlyWin electronic SCI-tech co.,Ltd

地址: 广东省东莞市企石镇新南管理区第二工业区





电话: 0769-86732558 传真: 0769-86666308

一式二份

粤翔一份

客户一份

出图
DRAWING

发行 ISSUE	业务 SALES	审核 AUDITING	核准 APPROVED
			

DATE: 2018年 12月 13 日

粤翔电子科技品保部

承认书编号 CR20181213001

FEATURES 特点

- 1 HIGH QUALITY
高品质.
- 2 WITHSTAND VOITAGE, SHOCK RESISTANCE
耐电压, 耐冲击
- 3 STANDARD TOLERANCE : ±5%, (±2%).
±5%, (±2%) 的标准误差
- 4 VARIETY OF PACKAGING-BULK 26mm AND 52mm TAPE, CUT AND FORMED
可供散装, 带装26mm/52mm, 成型剪脚.
- 5 HIGH RESISTANCE RANGE (0 Ω 1-10M Ω).
阻抗范围高 (0 Ω 1-10M Ω).



CONSTRUCTION 结构图

- 1 CERAMIC CORE (HIGH CONDUCTIVITY)
陶瓷棒心 (高热传导)
- 2 HIGH STABILITY FILM
高稳定性皮膜
- 3 END CAP (HIGH RELIABILITY FITTING BY ORIGINAL CAP-PRESSING METHOD)
端帽 (卯和度信赖性高)
- 4 HIGH INSULATION AND SOLVENT RESISTANCE OF EPOXY RESIN COATING
(BULK POWER TO KHAKI, MINIATURE PINK)
高绝缘及耐溶剂之环氧树脂涂料 (本体功率为土黄色, 小型化为粉红色)
- 5 COLOR CODE (PER MIL & EIA STANDARDS).
符合MIL & EIA规定之标准色码带。
- 6 LEAD WIRE (EXCELLENT SOLDER ABILITY)
焊锡性良好的导线
- 7 WELDING (LONG RELIABILITY GUARANTEE)
信赖性良好的焊接



SPECIFICATION: 规格描述

EXAMPLE 例:

CR1WS-9 Ω 1 ± 5%-XT52

CR

1WS

9 Ω 1

± 5%

X

T52

品名
PRODUCT

额定功率
RATED POWER

阻值范围
RESISTANCE RANGE

误差值
TOLERANCE

线径
WIRE DIAMETER

形状
SHAPE

CR	碳膜电阻
MF	金膜电阻
MO	氧化膜电阻
MGR	高压玻璃釉电阻
KNP	绕线电阻
NKNP	无感绕线电阻
FR	保险电阻
FRKNP	绕线保险电阻
SCF	高压脉冲电阻

1/8W	1/4WS
1/4W	1/2WS
1/2W	1WS
1W	2WS
2W	3WS
3W	5WS
5W	7WS

0 Ω 1-22M Ω
阻值表示方法
RESISTANCE VALUE REPRESENTATION
阻值单位按 Ω, K, M
1000 Ω = 1K 1000K = 1M
例: 9 Ω 1/5K6/4M7

± 10%
± 5%
± 2%
± 1%

0: 0.43CU	S: 0.43CP
2: 0.53CU	X: 0.53CP
6: 0.63CU	T: 0.63CP
9: 0.73CU	Q: 0.73CP
C: 0.83CU	D: 0.83CP
A: 0.75CU	

T26	编带26MM
T52	编带52MM
T63	编带63MM
T73	编带73MM
T93	编带93MM
P	散装
M、F	成型
FK/MB/TF	成型

NOTE1注解: RATED VOLTAGE 额定电压 =

$\sqrt{\text{POWER RATING 额定功率} * \text{RESISTANCE VALUE 公称阻值}}$

CHARACTERISTICS 特性项目	SPECIFICATIONS 规格值	TEST METHODS JIS C 5202 测试方法 JIS C 5202标准															
DC RESISTANCE 直流阻抗值	J (±5%)	RESISTANCE VALUE TEST AT ROOM TEMPERATURE 25°C 阻值测试在室温25°C															
T. C. R温度系数	<table border="1"> <tr> <td>1/8W 1/4WS</td> <td rowspan="7" style="text-align: center;"> $<10\Omega \pm 400PPM$ $10\Omega - 1M \pm 350PPM$ $>1M \pm 1000PPM$ </td> </tr> <tr> <td>1/4W 1/2WS</td> </tr> <tr> <td>1/2W 1WS</td> </tr> <tr> <td>1W 2WS</td> </tr> <tr> <td>2W 3WS</td> </tr> <tr> <td>3W 5WS</td> </tr> <tr> <td>5W 7WS</td> </tr> </table>	1/8W 1/4WS	$<10\Omega \pm 400PPM$ $10\Omega - 1M \pm 350PPM$ $>1M \pm 1000PPM$	1/4W 1/2WS	1/2W 1WS	1W 2WS	2W 3WS	3W 5WS	5W 7WS	$\frac{R2-R1}{R1(T2-T1)} \times 10^6 PPM/^\circ C$ R1: RESISTANCE VALUE AT ROOM TEMPERATURE (T1) 常温 (T1) 阻抗值 R2: RESISTANCE VALUE AT ROOM TEMPERATURE +100°C (T2) 常温+100°C 阻抗值							
1/8W 1/4WS	$<10\Omega \pm 400PPM$ $10\Omega - 1M \pm 350PPM$ $>1M \pm 1000PPM$																
1/4W 1/2WS																	
1/2W 1WS																	
1W 2WS																	
2W 3WS																	
3W 5WS																	
5W 7WS																	
LOAD LIFE IN HUMIDITY 湿度寿命	RESISTANCE CHANGE RATE $\pm(5\%+0.05\Omega)$ WITH NO EVIDENCE OF RESISTOR DAMAGE. 阻抗值变化率 (5%±0.05Ω)，电阻器不可有损伤	RESISTANCE CHANGE AFTER 1000H (1.5H ON, 0.5H OFF) AT RATED VOLTAGE IN A HUMIDITY CHAMBER CONTROLLED AT 40+/-2°C AND 90-95% RELATIVE HUMIDITY. (when the test voltage exceeds the working voltage, considering the working voltage) 温度40+/-2°C，相对湿度90-95%于恒温恒湿箱中，加额定直流电压测试1.5小时停止0.5小时，连续1000小时。(当实验电压超过最高使用电压，采用最高使用电压)															
LOAD LIFE 温度寿命	RESISTANCE CHANGE RATE $\pm(5\%+0.05\Omega)$ MAX WITH NO EVIDENCE OF RESISTOR DAMAGE. 阻抗值变化率 (5%±0.05Ω)，电阻器不可有损伤	RESISTANCE CHANGE AFTER 1000H OPERATING AT RATED VOLTAGE WITH DUTY CYCLE OF 1.5H ON 0.5H OFF AT 70°C±2°C (when the test voltage exceeds the working voltage, considering the working voltage) 温度70+/-2°C，加额定直流电压测试1.5小时停止0.5小时，连续1000小时(当实验电压超过最高使用电压时，采用最高使用电压)															
SHORT TIME OVER LOAD 短时间过负荷	$\pm(1\%+0.05\Omega)$	RESISTANCE CHANGE AFTER THE APPLICATION OF A POTENTIAL OF 2.5T RATED VOLTAGE FOR 5 SE (when the test voltage exceeds the maximum overload, consider using the maximum overload voltage) 额定电压X2.5倍，测试5秒(当实验电压超过最高过负荷电压，采用最高过负荷电压)															
PULSE OVER LOAD 断续过负荷	1/8W, 1/4W, 1/2W, 1W, 2W, 3W, 5W	$\pm(1\%+0.05\Omega)$	RESISTANCE CHANGE AFTER 10000C (1SEC ON, 25SEC OFF) AT 4T RATED VOLTAGE (AC) when the test voltage exceeds the maximum overload, consider using the maximum overload voltage) 额定电压*4倍(交流电压)，测试1秒停止25秒，测试10000次。(当实验电压超过最高过负荷电压，采用最高过负荷电压)														
	1/4WS, 1/2WS, 1WS, 2WS, 3WS, 5WS, 7WS	$\pm(2\%+0.05\Omega)$	RESISTANCE CHANGE AFTER 10000C (1SEC ON, 25SEC OFF) AT 4T RATED VOLTAGE (AC) when the test voltage exceeds the maximum overload, consider using the maximum overload voltage) 额定电压*4倍(交流电压)，测试1秒停止25秒，测试10000次。(当实验电压超过最高过负荷电压，采用最高过负荷电压)														
RESISTANCE TO SOLVENT 耐溶剂性	NO VISIBLE DAMAGES TO PROTECTIVE COATING AND MARKING (外观无异样，标识能够清楚易辨)	SOAK 3MIN IN THE MELTING AGENT TO AGAIN AND AGAIN WIPE 10 TIMES (三氯乙稀浸泡3分钟，再用湿布反复擦拭10次)															
INSULATION RESISTANCE 绝缘阻抗	$>1000M\Omega$																
ELECTRIC WITHSTANDING VOLTAGE 绝缘耐电压	RESISTANCE CHANGE RATE $\pm(1\%+0.05\Omega)$ WITH NO EVIDENCE OR RESISTOR DAMAGE. 阻抗值变化率 $\pm(1\%+0.05\Omega) ELECTRIC RESISTANCE BOTH ENDS THE CONJUNCTION LINE PUT ON THE METALS V TYPE THE SLOT, ACCORDING TO THE ELECTRIC VOLTAGE PROVISION OF THE CHARACTERISTIC WATCH 60 SECONDS INFLECTION电阻两端导线置于金属V型槽上，依特性表之电压规定施加60秒 $	ELECTRIC RESISTANCE BOTH ENDS THE CONJUNCTION LINE PUT ON THE METALS V TYPE THE SLOT, ACCORDING TO THE ELECTRIC VOLTAGE PROVISION OF THE CHARACTERISTIC WATCH 60 SECONDS INFLECTION 电阻两端导线置于金属V型槽上，依特性表之电压规定施加60秒															
TEMPERATURE CYCLING 温度循环	RESISTANCE CHANGE RATE IS $\pm(1\%+0.05\Omega)$ MAX, WITH NO EVIDENCE OF RESISTOR DAMAGE. 阻抗值变化率 $\pm(1\%+0.05\Omega)$ 以内，电阻器不可有损伤	<table border="1"> <thead> <tr> <th>STEP 步骤、</th> <th>TEMPERATURE 温度</th> <th>TIME (MIN) 放置时间</th> </tr> </thead> <tbody> <tr> <td>1</td> <td>-55°C±2°C</td> <td>30</td> </tr> <tr> <td>2</td> <td>ROOM TEMP 室温</td> <td>10-15</td> </tr> <tr> <td>3</td> <td>85°C±2°C</td> <td>30</td> </tr> <tr> <td>4</td> <td>ROOM TEMP 室温</td> <td>10-15</td> </tr> </tbody> </table>	STEP 步骤、	TEMPERATURE 温度	TIME (MIN) 放置时间	1	-55°C±2°C	30	2	ROOM TEMP 室温	10-15	3	85°C±2°C	30	4	ROOM TEMP 室温	10-15
STEP 步骤、	TEMPERATURE 温度	TIME (MIN) 放置时间															
1	-55°C±2°C	30															
2	ROOM TEMP 室温	10-15															
3	85°C±2°C	30															
4	ROOM TEMP 室温	10-15															
RESISTANCE TO SOLDERING HEAT 耐热性	RESISTANCE CHANGE RATE IS $\pm(2\%+0.05\Omega)$ MAX, WITH NO EVIDENCE OF RESISTOR DAMAGE. 阻抗值变化率 (2%±0.05Ω) 以内，电阻器不可有损伤	PUT THE LEAD LINE OF RESISTANCE INTO THE SOLDERING ABOUT 3.2 TO 4.8MM PLEASE TAKE IMPLEMENTATION ON THE BASIS OF THE TABLE BELOW 将电阻两端导线浸入锡炉约3.2至4.8mm依下表规定实施 <table border="1"> <thead> <tr> <th>TEMPERATURE 温度</th> <th>DIP TIME 放置时间</th> </tr> </thead> <tbody> <tr> <td>350°C±10°C</td> <td>3±0.5 SEC</td> </tr> <tr> <td>260°C±5°C</td> <td>10±1.0 SEC</td> </tr> </tbody> </table>	TEMPERATURE 温度	DIP TIME 放置时间	350°C±10°C	3±0.5 SEC	260°C±5°C	10±1.0 SEC									
TEMPERATURE 温度	DIP TIME 放置时间																
350°C±10°C	3±0.5 SEC																
260°C±5°C	10±1.0 SEC																
SOLDERABILITY 焊锡性	95% COVERAGE MINIMUM 95%覆盖于导线上	TEST TEMPERATURE OF SOLDER: 230°C±5°C DWELL TIME IN SOLDER: 3±0.5 SEC 锡炉温度: 230°C±5°C 浸锡时间: 3±0.5 秒															
SOLDER JOINT PULL 焊点拉力	PULLING TEST FOR 1/8W≥1.8KG, 1/4W≥3.8KG, 1/2W BIGGER THAN ≥5KG 拉力强度 1/8W≥1.8KG, 1/4W≥3.8KG, 1/2W 含以上 ≥5KG	SECURE BOTH LEAD WIRE ON EACH SIDE OF PULLING MACHING AND THEN PULL IT 将成品电阻铜线一端夹在拉力器的一端，铜线另一端也夹在拉力器上，再摇动拉力器															
Life & failure rate 寿命失效率	Under the rated condition Use Lire ≥ 10000H 额定条件下使用寿命 ≥ 10000小时	failure rate ≤ 10PPM 失效率 ≤ 10PPM															

POWER CHARACTERISTIC 电力特性

POWER PATED 额定功率	0.125W (1/8W)	0.25WS (1/4W)S	0.25W (1/4W)	0.5WS (1/2W)S	0.5W (1/2W)	1WS	1W	2WS	2W	3WS	3W	5WS	5W	7WS
MAX WORKING VOLTAGE 最高使用电压	200V	250V	250V	350V	350V	500V	500V	500V	500V	500V	500V	500V	750V	750V
MAX OVERLOAD VOLTAGE 最高过负荷电压	400V	500V	500V	700V	700V	1000V	1000V	1000V	1000V	1000V	1000V	1000V	1000V	1000V
MAX INTERMITTENCE OVER LOAD VOLTAGE 最高断续过负荷	400V	500V	500V	700V	700V	1000V	1000V	1000V	1000V	1000V	1000V	1000V	1000V	1000V
ELECTRIC WITHSTANDING VOLTAGE 绝缘耐电压	300V	300V	400V	400V	500V	500V	700V	700V	700V	700V	700V	700V	700V	700V
RESISTANCE TOLERANCE 阻抗误差值	J (±5%) G (±2%)													
RANGE (OHM) 阻抗值范围	MIN	0.1 Ω	0.1 Ω	0.1 Ω	0.1 Ω	0.1 Ω	0.1 Ω	0.1 Ω	0.1 Ω	0.1 Ω	0.1 Ω	0.1 Ω	0.1 Ω	0.1 Ω
	MAX	22M Ω	22M Ω	22M Ω	22M Ω	22M Ω	22M Ω	22M Ω	22M Ω	22M Ω	22M Ω	22M Ω	22M Ω	22M Ω

NOTE注解: 1M ohm is high risk resistance for thin film resistors.

薄膜电阻1M以上阻值为高风险阻值

POWER DERATING CURVE 负载衰减曲线

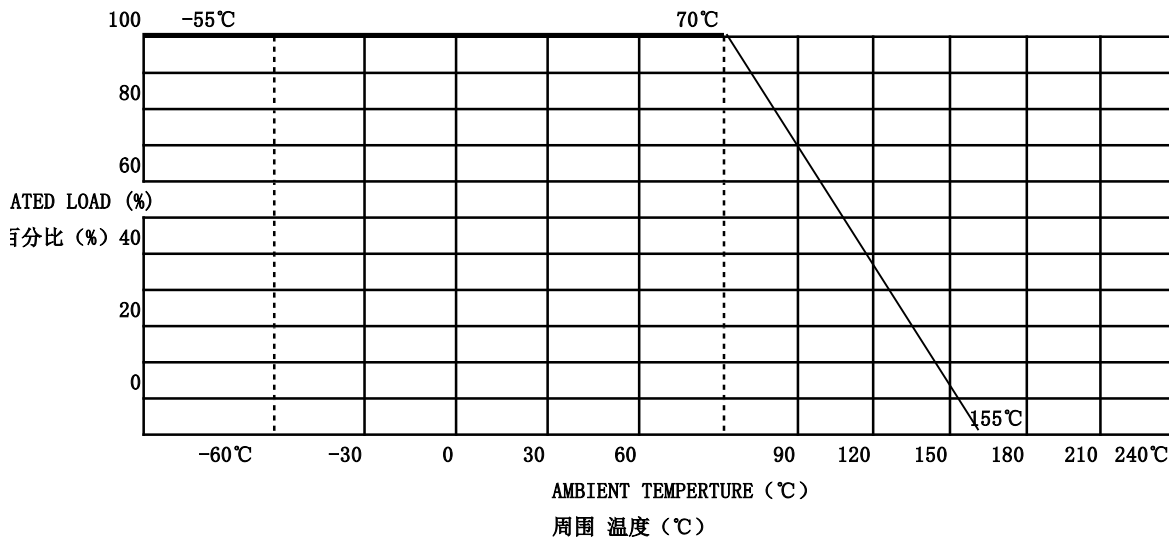

NOTE注解:

- 1 RATED AMBIENT TEMPERATURE : 70°C
额定周围温度: 70°C
- 2 OPERATING TEMPERATURE RANGE: -55°C ~ +155°C
使用温度范围: -55°C ~ +155°C
- 3 FOR RESISTORS IPERATED IN AMBIENT TEMPERATURE OVER 70°C, POWER RATING SHALL BE DERATED IN ACCORDANCE WITH THE FIGURE
周围温度70°C以上使用时, 根据降功率曲线将减轻额定功率

BULK TYPE DIMENSION (TO TYPE)

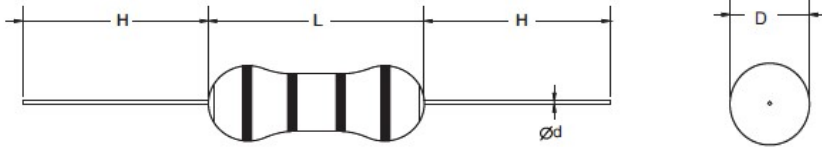

TYPE	LEAD TYPING DIMENSION (mm)			
	L±1.0	D±1.0	Φd±0.05	H±3.0
1/8W 1/4WS	3.7	2.3	0.43	26
1/4W 1/2WS	6.2	2.7	0.43	26
1/2W 1WS	9	3.5	0.53	26
1W 2WS	11	4.5	0.63	31
2W 3WS	15.5	5	0.73	31
3W 5WS	17.5	6	0.73	31
5W 7WS	25	8	0.83	39

TO TYPE

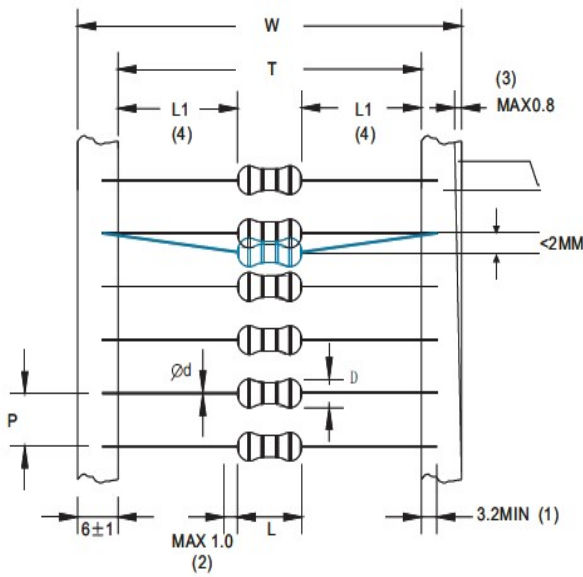

TYPE	LEAD TYPING DIMENSION (mm)							
	T	+1.5 -0.0	D±1.0	Φd±0.05	P±0.3	L±1.0	T	+2.0 -0.0
1/8W 1/4WS	26		2.3	0.43	5	3.7	38	
	52						64	
1/4W 1/2WS	26		2.7	0.43	5	6.2	38	
	52						64	
1/2W 1WS	52		3.5	0.53	5	9	64	
1W 2WS	63		4.5	0.63	5	11	75	
2W 3WS	73		5	0.73	10	15.5	85	
3W 5WS	73		6	0.73	10	17.5	85	
5W 7WS	93		8	0.83	10	25	105	

- LEAD DIMENSIONS INCLUDED IN TAPE
纸带内缘导线长度
- LEAD PAINT DIMENSION
涂漆于导线上的长度
- DIFFERENCE OF A & B
A带与B带的位差
- [L1-L2]<1.0MM
左右边差小于1.0MM

X-ON Electronics

Largest Supplier of Electrical and Electronic Components

Click to view similar products for [Thick Film Resistors - Through Hole](#) category:

Click to view products by [Anhui VICO](#) manufacturer:

Other Similar products are found below :

[M8340104K3300GCD03](#) [M8340105K3300GGD03](#) [M8340105K3922FGD03](#) [M8340107K2401GCD03](#) [M8340109K1002JCD03](#)

[M8340109K1003GCD03](#) [MP850-3.00-1%](#) [ARC3.11 2M J A](#) [M8340105K1003GCD03](#) [M8340105M2201GCD03](#) [M8340107M7501GCD03](#)

[M8340108K2051FCD03](#) [M8340108K7501GCD03](#) [M8340108M5100JGD03](#) [M8340109K1000GCD03](#) [MOX-GRD-001](#)

[M8340102M4701GBD04](#) [M8340102K1002GBD04](#) [M8340109K2002GGD03](#) [M8340108K2002FGD03](#) [OE1305](#) [MS-221-82R5](#) [MOX-](#)

[750231004DE](#) [MOX-4-127505J](#) [SM102034504FE](#) [MOX300002206FE](#) [MOX-400233004F](#) [MOX300001005BE](#) [SM104066008J](#) [MOX-](#)

[400262008PE](#) [MOX-400232506FE](#) [MOX-400234007FE](#) [MOX-400221006G](#) [MOX-750235006ME](#) [SM103032506FE](#) [SM202022005FE](#)

[MOX1125231002FE](#) [MOX-1-122504F](#) [MOX-400225003F](#) [MOX1125731008FE](#) [MOX-5-126002JE](#) [MS176-2.20M-1%](#) [MOX-830212453BE](#)

[TRHE01A270RJ2E](#) [TRHE01A560RJ2E](#) [TRHP01A200RF2E](#) [TRHP01A5001F2E](#) [MG715-2.40M-1%](#) [MS214-20.0K-1%](#) [MF0W4FF4702A50](#)