

规格承认书

APPROVED SHEET

客户 CUSTOMER:

立创商城

品名 PRODUCT :

碳膜电阻

规格 TYPE :

客户承认印
CUSTOMER APPROVED



东莞市粤翔电子科技有限公司
DongGuan City FlyWin electronic SCI-tech co.,Ltd

地址: 广东省东莞市企石镇新南管理区第二工业区





电话: 0769-86732558 传真: 0769-86666308

一式二份

粤翔一份

客户一份

出图
DRAWING

| 发行 ISSUE | 业务 SALES | 审核 AUDITING | 核准 APPROVED |
|---|---|---|--|
|  |  |  |  |

DATE: 2018年 12月 13 日

粤翔电子科技品保部

承认书编号 CR20181213001

FEATURES 特点

- 1 HIGH QUALITY
高品质.
- 2 WITHSTAND VOITAGE, SHOCK RESISTANCE
耐电压, 耐冲击
- 3 STANDARD TOLERANCE : ±5%, (±2%).
±5%, (±2%) 的标准误差
- 4 VARIETY OF PACKAGING-BULK 26mm AND 52mm TAPE, CUT AND FORMED
可供散装, 带装26mm/52mm, 成型剪脚.
- 5 HIGH RESISTANCE RANGE (0 Ω 1-10M Ω).
阻抗范围高 (0 Ω 1-10M Ω).



CONSTRUCTION 结构图

- 1 CERAMIC CORE (HIGH CONDUCTIVITY)
陶瓷棒心 (高热传导)
- 2 HIGH STABILITY FILM
高稳定性皮膜
- 3 END CAP (HIGH RELIABILITY FITTING BY ORIGINAL CAP-PRESSING METHOD)
端帽 (卯和度信赖性高)
- 4 HIGH INSULATION AND SOLVENT RESISTANCE OF EPOXY RESIN COATING
(BULK POWER TO KHAKI, MINIATURE PINK)
高绝缘及耐溶剂之环氧树脂涂料 (本体功率为土黄色, 小型化为粉红色)
- 5 COLOR CODE (PER MIL& EIA STANDARDS).
符合MIL & EIA规定之标准色码带。
- 6 LEAD WIRE (EXCELLENT SOLDER ABILITY)
焊锡性良好的导线
- 7 WELDING (LONG RELIABILITY GUARANTEE)
信赖性良好的焊接



SPECIFICATION: 规格描述

EXAMPLE 例:

CR1WS-9 Ω 1 ± 5%-XT52

CR

1WS

9 Ω 1

± 5%

X

T52

品名
PRODUCT

额定功率
RATED POWER

阻值范围
RESISTANCE RANGE

误差值
TOLERANCE

线径
WIRE DIAMETER

形状
SHAPE

| | |
|-------|---------|
| CR | 碳膜电阻 |
| MF | 金膜电阻 |
| MO | 氧化膜电阻 |
| MGR | 高压玻璃釉电阻 |
| KNP | 绕线电阻 |
| NKNP | 无感绕线电阻 |
| FR | 保险电阻 |
| FRKNP | 绕线保险电阻 |
| SCF | 高压脉冲电阻 |

| | |
|------|-------|
| 1/8W | 1/4WS |
| 1/4W | 1/2WS |
| 1/2W | 1WS |
| 1W | 2WS |
| 2W | 3WS |
| 3W | 5WS |
| 5W | 7WS |

| |
|---------------------------------|
| 0 Ω 1-22M Ω |
| 阻值表示方法 |
| RESISTANCE VALUE REPRESENTATION |
| 阻值单位按 Ω, K, M |
| 1000 Ω = 1K 1000K = 1M |
| 例: 9 Ω 1/5K6/4M7 |

| |
|-------|
| ± 10% |
| ± 5% |
| ± 2% |
| ± 1% |

| | |
|-----------|-----------|
| 0: 0.43CU | S: 0.43CP |
| 2: 0.53CU | X: 0.53CP |
| 6: 0.63CU | T: 0.63CP |
| 9: 0.73CU | Q: 0.73CP |
| C: 0.83CU | D: 0.83CP |
| A: 0.75CU | |

| | |
|----------|--------|
| T26 | 编带26MM |
| T52 | 编带52MM |
| T63 | 编带63MM |
| T73 | 编带73MM |
| T93 | 编带93MM |
| P | 散装 |
| M、F | 成型 |
| FK/MB/TF | 成型 |

NOTE1注解: RATED VOLTAGE 额定电压 =

$\sqrt{\text{POWER RATING 额定功率} * \text{RESISTANCE VALUE 公称阻值}}$



CARBON FILM FIXED RESISTORS 碳膜固定电阻器

FLYWIN

| CHARACTERISTICS 特性项目 | SPECIFICATIONS 规格值 | TEST METHODS JIS C 5202 测试方法 JIS C 5202标准 | | | | | | | | | | | | | | | |
|--|---|---|--|----------------|-----------------|-----------|-----------|------------|--------|--|-------|---|----------|----|---|--------------|-------|
| DC RESISTANCE 直流阻抗值 | J (±5%) | RESISTANCE VALUE TEST AT ROOM TEMPERATURE 25°C 阻值测试在室温25°C | | | | | | | | | | | | | | | |
| T. C. R温度系数 | <table border="1"> <tr> <td>1/8W 1/4WS</td> <td rowspan="7" style="text-align: center;"> $<10\Omega \pm 400\text{PPM}$ $10\Omega - 1M \pm 350\text{PPM}$ $>1M \pm 1000\text{PPM}$ </td> </tr> <tr> <td>1/4W 1/2WS</td> </tr> <tr> <td>1/2W 1WS</td> </tr> <tr> <td>1W 2WS</td> </tr> <tr> <td>2W 3WS</td> </tr> <tr> <td>3W 5WS</td> </tr> <tr> <td>5W 7WS</td> </tr> </table> | 1/8W 1/4WS | $<10\Omega \pm 400\text{PPM}$ $10\Omega - 1M \pm 350\text{PPM}$ $>1M \pm 1000\text{PPM}$ | 1/4W 1/2WS | 1/2W 1WS | 1W 2WS | 2W 3WS | 3W 5WS | 5W 7WS | $\frac{R2-R1}{R1(T2-T1)} \times 10^6 \text{PPM}/^\circ\text{C}$ R1: RESISTANCE VALUE AT ROOM TEMPERATURE (T1) 常温 (T1) 阻抗值 R2: RESISTANCE VALUE AT ROOM TEMPERATURE +100°C (T2) 常温+100°C 阻抗值 | | | | | | | |
| 1/8W 1/4WS | $<10\Omega \pm 400\text{PPM}$ $10\Omega - 1M \pm 350\text{PPM}$ $>1M \pm 1000\text{PPM}$ | | | | | | | | | | | | | | | | |
| 1/4W 1/2WS | | | | | | | | | | | | | | | | | |
| 1/2W 1WS | | | | | | | | | | | | | | | | | |
| 1W 2WS | | | | | | | | | | | | | | | | | |
| 2W 3WS | | | | | | | | | | | | | | | | | |
| 3W 5WS | | | | | | | | | | | | | | | | | |
| 5W 7WS | | | | | | | | | | | | | | | | | |
| LOAD LIFE IN HUMIDITY 湿度寿命 | RESISTANCE CHANGE RATE $\pm(5\%+0.05\Omega)$ WITH NO EVIDENCE OF RESISTOR DAMAGE. 阻抗值变化率 (5%±0.05Ω), 电阻器不可有损伤 | RESISTANCE CHANGE AFTER 1000H (1.5H ON, 0.5H OFF) AT RATED VOLTAGE IN A HUMIDITY CHAMBER CONTROLLED AT 40+/-2°C AND 90-95% RELATIVE HUMIDITY. (when the test voltage exceeds the working voltage, considering the working voltage) 温度40+/-2°C, 相对湿度90-95%于恒温恒湿箱中, 加额定直流电压测试1.5小时停止0.5小时, 连续1000小时。(当实验电压超过最高使用电压, 采用最高使用电压) | | | | | | | | | | | | | | | |
| LOAD LIFE 温度寿命 | RESISTANCE CHANGE RATE $\pm(5\%+0.05\Omega)$ MAX WITH NO EVIDENCE OF RESISTOR DAMAGE. 阻抗值变化率 (5%±0.05Ω), 电阻器不可有损伤 | RESISTANCE CHANGE AFTER 1000H OPERATING AT RATED VOLTAGE WITH DUTY CYCLE OF 1.5H ON 0.5H OFF AT 70°C±2°C (when the test voltage exceeds the working voltage, considering the working voltage) 温度70+/-2°C, 加额定直流电压测试1.5小时停止0.5小时, 连续1000小时 (当实验电压超过最高使用电压时, 采用最高使用电压) | | | | | | | | | | | | | | | |
| SHORT TIME OVER LOAD 短时间过负荷 | $\pm(1\%+0.05\Omega)$ | RESISTANCE CHANGE AFTER THE APPLICATION OF A POTENTIAL OF 2.5T RATED VOLTAGE FOR 5 SE (when the test voltage exceeds the maximum overload, consider using the maximum overload voltage) 额定电压X2.5倍, 测试5秒 (当实验电压超过最高过负荷电压, 采用最高过负荷电压) | | | | | | | | | | | | | | | |
| PULSE OVER LOAD 断续过负荷 | 1/8W, 1/4W, 1/2W, 1W, 2W, 3W, 5W | $\pm(1\%+0.05\Omega)$ | RESISTANCE CHANGE AFTER 10000C (1SEC ON, 25SEC OFF) AT 4T RATED VOLTAGE (AC) when the test voltage exceeds the maximum overload, consider using the maximum overload voltage) 额定电压*4倍 (交流电压), 测试1秒停止25秒, 测试10000次。(当实验电压超过最高过负荷电压, 采用最高过负荷电压) | | | | | | | | | | | | | | |
| | 1/4WS, 1/2WS, 1WS, 2WS, 3WS, 5WS, 7WS | $\pm(2\%+0.05\Omega)$ | RESISTANCE CHANGE AFTER 10000C (1SEC ON, 25SEC OFF) AT 4T RATED VOLTAGE (AC) when the test voltage exceeds the maximum overload, consider using the maximum overload voltage) 额定电压*4倍 (交流电压), 测试1秒停止25秒, 测试10000次。(当实验电压超过最高过负荷电压, 采用最高过负荷电压) | | | | | | | | | | | | | | |
| RESISTANCE TO SOLVENT 耐溶剂性 | NO VISIBLE DAMAGES TO PROTECTIVE COATING AND MARKING (外观无异样, 标识能够清楚易辨) | SOAK 3MIN IN THE MELTING AGENT TO AGAIN AND AGAIN WIPE 10 TIMES (三氯乙稀浸泡3分钟, 再用湿布反复擦拭10次) | | | | | | | | | | | | | | | |
| INSULATION RESISTANCE 绝缘阻抗 | $>1000M\Omega$ | | | | | | | | | | | | | | | | |
| ELECTRIC WITHSTANDING VOLTAGE 绝缘耐电压 | RESISTANCE CHANGE RATE $\pm(1\%+0.05\Omega)$ WITH NO EVIDENCE OR RESISTOR DAMAGE. 阻抗值变化率 $\pm(1\%+0.05\Omega)$, 电阻器不可有损伤 | ELECTRIC RESISTANCE BOTH ENDS THE CONJUNCTION LINE PUT ON THE METALS V TYPE THE SLOT, ACCORDING TO THE ELECTRIC VOLTAGE PROVISION OF THE CHARACTERISTIC WATCH 60 SECONDS INFLICTION 电阻两端导线置于金属V型槽上, 依特性表之电压规定施加60秒 | | | | | | | | | | | | | | | |
| TEMPERATURE CYCLING 温度循环 | RESISTANCE CHANGE RATE IS $\pm(1\%+0.05\Omega)$ MAX, WITH NO EVIDENCE OF RESISTOR DAMAGE. 阻抗值变化率 $\pm(1\%+0.05\Omega)$ 以内, 电阻器不可有损伤 | <table border="1"> <thead> <tr> <th>STEP 步骤、</th> <th>TEMPERATURE 温度</th> <th>TIME (MIN) 放置时间</th> </tr> </thead> <tbody> <tr> <td>1</td> <td>-55°C±2°C</td> <td>30</td> </tr> <tr> <td>2</td> <td>ROOM TEMP 室温</td> <td>10-15</td> </tr> <tr> <td>3</td> <td>85°C±2°C</td> <td>30</td> </tr> <tr> <td>4</td> <td>ROOM TEMP 室温</td> <td>10-15</td> </tr> </tbody> </table> | STEP 步骤、 | TEMPERATURE 温度 | TIME (MIN) 放置时间 | 1 | -55°C±2°C | 30 | 2 | ROOM TEMP 室温 | 10-15 | 3 | 85°C±2°C | 30 | 4 | ROOM TEMP 室温 | 10-15 |
| STEP 步骤、 | TEMPERATURE 温度 | TIME (MIN) 放置时间 | | | | | | | | | | | | | | | |
| 1 | -55°C±2°C | 30 | | | | | | | | | | | | | | | |
| 2 | ROOM TEMP 室温 | 10-15 | | | | | | | | | | | | | | | |
| 3 | 85°C±2°C | 30 | | | | | | | | | | | | | | | |
| 4 | ROOM TEMP 室温 | 10-15 | | | | | | | | | | | | | | | |
| RESISTANCE TO SOLDERING HEAT 耐热性 | RESISTANCE CHANGE RATE IS $\pm(2\%+0.05\Omega)$ MAX, WITH NO EVIDENCE OF RESISTOR DAMAGE. 阻抗值变化率 (2%±0.05Ω) 以内, 电阻器不可有损伤 | PUT THE LEAD LINE OF RESISTANCE INTO THE SOLDERING ABOUT 3.2 TO 4.8MM PLEASE TAKE IMPLEMENTATION ON THE BASIS OF THE TABLE BELOW 将电阻两端导线浸入锡炉约3.2至4.8mm依下表规定实施 <table border="1"> <thead> <tr> <th>TEMPERATURE 温度</th> <th>DIP TIME 放置时间</th> </tr> </thead> <tbody> <tr> <td>350°C±10°C</td> <td>3±0.5 SEC</td> </tr> <tr> <td>260°C±5°C</td> <td>10±1.0 SEC</td> </tr> </tbody> </table> | TEMPERATURE 温度 | DIP TIME 放置时间 | 350°C±10°C | 3±0.5 SEC | 260°C±5°C | 10±1.0 SEC | | | | | | | | | |
| TEMPERATURE 温度 | DIP TIME 放置时间 | | | | | | | | | | | | | | | | |
| 350°C±10°C | 3±0.5 SEC | | | | | | | | | | | | | | | | |
| 260°C±5°C | 10±1.0 SEC | | | | | | | | | | | | | | | | |
| SOLDERABILITY 焊锡性 | 95% COVERAGE MINIMUM 95%覆盖于导线上 | TEST TEMPERATURE OF SOLDER: 230°C±5°C DWELL TIME IN SOLDER: 3±0.5 SEC 锡炉温度: 230°C±5°C 浸锡时间: 3±0.5 秒 | | | | | | | | | | | | | | | |
| SOLDER JOINT PULL 焊点拉力 | PULLING TEST FOR 1/8W≥1.8KG, 1/4W≥3.8KG, 1/2W BIGGER THAN ≥5KG 拉力强度 1/8W≥1.8KG, 1/4W≥3.8KG, 1/2W 含以上 ≥5KG | SECURE BOTH LEAD WIRE ON EACH SIDE OF PULLING MACHING AND THEN PULL IT 将成品电阻铜线一端夹在拉力器的一端, 铜线另一端也夹在拉力器上, 再摇动拉力器 | | | | | | | | | | | | | | | |
| Life & failure rate 寿命失效率 | Under the rated condition Use Lire ≥ 10000H 额定条件下使用寿命 ≥ 10000小时 | failure rate ≤ 10PPM 失效率 ≤ 10PPM | | | | | | | | | | | | | | | |

POWER CHARACTERISTIC 电力特性

| POWER PATED 额定功率 | 0.125W (1/8W) | 0.25WS (1/4W)S | 0.25W (1/4W) | 0.5WS (1/2W)S | 0.5W (1/2W) | 1WS | 1W | 2WS | 2W | 3WS | 3W | 5WS | 5W | 7WS |
|---|------------------|-------------------|-----------------|------------------|----------------|-------|-------|-------|-------|-------|-------|-------|-------|-------|
| MAX WORKING VOLTAGE 最高使用电压 | 200V | 250V | 250V | 350V | 350V | 500V | 500V | 500V | 500V | 500V | 500V | 500V | 750V | 750V |
| MAX OVERLOAD VOLTAGE 最高过负荷电压 | 400V | 500V | 500V | 700V | 700V | 1000V | 1000V | 1000V | 1000V | 1000V | 1000V | 1000V | 1000V | 1000V |
| MAX INTERMITTENCE OVER LOAD VOLTAGE 最高断续过负荷 | 400V | 500V | 500V | 700V | 700V | 1000V | 1000V | 1000V | 1000V | 1000V | 1000V | 1000V | 1000V | 1000V |
| ELECTRIC WITHSTANDING VOLTAGE 绝缘耐电压 | 300V | 300V | 400V | 400V | 500V | 500V | 700V | 700V | 700V | 700V | 700V | 700V | 700V | 700V |
| RESISTANCE TOLERANCE 阻抗误差值 | J (±5%) G (±2%) | | | | | | | | | | | | | |
| RANGE (OHM) 阻抗值范围 | MIN | 0.1 Ω | 0.1 Ω | 0.1 Ω | 0.1 Ω | 0.1 Ω | 0.1 Ω | 0.1 Ω | 0.1 Ω | 0.1 Ω | 0.1 Ω | 0.1 Ω | 0.1 Ω | 0.1 Ω |
| | MAX | 22M Ω | 22M Ω | 22M Ω | 22M Ω | 22M Ω | 22M Ω | 22M Ω | 22M Ω | 22M Ω | 22M Ω | 22M Ω | 22M Ω | 22M Ω |

NOTE注解: 1M ohm is high risk resistance for thin film resistors.

薄膜电阻1M以上阻值为高风险阻值

POWER DERATING CURVE 负载衰减曲线

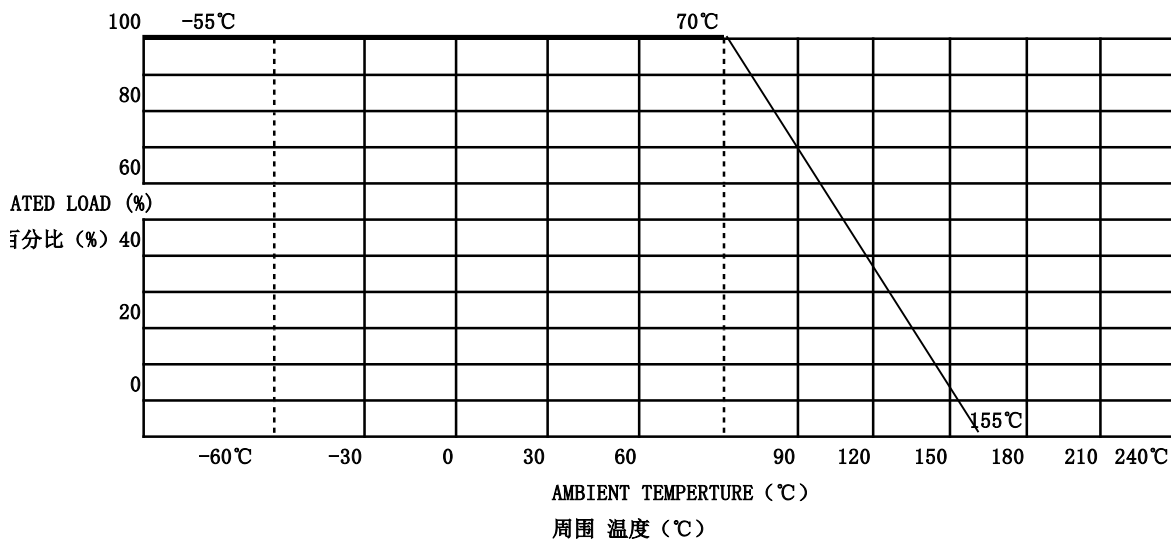

NOTE注解:

- 1 RATED AMBIENT TEMPERATURE : 70°C
额定周围温度: 70°C
- 2 OPERATING TEMPERATURE RANGE: -55°C ~ +155°C
使用温度范围: -55°C ~ +155°C
- 3 FOR RESISTORS IPERATED IN AMBIENT TEMPERATURE OVER 70°C, POWER RATING SHALL BE DERATED IN ACCORDANCE WITH THE FIGURE
周围温度70°C以上使用时, 根据降功率曲线将减轻额定功率

BULK TYPE DIMENSION (TO TYPE)

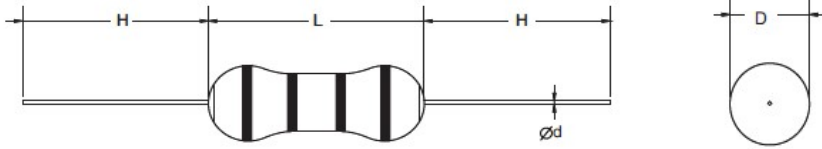

| TYPE | LEAD TYPING DIMENSION (mm) | | | |
|---------------|----------------------------|-------|---------|-------|
| | L±1.0 | D±1.0 | Φd±0.05 | H±3.0 |
| 1/8W 1/4WS | 3.7 | 2.3 | 0.43 | 26 |
| 1/4W 1/2WS | 6.2 | 2.7 | 0.43 | 26 |
| 1/2W 1WS | 9 | 3.5 | 0.53 | 26 |
| 1W 2WS | 11 | 4.5 | 0.63 | 31 |
| 2W 3WS | 15.5 | 5 | 0.73 | 31 |
| 3W 5WS | 17.5 | 6 | 0.73 | 31 |
| 5W 7WS | 25 | 8 | 0.83 | 39 |

TO TYPE

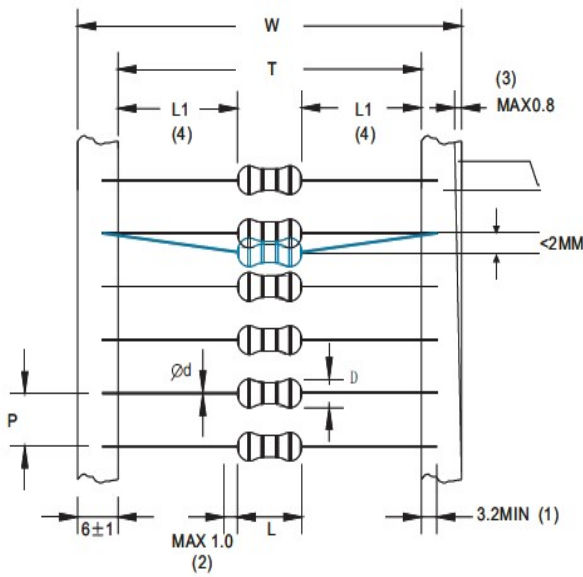

| TYPE | LEAD TYPING DIMENSION (mm) | | | | | | | |
|---------------|----------------------------|--------------|-------|---------|-------|-------|-----|--------------|
| | T | +1.5 -0.0 | D±1.0 | Φd±0.05 | P±0.3 | L±1.0 | T | +2.0 -0.0 |
| 1/8W 1/4WS | 26 | | 2.3 | 0.43 | 5 | 3.7 | 38 | |
| | 52 | | | | | | 64 | |
| 1/4W 1/2WS | 26 | | 2.7 | 0.43 | 5 | 6.2 | 38 | |
| | 52 | | | | | | 64 | |
| 1/2W 1WS | 52 | | 3.5 | 0.53 | 5 | 9 | 64 | |
| 1W 2WS | 63 | | 4.5 | 0.63 | 5 | 11 | 75 | |
| 2W 3WS | 73 | | 5 | 0.73 | 10 | 15.5 | 85 | |
| 3W 5WS | 73 | | 6 | 0.73 | 10 | 17.5 | 85 | |
| 5W 7WS | 93 | | 8 | 0.83 | 10 | 25 | 105 | |

- LEAD DIMENSIONS INCLUDED IN TAPE
纸带内缘导线长度
- LEAD PAINT DIMENSION
涂漆于导线上的长度
- DIFFERENCE OF A & B
A带与B带的位差
- [L1-L2]<1.0MM
左右边差小于1.0MM

X-ON Electronics

Largest Supplier of Electrical and Electronic Components

Click to view similar products for [Thick Film Resistors - Through Hole](#) category:

Click to view products by [Anhui VICO](#) manufacturer:

Other Similar products are found below :

[M8340104K3300GCD03](#) [M8340105K3300GGD03](#) [M8340105K3922FGD03](#) [M8340107K2401GCD03](#) [M8340109K1002JCD03](#)

[M8340109K1003GCD03](#) [MP850-3.00-1%](#) [ARC3.11 2M J A](#) [M8340105K1003GCD03](#) [M8340105M2201GCD03](#) [M8340107M7501GCD03](#)

[M8340108K2051FCD03](#) [M8340108K7501GCD03](#) [M8340108M5100JGD03](#) [M8340109K1000GCD03](#) [MOX-GRD-001](#)

[M8340102M4701GBD04](#) [M8340102K1002GBD04](#) [M8340109K2002GGD03](#) [M8340108K2002FGD03](#) [OE1305](#) [MS-221-82R5](#) [MOX-](#)

[750231004DE](#) [MOX-4-127505J](#) [SM102034504FE](#) [MOX300002206FE](#) [MOX-400233004F](#) [MOX300001005BE](#) [SM104066008J](#) [MOX-](#)

[400262008PE](#) [MOX-400232506FE](#) [MOX-400234007FE](#) [MOX-400221006G](#) [MOX-750235006ME](#) [SM103032506FE](#) [SM202022005FE](#)

[MOX1125231002FE](#) [MOX-1-122504F](#) [MOX-400225003F](#) [MOX1125731008FE](#) [MOX-5-126002JE](#) [MS176-2.20M-1%](#) [MOX-830212453BE](#)

[TRHE01A270RJ2E](#) [TRHE01A560RJ2E](#) [TRHP01A200RF2E](#) [TRHP01A5001F2E](#) [MG715-2.40M-1%](#) [MS214-20.0K-1%](#) [MF0W4FF4702A50](#)