

规格承认书

SPECIFICATION FOR APPROVAL

客户 CUSTOMER : 适用所有

品名 PRODUCT : 不燃性金属氧化膜电阻器系列



规格 TYPE : M01/4W-7WS

客户承认印
CUSTOMER APPROVED

 **东莞市粤翔电子科技有限公司**
Dong Guan City FlyWin Electronic SCI-TECH Co.,Ltd.

地址：东莞市黄江镇田心村嘉宾路25号冠亚工业园
电话：0769--86732158 传真：0769--86666888

一式二份 粤翔一份 客户一份

出图	业务	审核	核准
DRAWING	SALES	AUDITING	APPROVED
			



粤翔电子技术品质部

编号：MCS-020A

品保部 2019年12月1日



无卤
(F,Cl,Br,I)

MO SERIES

METAL OXIDE FILM RESISTORS 不燃性金属氧化膜电阻器

FLYWIN

△ FEATURES 特点

- 1 COMPLETE FLAMEPROOF CONSTRUCTION
高品质、不燃性结构涂装
- 2 GOOD RESISTIVITY TO HEAT HUMIDITY & OVERLOAD
耐热，耐湿，过负载稳定性良好
- 3 STANDARD TOLERANCE : ±5%, (±2%).
±5%, (±2%) 的标准误差
- 4 VARIETY OF PACKAGING-BULK 26mm、52mm、63mm、73mm、
93mm TAPE, CUT AND FORMED
可供散装、编带26mm、52mm、63mm、73mm、93mm、成型、剪脚
- 5 HIGH RESISTANCE RANGE (0Ω-22MΩ).
阻抗范围高 (0Ω-10MΩ).



本体



小型化

△ CONSTRUCTION 结构图

- 1 CERAMIC CORE (HIGH CONDUCTIVITY)
陶瓷棒心 (高热传导)
- 2 HIGH STABILITY FILM
高稳定性皮膜
- 3 END CAP (HIGH RELIABILITY FITTING BY ORIGINAL
CAP-PRESSING METHOD)
端帽 (卯和度信赖性高)
- 4 HIGH INSULATION AND NON-COMBUSTIBILITY OF FROG
RESIN COATING. (BULK POWER DIMMED, MINIATURIZED TO
BRICK RED)
高绝缘及不燃性之硅树脂涂料 (本体功率为灰色，小型化
为砖红色)
- 5 COLOR CODE (PER MIL & EIA STANDARDS)
色码 (符合MIL & EIA规定之标准色码带)
- 6 LEAD WIRE (TINNED COPPER, CP)
引线 (镀锡铜线、CP线)
- 7 WELDING (LONG RELIABILITY GUARANTEE)
焊接 (长期可靠性高)

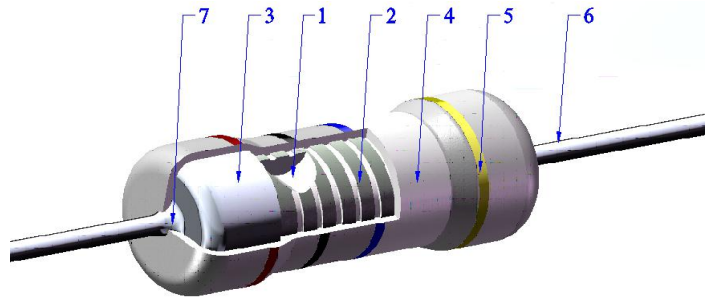

△ SPECIFICATION: 规格描述

EXAMPLE 例: MO1/4W-470KΩ ±5%-ST52

MO	1/4W	470KΩ	±5%	S	T52
品名 PRODUCT	额定功率 RATED POWER	阻值范围 RESISTANCE RANGE	误差值 TOLERANCE	线径 WIRE DIAMETER	形状 SHAPE
CR 碳膜电阻器	1/4W 1/2WS	0Ω-22MΩ	±10% K	0: 0.40CU S: 0.40CP	T26 编带26MM
MF 金膜电阻器	1/2W 1WS	阻值表示方法 RESISTANCE VALUE REPRESENTATION	±5% J	2: 0.50CU X: 0.50CP	T52 编带52MM
MO 氧化膜电阻器	1W 2WS	阻值单位按Ω, K, M	±2% G	6: 0.60CU T: 0.60CP	T63 编带63MM
MGR 高压玻璃釉电阻器	2W 3WS	1000Ω=1K 1000K=1M	±1% F	9: 0.70CU Q: 0.70CP	T73 编带73MM
KNP 绕线电阻器	3W 5WS	例: 9Ω 1/5K6/4M7	±0.5% D	A: 0.75CU D: 0.80CP	T93 编带93MM
NKNP 无感绕线电阻器	5W 7WS			C: 0.80CU	P 散装
FR 保险电阻器					M、MB、MK 卧式成型散装
FRKNP 绕线保险电阻器					FY、FKY、 FYL、FKYL 立式成型散装
SCF 高压脉冲电阻器					FT 立式成型编带

NOTE1注解: RATED VOLTAGE 额定电压 = $\sqrt{\text{POWER RATING 额定功率} \times \text{RESISTANCE VALUE 公称阻值}}$

MO SERIES

METAL OXIDE FILM RESISTORS 不燃性金属氧化膜电阻器

FLYWIN

△ PERFORMANCE 性能

CHARACTERISTICS 特性项目	SPECIFICATIONS 规格值	TEST METHODS JIS C 5202 测试方法 JIS C 5202标准															
DC RESISTANCE 直流阻抗值	J (±5%)	RESISTANCE VALUE TEST AT ROOM TEMPERATURE 25°C 阻值测试在室温25°C															
T. C. R温度系数	<table border="1"> <tr> <td>1/8W</td> <td>1/4WS</td> <td rowspan="7"> $<10\Omega \pm 400PPM$ $10\Omega - 1M \pm 350PPM$ $>1M \pm 1000PPM$ </td> </tr> <tr> <td>1/4W</td> <td>1/2WS</td> </tr> <tr> <td>1/2W</td> <td>1WS</td> </tr> <tr> <td>1W</td> <td>2WS</td> </tr> <tr> <td>2W</td> <td>3WS</td> </tr> <tr> <td>3W</td> <td>5WS</td> </tr> <tr> <td>5W</td> <td>7WS</td> </tr> </table>	1/8W	1/4WS	$<10\Omega \pm 400PPM$ $10\Omega - 1M \pm 350PPM$ $>1M \pm 1000PPM$	1/4W	1/2WS	1/2W	1WS	1W	2WS	2W	3WS	3W	5WS	5W	7WS	$\frac{R2-R1}{R1(T2-T1)} \times 10^6 PPM/^\circ C$ R1: RESISTANCE VALUE AT ROOM TEMPERATURE (T1) 常温 (T1) 阻抗值 R2: RESISTANCE VALUE AT ROOM TEMPERATURE +100°C (T2) 常温+100°C 阻抗值
1/8W	1/4WS	$<10\Omega \pm 400PPM$ $10\Omega - 1M \pm 350PPM$ $>1M \pm 1000PPM$															
1/4W	1/2WS																
1/2W	1WS																
1W	2WS																
2W	3WS																
3W	5WS																
5W	7WS																
LOAD LIFE IN HUMIDITY 湿度寿命	RESISTANCE CHANGE RATE $\pm(5\%+0.05\Omega)$ WITH NO EVIDENCE OF RESISTOR DAMAGE. 阻坑值变化率 ($5\% \pm 0.05\Omega$)，电阻器不可有损伤	RESISTANCE CHANGE AFTER 1000H (1.5H ON, 0.5H OFF) AT RATED VOLTAGE IN A HUMIDITY CHAMBER CONTROLLED AT $40\% \pm 2^\circ C$ AND 90-95% RELATIVE HUMIDITY. (when the test voltage exceeds the working voltage, considering the working voltage) 温度 $40\% \pm 2^\circ C$ ，相对湿度 90-95% 于恒温恒湿箱中，加额定直流电压测试 1.5 小时停止 0.5 小时，连续 1000 小时。（当实验电压超过最高使用电压，采用最高使用电压）															
LOAD LIFE 温度寿命	RESISTANCE CHANGE RATE $\pm(5\%+0.05\Omega)$ MAX WITH NO EVIDENCE OF RESISTOR DAMAGE. 阻坑值变化率 ($5\% \pm 0.05\Omega$)，电阻器不可有损伤	RESISTANCE CHANGE AFTER 1000H OPERATING AT RATED VOLTAGE WITH DUTY CYCLE OF 1.5H ON 0.5H OFF AT $70^\circ C \pm 2^\circ C$ (when the test voltage exceeds the working voltage, considering the working voltage) 温度 $70\% \pm 2^\circ C$ ，加额定直流电压测试 1.5 小时停止 0.5 小时，连续 1000 小时（当实验电压超过最高使用电压时，采用最高使用电压）															
SHORT TIME OVER LOAD 短时间过负荷	$\pm(1\%+0.05\Omega)$	RESISTANCE CHANGE AFTER THE APPLICATION OF A POTENTIAL OF 2.5T RATED VOLTAGE FOR 5 SE (when the test voltage exceeds the maximum overload, consider using the maximum overload voltage) 额定电压 X 2.5 倍，测试 5 秒（当实验电压超过最高过负荷电压，采用最高过负荷电压）															
PULSE OVER LOAD 断续过负荷	1/8W, 1/4W, 1/2W, 1W, 2W, 3W, 5W	$\pm(1\%+0.05\Omega)$															
	1/4WS, 1/2WS, 1WS, 2WS, 3WS, 5WS, 7WS	$\pm(2\%+0.05\Omega)$															
RESISTANCE TO SOLVENT 耐溶剂性	NO VISIBLE DAMAGES TO PROTECTIVE COATING AND MARKING (外观无异常，标识能够清楚易辨)	SOAK 3MIN IN THE MELTING AGENT TO AGAIN AND AGAIN WIPE 10 TIMES (三氯乙烯浸泡 3 分钟，再用湿布反复擦拭 10 次)															
INSULATION RESISTANCE 绝缘阻抗	$>1000M\Omega$																
ELECTRIC WITHSTANDING VOLTAGE 绝缘耐电压	RESISTANCE CHANGE RATE $\pm(1\%+0.05\Omega)$ WITH NO EVIDENCE OR RESISTOR DAMAGE. 阻坑值变化率 $\pm(1\%+0.05\Omega)$ ，电阻器不可有损伤	ELECTRIC RESISTANCE BOTH ENDS THE CONJUNCTION LINE PUT ON THE METALS V TYPE THE SLOT, ACCORDING TO THE ELECTRIC VOLTAGE PROVISION OF THE CHARACTERISTIC WATCH 60 SECONDS INFLICTION 电阻两端导线置于金属 V 型槽上，依特性表之电压规定施加 60 秒															
TEMPERATURE CYCLING 温度循环	RESISTANCE CHANGE RATE IS $\pm(1\%+0.05\Omega)$ MAX, WITH NO EVIDENCE OF RESISTOR DAMAGE. 阻坑值变化率 $\pm(1\%+0.05\Omega)$ 以内，电阻器不可有损伤	<table border="1"> <thead> <tr> <th>STEP 步骤、</th> <th>TEMPERATURE 温度</th> <th>TIME (MIN) 放置时间</th> </tr> </thead> <tbody> <tr> <td>1</td> <td>$-55^\circ C \pm 2^\circ C$</td> <td>30</td> </tr> <tr> <td>2</td> <td>ROOM TEMP 室温</td> <td>10-15</td> </tr> <tr> <td>3</td> <td>$85^\circ C \pm 2^\circ C$</td> <td>30</td> </tr> <tr> <td>4</td> <td>ROOM TEMP 室温</td> <td>10-15</td> </tr> </tbody> </table>	STEP 步骤、	TEMPERATURE 温度	TIME (MIN) 放置时间	1	$-55^\circ C \pm 2^\circ C$	30	2	ROOM TEMP 室温	10-15	3	$85^\circ C \pm 2^\circ C$	30	4	ROOM TEMP 室温	10-15
STEP 步骤、	TEMPERATURE 温度	TIME (MIN) 放置时间															
1	$-55^\circ C \pm 2^\circ C$	30															
2	ROOM TEMP 室温	10-15															
3	$85^\circ C \pm 2^\circ C$	30															
4	ROOM TEMP 室温	10-15															
RESISTANCE TO SOLDERING HEAT 耐热性	RESISTANCE CHANGE RATE IS $\pm(2\%+0.05\Omega)$ MAX, WITH NO EVIDENCE OF RESISTOR DAMAGE. 阻坑值变化率 ($2\% \pm 0.05\Omega$) 以内，电阻器不可有损伤	PUT THE LEAD LINE OF RESISTANCE INTO THE SOLDERING ABOUT 3.2 TO 4.8MM PLEASE TAKE IMPLEMENTATION ON THE BASIS OF THE TABLE BELOW 将电阻两端导线浸入锡炉约 3.2 至 4.8mm 依下表规定实施 <table border="1"> <thead> <tr> <th>TEMPERATURE 温度</th> <th>DIP TIME 放置时间</th> </tr> </thead> <tbody> <tr> <td>$350^\circ C \pm 10^\circ C$</td> <td>$3 \pm 0.5$ SEC</td> </tr> <tr> <td>$260^\circ C \pm 5^\circ C$</td> <td>$10 \pm 1.0$ SEC</td> </tr> </tbody> </table>	TEMPERATURE 温度	DIP TIME 放置时间	$350^\circ C \pm 10^\circ C$	3 ± 0.5 SEC	$260^\circ C \pm 5^\circ C$	10 ± 1.0 SEC									
TEMPERATURE 温度	DIP TIME 放置时间																
$350^\circ C \pm 10^\circ C$	3 ± 0.5 SEC																
$260^\circ C \pm 5^\circ C$	10 ± 1.0 SEC																
SOLDERABILITY 焊锡性	95% COVERAGE MINIMUM 95% 覆盖于导线上	TEST TEMPERATURE OF SOLDER: $230^\circ C \pm 5^\circ C$ DWELL TIME IN SOLDER: 3 ± 0.5 SEC 锡炉温度: $230^\circ C \pm 5^\circ C$ 浸锡时间: 3 ± 0.5 秒															
SOLDER JOINT PULL 焊点拉力	PULLING TEST FOR 1/8W $\geq 1.8KG$, 1/4W $\geq 3.8KG$, 1/2W BIGGER THAN $\geq 5KG$ 拉力强度 1/8W $\geq 1.8KG$, 1/4W $\geq 3.8KG$, 1/2W 含以上 $\geq 5KG$	SECURE BOTH LEAD WIRE ON EACH SIDE OF PULLING MACHING AND THEN PULL IT 将成品电阻铜线一端夹在拉力器的一端，铜线另一端也夹在拉力器上，再摇动拉力器															
Life & failure rate 寿命失效率	Under the rated condition Use Life $\geq 10000H$ 额定条件下使用寿命 ≥ 10000 小时	failure rate $\leq 10PPM$ 失效率 $\leq 10PPM$															

MO SERIES

METAL OXIDE FILM RESISTORS 不燃性金属氧化膜电阻器

FLYWIN

△ POWER CHARACTERISTIC 目

POWER PATED 额定功率	1/4W	1/2WS	1/2W	1WS	1W	2WS	2W	3WS	3W	5WS	5W	7WS
MAX WORKING VOLTAGE 最高使用电压	250V	300V	300V	350V	350V	400V	400V	500V	500V	500V	500V	500V
MAX OVERLOAD VOLTAGE 最高过负荷电压	400V	500V	500V	600V	600V	600V	600V	800V	800V	800V	800V	800V
MAX INTERMITTENCE OVER LOAD VOLTAGE 最高断续过负荷	400V	500V	500V	600V	600V	600V	600V	800V	800V	800V	800V	800V
ELECTRIC WITHSTANDING VOLTAGE 绝缘耐电压	250V	250V	300V	300V	350V	350V	400V	400V	500V	500V	500V	500V
RESISTANCE TOLERANCE 阻抗误差值	K (±10%) J (±5%) G (±2%) F (±1%)											
RANGE (OHM) 阻抗值范围	MIN	0.1 Ω	0.1 Ω	0.1 Ω	0.1 Ω	0.1 Ω	0.1 Ω	0.1 Ω	0.1 Ω	0.1 Ω	0.1 Ω	0.1 Ω
	MAX	10M	10M	10M	10M	10M	10M	10M	10M	10M	10M	10M

NOTE注解: 1M ohm is high risk resistance for thin film resistors.

薄膜电阻1M以上阻值为高风险阻值

△ POWER DERATING CURVE 负载衰减曲线

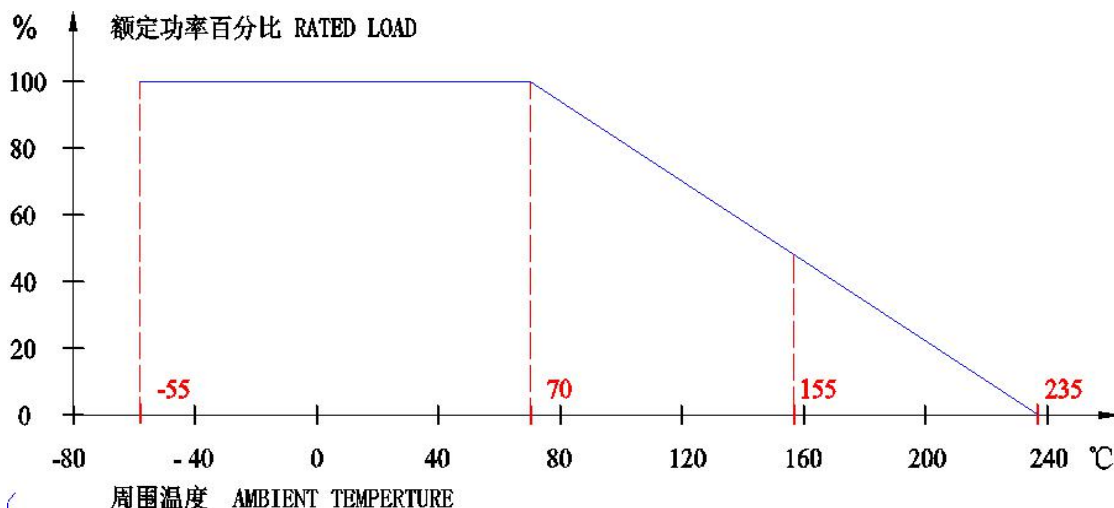

NOTE注解:

- 1 RATED AMBIENT TEMPERATURE :70°C
额定周围温度: 70°C
- 2 OPERATING TEMPERATURE RANGE:-55°C~+155°C
使用温度范围: -55°C~+155°C
- 3 FOR RESISTORS IPERATED IN AMBIENT TEMPERATURE OVER 70°C,POWER RATING SHALL BE DERATED IN ACCORDANCE WITH THE FIGURE
周围温度70°C以上使用时, 根据降功率曲线将减轻额定功率

MO SERIES

METAL OXIDE FILM RESISTORS 不燃性金属氧化膜电阻器

FLYWIN

△ TYPE DIMENSION 型号尺寸

◆ BULK TYPE 散装

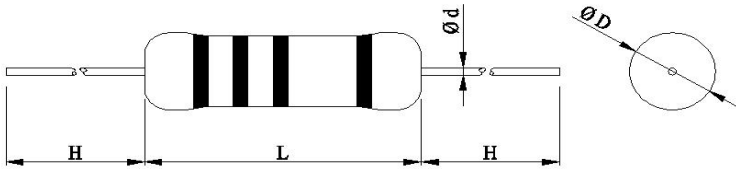

POWER 功率	DIMENSION 尺寸 (mm)			
	L±1.0	ØD±1.0	Ød±0.05	H±3.0
1/4W 1/2WS	6.2	2.7	0.40	26
1/2W 1WS	9	3.5	0.50	25
1W 2WS	11	4.5	0.60	30
2W 3WS	15	5	0.70	32
3W 5WS	17	6	0.70	31
5W 7WS	25	8	0.80	39

◆ TAPING TYPE 编带

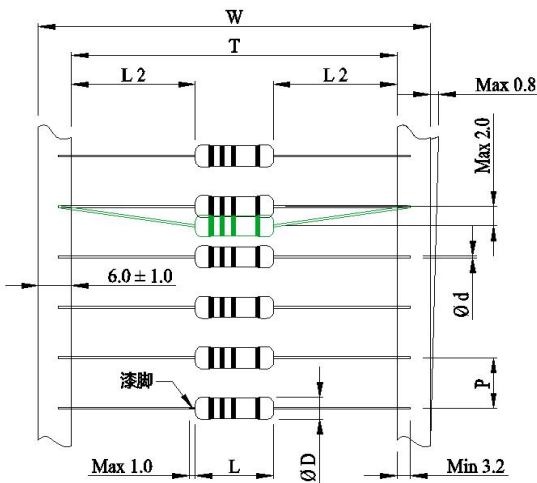

POWER 功率	DIMENSION 尺寸 (mm)						
	T	+1.5 -0.0	ØD±1.0	Ød±0.05	P±0.5	L±1.0	W
1/4W 1/2WS	26	2.7	0.40	5	6.2	38	64
	52						
1/2W 1WS	52	3.5	0.50	5	9	64	
1W 2WS	63	4.5	0.60	5	11	75	
2W 3WS	73	5	0.70	10	15	85	
3W 5WS	73	6	0.70	10	17	85	
5W 7WS	93	8	0.80	10	25	105	

MO SERIES

METAL OXIDE FILM RESISTORS 不燃性金属氧化膜电阻器

FLYWIN

◆ "M" TYPE M型

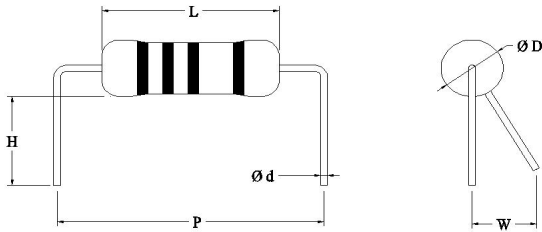

POWER 功率	DIMENSION 尺寸 (mm)					
	L±1.0	ØD±1.0	Ød±0.05	H±1.0	P±1.0	W Max
1/4W 1/2WS	6.2	2.7	0.40	3.5-10	10	3
1/2W 1WS	9	3.5	0.50	3.5-10	12.5	3
1W 2WS	11	4.5	0.60	3.5-10	15	3
2W 3WS	15	5	0.70	3.5-10	20	3
3W 5WS	17	6	0.70	3.5-10	25	3

◆ "MB" TYPE MB型

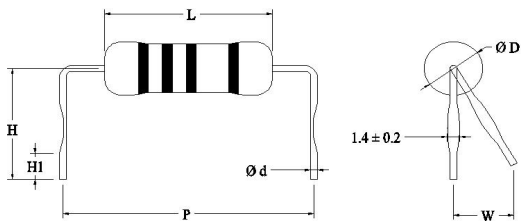

POWER 功率	DIMENSION 尺寸 (mm)						
	L±1.0	ØD±1.0	Ød±0.05	H±1.0	H1±0.5	P±1.0	W Max
1W 2WS	11	4.5	0.60	10.0-15.0	3.5	18	3
2W 3WS	15	5	0.70	10.0-15.0	3.5	20	3
3W 5WS	17	6	0.70	10.0-15.0	3.5	24	3

◆ "MK" TYPE MK型

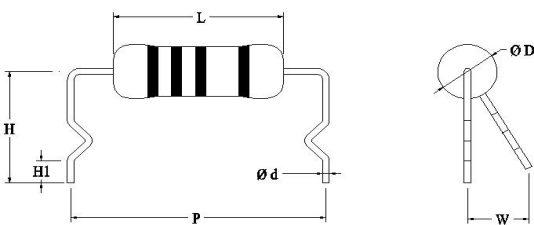

POWER 功率	DIMENSION 尺寸 (mm)						
	L±1.0	ØD±1.0	Ød±0.05	H±1.0	H1±0.5	P±1.0	W Max
1W 2WS	11	4.5	0.60	10.00	3.5	15	3
2W 3WS	15	5	0.70	10.00	3.5	20	3
3W 5WS	17	6	0.70	12.00	3.5	25	3

MO SERIES

METAL OXIDE FILM RESISTORS 不燃性金属氧化膜电阻器

FLYWIN

◆ "FY" TYPE FY型

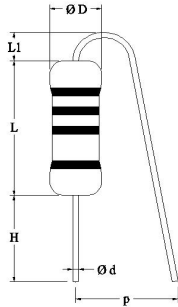

POWER 功率	DIMENSION 尺寸 (mm)					
	L±1.0	ØD±1.0	Ød±0.05	L1 Max	H±1.0	P±1.0
1/4W 1/2WS	6.2	2.7	0.40	3.5	4.00	6
1/2W 1WS	9	3.5	0.50	3.5	4.00	7
1W 2WS	11	4.5	0.60	3.5	4.00	9
2W 3WS	15.5	5	0.70	3.5	4.00	9
3W 5WS	17.5	6	0.70	3.5	4.00	9

◆ "FKY" TYPE FKY型

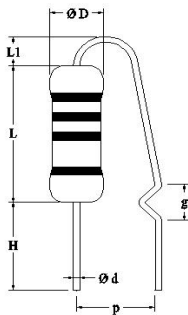

POWER 功率	DIMENSION 尺寸 (mm)						
	L±1.0	ØD±1.0	Ød±0.05	L1 Max	H±1.0	P±1.0	g±1.0
1/4W 1/2WS	6.2	2.7	0.40	3.5	4.00	6	3
1/2W 1WS	9	3.5	0.50	3.5	4.00	7	3
1W 2WS	11	4.5	0.60	3.5	4.00	9	3
2W 3WS	15.5	5	0.70	3.5	4.00	9	3
3W 5WS	17.5	6	0.70	3.5	4.00	9	3

◆ "FYL" TYPE FYL型

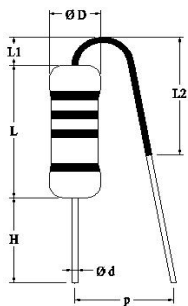

POWER 功率	DIMENSION 尺寸 (mm)						
	L±1.0	ØD±1.0	Ød±0.05	H±1.0	H1±1.0	P±1.0	L2±1.5
1/4W 1/2WS	6.2	2.7	0.40	3.5	4.00	6	7
1/2W 1WS	9	3.5	0.50	3.5	4.00	7	6
1W 2WS	11	4.5	0.60	3.5	4.00	9	9
2W 3WS	15.5	5	0.70	3.5	4.00	9	12
3W 5WS	17.5	6	0.70	3.5	4.00	9	12

◆ "FKYL" TYPE FKYL型

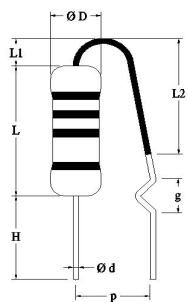

POWER 功率	DIMENSION 尺寸 (mm)							
	L±1.0	ØD±1.0	Ød±0.05	L1 Max	H±1.0	P±1.0	g±1.0	L2±1.5
1/4W 1/2WS	6.2	2.7	0.40	3.5	4.00	6	3	7
1/2W 1WS	9	3.5	0.50	3.5	4.00	7	3	6
1W 2WS	11	4.5	0.60	3.5	4.00	9	3	9
2W 3WS	15.5	5	0.70	3.5	4.00	9	3	12
3W 5WS	17.5	6	0.70	3.5	4.00	9	3	12

MO SERIES

METAL OXIDE FILM RESISTORS 不燃性金属氧化膜电阻器

FLYWIN

◆ "FT" TYPE FT型

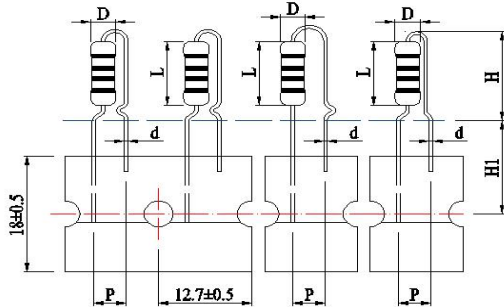

POWER 功率	DIMENSION 尺寸 (mm)					
	L±1.0	ØD±1.0	Ød±0.05	H Max	HI Max	P±0.5
1/2W 1WS	9	3.5	0.50	15.0	16.5	5
1W 2WS	11	4.5	0.60	18.0	16.5	5
2W 3WS	15.5	5	0.70	22.0	16.5	5
3W 5WS	17.5	6	0.70	22.0	16.5	5

注：以上所有成型尺寸可按照客户要求特殊定制。
All the above forming dimensions can be customized according to the customer's requirements.

△ COLOR CODE 色码

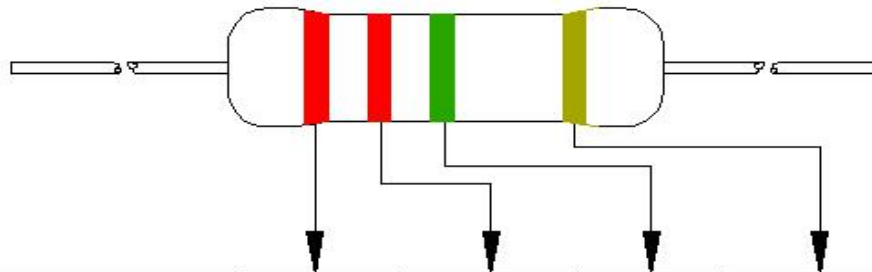

COLOR 颜色	NO. 1 第一数字	NO. 2 第二数字	NO. 3 倍率	NO. 4 允许误差
BLACK (黑)	0	0	10 ⁰	
BROWN (棕)	1	1	10 ¹	± 1% (F)
RED (红)	2	2	10 ²	± 2% (G)
ORANGE (橙)	3	3	10 ³	
YELLOW (黄)	4	4	10 ⁴	
GREEN (绿)	5	5	10 ⁵	
BLUE (蓝)	6	6	10 ⁶	
VIOLET (紫)	7	7	10 ⁷	
GRAY (灰)	8	8	10 ⁸	
WHITE (白)	9	9	10 ⁹	
GOLD (金)			10 ⁻¹	± 5% (J)
SILVER (银)			10 ⁻²	± 10% (I)

MO SERIES

METAL OXIDE FILM RESISTORS 不燃性金属氧化膜电阻器

FLYWIN

△ PACKAG 包装

◆ TAPING TYPE 编带

POWER 功率	SHAPE 形状	MPQ (KPCS) 最小包装量	QTY-BOX (KPCS) 单盒数量	QTY-CARTON (KPCS) 单箱数量
1/4W 1/2WS	T26	5.00	5.00	105.00
	T52	5.00	5.00	105.00
1/2W 1WS	T52	2.00	2.00	30.00
1W 2WS	T63	1.00	1.00	15.00
2W 3WS	T73	1.00	1.00	12.00
3W 5WS	T73	0.50	0.50	6.00
5W 7WS	T93	0.25	0.25	2.50

◆ VERTICAL TAPING TYPE 立式编带

POWER 功率	SHAPE 形状	MPQ (KPCS) 最小包装量	QTY-BOX (KPCS) 单盒数量	QTY-CARTON (KPCS) 单箱数量
1/2W 1WS	FT	3.50	3.50	35.00
1W 2WS	FT	2.50	2.50	25.00
2W 3WS	FT	2.00	2.00	20.00
3W 5WS	FT	1.80	1.80	18.00

◆ BULK TYPE 散装

POWER 功率	SHAPE 形状	MPQ (KPCS) 最小包装量	QTY-BOX (KPCS) 单盒数量	QTY-CARTON (KPCS) 单箱数量
1/4W 1/2WS	P	1.00	10.00	60.00
	FY、FKY、FYL、FKYL、M	2.00	20.00	120.00
1/2W 1WS	P	0.50	5.00	18.00
	FY、FKY、FYL、FKYL、M	1.00	5.00	30.00
1W 2WS	P	0.20	2.00	12.00
	FY、FKY、FYL、FKYL、M、MB、MK	0.50	3.00	18.00
2W 3WS	P	0.20	2.00	12.00
	FY、FKY、FYL、FKYL、M、MB、MK	0.20	2.00	12.00
3W 5WS	P	0.10	1.00	6.00
	FY、FKY、FYL、FKYL、M、MB、MK	0.20	1.00	6.00

注：

建议储存环境：温度：0-30℃且相对湿度低于65%，高温、灰层和有害气体（如酸碱性气体）都需要避免避免接触。

X-ON Electronics

Largest Supplier of Electrical and Electronic Components

Click to view similar products for [Thick Film Resistors - Through Hole](#) category:

Click to view products by [Anhui VICO](#) manufacturer:

Other Similar products are found below :

[M8340104K3300GCD03](#) [M8340105K3300GGD03](#) [M8340105K3922FGD03](#) [M8340107K2401GCD03](#) [M8340109K1002JCD03](#)

[M8340109K1003GCD03](#) [MP850-3.00-1%](#) [ARC3.11 2M J A](#) [M8340105K1003GCD03](#) [M8340105M2201GCD03](#) [M8340107M7501GCD03](#)

[M8340108K2051FCD03](#) [M8340108K7501GCD03](#) [M8340108M5100JGD03](#) [M8340109K1000GCD03](#) [MOX-GRD-001](#)

[M8340102M4701GBD04](#) [M8340102K1002GBD04](#) [M8340109K2002GGD03](#) [M8340108K2002FGD03](#) [OE1305](#) [MS-221-82R5](#) [MOX-](#)

[750231004DE](#) [MOX-4-127505J](#) [SM102034504FE](#) [MOX300002206FE](#) [MOX-400233004F](#) [MOX300001005BE](#) [SM104066008J](#) [MOX-](#)

[400262008PE](#) [MOX-400232506FE](#) [MOX-400234007FE](#) [MOX-400221006G](#) [MOX-750235006ME](#) [SM103032506FE](#) [SM202022005FE](#)

[MOX1125231002FE](#) [MOX-1-122504F](#) [MOX-400225003F](#) [MOX1125731008FE](#) [MOX-5-126002JE](#) [MS176-2.20M-1%](#) [MOX-830212453BE](#)

[TRHE01A270RJ2E](#) [TRHE01A560RJ2E](#) [TRHP01A200RF2E](#) [TRHP01A5001F2E](#) [MG715-2.40M-1%](#) [MS214-20.0K-1%](#) [MF0W4FF4702A50](#)