

Rubra Penta-band SMD Antenna

Part No. A10393

gigaNOVA®

Product Specification

1 Features

- GSM/UMTS antenna supporting up to 5 frequency bands
- Patented MDA antenna technology provides resistance to de-tuning
- High efficiency
- Easy to integrate
- Intended for SMD mounting
- Supplied in tape on reel

Rubra supports the following communication standards:

GSM/GPRS/EDGE	CDMA2000 1XRTT/EV-DO/EV-DV	UMTS WCDMA/HSPA	Other Standards
GSM850 (E)GSM900 GSM1800 (DCS) GSM1900 (PCS)	Band Classes: 1,2,3,4,6,8,9,12,14,15	Bands I – VI Bands VIII – X	Korean PCS DECT TD-SCDMA AWS

2 Description

Rubra uses a ground plane in order to radiate efficiently, but this ground plane must not extend underneath the antenna itself.

The antenna uses a matching circuit to achieve optimized results for the specific frequency bands that are required. This product specification shows the performance of the antenna when optimized to cover a typical penta-band reception: GSM850/900/1800/1900 and WCDMA.

3 Applications

- Mobile handsets
- Femto / Pico base stations
- Tracker devices
- Machine to machine communication
- Remote monitoring



4 Part number

Rubra: A10393



5 General data

Product Name	Rubra GSM SMD
Part Number	A10393
Frequency	824 – 960 MHz 1710 – 2170 MHz
Polarization	Linear
Operating Temperature	-40 °C to +85 °C
Impedance with Matching	50 Ω
Weight	2.5 g
Antenna Type	SMD
Dimensions	40 x 10.4 x 3.2 [mm]
Material	Halogen-free FR4

6 Electrical characteristics

	Typical performance	Conditions
Peak gain	1.8dBi @ 830 MHz 3.8dBi @ 1980 MHz	All data measured on Antenna's reference board, part number A10393-U1 Data given for the 824MHz-960MHz and 1710MHz-2170MHz frequency ranges
Average gain (Linear)	-1.2dBi 824-960 MHz -1.8dBi 1710-2170 MHz	
Average efficiency 824-960 MHz 1710-217 MHz	75% 65%	
Maximum Return Loss	-6 dB	
Maximum VSWR	2.6:1	

7 Electrical performance

7-1 Return Loss

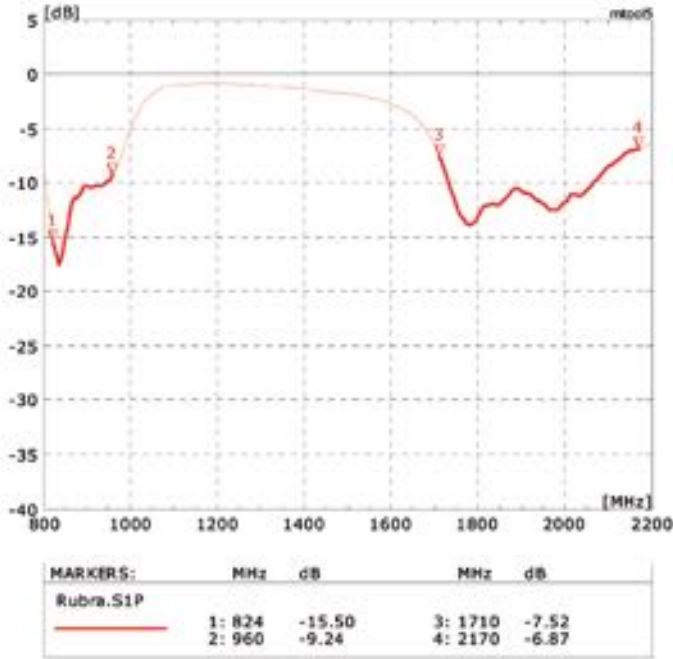

7-2 VSWR

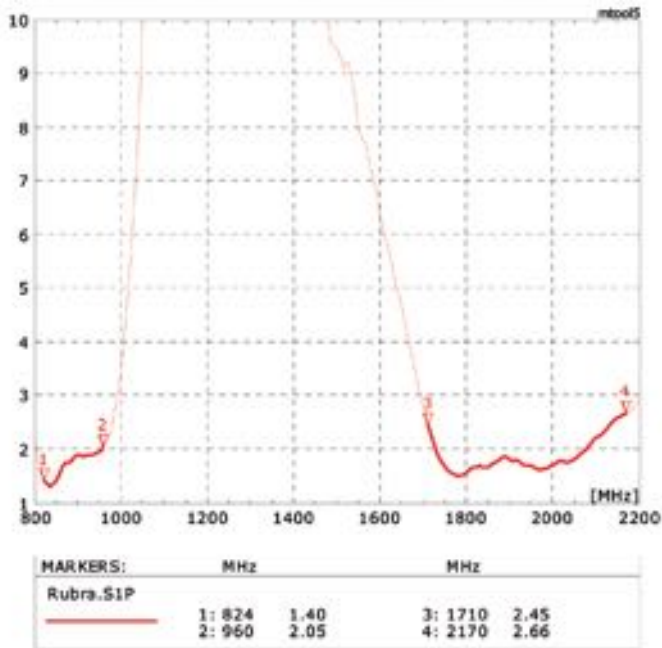

7-3 Antenna patterns 824-960 MHz

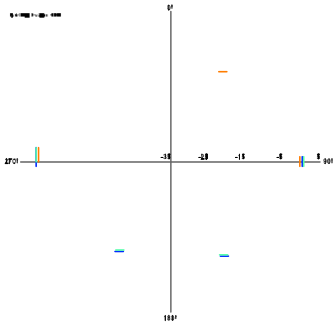
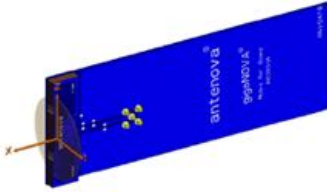
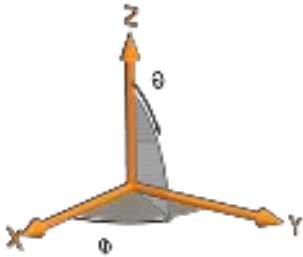
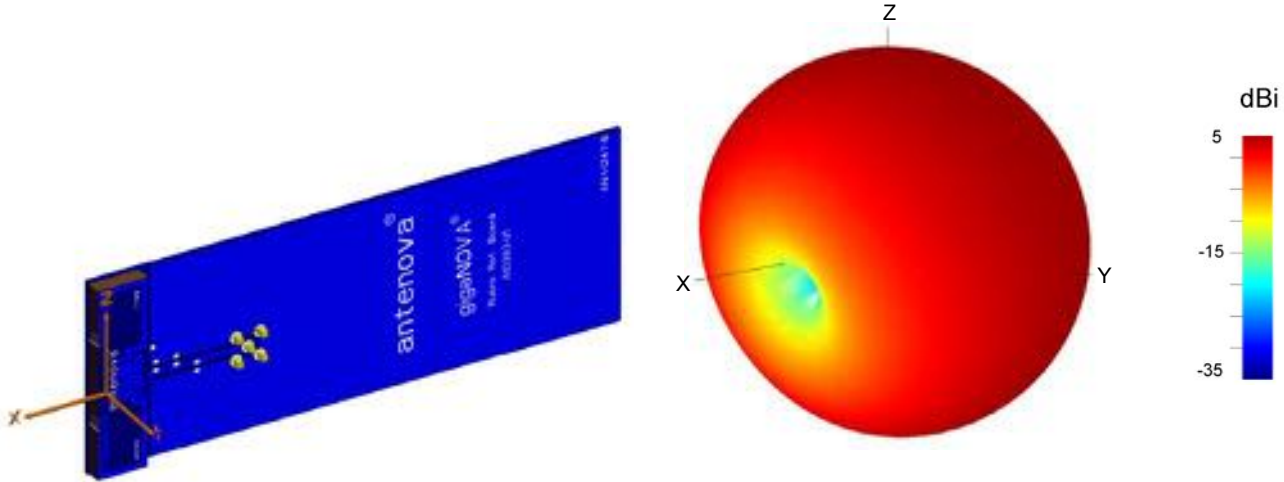

XY plane

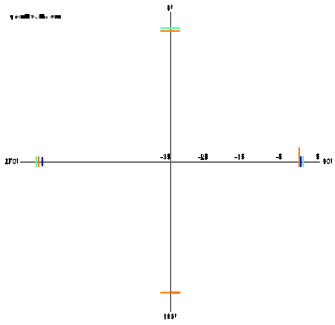

YZ plane

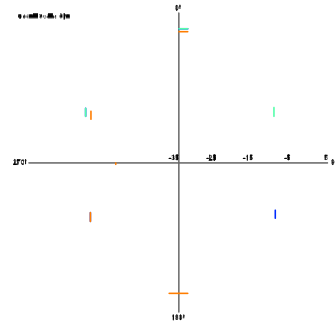

XZ plane

Patterns show combined polarisations measured on reference board A10393-U1. 3D Pattern measured at 890MHz

7-4 Antenna patterns 1710 – 2170 MHz

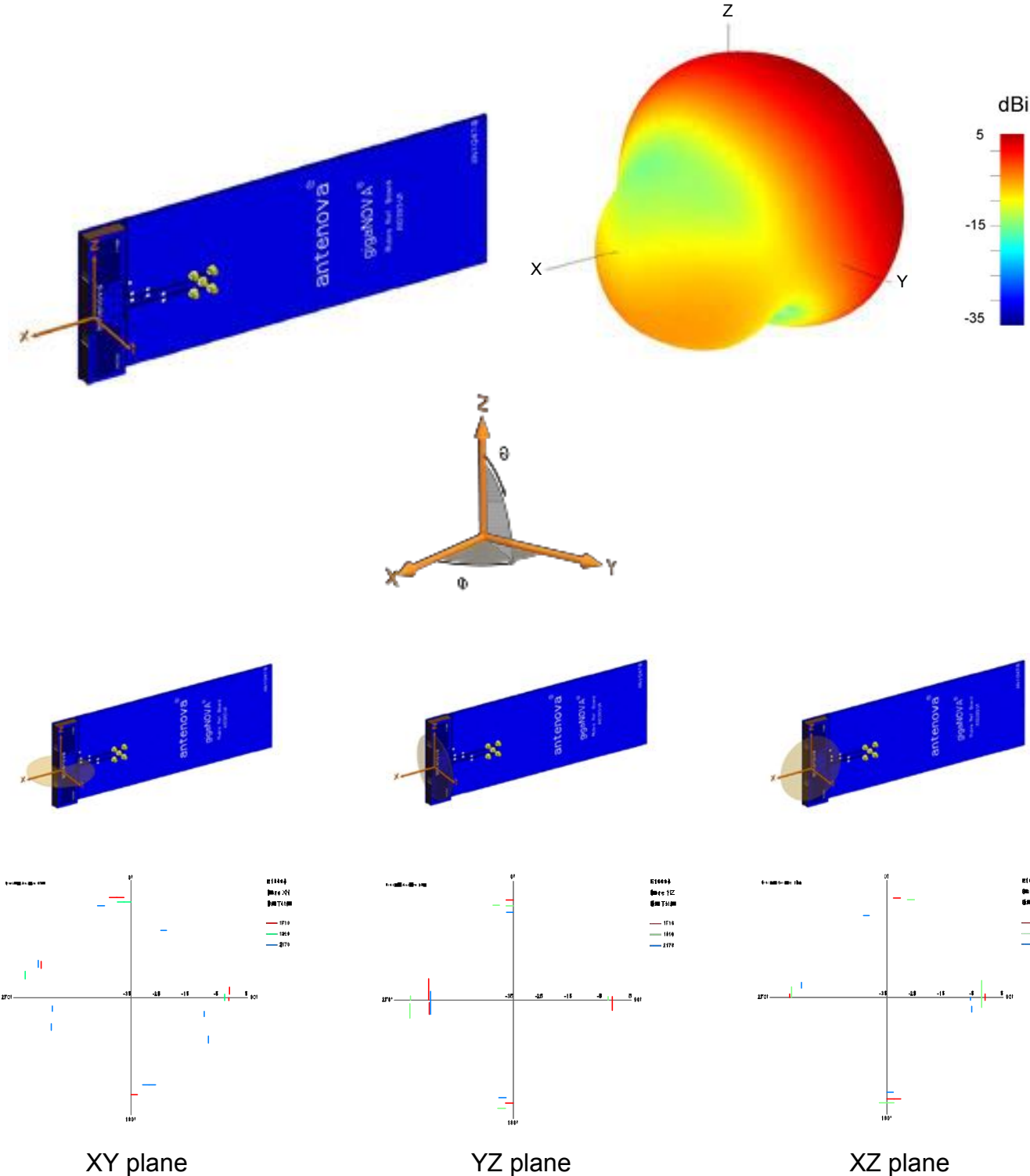

Patterns show combined polarisations measured on reference board A10393-U1. 3D Pattern measured at 1894MHz

8 Antenna efficiency

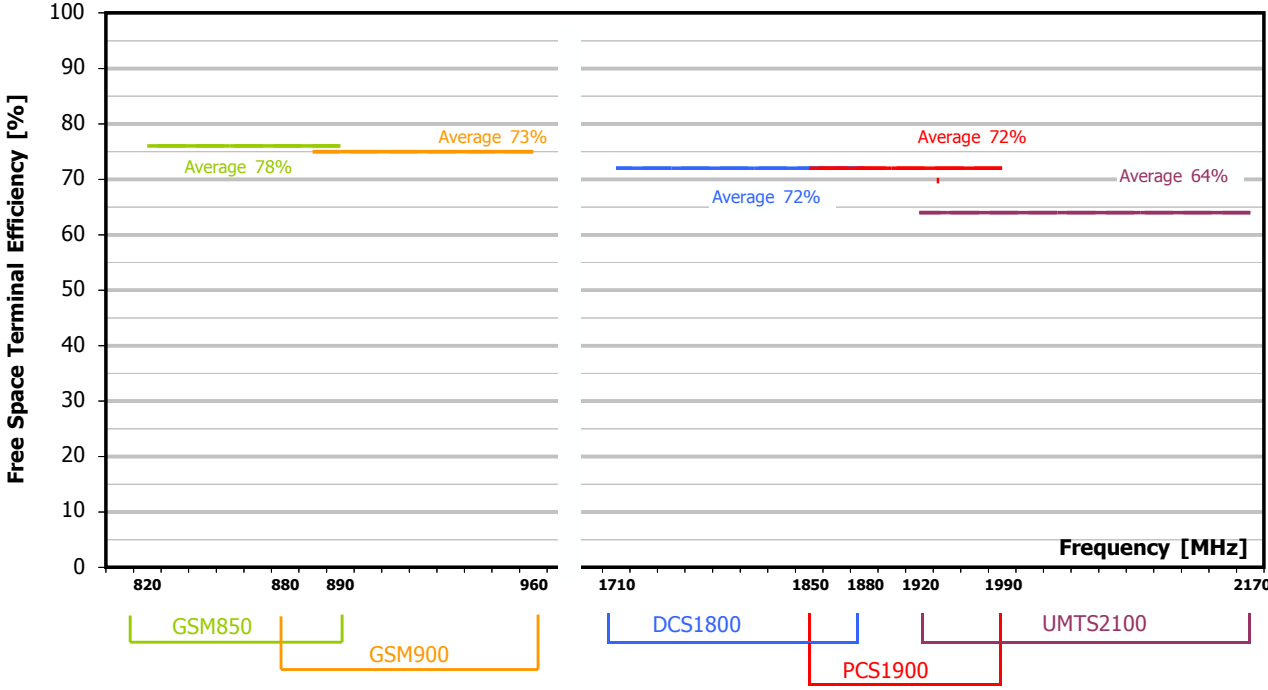

9 Antenna dimensions

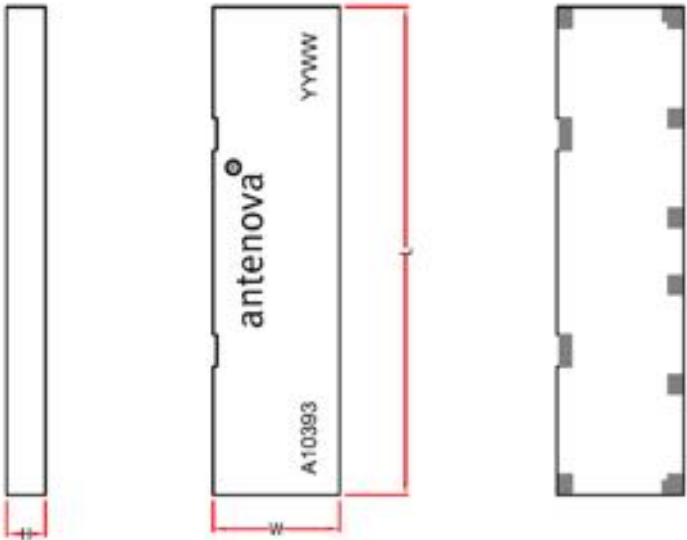

L	W	H
Length	Width	Height
40.0 +/- 0.2	10.4 +/-0.2	3.2 +/- 0.15

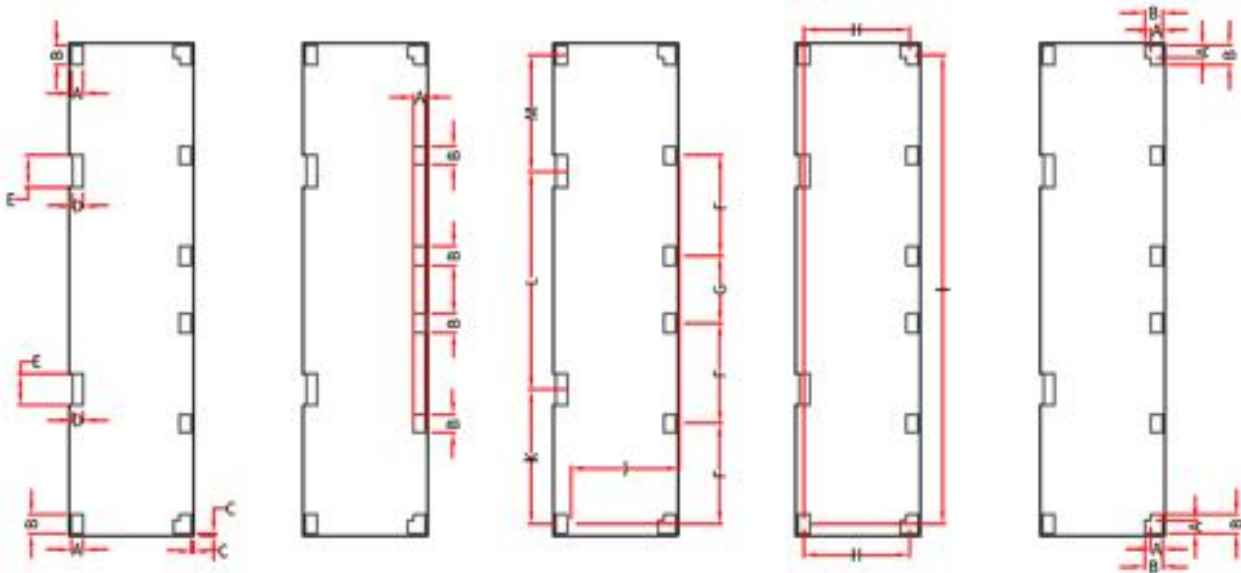

A	B	C	D	E	F	G	H	I	J	K	L	M
1.0 +/- 0.15	1.5 +/- 0.15	0.2 +/- 0.15	0.9 +/- 0.15	2.6 +/- 0.15	8.15 +/- 0.15	5.49 +/- 0.15	8.76 +/- 0.15	38.10 +/- 0.15	9.0 +/- 0.15	10.91 +/- 0.15	17.72 +/- 0.15	9.47 +/- 0.15

Dimensions in mm

10 Antenna footprint

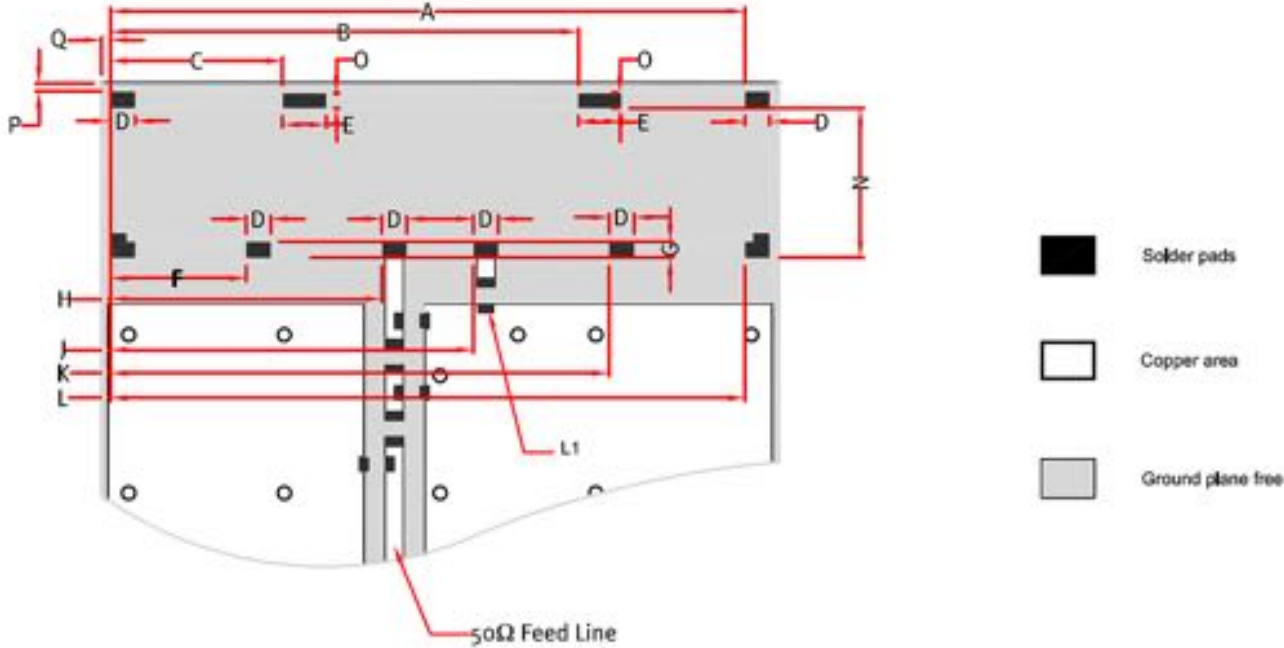

Rubra GSM (Part No: A10393)

CAD files of the antenna footprint are available to download from www.antenova-m2m.com.

A	B	C	D	E	F	G	H
38.1 +/- 0.15	28.08 +/- 0.15	10.36 +/- 0.15	1.5 +/- 0.15	2.6 +/- 0.15	8.15 +/- 0.15	1.00 +/- 0.15	16.3 +/- 0.15
I	J	K	L	N	O	P	Q
17.07 +/- 0.15	21.8 +/- 0.15	29.95 +/- 0.15	38.10 +/- 0.15	9.00 +/- 0.15	0.89 +/- 0.15	0.50 +/- 0.15	0.50 +/- 0.15

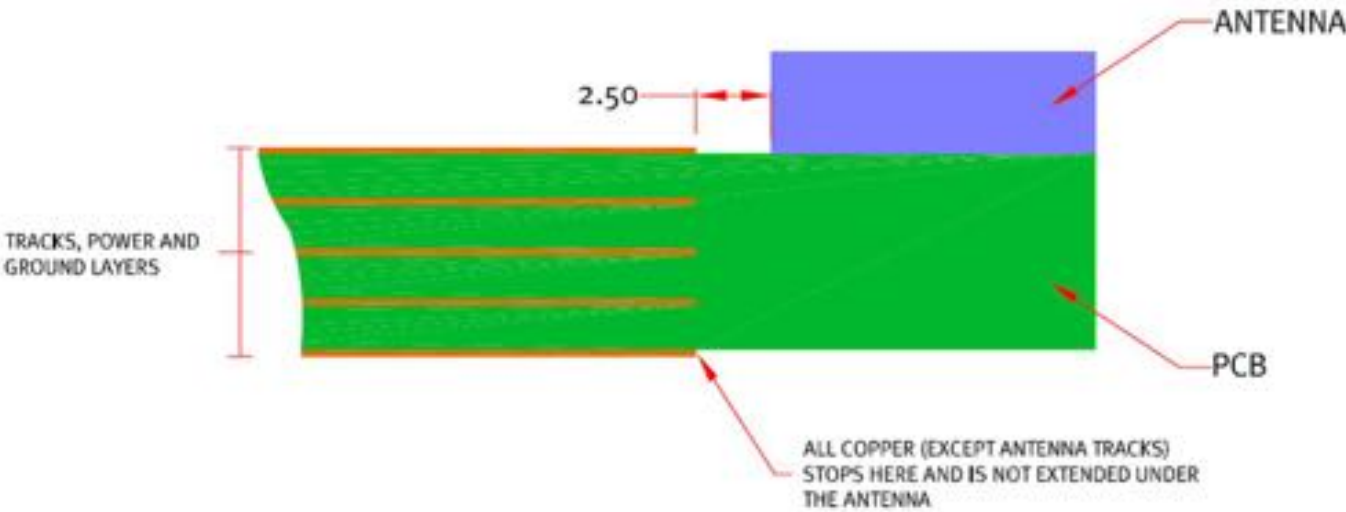
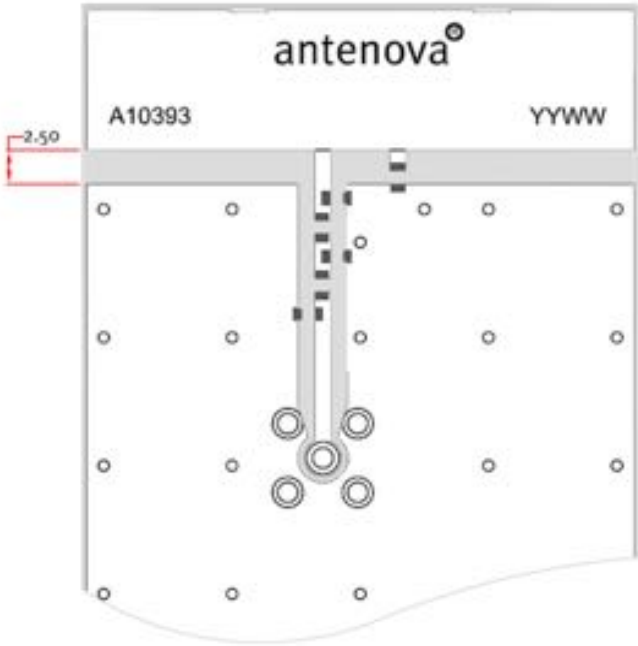

Rubra GSM (Part No: A10393)

CAD files of the antenna footprint are available to download from www.antenna-m2m.com.

11 Electrical interface

11-1 Transmission lines

The antenna should be connected using an RF transmission line.

All transmission lines should be designed to have a characteristic impedance of 50 Ω . The length of the transmission lines should be kept to a minimum. Any other parts of the RF system like transceivers, power amplifiers, etc, should also be designed to have an impedance of 50 Ω .

Once the material for the PCB has been chosen (PCB thickness and dielectric constant), a co-planar transmission line can easily be designed using any of the commercial software packages for transmission line design. For the chosen PCB thickness, copper thickness and substrate dielectric constant, the program will calculate the appropriate transmission line width and gaps on either side of the track so the characteristic impedance of the co-planar transmission line is 50 Ω .

11-2 Matching circuit

The A10393 antenna requires an impedance matching circuit that must be optimized for each customer's product. The matching circuit will typically require 3 matching components, and up to five components depending on the impedance of the antenna when situated in the device. It is recommended that all the components in the reference schematic (Figure 1) are included in the layout. Moreover, the antenna requires an additional inductor L1 on the return pin, which is used to adjust the resonant frequency in the low band (see below).

Important: The position of the antenna feed and return pads are fixed for this product and the positions cannot be swapped over. Please check the reference layout for the relative position.

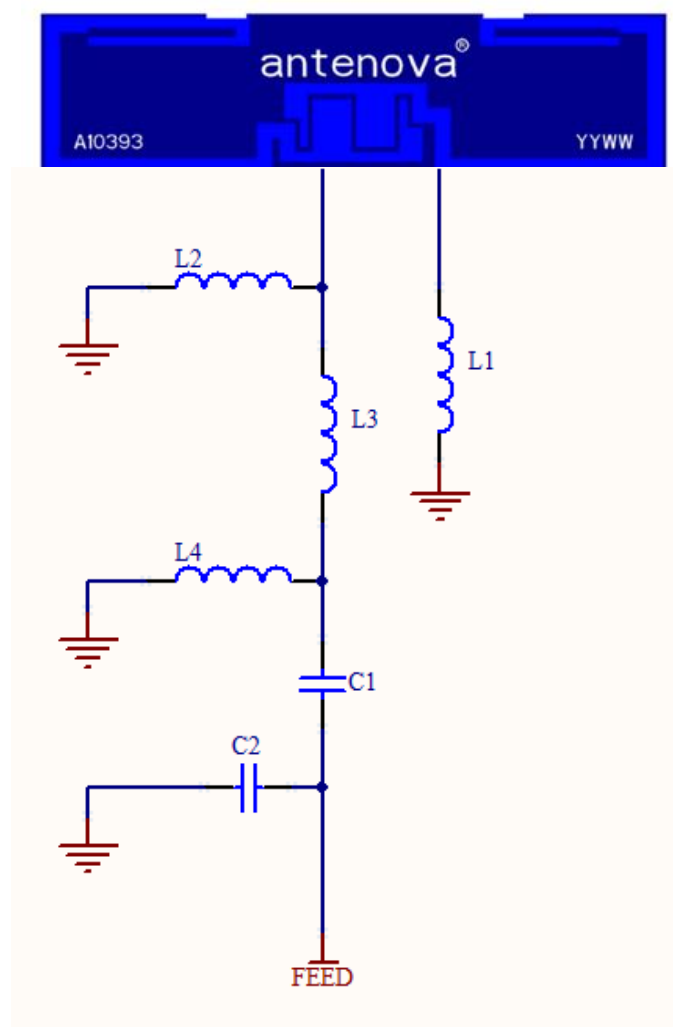

Figure 1

The values of the matching component given in the below table are for the A10393-U1 reference boards and might be different on a customer host board.

Designator	Value	Tolerance	Size	Manufacturer	PN
L1	0 Ω		0603		
L2	-		0603		Not Fitted
L3	3.3nH	± 0.3 nH	0603	MURATA	LQG18HN3N3S00
L4	10nH	$\pm 5\%$	0603	MURATA	LQG18HN10NJ00
C1	2.2pF	± 0.1 pF	0603	AVX	06035U2R2B2A
C2	33pF	$\pm 5\%$	0603		Not Fitted
Notes:					
<ul style="list-style-type: none"> For space saving purposes, components L1, L3, C1 and C2 can be replaced with equivalent components in 0402 size. It is recommended to keep L2 & L4 in 0603 size; alternatively, if size is reduced to 0402 it is recommended to use high-Q, wire-wound inductors (e.g. Murata LQW15 series). 					

Note: The component values for the matching circuit will vary depending on the size of the PCB and surrounding components. The impedance of the antenna should be measured before selecting suitable matching components. Antenova offers a matching service on request. Contact info@antenova.com for further information

Antenna frequency adjustment

The resonant frequency of the antenna can be adjusted to compensate small detuning caused by nearby objects like a plastic case or a large metal component. The adjustment mostly affects the low-band resonance [824-960MHz], with a lesser effect on the upper frequency band [1710-2170Hz].

The adjustment in the resonant frequency is achieved by changing the value of the L1 component on the grounding connection of the antenna:

- Default L1 component is a 0 Ω jumper (R0)
- If an inductor is used as L1, the low-band resonant frequency reduces as the value of the inductor increases, as shown on the right hand side of Figure 2.
- If a capacitor is used as L1, the low-band resonant frequency increases as the value of the capacitor is reduced, as shown on the left hand side of Figure 2.

Figure 2 graphically shows the relation between the type and value of the L1 component and the variation in the low-band resonant frequency. Notice that the scale of the component's values is not linear.

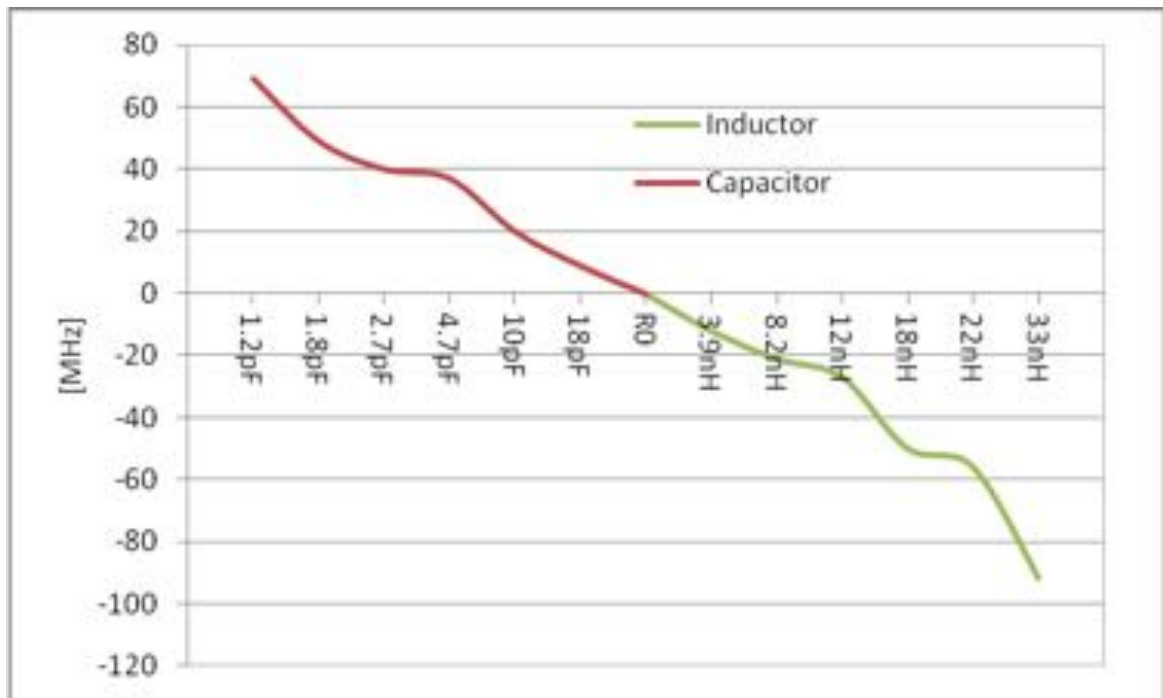

Figure 1 Frequency shift depending on the component type and value

The plot is used as an example:

- If $L1 = 8.2\text{nH}$ the resonant frequency in the low-band is about 20MHz lower than when $L1 = R0$.
- If $L1 = 10\text{pF}$ the resonant frequency in the low-band is about 20MHz higher than when $L1 = R0$.

11-3 Antenna placement

Rubra should be fitted to the device so that power from the antenna can radiate into free space. Antenova strongly recommends placing the antenna near the edge of the board. Maximum antenna performance is achieved by placing the antenna close to the corner of the PCB with few components or metal objects nearby. The antenna requires a ground free area below the antenna on all PCB layers. Ground can be placed at the side of the antenna with a clearance of >10mm from each side recommended, including free from components or conducting objects. The placements shown here are for guidance only, as the actual performance differences will depend on each individual device.

Antenova M2M offers a full range of development support to ensure efficient implementation of the antenna into the specific design. To overcome RF design issues, matching circuits, transmission lines, layout and other components, please contact Antenova M2M (sales@antenova-m2m.com) for design and placement recommendations.

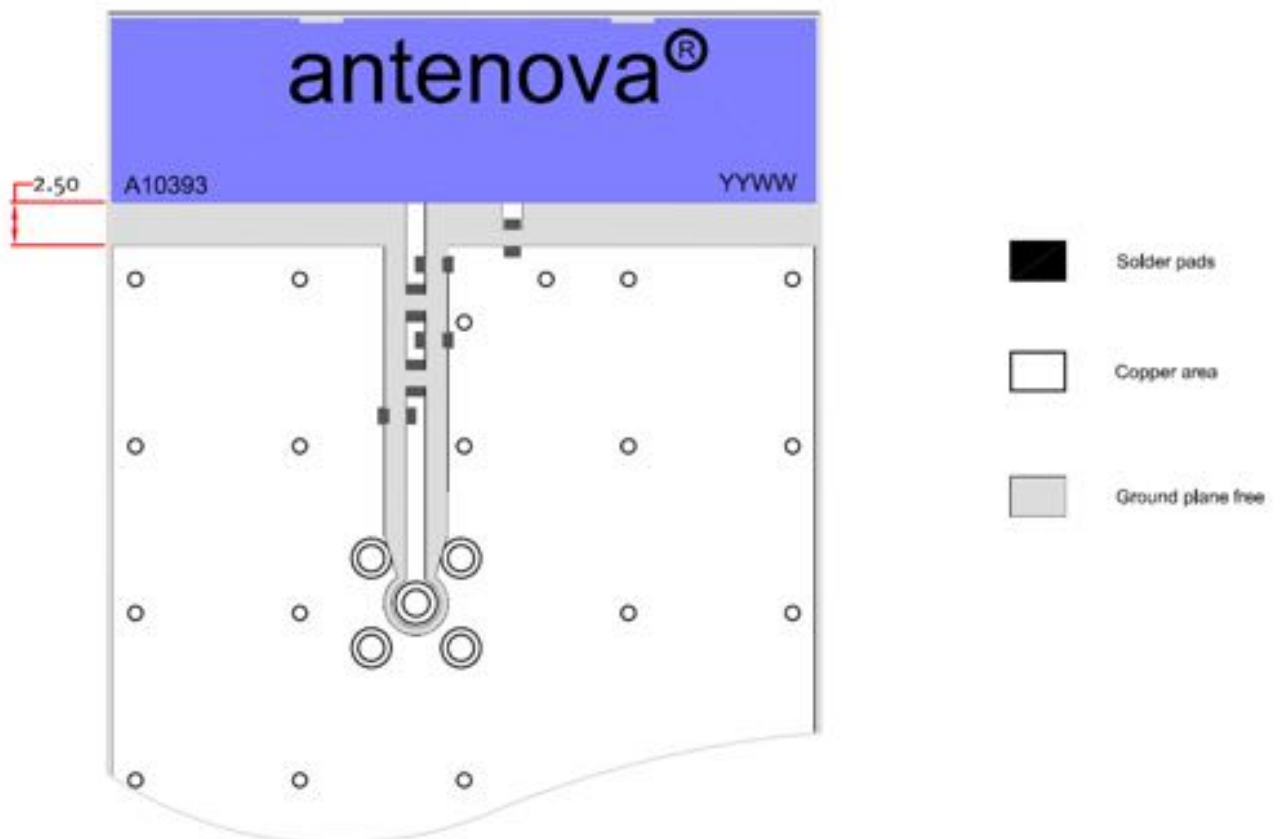

Antenna Placement and recommended ground plane free clearance area

11-4 Reference boards

The reference board has been designed for evaluation purposes of Rubra GSM antenna and it includes a SMA female connector. The reference board is available with Rubra tuned to cover 5 bands: GSM850/900/1800/1900 and WCDMA, Part number: A10393-U1

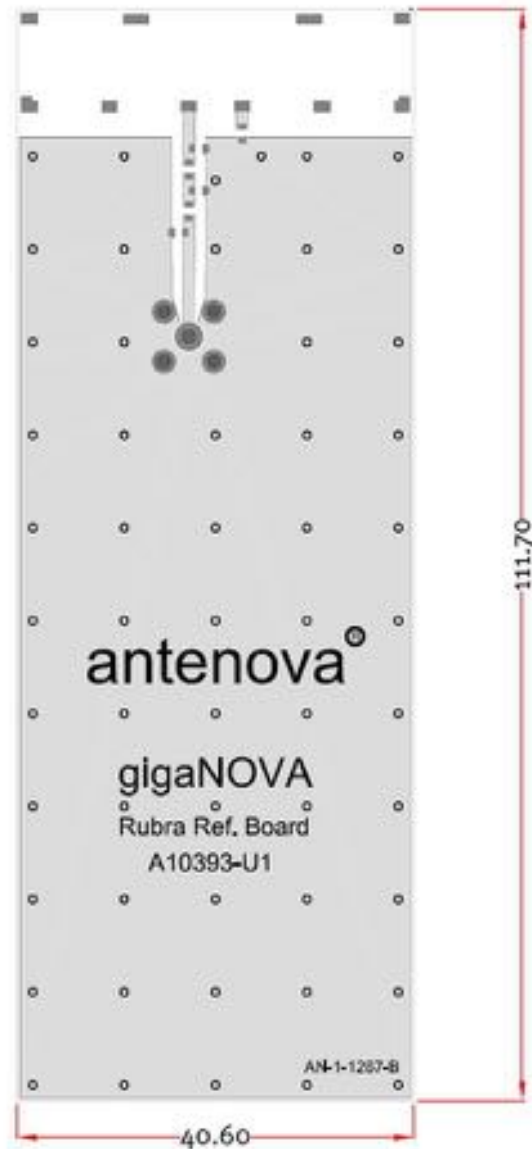

Dimensions in mm

Note: Other size reference boards are available for typical applications. Contact sales@antenna-m2m.com for further information or to order a reference board.

12 Soldering

This antenna is suitable for lead free soldering.

The reflow profile should be adjusted to suit the PCBA, oven and solder paste, while observing the following conditions:

- The maximum temperature should not exceed 240 °C
- However for lead free soldering, a maximum temperature of 255 °C for no more than 20 seconds is permitted.
- The antenna should not be exposed to temperatures exceeding 120 °C more than 3 times during the soldering process.

13 Hazardous material regulation conformance

The antenna has been tested to conform to RoHS requirements. A certificate of conformance is available from Antenova M2M's website.

14 Packaging

14-1 Optimal storage conditions for packaged reels

Temperature	-10°C to 40°C
Humidity	Less than 75% RH
Shelf Life	18 Months
Storage place	Away from corrosive gas and direct sunlight
Packaging	Reels should be stored in unopened sealed manufacturer's plastic packaging.

Note: Storage of open reels of antennas is not recommended due to possible oxidization of pads on antennas. If short term storage is necessary, then it is highly recommended that the bag containing the antenna reel is re-sealed and stored in like storage conditions as in above table.

14-2 Tape characteristics

Rubra

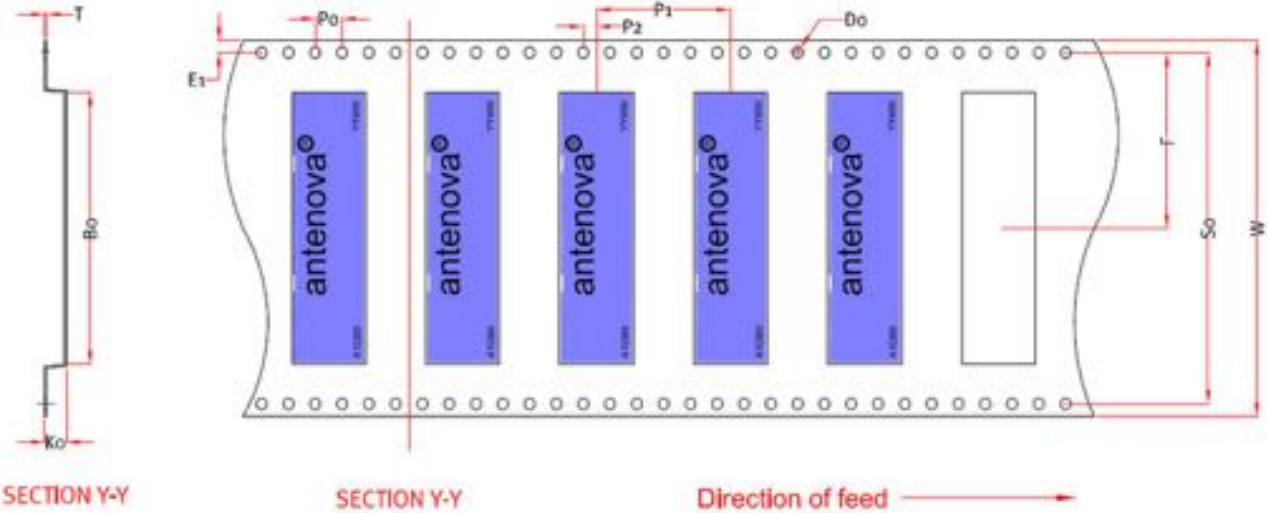

W	F	E1	P0	P1	P2	A0	B0	K0	SO	T	D0
56 ± 0.2	26.2 ± 0.1	1.75 ± 0.1	4 ± 0.1	20 ± 0.1	2 ± 0.1	9.3 ± 0.1	40.6 ± 0.1	3.2 ± 0.1	52.4 ± 0.1	0.3 ± 0.05	Min 1.5 +/- 0.1

Dimensions in mm

Quantity	Leading Space	Trailing Space
1000 pcs / reel	50 blank antenna holders	50 blank antenna holders

14-3 Reel dimensions

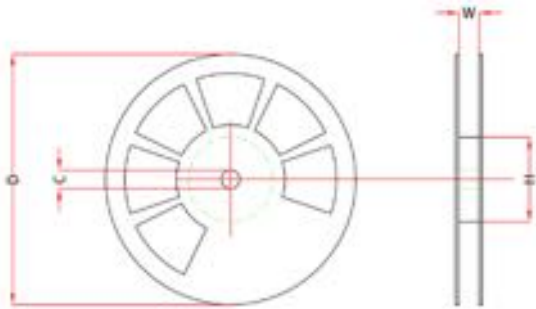

Width	Reel Diameter	Hub Diameter	Shaft Diameter
57.5 mm	330 ± 2.0 mm	80 mm	13 ± 0.5 mm

14-4 Box dimensions

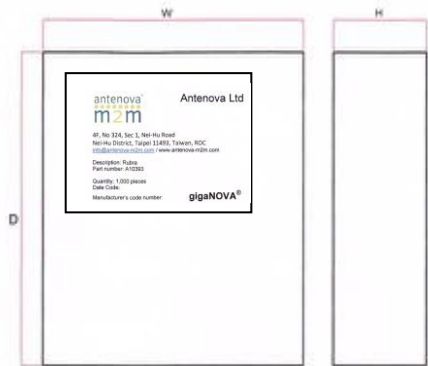

Width (W)	Breadth (B)	Thickness (H)
375 mm	355 mm	70 mm

14-5 Bag properties

Reels are supplied in protective plastic packaging.

14-6 Reel label information

Rubra



Dimensions in mm



www.antenova-m2m.com

Corporate Headquarters

Antenova Ltd.
2nd Floor, Titan Court
3 Bishop Square
Hatfield
AL10 9NA

North America Headquarters

Antenova Ltd.
100 Brush Creek Road, Suite 103
Santa Rosa
California, 95404
USA

Asia Headquarters

Antenova Asia Ltd.
4F, No. 324, Sec. 1, Nei-Hu Road
Nei-Hu District
Taipei 11493
Taiwan, ROC

Tel: +44 1223 810600
Email: sales@antenova-m2m.com

Tel: +1 707 890 5202
Email: sales@antenova-m2m.com

Tel: +886 (0) 2 8797 8630
Fax: +886 (0) 2 8797 6890
Email: sales@antenova-m2m.com

Copyright® Antenova Ltd. All Rights Reserved. Antenova®, Antenova M2M®, gigaNOVA®, the Antenova product family names and the Antenova and Antenova M2M logos are trademarks and/or registered trademarks of Antenova Ltd. Any other names and/or trademarks belong to their respective companies.

The materials provided herein are believed to be reliable and correct at the time of print. Antenova does not warrant the accuracy or completeness of the information, text, graphics or other items contained within these information. Antenova further assumes no responsibility for the use of this information, and all such information shall be entirely at the user's risk.



Certificate No: 4598

Antennas for Wireless M2M Applications

X-ON Electronics

Largest Supplier of Electrical and Electronic Components

Click to view similar products for [Antenna Development Tools](#) category:

Click to view products by [Antenova](#) manufacturer:

Other Similar products are found below :

[0868AT43A0020-EB1SMA](#) [EVALBGSA141MN10TOBO1](#) [A10393-U1](#) [PCSD.06.A](#) [B5771-U1](#) [KIT-LTE-GNSS-01](#) [KIT-WIFI-ISM-01](#)
[A10472-U1](#) [REFLECTOR-EVB-1](#) [A10340-U1](#) [ACAG0201-2450-EVB](#) [ACAG0301-15752450-EVB](#) [ACAG0301-1575-EVB](#) [ACAG0301-24505500-EVB](#) [ACAG0301-5500-EVB](#) [ACAG0801-2450-EVB](#) [ACAG1204-433-EVB](#) [ACAG1204-868-EVB](#) [ACAG1204-915-EVB](#)
[ACAR0301-SW2-EVB](#) [ACAR3005-C2WB-EVB](#) [ACAR3005-S824-EVB](#) [ACAR3705-S698-EVB](#) [ACAR4008-S698-EVB](#) [A10137-D](#)
[A10194-U1](#) [A10204-U1](#) [A5645H-EVB-1](#) [A5645-U1](#) [A5887H-EVB-1](#) [A6111-U1](#) [M20057-EVB-1](#) [SR42W001-U1](#) [SR42W009-U1](#)
[SR4G013-U1](#) [SR4G053-EVB-1](#) [SR4L034-EVB-3](#) [SR4L049-EVB-1](#) [SRC5G027-U1](#) [SRCW004-U1](#) [1001312-01](#) [M310220-01](#) [M620720-01](#)
[M830120-01](#) [M830520-01](#) [EB_NN01-105A](#) [EB_NN02-201-5G](#) [CCKLTE450-NA](#) [AEK-GNCP-TH258L15](#) [MPA-104- KIT](#)