

Features

- Simple drop in solution full GNSS receiver (GPS/GLONASS/GALILEO/BEIDOU)
- MediaTek MT3333 Flash chip
- Ultra-small SMD package; 13.8 x 9.5 x 1.8mm
- Low current consumption
- AIC, Active Interference Cancellation
- EASY - Internally generated orbit prediction for fast fix times.

Description

A compact GPS module receiver using the MediaTek MT3333 flash chip providing a complete GNSS receiver for optimum performance. The module can run three GNSS systems simultaneously to enhance location and TTFF considerably. The M20050 operates on a versatile 2.8V-4.2V supply with low power consumption and several low power modes for further power savings. An accurate 0.5ppm TXCO ensures short TTFF. Indoor and outdoor multi-path detection and compensation.

Applications

- Wearable devices
- Portable devices
- Asset tracking / personal safety
- Sports cameras / equipment
- Smart watches
- Navigation devices



Part number

M20050-1

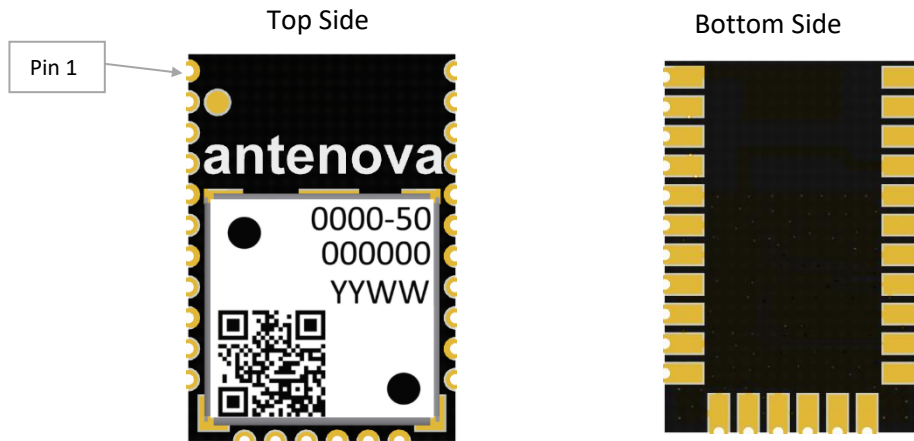

Functional Block Diagram

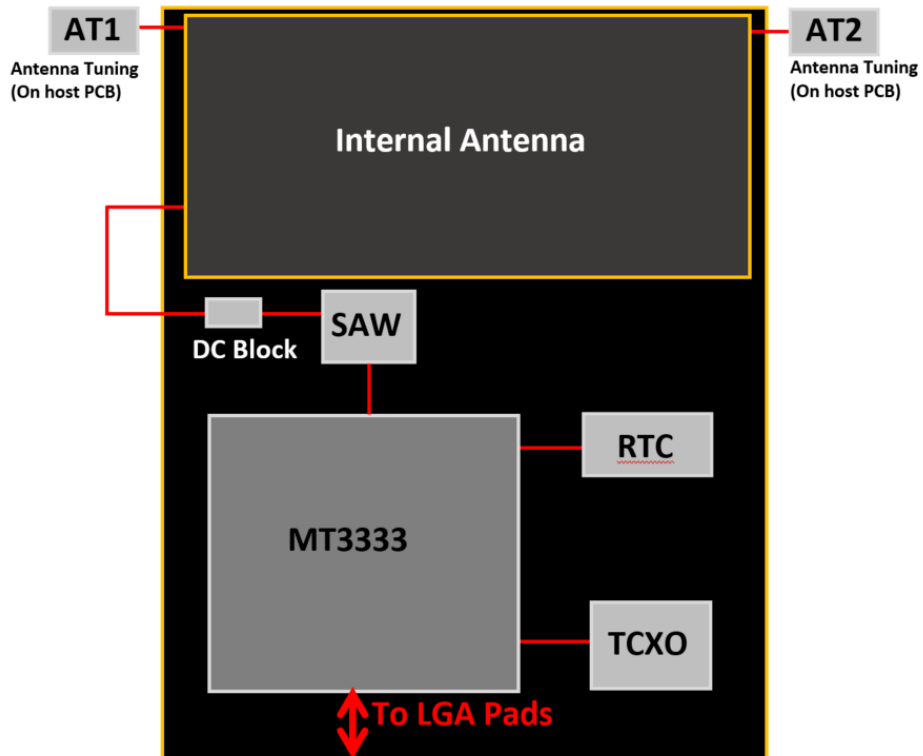

Module Specifications

Absolute Maximum Ratings

| Symbol | Parameter | Min | Max | Unit |
|------------|-------------------------|------|-----|------|
| V_{CC} | Main Supply Voltage | -0.3 | 4.3 | V |
| V_{IO} | Supply voltage I/O ring | -0.3 | 3.6 | V |
| V_{BATT} | VBCKP Supply | -0.3 | 4.3 | V |
| RF_{IN} | Maximum RF Input Power | N/A | +10 | dBm |
| T_{STG} | Storage Temperature | -40 | +85 | °C |
| T_A | Operating Temperature | -40 | +85 | °C |

* Exposure to absolute ratings may adversely affect reliability and may cause permanent damage.

Recommended Operating Conditions

| Symbol | Parameter | Min | Typ | Max | Unit |
|------------|-----------------------|-----|-----|-----|------|
| V_{CC} | Main Supply Voltage | 2.8 | 3.3 | 4.3 | V |
| V_{BATT} | VBCKP Supply | 2.8 | 3.3 | 4.3 | V |
| T_{OP} | Operating Temperature | -40 | - | +85 | °C |

DC Electrical Characteristics

Conditions: $V_{CC} = 3.3V$, $T_{OP} = 25\text{ °C}$

| Symbol | Parameter | Typ | Unit |
|-----------------|-----------------------------------|------|------|
| $I_{CC(PK)}$ | Peak Acquisition Current | 29 | mA |
| $I_{CC(AVG)}$ | Average Tracking Supply Current | 21 | mA |
| $I_{CC(STBY)}$ | Standby (Sleep) Power Supply Mode | <500 | μA |
| $I_{CC(BCKUP)}$ | Backup Mode | 7 | μA |

RF Specifications

Conditions: $V_{CC} = 3.3V$, $T = 25\text{ °C}$, Freq = 1575.420MHz

| Symbol | Parameter | Typ | Unit |
|-------------------|---------------------------------------|-------|------|
| NF_{LNA} | LNA Noise Figure | 2.0 | dB |
| ANT_{RL} | Antenna Return Loss | <-7.0 | dB |
| ANT_{BW} | Antenna Bandwidth at -7dB return loss | 65 | MHz |
| ANT_{EFF} | Antenna Total Efficiency | >57% | % |
| ANT_{EFF_RHCP} | Antenna RHCP Efficiency | >28% | % |

Band Rejection

| Frequency | Standard | Typ* | Unit |
|-----------|--------------------|------|------|
| 698-798 | LTE700 | 43 | dB |
| 824-849 | Cellular CDMA | 43 | dB |
| 869-894 | GSM850 | 43 | dB |
| 880-915 | GSM900 | 43 | dB |
| 1710-1785 | GSM1800/DCS | 44 | dB |
| 1850-1910 | GSM1900/PCS | 46 | dB |
| 1920-1980 | WCDMA | 46 | dB |
| 2400-2492 | WLAN, BT and WiMAX | 50 | dB |
| 2500-2690 | LTE2600 | 52 | dB |

*Does not include antenna rejection.

Mechanical Specifications

| Parameter | Typ | Unit |
|----------------------------------------|-----------------------------------------------|------|
| Module exterior dimensions (L x W x H) | 13.8 (±0.1) x 9.5 (±0.1) x 1.8 (+0.2 / - 0.0) | mm |
| Module support and connection | Surface mounted (SMD) | - |
| Module mass | <1 | g |

System Specifications

| Communication | Specification |
|--------------------------------|----------------------------------------------------|
| Data Output Protocol | NMEA 0183 |
| Host Interfaces | UART |
| Default data rate on UART | 9600 default rate, modify by input command |
| GPS Engine | |
| Chip | MTK MT3333 FLASH Chip |
| Channels | 210 PRN / 66 Acquisition / 22 Tracking |
| TCXO | 0.5ppm |
| Accuracy | |
| Horizontal Position Accuracy | <2.5m CEP |
| Maximum Position Update Rate | 10 Hz (Default 1Hz) |
| Sensitivity | |
| Acquisition (Cold) | -148dBm |
| Acquisition (Hot) | -163dBm |
| Tracking | -165dBm |
| TTFF | |
| Hot Start | <1s |
| Warm Start | <25s (typical) |
| Cold Start | <35s (typical) |
| General | |
| Maximum Altitude | <18.000 km |
| Maximum Speed | <514 m/s |
| Active Interference Cancellers | 12 multi tone active cancellers ISSCC2011 award |
| Additional Features | 1PPS Sync |
| EPO / EASY | Orbit prediction |

50% CEP, Open-Sky, 24hr Static, -130dBm, good view of the sky

Pin out Description

Table shows the designation and function of each pin on the M20050-1 module.

| Pin | Designator | Description |
|-----|------------|-------------------------------------------------------------|
| 1 | AT1 | Tuning Left side |
| 2 | GND | Ground connection |
| 3 | GND | Ground connection |
| 4 | ANT_OUT | RF from internal antenna to external pin (Connect to pin 6) |
| 5 | GND | Ground connection |
| 6 | ANT_IN | RF Input from antenna |
| 7 | GND | Ground connection |
| 8 | VCC | Main DC supply, +2.8V to +4.2V |
| 9 | GND | Ground connection |
| 10 | HW_R | System reset, active low |
| 11 | TM | 1PPS Time Mark Out |
| 12 | BV | Backup Voltage +2.0V to +4.2V |
| 13 | E2 | Not used |
| 14 | E3 | Not used |
| 15 | GND | Ground connection |
| 16 | GND | Ground connection |
| 17 | GND | Ground connection |
| 18 | FIX | Indicates once a GPS fix has been obtained. |
| 19 | GND | Ground connection |
| 20 | TX | UART Transmit data line |
| 21 | RX | UART Receive data line |
| 22 | GND | Ground connection |
| 23 | GND | Ground connection |
| 24 | GND | Ground connection |
| 25 | GND | Ground connection |
| 26 | HW_S | Used to enable standby mode. If not used leave floating. |
| 27 | GND | Ground connection |
| 28 | AT2 | Tuning Right Side |

Mechanical

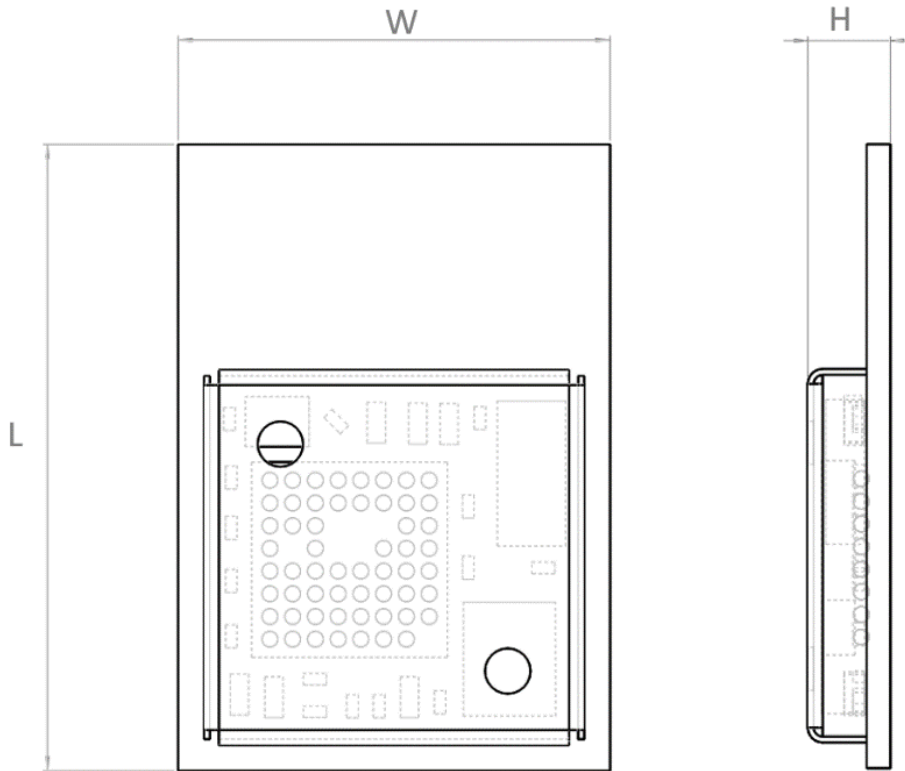

All dimensions in mm

| L | W | H |
|-----------|----------|------------------|
| Length | Width | Height |
| 13.8 ±0.1 | 9.5 ±0.1 | 1.8 +0.2 / - 0.0 |

Application Schematic Example for M20050-1:

The circuit below shows a basic design for use with the UART interface and configuring the default baud rate to 9600.

Baud Rate = 9600 (Default)

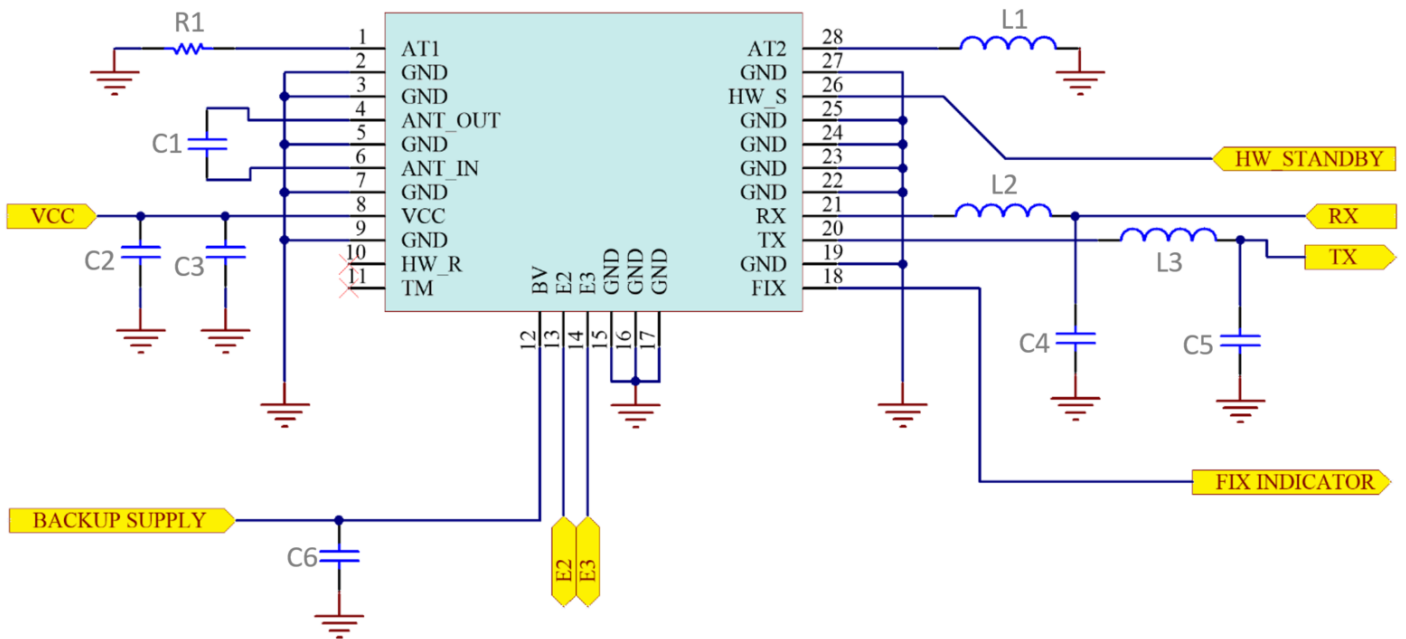

Bill of Material

| Designator | Value | Description/Comments | Quantity |
|--------------------|-----------------|--------------------------------------------------|----------|
| C1, C2, C4, C5, C6 | 22pF capacitor | Decoupling cap. Place close to corresponding pin | 5 |
| C3 | 2.2uF capacitor | Decoupling cap. Place close to corresponding pin | 1 |
| L1 | 1.8nH | Tuning Inductor for antenna | 1 |
| L2, L3 | 47nH Inductor | Filter component | 2 |
| R1 | 0R Resistor | Tuning Resistor for antenna | 1 |

Host Interface

UART Interface

The UART converts bytes of data to and from asynchronous start -stop bit streams as binary electrical impulses. The port contains a 16-byte FIFO, and 256 bytes of URAM. The bit rates are selectable from 4800, 9600, 38400 and 115200 bps.

The IO level from the UART port are CMOS compatible, however for RS232 compatibility the use of external level shifters will be required. The hardware configuration of the port baud can be changed dynamically by the use of commands. These will be active and saved as long as the VBACKP supply is applied.

Power Supply

The M20050-1 uses two DC supply inputs, VBACKUP to power the RAM and RTC sections of the receiver, and VCC to power the digital and processing sections. VBACKUP is to be applied all the time to keep these sections alive. VCC can be removed to initiate a backup power save mode (See page 10). VBACKUP can be removed if a battery is also used at VBACKUP to maintain this supply. The supply is internally regulated for 2.8V meaning the external supply is versatile for a range of voltage levels.

TM (1PPS)

TM is a one pulse per second output from the receiver providing uses for timing purposes. The pulse width is 100ms.

HRST (Hardware Reset Pin)

The External reset pin is default high by an internal 75Kohm and should be left floating if not used. To initiate a reset the pin needs to be pulled low. The module also initiates a reset if the VCC drops below the minimum 2.8V supply.

Power Management

The M20050-1 has three power saving modes.

- Standby mode
- Back up mode
- Periodic mode

Standby Mode

Standby mode is a power saving mode that shuts down the RF section of the module and puts the processor into a standby mode. The RTC is kept alive and the RAM power is maintained to keep the module configuration.

The standby state can be initiated either with a hardware signal to Pin26 or by using a command.

Hardware controlled Standby:

Enable standby mode by a low state to pin 26 (HW_S). To wake the module back to full power a high state needs to be applied to pin 8. If Pin 8 is not to be used then it must be kept floating (not connected).

Standby mode command:

Software on the host needs to send the "PMTK161 command through the UART interface.

| Command | M20050-1 standby then wakeup | Current consumption (Typ) |
|----------------|-------------------------------------|---------------------------|
| \$PMTK161,0*28 | M20050-1 enters standby mode | <500uA |
| Any byte | M20050-1 wakes up from standby mode | |

Back up mode

To enter backup mode the VCC simply needs to be removed. Once initiated the RTC and all configuration is saved along with any ephemeris data to allow quick TTFF once the VCC is re-applied. BV needs to be applied always for backup mode to run correctly.

Periodic mode

Periodic mode is a module controlled mode that reduces current consumption by only waking the module for short periods to maintain fix data. The periodic state is user configured. Contact Antenova for more information and a user command manual.

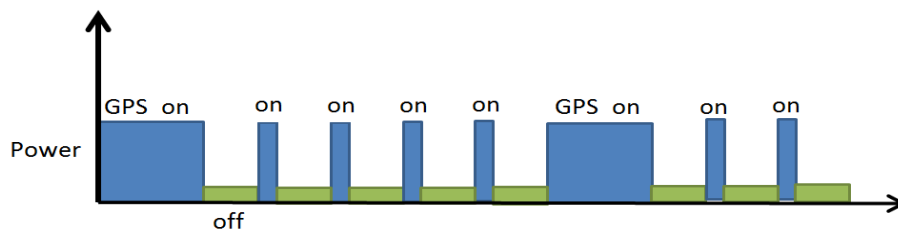

| PMTK225 setting | M20050-1 time off/awake | Current usage (Typ) |
|--------------------------------|--------------------------------------------------------------------------------------------------|---------------------|
| PMTK225, 2,3000,18000,72000 | Module sleeps for 12secs, then wakes for 3secs periodically. 72000 is for a cold boot condition. | <500uA |

EPO (Extended Prediction Orbit) data service

The EPO allows the use of up to a 30-day orbit prediction that can be used to aid the module for an instant fix solution.

- A proxy server on the customer's side to update EPO files from the MTK server daily.
- Application software to access the proxy server through the internet (optional if host device can access internet)
- Software on host device to send EPO data to M20050-1 module to allow instant fix by using EE data. Please contact Antenova for more information. Requires permission from MTK to use service.

EASY (Self-Generated Orbit prediction)

The module supports EASY™ (Embedded Assisted System) is a Self-Generated Orbit Prediction feature. It provides up to 3 days GPS orbit prediction ability without the need for any host CPU porting or internet connection requirements.

EASY works as embedded software which accelerates TTFF by predicting satellite navigation messages from received ephemeris. EASY is a fully automated receiver task that is efficiently scheduled and computed in free time of every second after a GNSS navigation solution.

EASY is default off and can be enabled by a PMTK command.

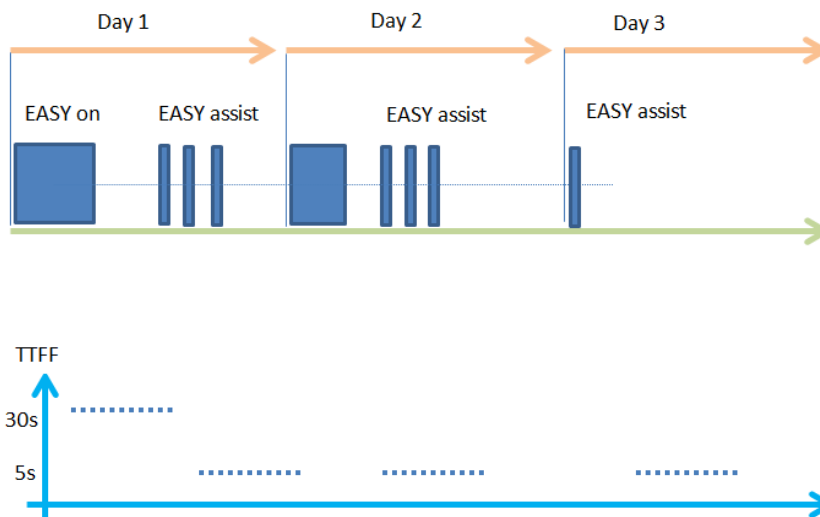

AIC (Active Interference Cancellation)

The AIC feature provides effective narrow-band interference and jamming elimination. The GPS signal can be recovered from the jammed signal and allows users to obtain better navigation quality. This can be beneficial since many of today's devices have increasing functionality with regards to transmitters with many on-board antennas.

External Matching

The M20050-1 module uses matching circuit components on the host PCB to fine-tune the on-board antenna to each specific application. This “external matching” allows compensating for the detuning of the antenna caused by various components that can be close to the M20050-1 module in the actual application (plastic case, battery, speakers etc).

The external matching must be placed on the host PCB from pads AT1(Pad 1) and AT2 (Pad 28). A single component from each pin to GND is all that is required. This should be placed close to the modules pads.

Schematic

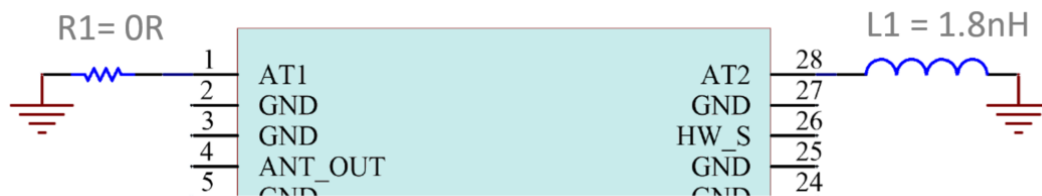

In the example above AT1 only required a 0R resistor and AT2 uses a small 1.8nH inductor to tune the antenna. Both components should be designed in as both may be required for the intended device.

Type of Matching Components

- Capacitors:
 - Use 0402, COG components
- Inductors:
 - High-Q, wire wound inductors in 0402 sizes are recommended for maximum performance, e.g. Murata LQW15 series
 - Good quality multi-layer type inductors (e.g. Murata LQG15 series) can also be used as a lower cost alternative

External Antenna Support

A low cost external circuit can be used to provide external antenna support. Please contact Antenova for more information, and example circuit.

Internal Antenna Clearance

The M20050-1 module internal antenna requires a small clearance on the host PCB to operate. The clearance means that no Ground or tracks of any kind can be within this area. This must also be clear through the entire PCB stack up. The minimum area needed clear is 6mm X 4.87mm.

Top view of M20050-1 host PCB footprint

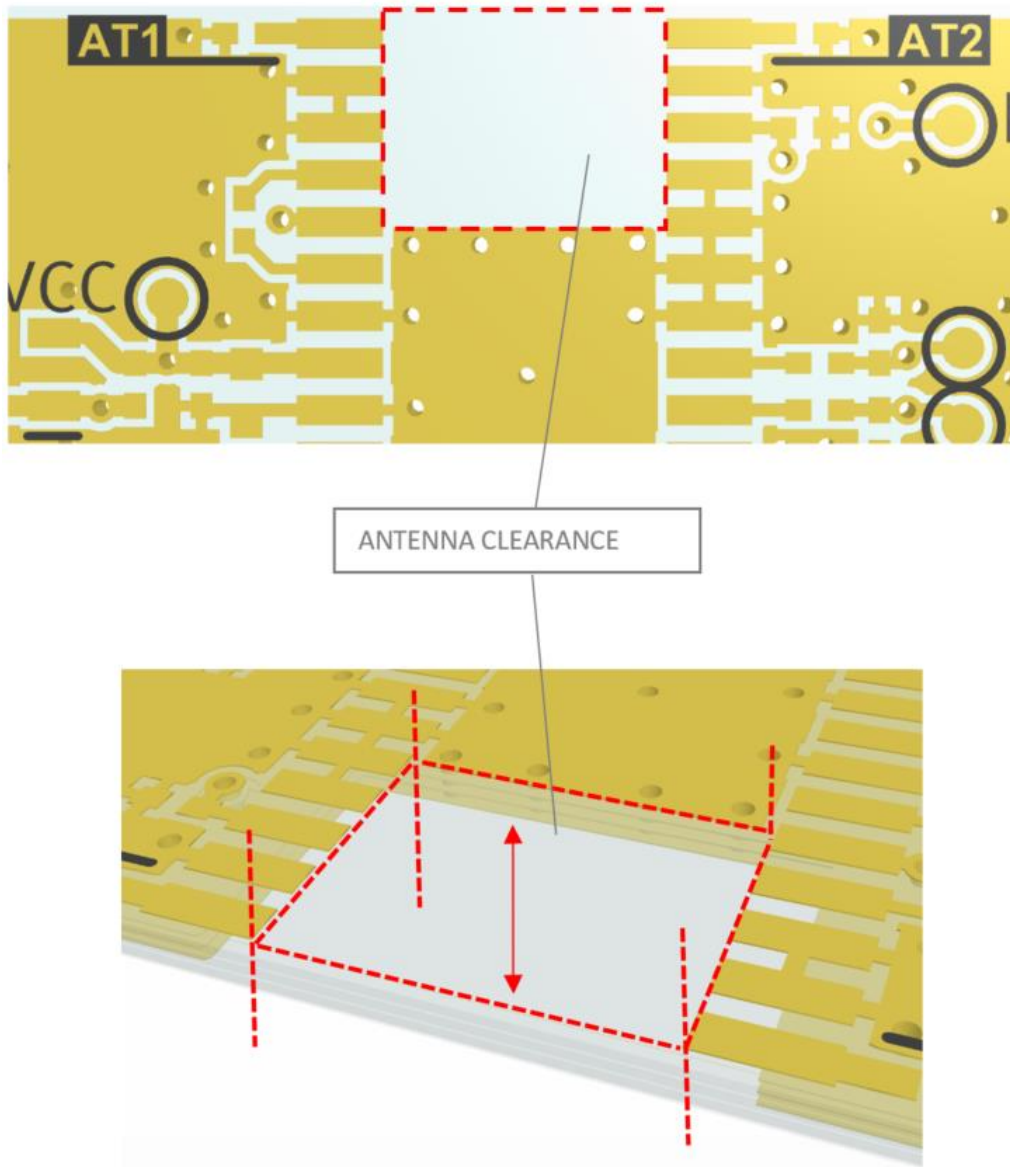

Typical Antenna Matching Results

Typical antenna matching as seen by ANT_IN (Pin 3) is shown in the following plot. The matching bandwidth at -7dB is typically 65MHz. Measured on M20050-EVB-1 test board.

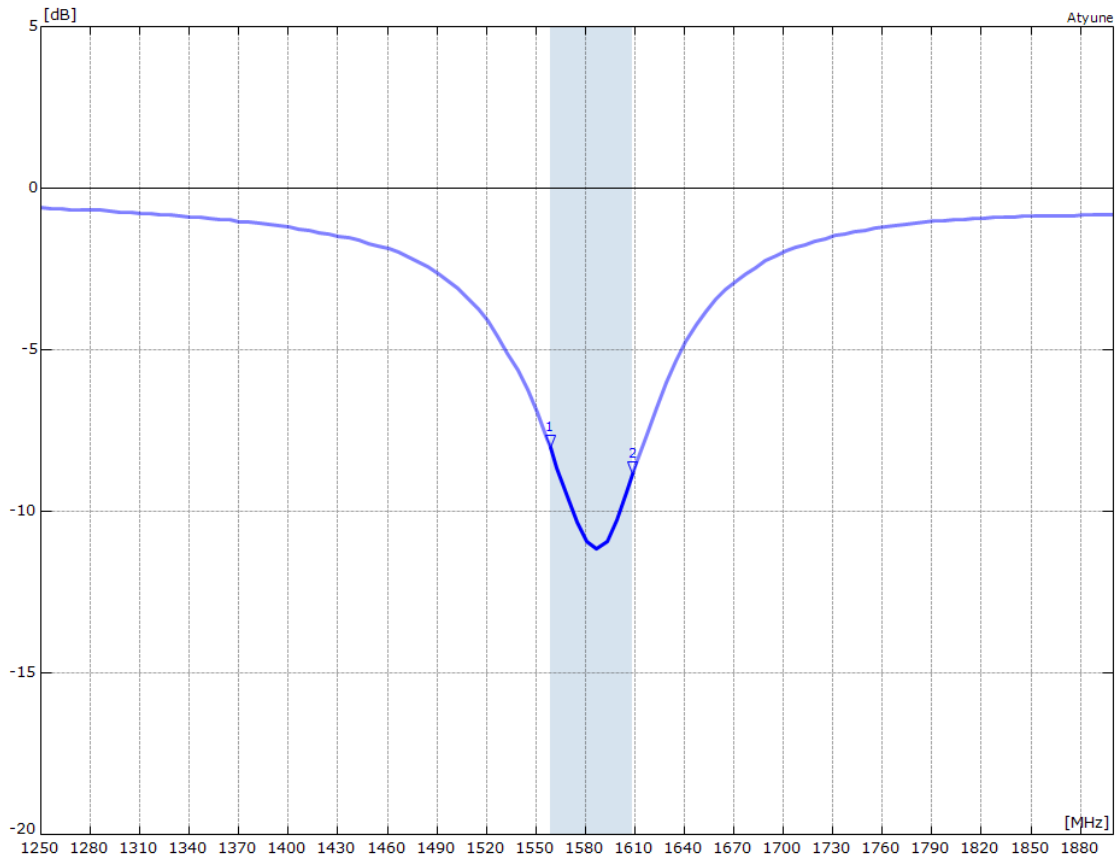

Front-end Rejection

The figure below shows the rejection for the input SAW filter before the RF input, including the effect of pads, tracks, and decoupling. The plot can be useful to calculate the isolation required from adjacent transmitters to avoid the saturation of the LNA.

Input SAW Rejection – Wideband

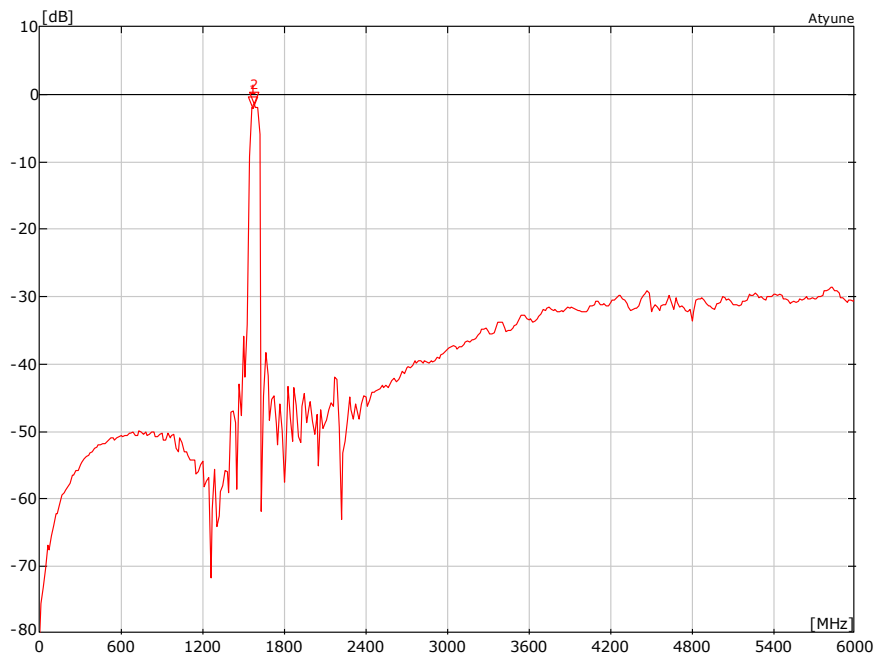

Input SAW Rejection - Narrowband

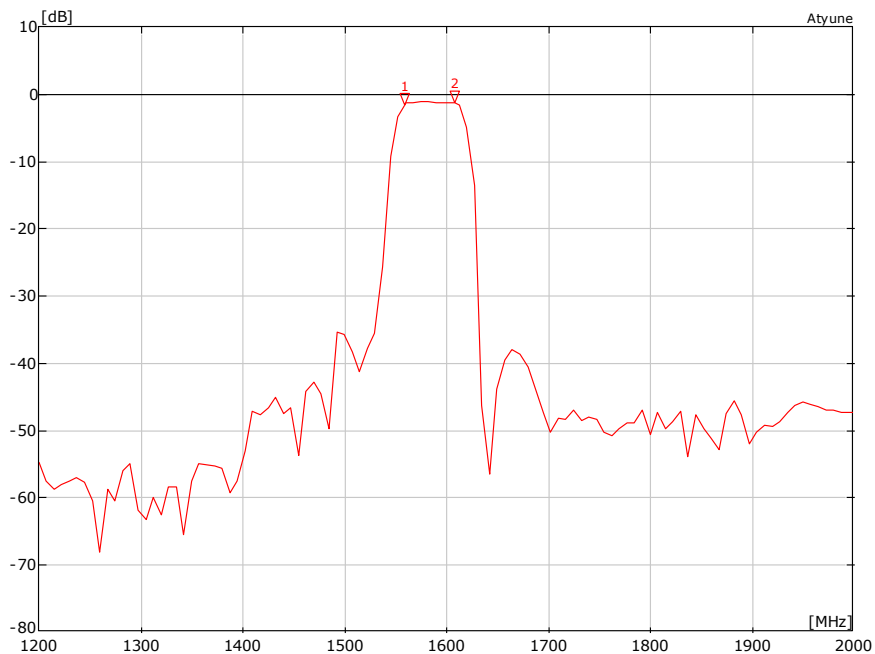

Module Placement Guidelines

Due to the internal antenna, care must be taken when defining the placement of the module on the host PCB. Here are some guidelines that should be used when deciding the position of the module.

- The module top edge must be placed almost level with the edge of the host PCB
- The edge of the host PCB that the module is to be placed at must be a minimum of 40mm in length.

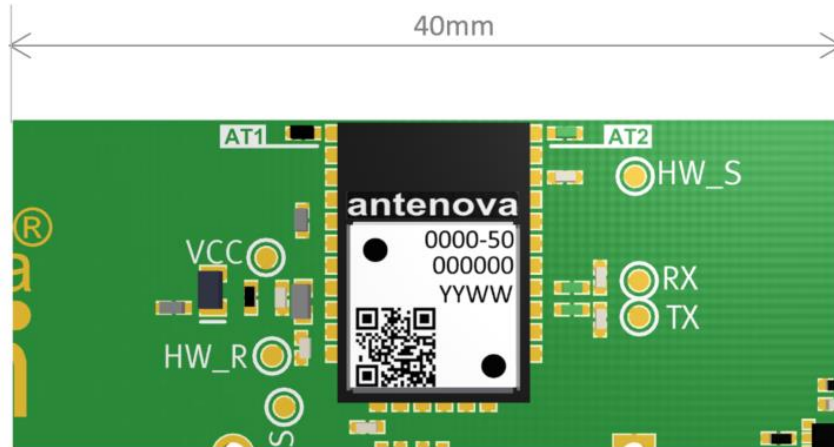

- The central placement of the module is advised. However, an offset placement is also possible.
- For an offset closer to the PCB edge to the right side of the module, a minimum of 10mm distance is required to the edge of the host PCB.

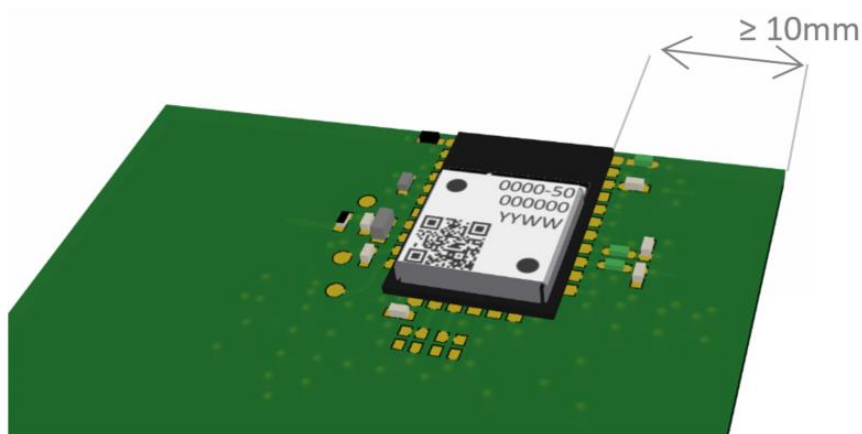

GPS RADIONOVA® RF Antenna Module

Part No. M20050-1

- The antenna uses the host PCB ground to effectively radiate. As such, a GND plane must be placed on the host PCB on at least one layer.
- In the example below, the only area void of GND is the antenna keep-out area. The solder mask is removed to make the copper visible.

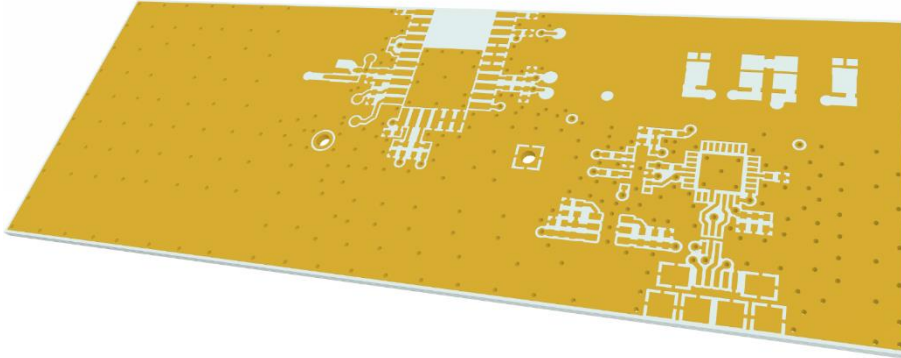

- An ideal stack-up for a host PCB would be to use the top and bottom layers as GND planes, while using the internal layers for any signal and power planes. This not only helps the GPS antenna to perform effectively, but also helps to reduce any potential noise issues that can be associated with mixed signal PCB's.
- An example below shows a 4-layer host PCB, GND flooding all available space not used by signals or components.

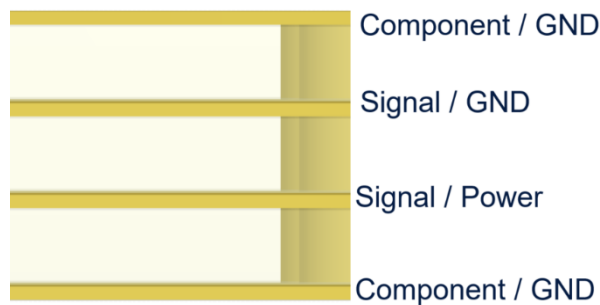

Please contact Antenova M2M for advice on placement.

Evaluation Kit

The EVK is a single PCB that contains the module and required components to run on a PC via a USB cable and Antenova software. Evaluation kits are available on request. Please contact Antenova for more information.

M20050-EVB-1

Top Side

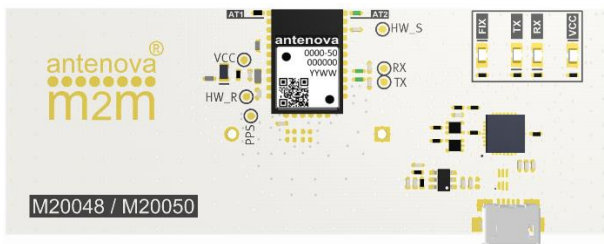

Bottom Side

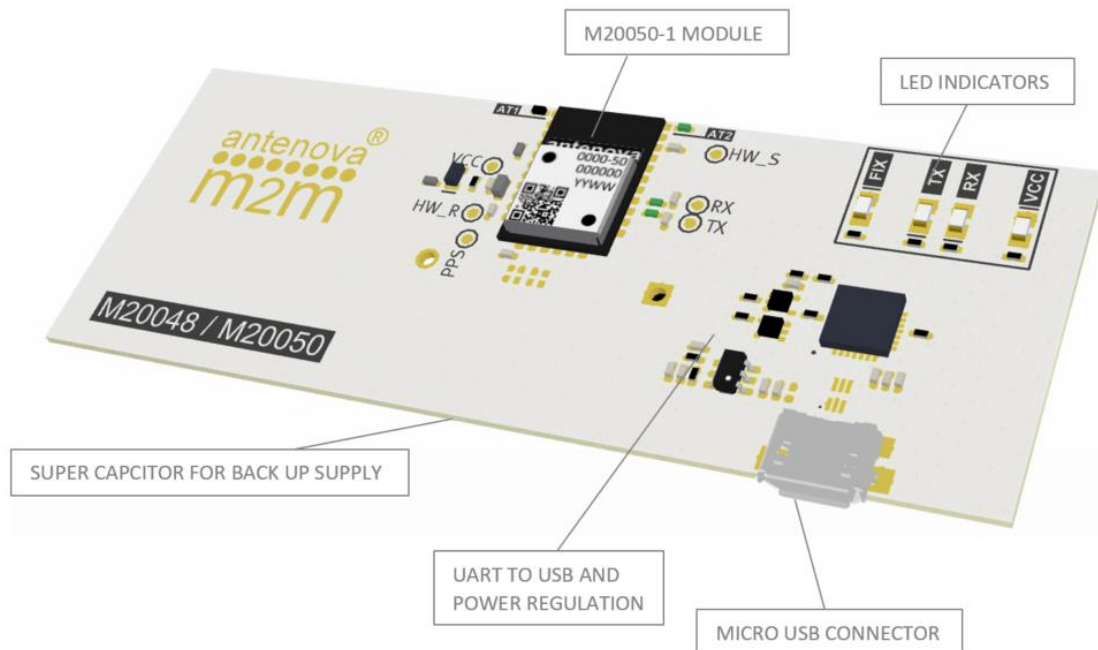
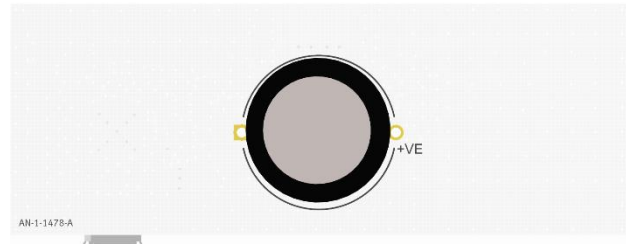

Reflow Soldering

Placement

Typical placement systems used for any BGA/LGA package are acceptable. Recommended nozzle diameter for placement: 5mm.

Soldering Paste

Use of “No Clean” soldering paste is strongly recommended, as it does not require cleaning after the soldering process has taken place. An example of suitable soldering paste is Alpha OM350.

Soldering

The recommended soldering profile for M20050-1 is shown below. However, it is the responsibility of the Contract Manufacturer to determine the exact reflow profile used, taking into consideration the parameters of the host PCB, solder paste used, etc.

| Profile Feature | | Pb-Free Solder |
|-------------------------------------------------------|----------------------------------|----------------|
| Pre-Heat | Temperature (T_s) Min | 130°C |
| | Temperature (T_s) Max | 220°C |
| | Time (t_s) | <150s |
| Reflow | Liquidus Temperature - (T_l) | 220°C |
| | Time (t_l) | 45-90s |
| Peak Package Body Temperature (T_p) | | 245°C |
| Time within 5°C of peak temp (t_p) | | 30s |
| Average Ramp up rate - $T_s(\text{max})$ to (T_p) | | 3°C/s |
| Ramp Down Rate | | 6°C/s max |

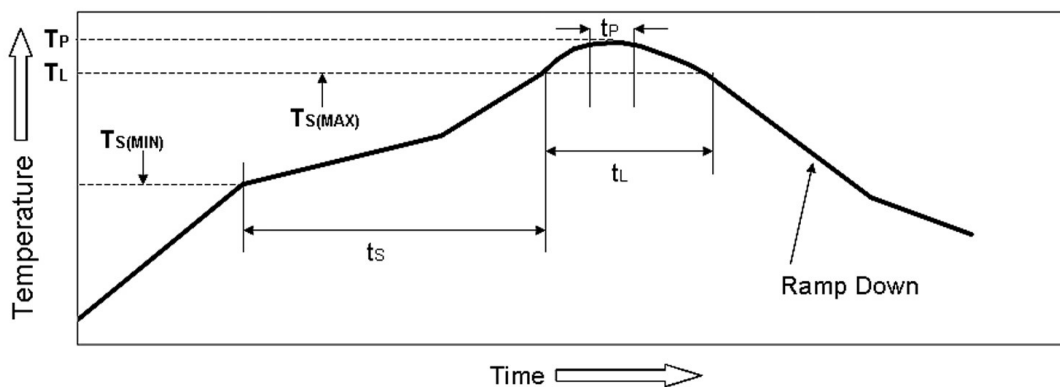

Example Reflow profile

The Pb Free Process-Package Peak Reflow Temperature is 260°C.

Exceeding the maximum soldering temperature could permanently damage the module.

Multiple Soldering

The M20050-1 module can be submitted up to 2 reflow soldering processes.

Upside-down soldering is acceptable but it is recommended that the Contract Manufacturer qualify the process before mass production. The second reflow must take place within the recommended floor life limit (MSL3). Please contact Antenova for further information.

Hand Soldering

Hand-soldering and rework of the M20050-1 module is acceptable, however care must be taken to avoid short circuits due to the small size of the module pads.

Quality and Environmental Specifications

| Test | Standard | Parameters |
|-----------------------------|------------------------------------------------------------------------------------------------------------------------------------------------------|-----------------------------------------------------------------------------------------------------------|
| PCB Inspection | IPC-6012B, Class 2. Qualification and Performance Specification for Rigid Printed Boards - Jan 2007 | |
| Assembly Inspection | IPC-A-610-D, Class 2 "Acceptability of electronic assemblies" | |
| Temperature Range | ETSI EN 300 019-2-7 specification T 7.3 | -30 °C, +25 °C, +85 °C, operating |
| Damp Heat | ETSI EN 300 019-2-7 specification T 7.3 | +70 °C, 80% RH, 96 hrs, non-operating |
| Thermal Shock | ETSI EN 300 019-2-7 specification T 7.3 E | -40 °C ... +85 °C, 200 cycles |
| Vibration | ISO16750-3 | Random vibration, 10~1000Hz, 27.8m/s ² , 8hrs/axis, X, Y, Z 8hrs for each 3 axis non-operating |
| Shock | ISO16750-3 | Half-sinusoidal 50g, 6ms, 10time/face, ±X, ±Y and ±Z non-operating |
| Free Fall | ISO16750-3 | 1m height, 2 drops on opposite side |
| ESD Sensitivity | JEDEC, JESD22-A114 ESD Sensitivity Testing Human Body Model (HBM), Class 2 JEDEC, JESD22-A115 ESD Sensitivity Testing Machine Model (MM), Class B | +2000V - Human hand assembly +200V - Machine automatic final assembly |
| Shear | IEC 60068-2-21, Test Ue3: Shear | Force of 5N applied to the side of the PCB |
| Moisture/Reflow Sensitivity | IPC/JEDEC J-STD-020D.1 | MSL3 |
| Storage (Dry Pack) | IPC/JEDEC J-STD-033C | MSL3 |
| Solderability | EN/IEC 60068-2-58 Test Td | More than 90% of the electrode should be covered by solder. Solder temperature 245 °C ± 5 °C |

Moisture Sensitivity

Antenova ships all devices dry packed in tape on reel with desiccant and moisture level indicator sealed in an airtight package. If on receiving the goods the moisture indicator is pink in colour or a puncture of the airtight seal packaging is observed, then follow J-STD-033 "Handling and Use of Moisture/Reflow Sensitive Surface Mount Devices".

Storage (Out of Bag)

The M20050-1 modules meet MSL Level 3 of the JEDEC specification J-STD-020D - 168 hours Floor Life (out of bag) ≤30 °C/60% RH. If the stated floor life expires prior to reflow process then follow J-STD-033 "Handling and Use of Moisture/Reflow Sensitive Surface Mount Devices".

Hazardous material regulation conformance

The RF antenna module meets RoHS requirements.

Packaging

Tape Characteristics

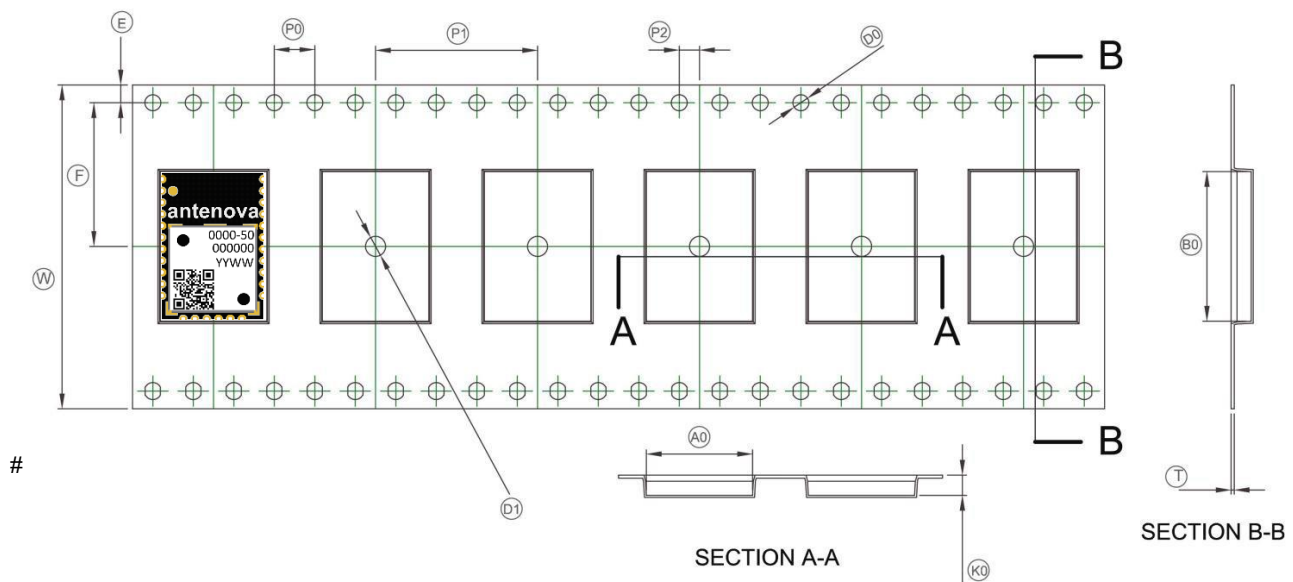

| W | F | E | P0 | P1 | P2 |
|-----------|-----------|----------|----------|------------|----------|
| 32.00±0.3 | 14.20±0.1 | 1.75±0.2 | 4.00±0.1 | 16±0.1 | 2.00±0.1 |
| D0 | B0 | T | K0 | A0 | D1 |
| 1.55±0.1 | 14.80±0.1 | 0.30±0.1 | 2.00±0.1 | 10.50±0.05 | 0.85±0.1 |

Dimensions in mm

| Quantity | Leading Space | Trailing Space |
|-----------------|-------------------------|-------------------------|
| 1000 pcs / reel | 50 blank module holders | 50 blank module holders |

Reel Dimensions

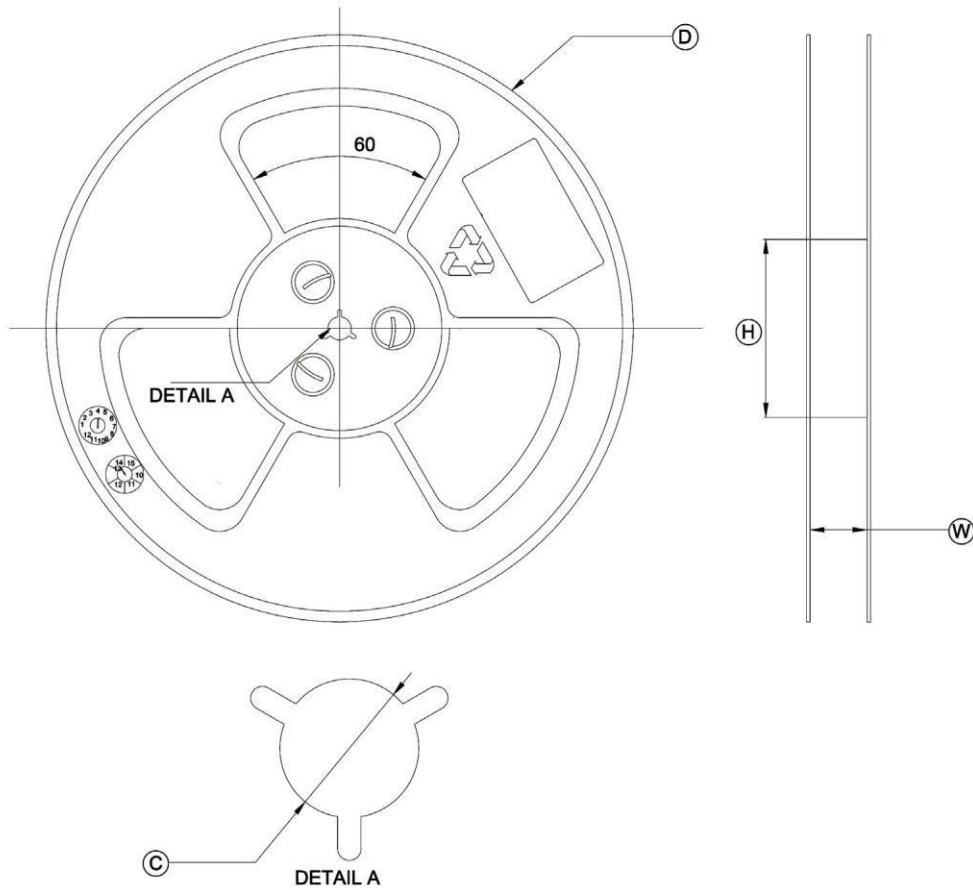

| Width (W) | Reel Diameter (D) | Hub Diameter (H) | Shaft Diameter (C) |
|--------------|----------------------|---------------------|-----------------------|
| 32.0mm | 330.0±2mm | 100.0mm | 13.0+0.2/-0.0mm |



www.antenova-m2m.com

Corporate Headquarters

Antenova Ltd.
2nd Floor, Titan Court,
3 Bishop Square,
Hatfield, AL10 9NA
UK

Tel: +44 (0) 1223 810600
Email: sales@antenova-m2m.com

USA Headquarters

Antenova USA
100 Brush Creek Road, Suite 103,
Santa Rosa,
CA 95404
USA

Tel: +1 (707) 890 5202
Email: sales@antenova-m2m.com

Asia Headquarters

Antenova Asia Ltd.
4F, No. 324, Sec. 1, Nei-Hu Road
Nei-Hu District
Taipei 11493
Taiwan, ROC

Tel: +886 (0) 2 8797 8630
Fax: +886 (0) 2 8797 6890
Email: sales@antenova-m2m.com

Copyright® Antenova Ltd. All Rights Reserved. Antenova®, Antenova M2M, RADIONOVA® and the Antenova and Antenova M2M logos are trademarks and/or registered trademarks of Antenova Ltd. Any other names and/or trademarks belong to their respective companies.

The materials provided herein are believed to be reliable and correct at the time of print. Antenova does not warrant the accuracy or completeness of the information, text, graphics or other items contained within these information. Antenova further assumes no responsibility for the use of this information, and all such information shall be entirely at the user's risk.



Antennas for Wireless M2M Applications

X-ON Electronics

Largest Supplier of Electrical and Electronic Components

Click to view similar products for [GPS Modules](#) category:

Click to view products by [Antenova](#) manufacturer:

Other Similar products are found below :

[ISM3333-C6.1](#) [S2-105V4-Z185K](#) [GPS-11858](#) [SL871GPS232R001](#) [DD-14239](#) [GPS-10922](#) [M20050-1](#) [M20048-1](#) [NEO-M8M-0](#) [S2-105Y0-Z1E0G](#) [NEO-M8P-0](#) [SIM28ML](#) [EWM-G110H01E](#) [WISE-4610P-NA](#) [M10578-A3](#) [GPS-13740](#) [A2200-A](#) [A5100-A](#) [MIKROE-4150](#) [28504](#) [L26ADR-S89](#) [L26T-S89](#) [L70B-M39](#) [L76L-M33](#) [L86-M33](#) [L89-S90](#) [L96-M33](#) [S2-10640-Z1G0D](#) [EL.1A](#) [4037735105317](#) [4037735105331](#) [W2SG0084i-B-T](#) [2614021137000](#) [EWM-G108H01E](#) [RXM-GNSS-GM-T](#) [TEL0132](#) [PKG300060P](#) [PKG300071](#) [PKG900000000271T](#) [RXM-GPS-F4-T](#) [RXM-GPS-FM-B](#) [A1084-A](#) [A2100-A](#) [GPS-13670](#) [GYSFFMAXC](#)