

# Similis Antenna for Cellular applications

Part No. SR4C005

lamiiANT<sup>®</sup>

Product Specification

## 1. Features

- Antenna for 3G and LTE applications including MIMO systems.
- GSM850, GSM900, DCS1800, PCS1900, WCDMA2100, LTE B7 (2500-2690 MHz), LTE B40 (2300 – 2400 MHz).
- Maintains high performance on device: DFI (Designed For Integration)
- Low profile innovative design.
- SMD mounting
- Supplied on Tape and Reel
- Automotive temperature rating.

## 2. Description

Similis uses a ground plane on the host PCB to radiate effectively. The antenna itself requires a clearance underneath. An external matching circuit is used to optimise the antenna within a device to the required bands. Ideal for 3G single and MIMO antenna systems.

## 3. Applications

- Femto / Pico base stations
- Portable Devices
- Remote monitoring/ Smart meters
- Network Devices
- Wearable devices



## 4. Part Number

**Similis: SR4C005**



## 5. General Data

|                         |                                                                                      |
|-------------------------|--------------------------------------------------------------------------------------|
| Product name            | Similis                                                                              |
| Part Number             | SR4C005                                                                              |
| Frequency               | 824 – 960MHz<br>1710 – 1990MHz<br>2110 – 2170MHz<br>2300 – 2400MHz<br>2500 – 2690MHz |
| Polarization            | Linear                                                                               |
| Operating temperature   | -40°C to 125°C                                                                       |
| Impedance with matching | 50 $\Omega$                                                                          |
| Weight                  | 2.0 g                                                                                |
| Antenna type            | SMD                                                                                  |
| Dimensions              | 40.0 x 10.0 x 1.6 (mm)                                                               |

## 6. RF Characteristics

|                       | 824 – 960 MHz | 1710 – 1990 MHz |
|-----------------------|---------------|-----------------|
| Peak gain             | 0.9dBi        | 2.50dBi         |
| Average gain (Linear) | -1.50dBi      | -1.5dBi         |
| Average efficiency    | >45%          | >60%            |
| Maximum return loss   | -5dB          | -6dB            |
| Maximum VSWR          | 3.8:1         | 2.8:1           |

|                       | 2110 – 2170 MHz | 2300 – 2400 MHz |
|-----------------------|-----------------|-----------------|
| Peak gain             | 2.50dBi         | 2.50dBi         |
| Average gain (Linear) | -1.50dBi        | -1.70dBi        |
| Average efficiency    | >55%            | >60%            |
| Maximum return loss   | -6dB            | -6dB            |
| Maximum VSWR          | 3.2:1           | 2.8:1           |

|                       | 2500 - 2690 MHz |
|-----------------------|-----------------|
| Peak gain             | 3.20dBi         |
| Average gain (Linear) | -1.70dBi        |
| Average efficiency    | >65%            |
| Maximum return loss   | -5dB            |
| Maximum VSWR          | 3.9:1           |

All data measured on Antenova's evaluation PCB  
Part No. SR4C005-U1

## 7. RF Performance

### 7.1 Return Loss

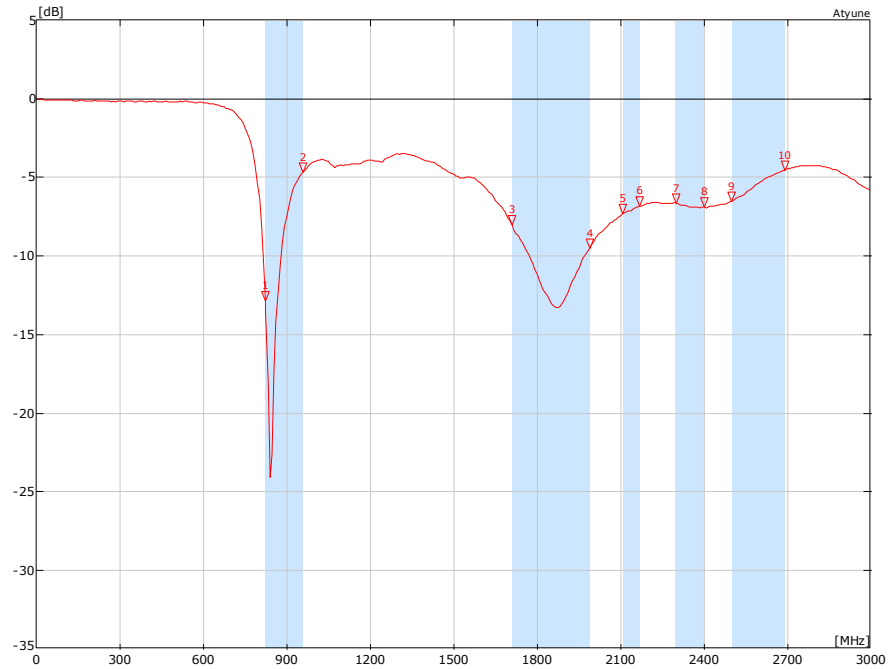

### 7.2 VSWR

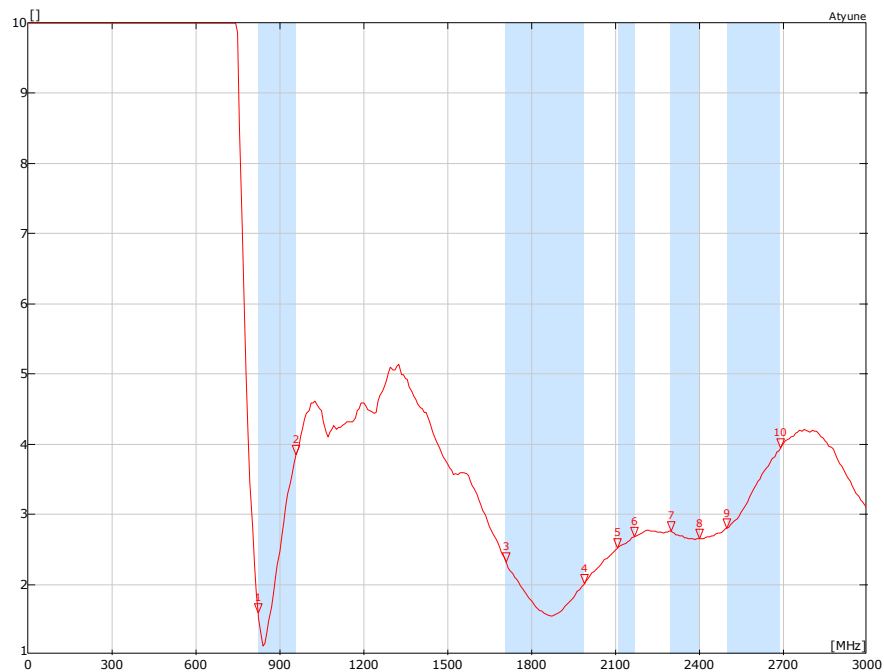

## 7.3 Antenna pattern

### 7.3.1 824 MHz – 960 MHz

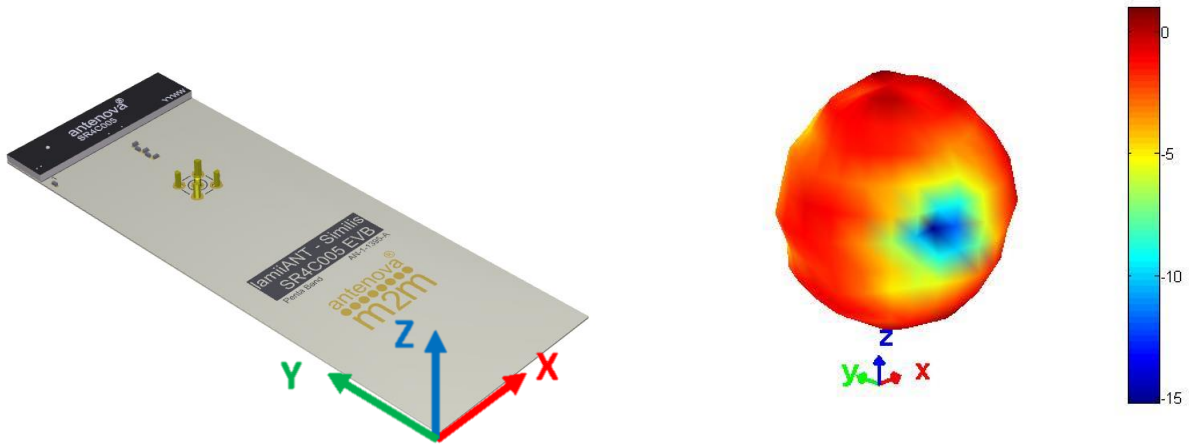

**3D pattern at 880 MHz**  
*Drag to rotate pattern and PCB by using Adobe Reader  
(Click to Activate)*

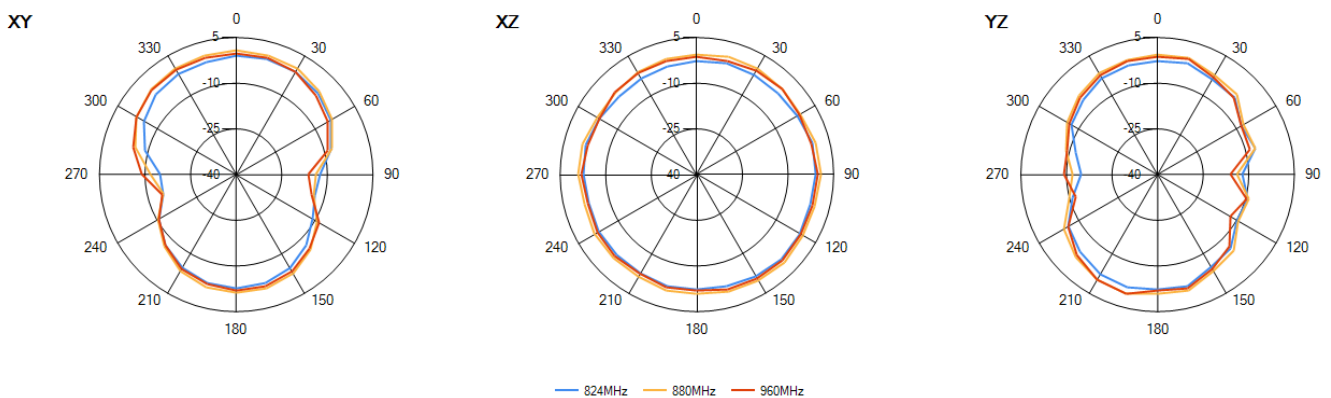

### 7.3.2 1710 MHz – 1990 MHz

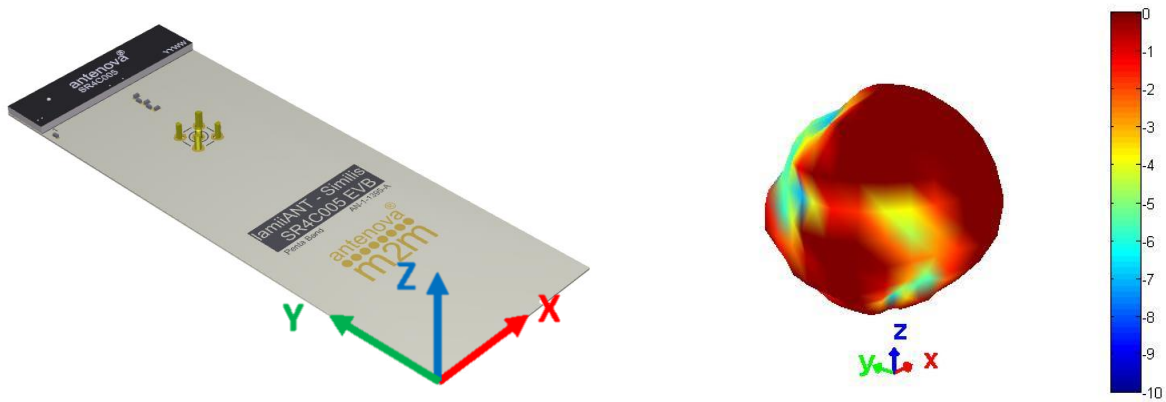

**3D pattern at 1810 MHz**  
*Drag to rotate pattern and PCB by using Adobe Reader  
(Click to Activate)*

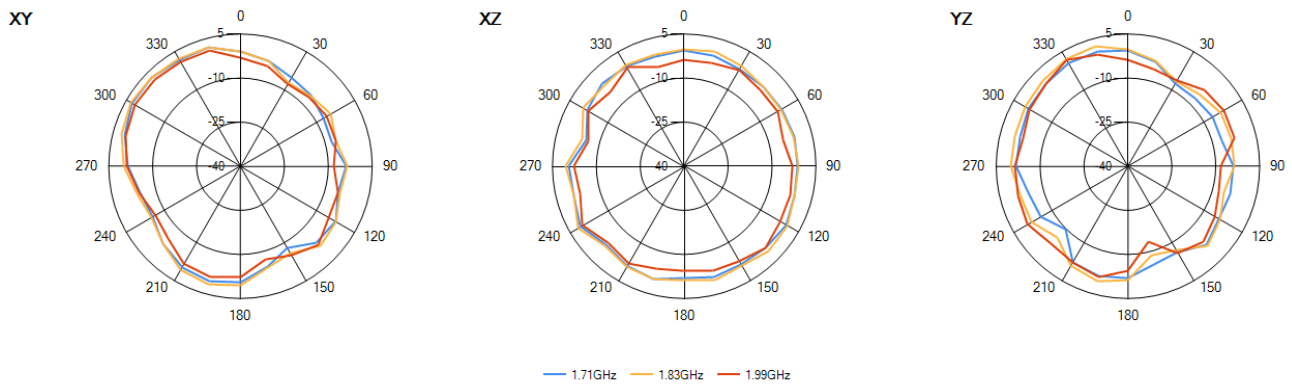

### 7.3.3 2110 MHz – 2170 MHz

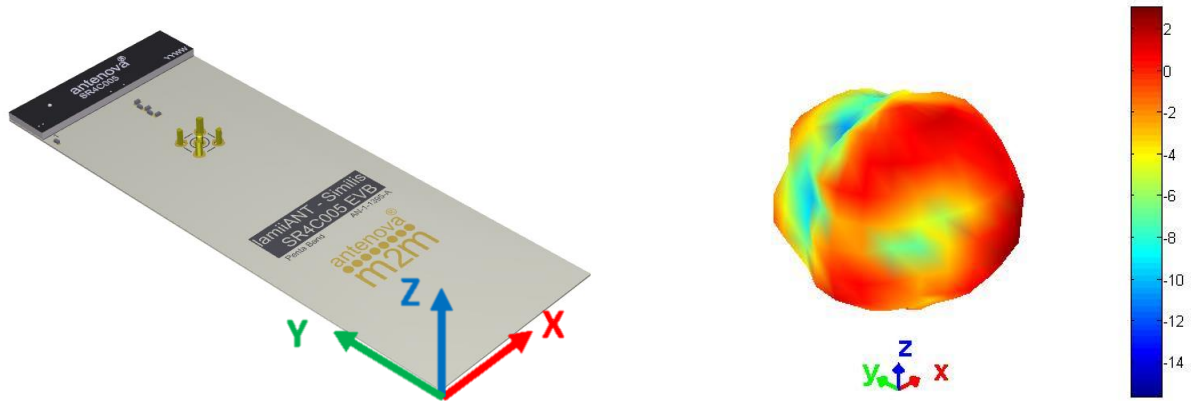

#### 3D pattern at 2110 MHz

Drag to rotate pattern and PCB by using Adobe Reader  
(Click to Activate)

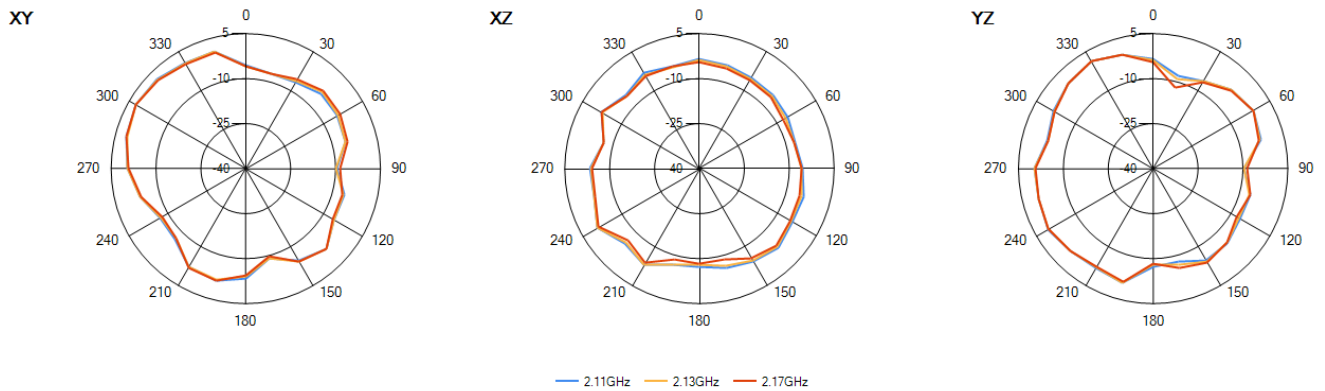

### 7.3.4 2300 MHz – 2400 MHz

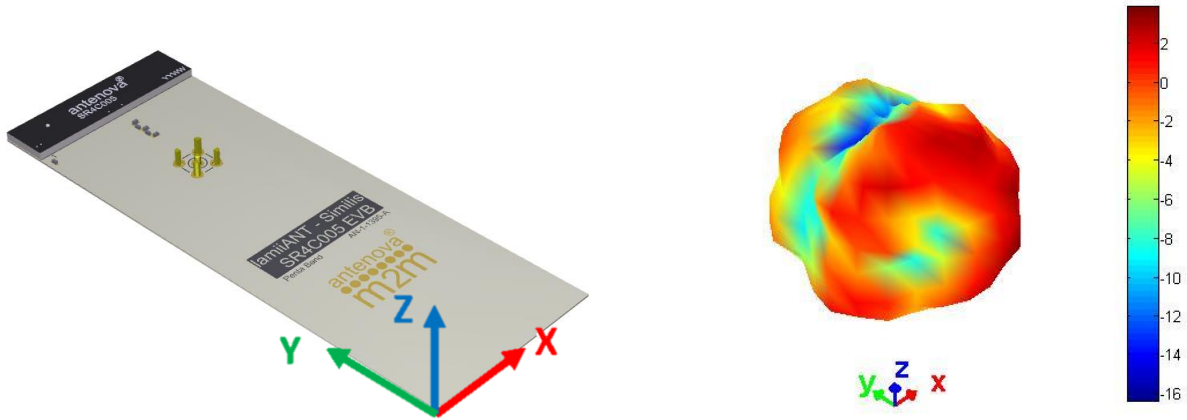

**3D pattern at 2340 MHz**  
*Drag to rotate pattern and PCB by using Adobe Reader  
(Click to Activate)*

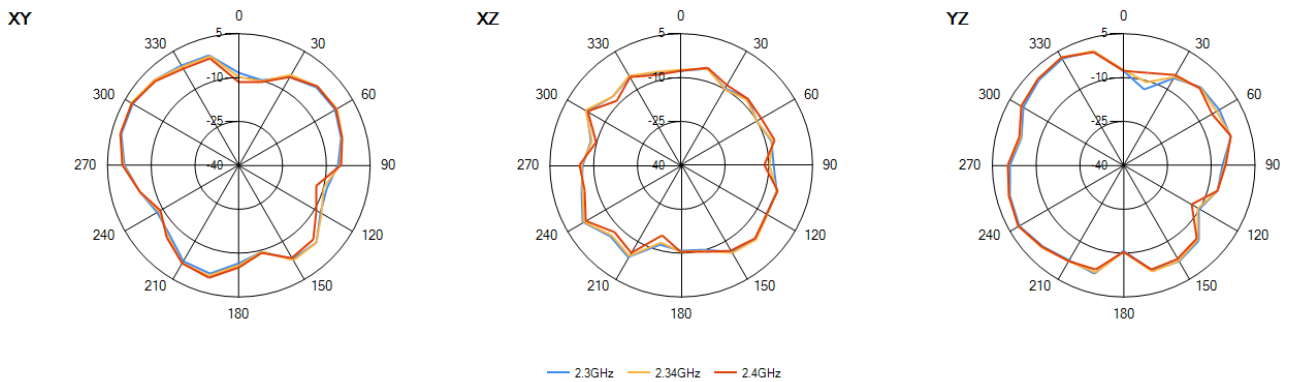



### 7.3.5 2500 MHz – 2690 MHz

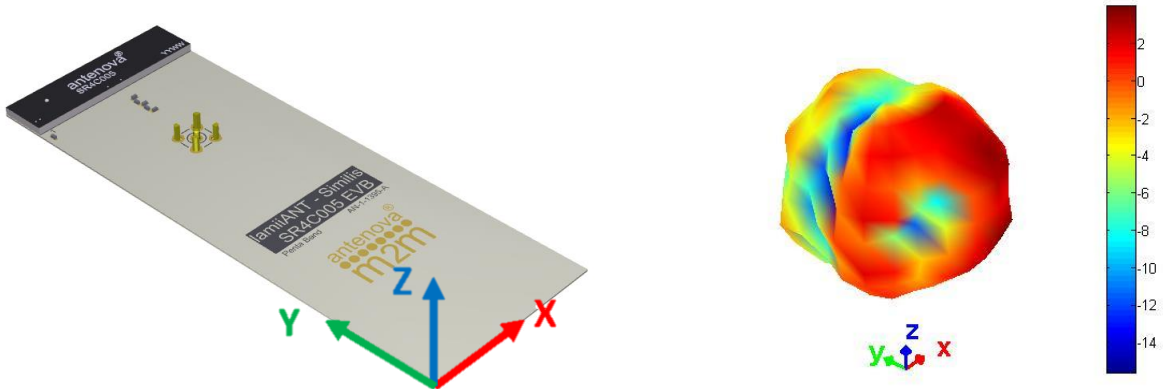

**3D pattern at 2580 MHz**  
*Drag to rotate pattern and PCB by using Adobe Reader  
(Click to Activate)*

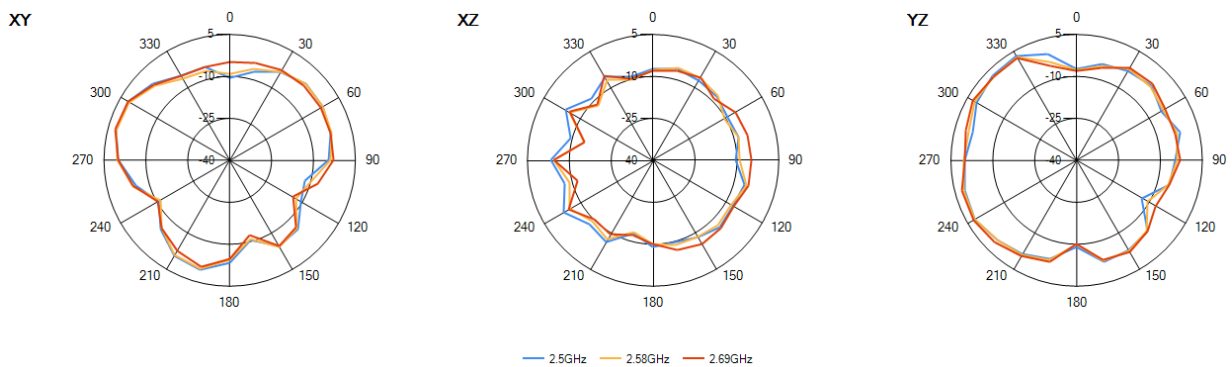

## 8. Antenna Dimensions

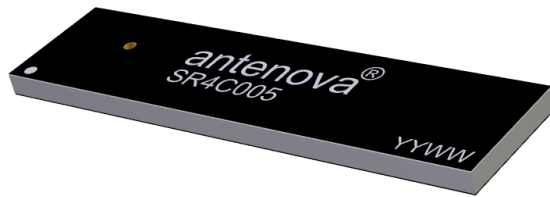

**3D rotational**  
Drag to rotate by using  
Adobe Reader  
(Click to activate)

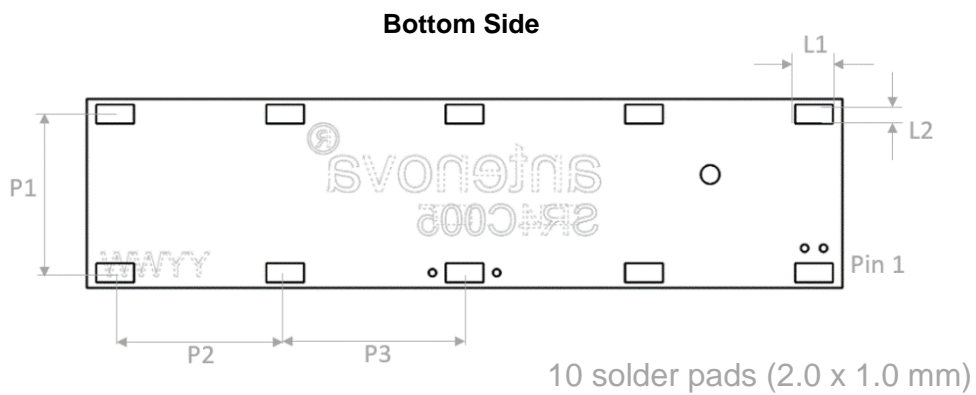
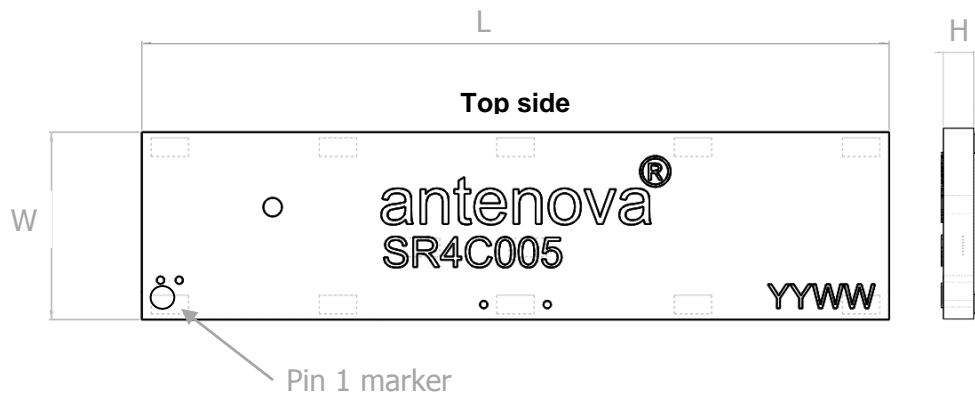

| L         | W         | H             |
|-----------|-----------|---------------|
| Length    | Width     | Height        |
| 40.0 ±0.1 | 10.0 ±0.1 | 1.7 +0.1 -0.0 |

| L1  | L2  | P1  | P2  | P3  |
|-----|-----|-----|-----|-----|
| 2.0 | 1.0 | 8.4 | 9.0 | 9.5 |

All Dimensions in (mm)

Antennas for Wireless M2M Applications

## 10.0 Schematic symbol and Pin definition

The circuit symbol for the antenna is shown below. The antenna has 10 pins with only two as functional. All other pins are for mechanical strength.

| Pin               | Description                   |
|-------------------|-------------------------------|
| 3                 | Feed                          |
| 1                 | Return/GND                    |
| 2,4,5,6,7,8,9,10, | Not used<br>(Mechanical only) |

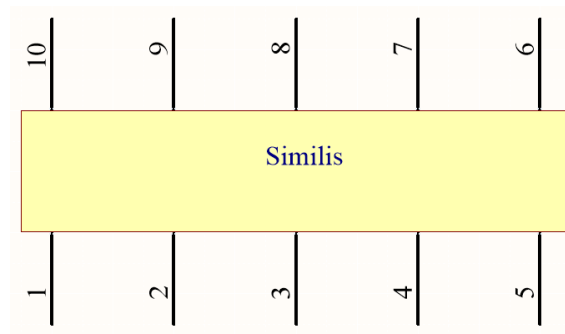

Similis

## 9.0 Antenna footprint

The recommended host PCB footprint is below.

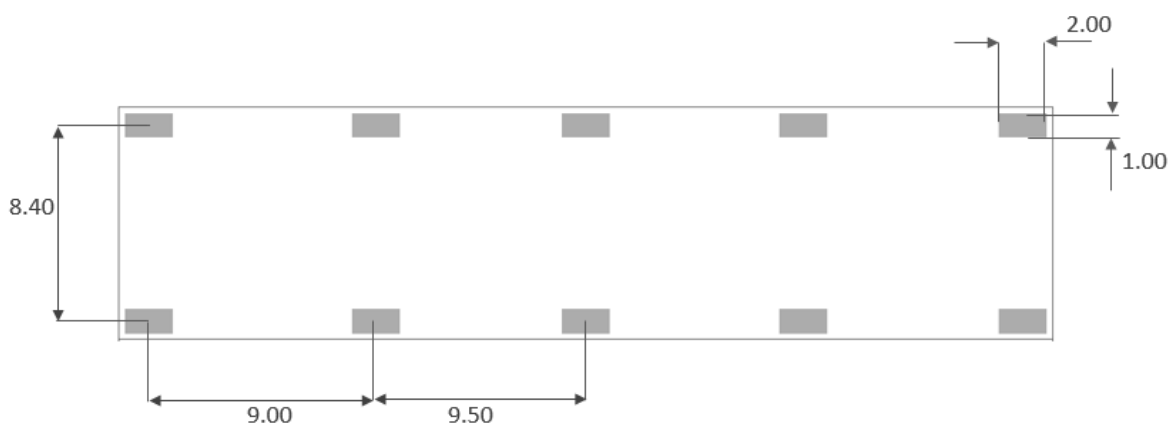

10 copper pads all 2.0 x 1.0 (mm)

## 11. Electrical Interface

### 11.1 Transmission Line

All transmission lines should be designed to have a characteristic impedance of 50Ω.

- The length of the transmission lines should be kept to a minimum
- Any other parts of the RF system like transceivers, power amplifiers, etc, should also be designed to have an impedance of 50 Ω

Once the material for the PCB has been chosen (PCB thickness and dielectric constant), a coplanar transmission line can easily be designed using any of the commercial software packages for transmission line design. For the chosen PCB thickness, copper thickness and substrate dielectric constant, the program will calculate the appropriate transmission line width and gaps on either side of the track so the characteristic impedance of the coplanar transmission is 50 Ω.

### 11.2 Matching Circuit

The antenna requires a matching circuit that must be optimized for each product. The matching circuit will require up to five components and the following circuit should be designed into the host PCB. Not all components may be required but should be included as a precaution. The matching network must be placed close to the antenna feed to ensure it is more effective in tuning the antenna.

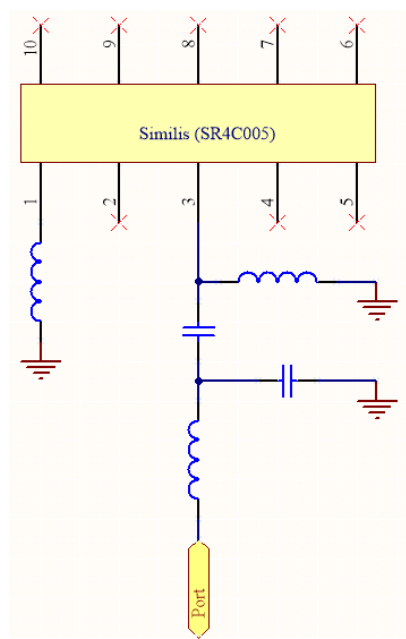

## 12.0 Antenna Integration Guide

### 12.1 Antenna Placement

Whichever the host PCB size used, the antenna should be placed ideally on the host PCB's shortest edge with the longest GND

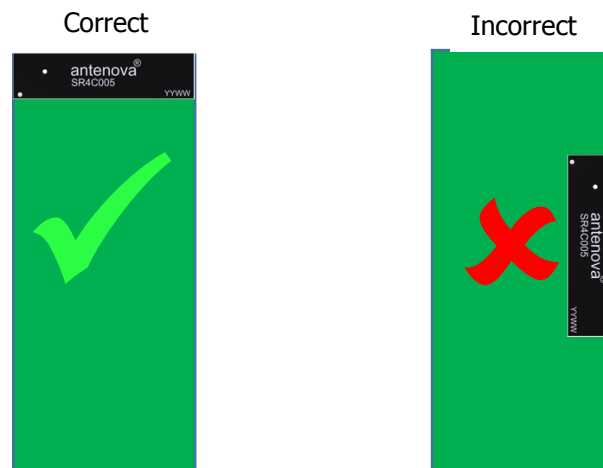

The antenna requires clearance ideally in 5 spatial directions as shown below. Where this cannot be achieved you should keep as many clear as possible to a minimum of 3. Please note performance will degrade with less clearances.

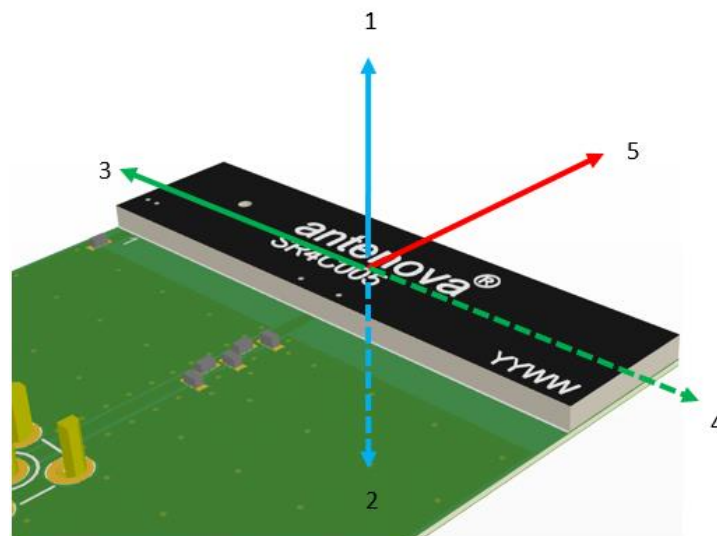

## 12.2 Host PCB Layout

The host PCB must ensure the footprint and clearance meets the antenna specification. An example of the PCB layout shows the antenna footprint with clearance.

Example host layout

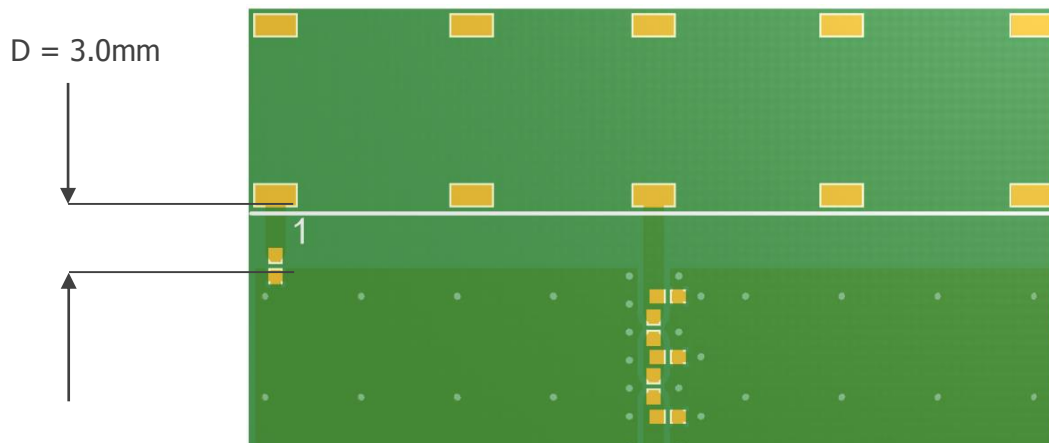

The distance D is the gap required from the antenna SMD pad edge to the ground plane. This should be maintained along the edge the antenna is placed.

## 12.3 Host PCB Clearance

Below shows the antenna footprint and clearance through all layers on the PCB. Only the antenna pads and connections to feed and GND are present within this clearance area.

Example host layout

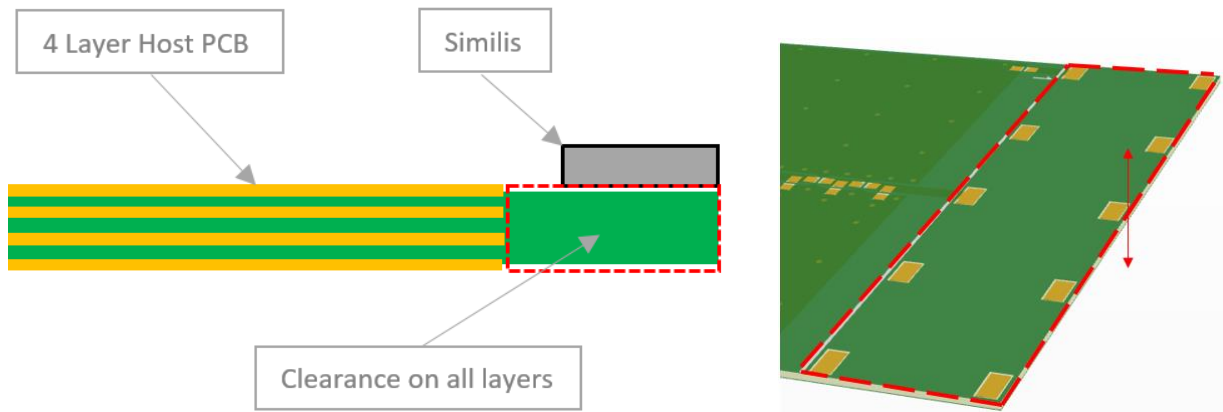

Placement of components and GND with traces adjacent to the antenna should maintain a minimum clearance of 15mm from either side. The antenna should be therefore placed in the corner to only have one side effected.

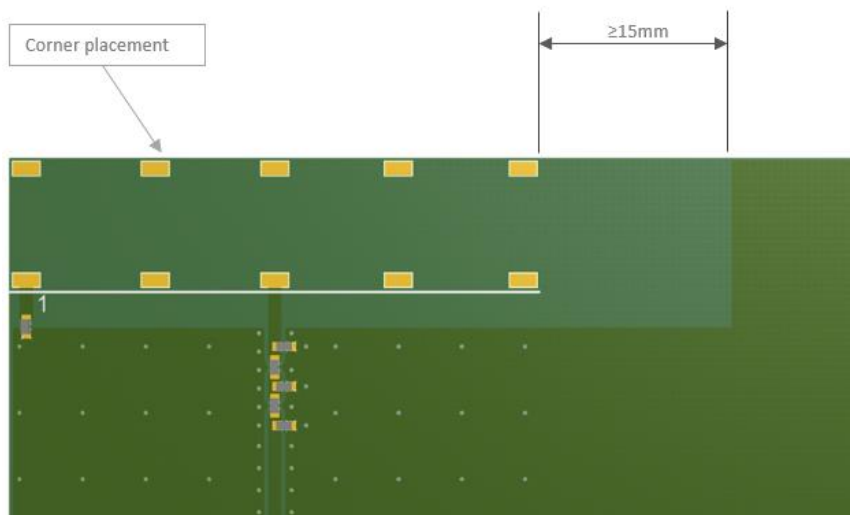

## 13.0 Host PCB Size

The performance of the low bands is highly dependent on the ground plane length. The host PCB ground needs to be as long as the device allows. Reducing the GND directly relates to the performance of the low bands. As shown below you can see the effect of the GND plane length vs the efficiency.

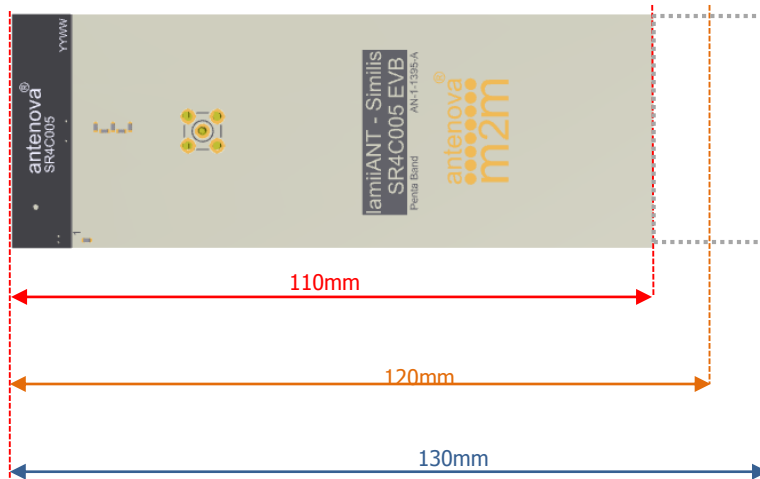

**Passive Efficiency vs. PCB length**  
*All results measured in Antenova's anechoic chamber*

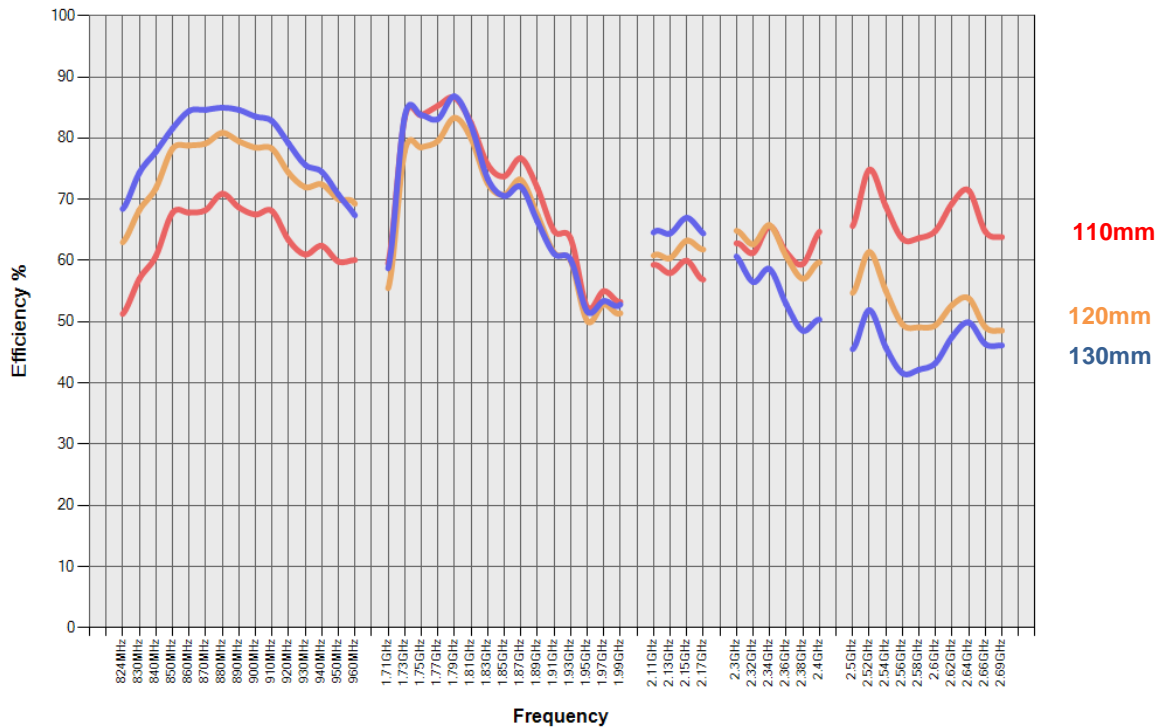



## 14.0 Reference Board

The reference board has been designed for evaluation purposes of SR4C005 includes a SMA female connector.

### SR4C005 Evaluation Board



To order a reference board contact [sales@antenna-m2m.com](mailto:sales@antenna-m2m.com).  
Please state if single or two antenna EVB is required.

## 14.1 Reference Board Matching Circuit

The reference board has been designed for evaluation purposes of SR4C005 includes a SMA female connector.

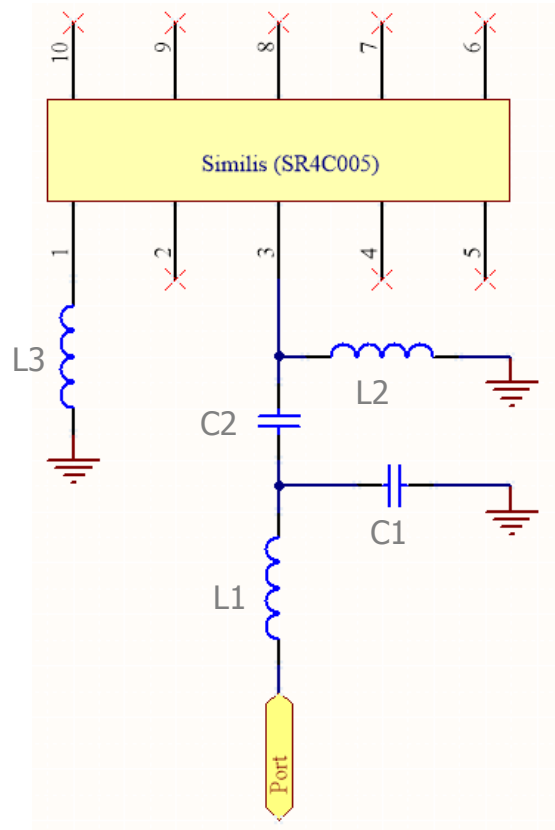

| Designator | Type       | Value      | Description           |
|------------|------------|------------|-----------------------|
| L1, L3     | Inductor   | 2.2nH      | Murata LQG15HN series |
| L2         | Not Fitted | Not Fitted | Not Fitted            |
| C1         | Not Fitted | Not Fitted | Not Fitted            |
| C2         | Capacitor  | 22pF       | Murata GJM15 series   |

## 15. Soldering

This antenna is suitable for lead free soldering. The reflow profile should be adjusted to suit the device, oven and solder paste, while observing the following conditions:

- The maximum temperature should not exceed 240 °C
- However for lead free soldering, a maximum temperature of 255 °C for no more than 20 seconds is permitted.
- The antenna should not be exposed to temperatures exceeding 120 °C more than 3 times during the soldering process.

## 16. Hazardous Material Regulation Conformance

The antenna has been tested to conform to RoHS requirements. A certificate of conformance is available from Antenova M2M's website.

## 17. Packaging

### 17.1 Optimal Storage Conditions

|               |                                                                             |
|---------------|-----------------------------------------------------------------------------|
| Temperature   | -10°C to 40°C                                                               |
| Humidity      | Less than 75% RH                                                            |
| Shelf life    | 24 Months                                                                   |
| Storage place | Away from corrosive gas and direct sunlight                                 |
| Packaging     | Reels should be stored in unopened sealed manufacturer's plastic packaging. |

**Note: Storage of open reels of antennas is not recommended due to possible oxidization of pads on antennas. If short term storage is necessary, then it is highly recommended that the bag containing the antenna reel is re-sealed and stored in like storage conditions as in above table.**

## 17.2 Tape Characteristics

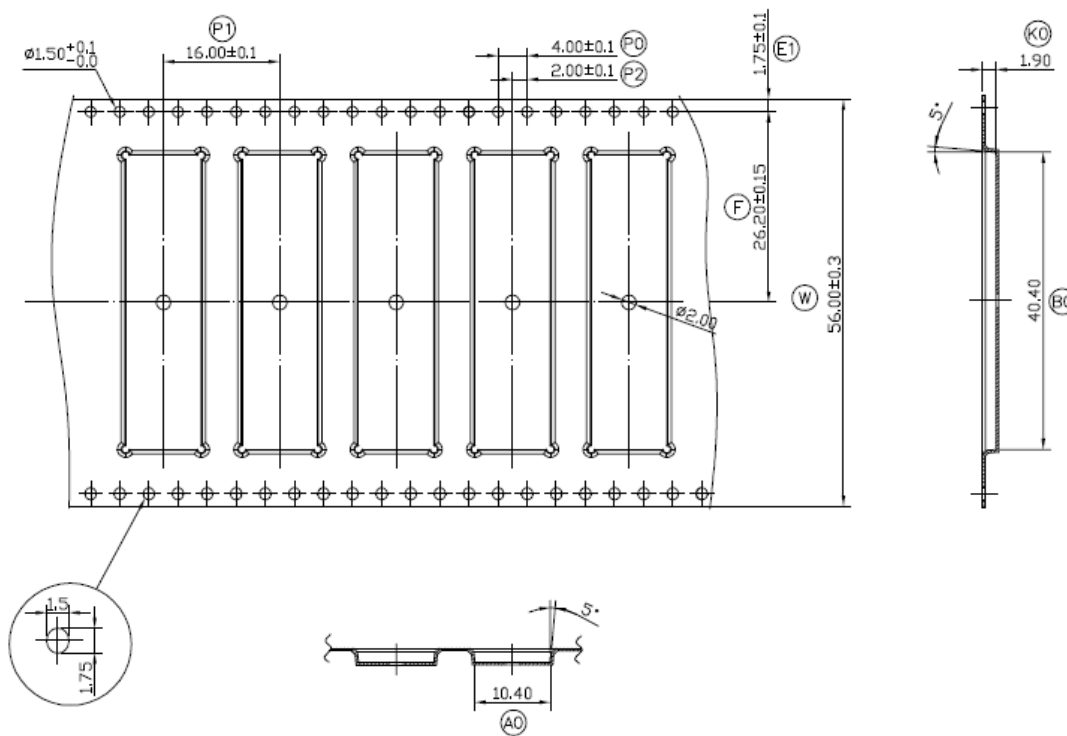

| Ko   | Ao          | Bo          | P0         | P1          | P2         |
|------|-------------|-------------|------------|-------------|------------|
| 1.90 | 10.40 ± 0.1 | 40.40 ± 0.1 | 4.00 ± 0.1 | 16.00 ± 0.1 | 2.00 ± 0.1 |

| E1         | F           | W           |
|------------|-------------|-------------|
| 1.75 ± 0.1 | 26.2 ± 0.15 | 56.00 ± 0.3 |

Dimensions in mm

### Notes:

- 1) Material: PS Black – Thickness: 0.35 ± 0.05.
- 2) Packaging length per 22" reel: 85 Meters (1:5).
- 3) Component load per 13" reel: 1000pcs

### 17.3 Reel Dimensions

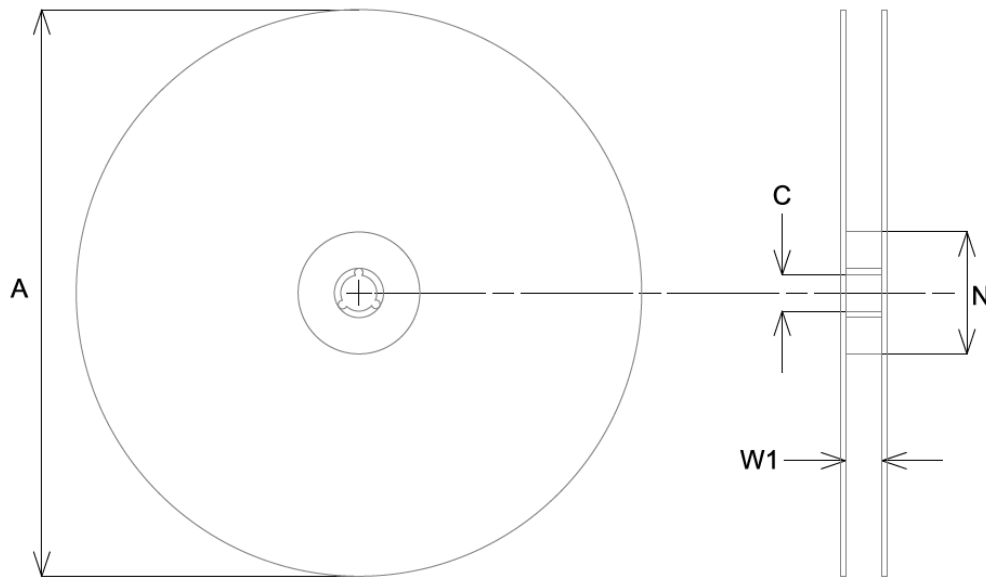

| A           | C          | N           | W1         |
|-------------|------------|-------------|------------|
| 330.0 ± 2.0 | 13.5 ± 0.5 | 100.0 ± 0.2 | 44.4 ± 0.3 |

All dimensions in mm

## 17.4 Box Dimensions

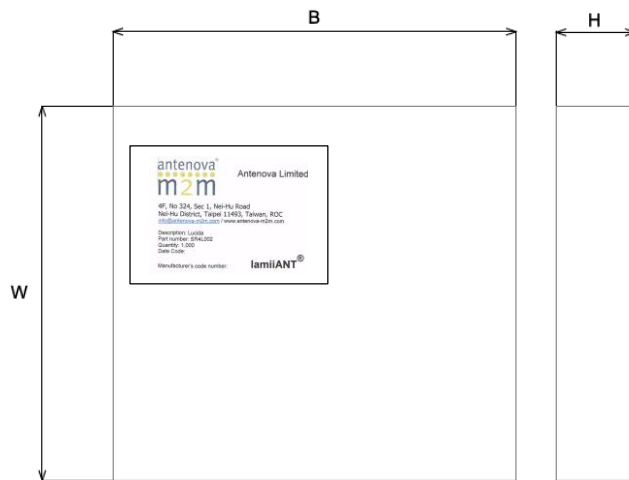

| Width (W) | Breadth (B) | Thickness (H) |
|-----------|-------------|---------------|
| 350mm     | 355mm       | 70mm          |

## 17.5 Bag Properties

Reels are supplied in protective plastic packaging.

## 17.6 Reel Label Information

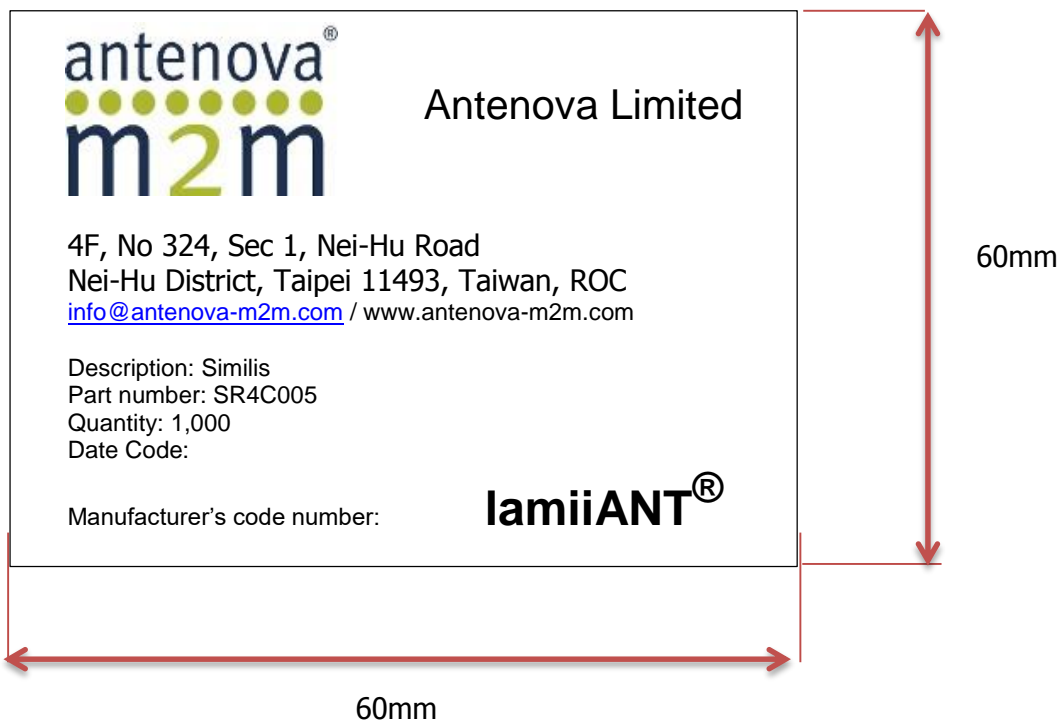



[www.antenova-m2m.com](http://www.antenova-m2m.com)

**Corporate Headquarters**

Antenova Limited  
2<sup>nd</sup> Floor Titan Court  
3 Bishop Square  
Hatfield  
AL10 9NA  
UK

**Tel:** +44 1233 810600

**Email:** [sales@antenova-m2m.com](mailto:sales@antenova-m2m.com)

**North America Headquarters**

Antenova Limited  
100 Brush Creek Road  
Suite 103, Santa Rosa  
California 95404,  
USA

**Tel:** +1 707 890 5202

**Email:** [sales@antenova-m2m.com](mailto:sales@antenova-m2m.com)

**Asia Headquarters**

Antenova Asia Limited  
4F, No. 324, Sec. 1, Nei-Hu Road  
Nei-Hu District  
Taipei 11493  
Taiwan, ROC

**Tel:** +886 (0) 2 8797 8630

**Fax:** +886 (0) 2 8797 6890

**Email:** [sales@antenova-m2m.com](mailto:sales@antenova-m2m.com)

**Copyright© Antenova Ltd.** All Rights Reserved. Antenova ®, Antenova M2M ®, gigaNOVA ® , the Antenova product family names, and the Antenova and Antenova M2M logos are trademarks and/or registered trademarks of Antenova Ltd. Any other names and/or trademarks belong to their respective companies.

The materials provided herein are believed to be reliable and correct at the time of printing. Antenova does not warrant the accuracy or completeness of the information, text, graphics or other items contained within this information. Antenova further assumes no responsibility for the use of this information, and all such information shall be entirely at the user's risk.



Certificate No: 4598

Antennas for Wireless M2M Applications

## X-ON Electronics

Largest Supplier of Electrical and Electronic Components

*Click to view similar products for [Antennas](#) category:*

*Click to view products by [Antenova](#) manufacturer:*

Other Similar products are found below :

[GAN30084EU](#) [930-033-R](#) [GW17.07.0250E](#) [1513563-1](#) [EXE902SM](#) [APAMPG-117](#) [MAF94383](#) [W3908B0100](#) [W6102B0100](#) [YE572113-30RSMM](#) [108-00014-50](#) [66089-2406](#) [SPDA17RP918](#) [A09-F8NF-M](#) [A09-F5NF-M](#) [RGFRA1903041A1T](#) [W3525BW100](#) [W3593B0100](#) [W3921B0100](#) [SIMNA-868](#) [SIMNA-915](#) [SIMNA-433](#) [W1044](#) [W1049B090](#) [A75-001](#) [WTL2449CQ1-FRSMM](#) [CPL9C](#) [EXB148BN](#) [0600-00060](#) [TRA9020S3PBN-001](#) [GD5W-28P-NF](#) [MA9-7N](#) [GD53-25](#) [GD5W-21P-NF](#) [EXB144SM](#) [C37](#) [MAF94051](#) [GD35-17P-NF](#) [P1744](#) [MA9-5N](#) [EXD420PL](#) [B1322NR](#) [QWFTB120](#) [MAF94271](#) [MAF94300](#) [GPSMB301](#) [FG4403](#) [AO-AGSM-OM54](#) [5200232](#) [MIKROE-2349](#)