

Beltii GNSS Antenna

Part No. SR4G013

lamiiANT[®]

Product Specification

1. Features

- Antenna for 1559 – 1609 MHz, GNSS for embedded applications
- Solution for all global public constellations: GPS, GLONASS, Beidou and GALILEO.
- Works over a ground plane. No clearance required.
- Ideal for wearables.
- Maintains high performance on device: DFI (Designed for Integration)
- SMD mounted
- Supplied on Tape and Reel

2. Description

Beltii is intended for use with GNSS applications. Designed for small ground planes and integrates into the corner with no GND clearance required. High resistance to detuning makes this antenna ideal for small wearable devices.

3. Applications

- Wearable devices
- Trackers
- Portable Devices
- Drones
- Navigation
- Sports tracking



4. Part Number

Beltii: SR4G013



5. General Data

Product name	Beltii
Part Number	SR4G013
Frequency	1559 - 1609 MHz
Polarization	Linear
Operating temperature	-40°C to 140°C
Impedance with matching	50 Ω
Weight	< 0.5 g
Antenna type	SMD
Dimensions	15.6 x 3.3 x 4.4 (mm)

6. RF Characteristics

	Typical performance	Conditions
Peak gain	2.3dBi	1559 – 1609 MHz frequency range All data measured on Antenna's evaluation PCB Part No. SR4G013-U1
Average gain	-2.3dBi	
Average efficiency	>60%	
Maximum return loss	<-8.0dB	
Maximum VSWR	2.2:1	

7. RF Performance

7.1 Return Loss

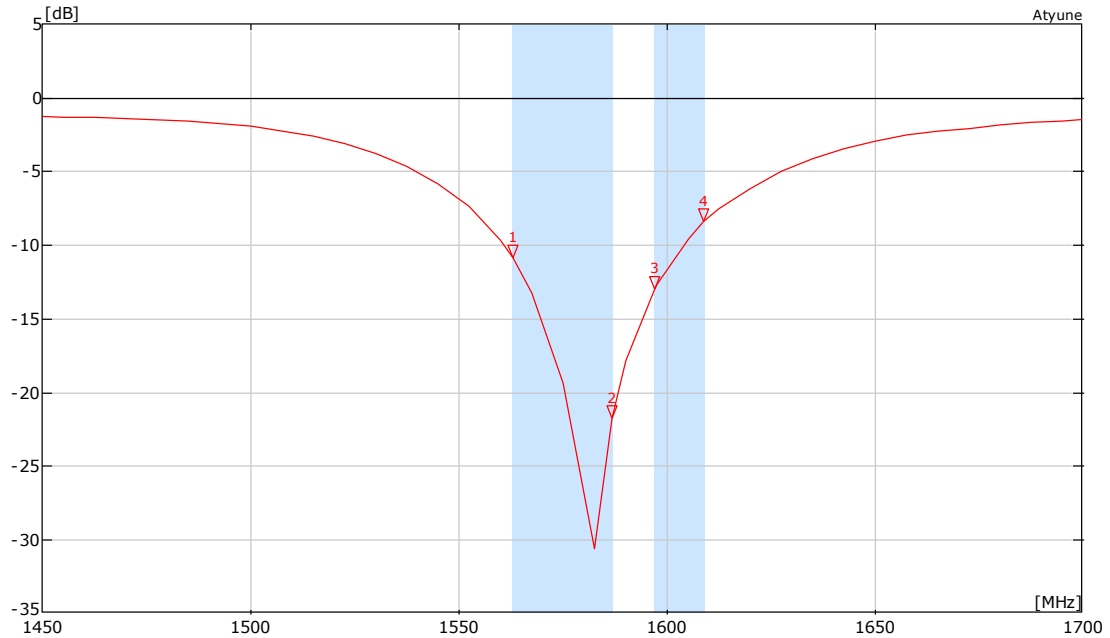

7.2 VSWR

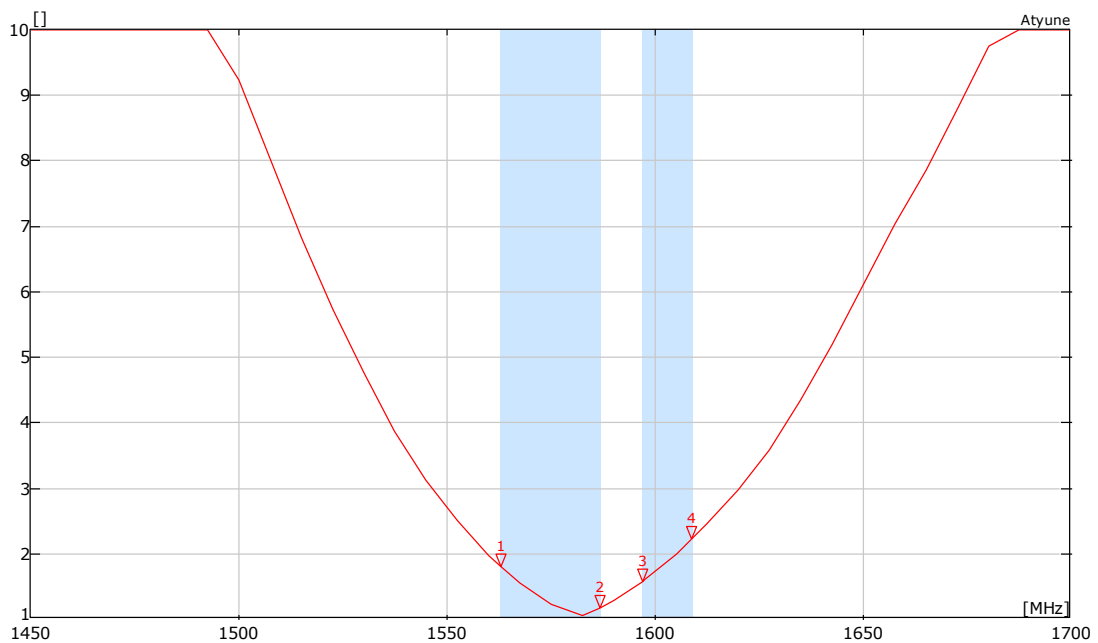

7.3 Antenna Radiation Pattern

7.3.1 1559 - 1609 MHz

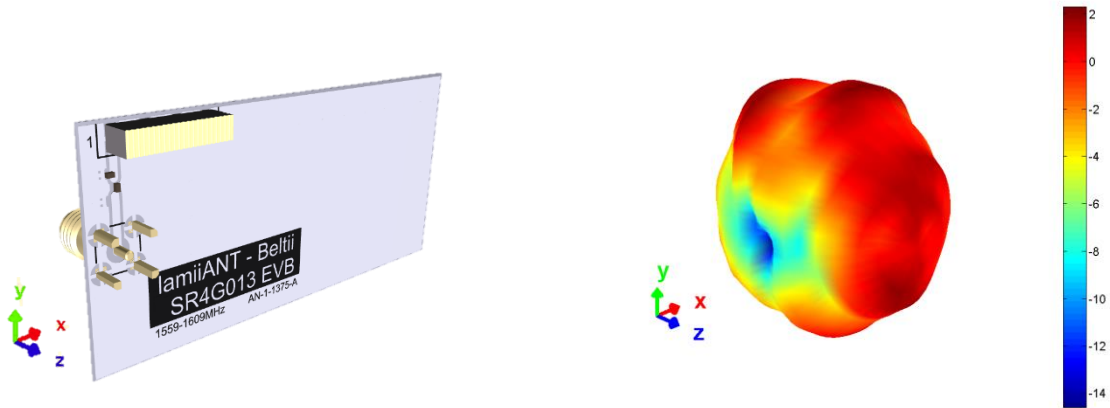

3D pattern at 1575.42MHz

Drag to rotate pattern and PCB by using Adobe Reader
(Click to Activate)

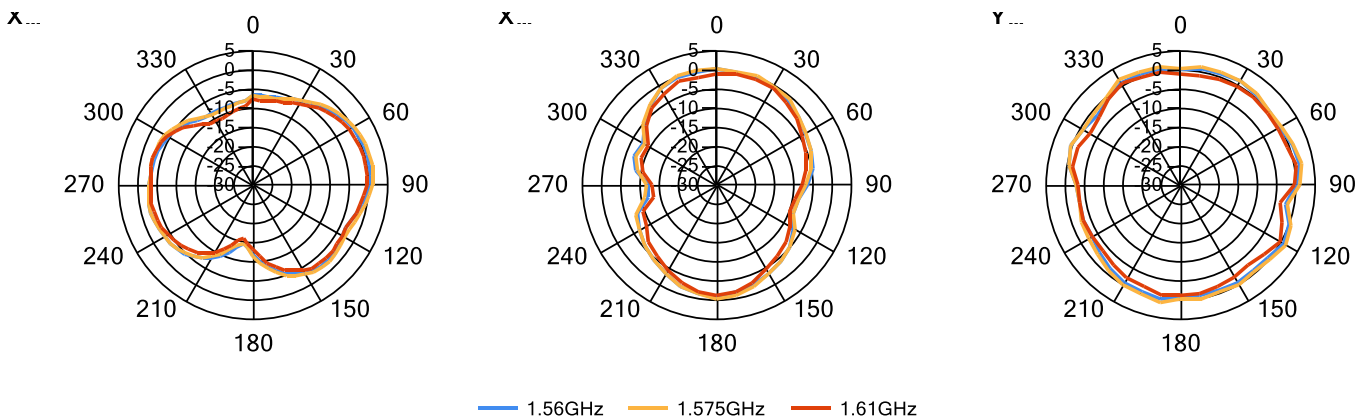

8. Antenna Dimensions

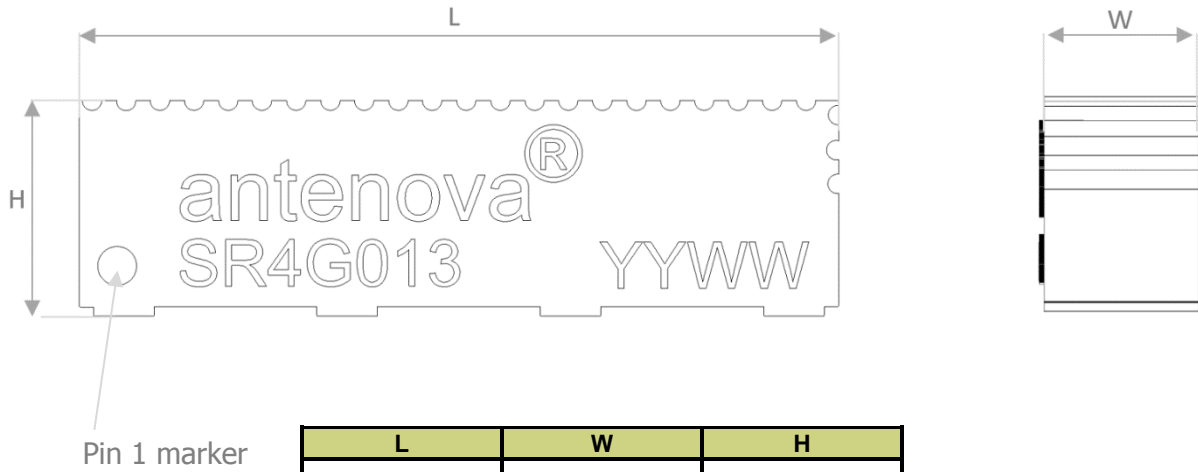

L	W	H
Length	Width	Height
15.6	3.3	4.4

All dimensions in mm

Bottom side dimensions

4 solder pads (3.2 x 1.2 mm)

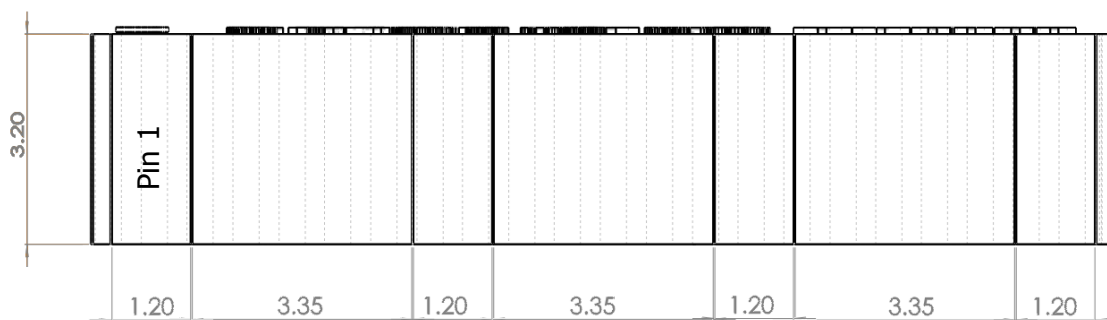

9.0 Antenna footprint

The recommended host PCB footprint is below.

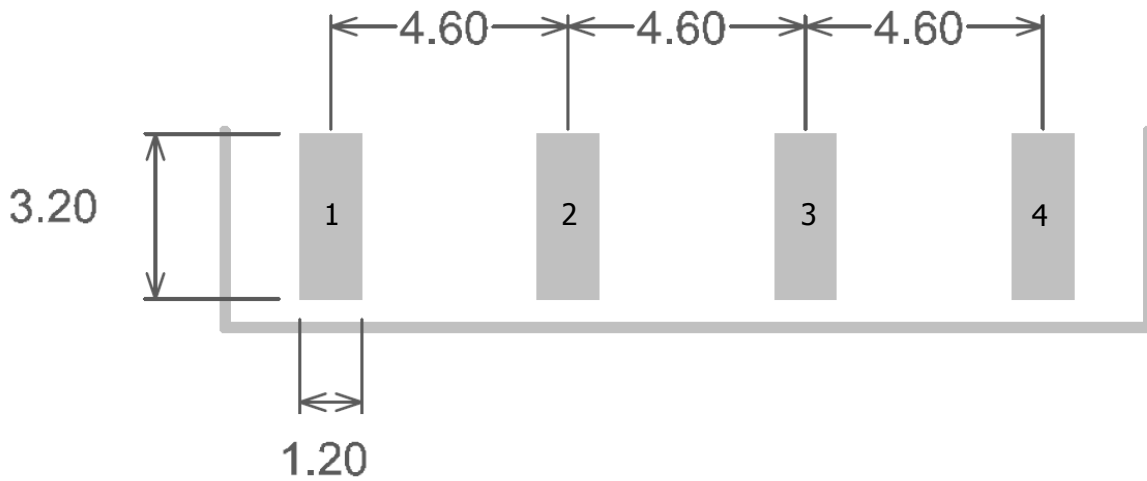

4 copper pads all 3.2 x 1.2 (mm)

10.0 Schematic

The circuit for the antenna and the matching components is below. The RF feed connection and GND connections are critical to the function of the antenna, and must be followed as shown.

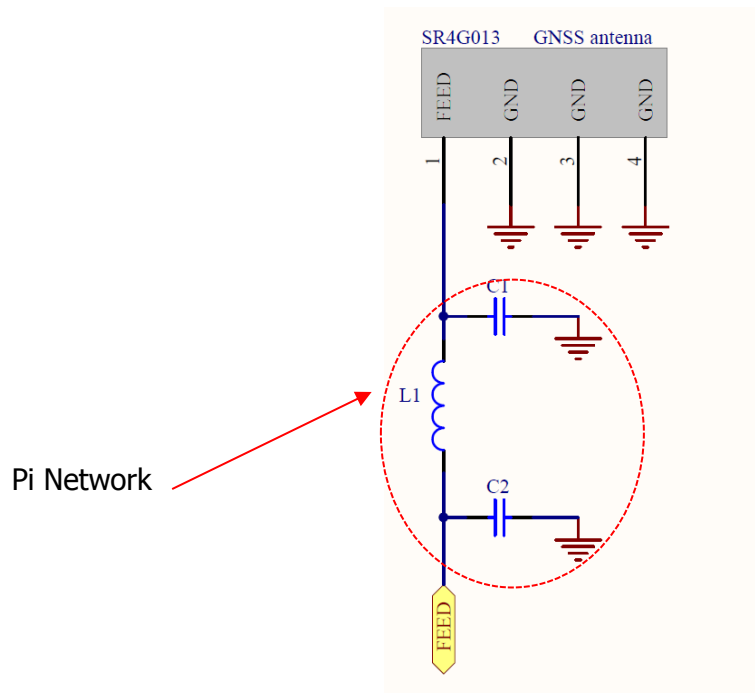

11. Electrical Interface

11.1 Transmission Line

All transmission lines should be designed to have a characteristic impedance of 50Ω.

- The length of the transmission lines should be kept to a minimum
- Any other parts of the RF system like transceivers, power amplifiers, etc, should also be designed to have an impedance of 50 Ω

Once the material for the PCB has been chosen (PCB thickness and dielectric constant), a coplanar transmission line can easily be designed using any of the commercial software packages for transmission line design. For the chosen PCB thickness, copper thickness and substrate dielectric constant, the program will calculate the appropriate transmission line width and gaps on either side of the feed.

11.2 Matching Circuit

The antenna requires a matching circuit that must be optimized for each product. The matching circuit will require up to three components and the following pad layout should be designed into the device so the correct circuit can be installed.

The Pi matching network must be placed close to the antenna feed to ensure it is more effective in tuning the antenna.

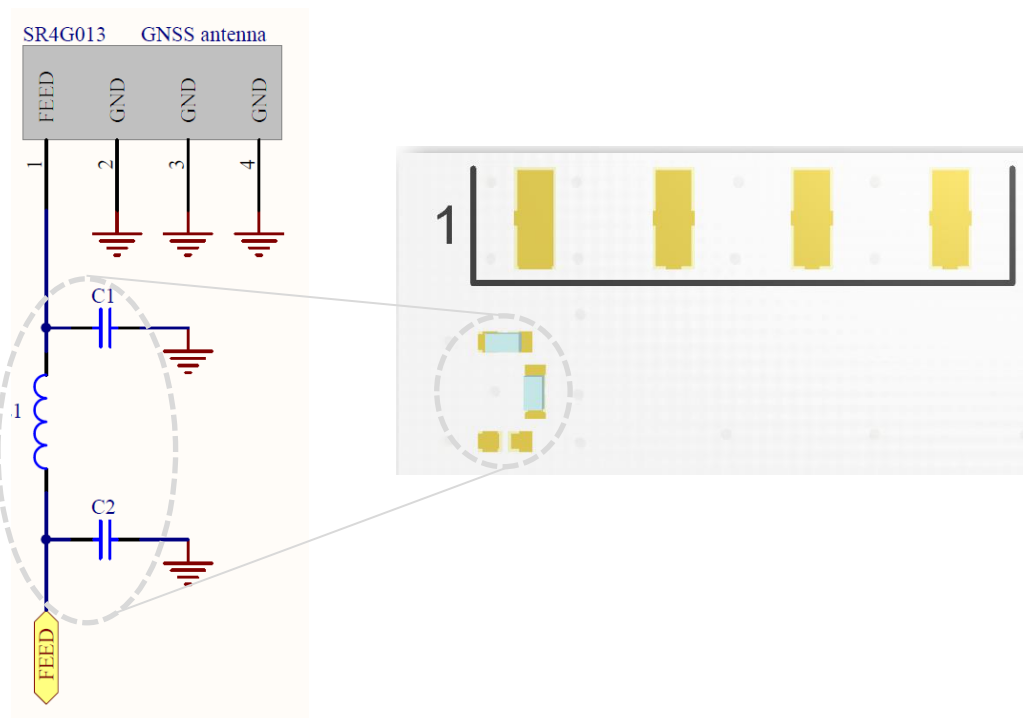

12.0 Antenna Integration Guide

12.1 Antenna Placement

Whichever size of host PCB is used, the antenna should be placed into the PCB corner. Ideally Pin 1 should be closest to the PCB edge.

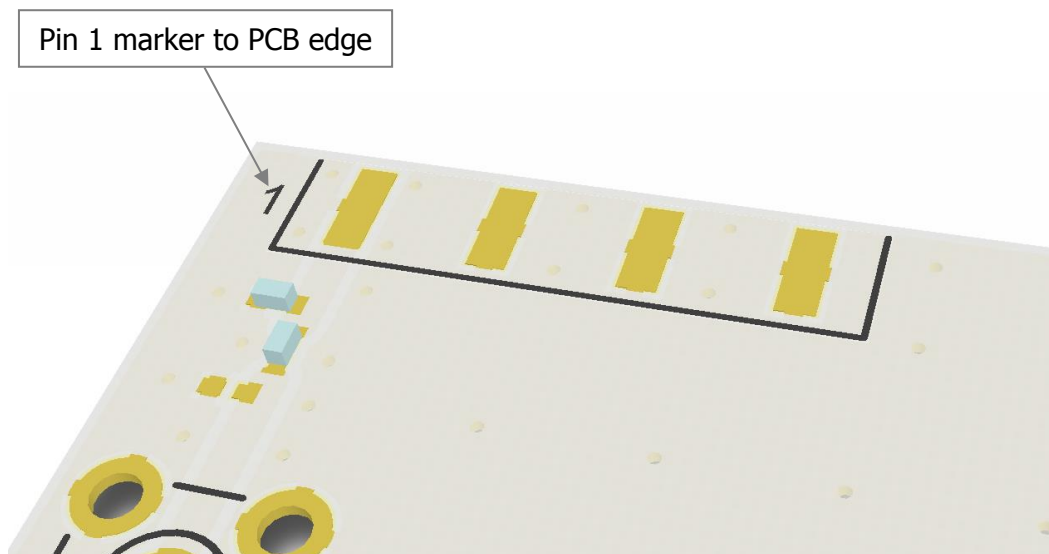

12.2 Host PCB Layout

The host PCB must ensure the footprint meets the antenna specification. An example of the PCB layout shows the antenna footprint. The antenna uses solder mask defined pads.

Example host layout

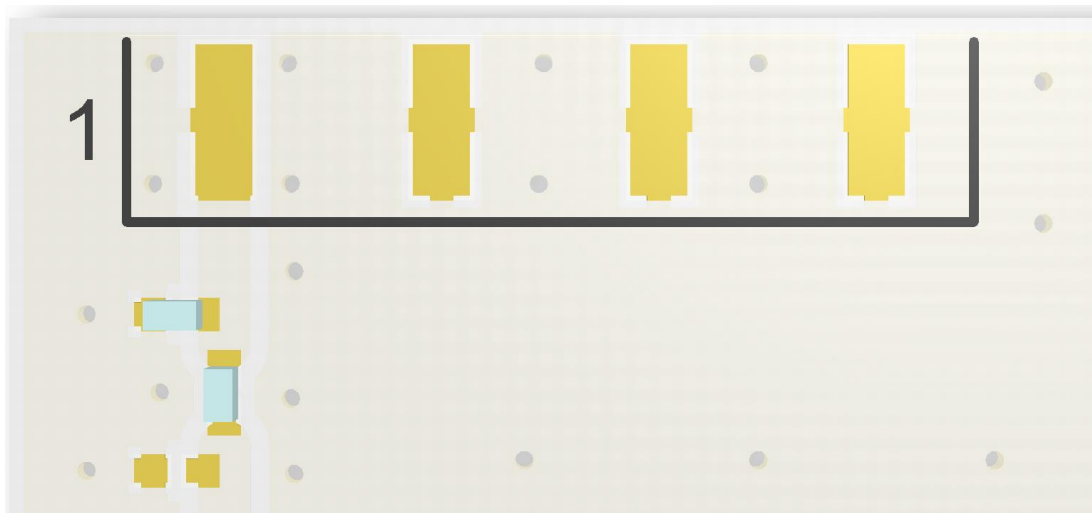

Below the footprint is shown again but without the solder mask. Pin 1 feed must be connected to GND as shown here.

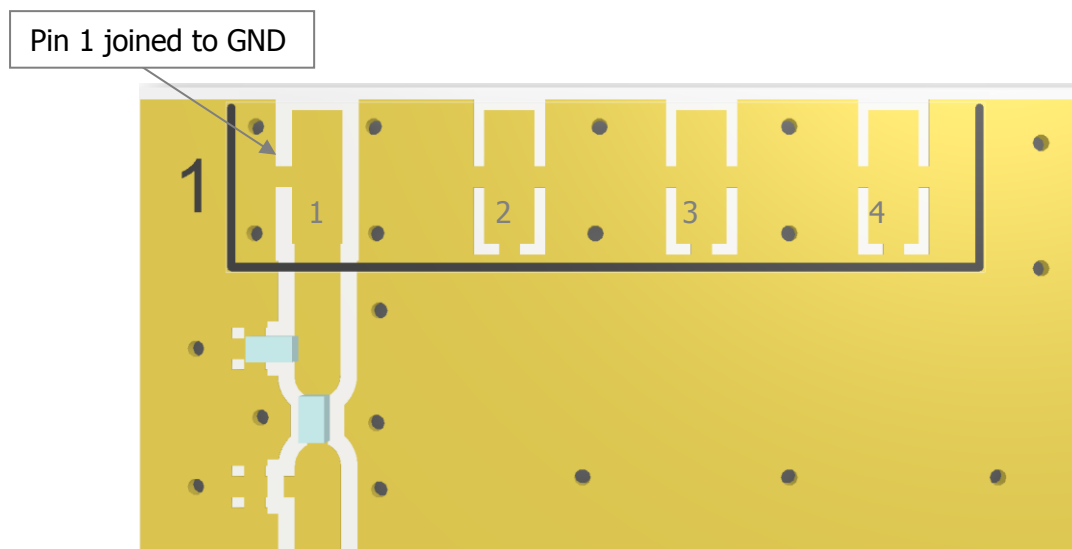

13.0 Reference Board

The reference board has been designed for evaluating the SR4G013, and includes an SMA female connector.

SR4G013-U1 Evaluation Board



To order a reference board contact sales@antenna-m2m.com

14. Soldering

This antenna is suitable for lead free soldering.

The reflow profile should be adjusted to suit the device, oven and solder paste, while observing the following conditions:

- The maximum temperature should not exceed 240 °C
- However, for lead free soldering, a maximum temperature of 255 °C for no more than 20 seconds is permitted.
- The antenna should not be exposed to temperatures exceeding 120 °C more than 3 times during the soldering process.

15. Hazardous Material Regulation Conformance

The antenna has been tested to conform to RoHS requirements. A certificate of conformance is available from Antenova M2M's website.

16. Packaging

16.1 Optimal Storage Conditions

Temperature	-10°C to 40°C
Humidity	Less than 75% RH
Shelf life	24 Months
Storage place	Away from corrosive gas and direct sunlight
Packaging	Reels should be stored in unopened sealed manufacturer's plastic packaging.

Note: Storage of open reels of antennas is not recommended due to possible oxidization of pads on antennas. If short term storage is necessary, then it is highly recommended that the bag containing the antenna reel is re-sealed and stored in like storage conditions as in above table.

16.2 Tape Characteristics

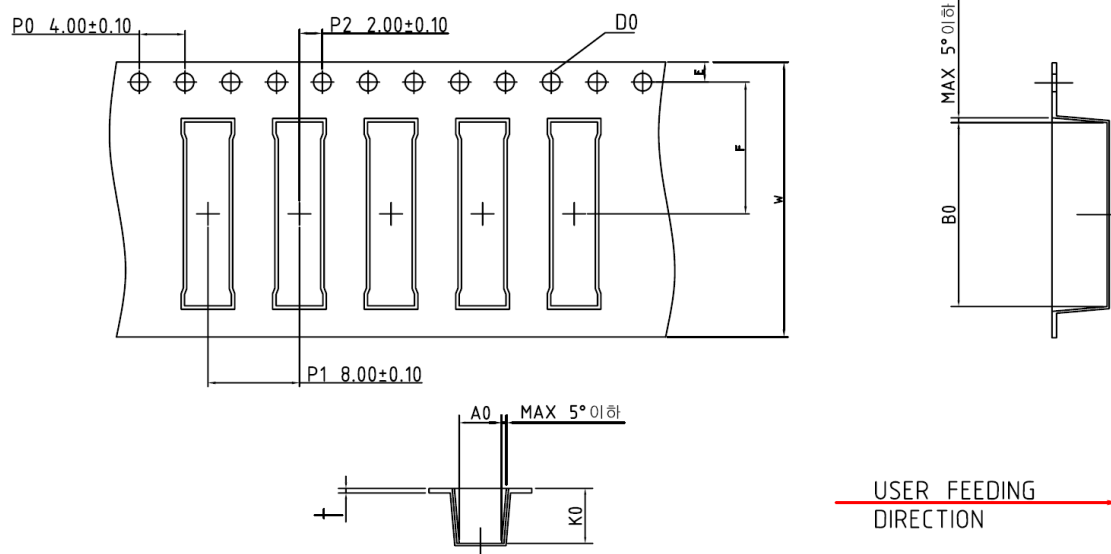

Do	Ao	Bo	P0	P1	P2
1.50 +0.1	3.70 ± 0.1	16.05 ± 0.1	4.00 ± 0.1	8.00 ± 0.1	2.00 ± 0.1

E	F	W	K0
1.75 ± 0.1	11.50 ± 0.1	24.00 ± 0.3	4.80 ± 0.1

Dimensions in mm

Notes:

- Sprocket hole pitch cumulative tolerance = ± 0.2 per 10
- Chamber not to exceed 1mm in 100mm
- Ao and Bo measured on a plane 0.1mm above the bottom of the pocket.
- K0 measured from a plane on the inside bottom of the pocket to the top surface of the carrier.

16.3 Reel Dimensions

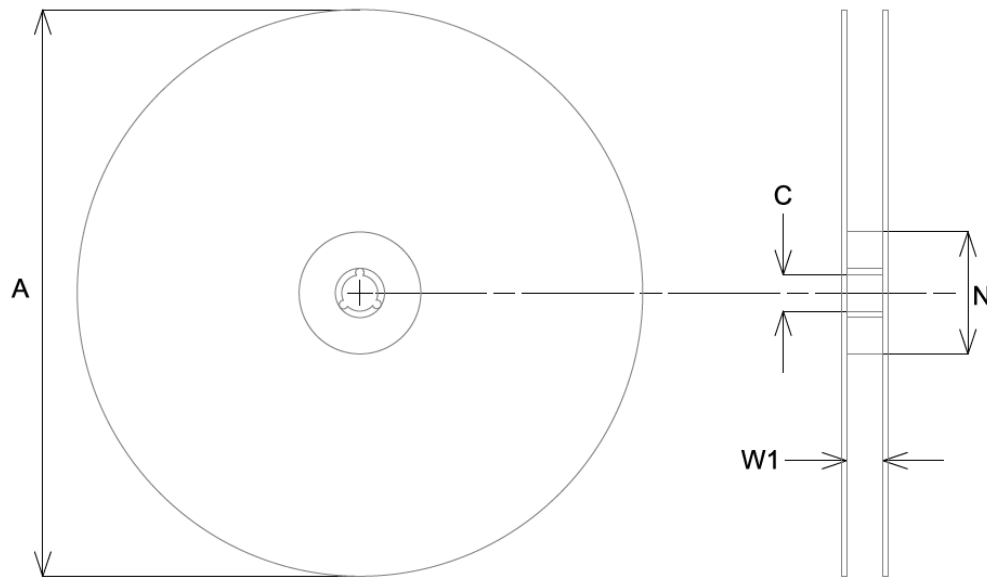

A	C	N	W1
330.0 ± 2.0	14.0 ± 0.5	80.0	32.0

All dimensions in mm

Quantity	Leading Space	Trailing Space
1000 pcs / reel	16 blank holders	24 blank holders

16.4 Box Dimensions

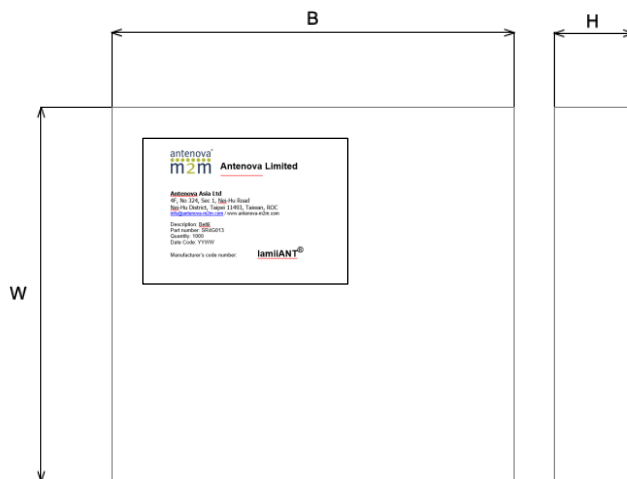

Width (W)	Breadth (B)	Thickness (H)
203mm	188mm	40mm

16.5 Bag Properties

Reels are supplied in protective plastic packaging.

16.6 Reel Label Information

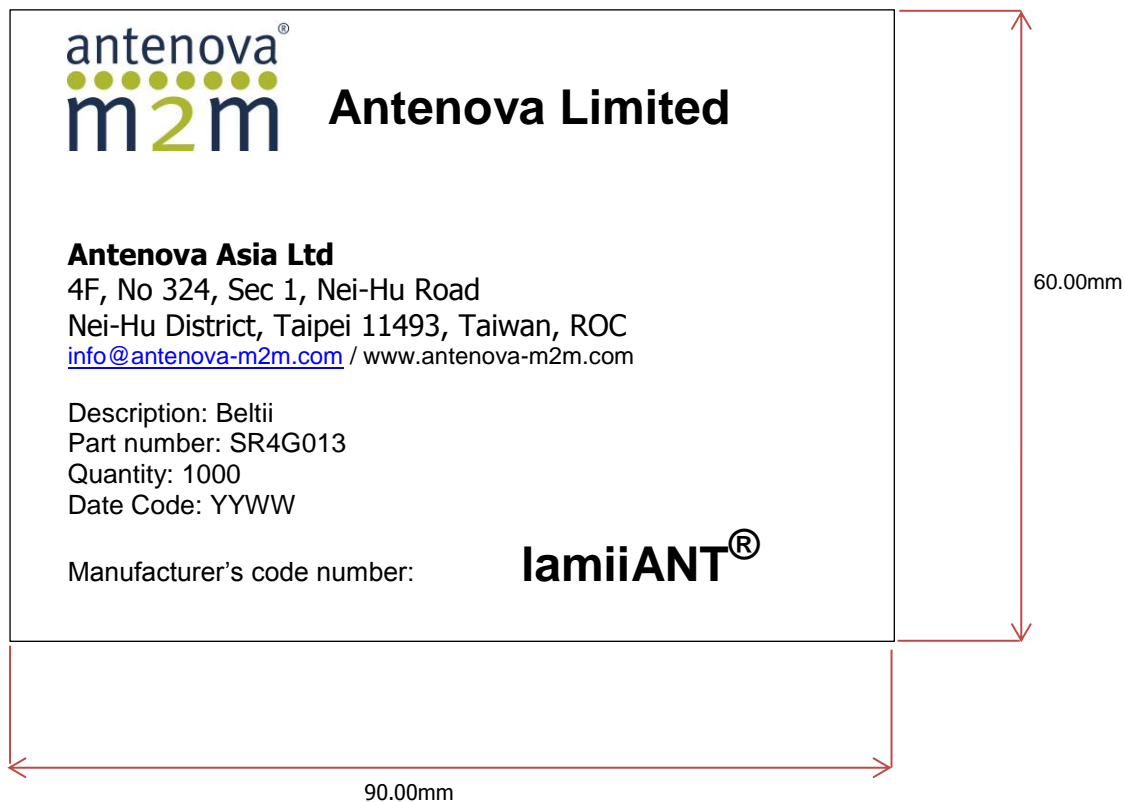



www.antenova-m2m.com

Corporate Headquarters

Antenova Limited
2nd Floor Titan Court
3 Bishop Square
Hatfield
AL10 9NA
UK

Tel: +44 1233 810600

Email: sales@antenova-m2m.com

North America Headquarters

Antenova Limited
100 Brush Creek Road, Suite 103
Santa Rosa
California
CA 95404

Tel: +1 707 890 5202

Email: sales@antenova-m2m.com

Asia Headquarters

Antenova Asia Limited
4F, No. 324, Sec. 1, Nei-Hu Road
Nei-Hu District
Taipei 11493
Taiwan, ROC

Tel: +886 (0) 2 8797 8630

Fax: +886 (0) 2 8797 6890

Email: sales@antenova-m2m.com

Copyright© Antenova Ltd. All Rights Reserved. Antenova®, Antenova M2M®, gigaNOVA® the Antenova product family names and the Antenova and Antenova M2M logos are trademarks and/or registered trademarks of Antenova Ltd. Any other names and/or trademarks belong to their respective companies.

The materials provided herein are believed to be reliable and correct at the time of printing. Antenova does not warrant the accuracy or completeness of the information, text, graphics or other items contained within this information. Antenova further assumes no responsibility for the use of this information, and all such information shall be entirely at the user's risk.



Certificate No: 4598

Antennas for Wireless M2M Applications

X-ON Electronics

Largest Supplier of Electrical and Electronic Components

Click to view similar products for [Antenna Development Tools](#) category:

Click to view products by [Antenova](#) manufacturer:

Other Similar products are found below :

[0868AT43A0020-EB1SMA](#) [EVALBGSA141MN10TOBO1](#) [A10393-U1](#) [PCSD.06.A](#) [B5771-U1](#) [KIT-LTE-GNSS-01](#) [KIT-WIFI-ISM-01](#)
[A10472-U1](#) [REFLECTOR-EVB-1](#) [A10340-U1](#) [ACAG0201-2450-EVB](#) [ACAG0301-15752450-EVB](#) [ACAG0301-1575-EVB](#) [ACAG0301-24505500-EVB](#) [ACAG0301-5500-EVB](#) [ACAG0801-2450-EVB](#) [ACAG1204-433-EVB](#) [ACAG1204-868-EVB](#) [ACAG1204-915-EVB](#)
[ACAR0301-SW2-EVB](#) [ACAR3005-C2WB-EVB](#) [ACAR3005-S824-EVB](#) [ACAR3705-S698-EVB](#) [ACAR4008-S698-EVB](#) [A10137-D](#)
[A10194-U1](#) [A10204-U1](#) [A5645H-EVB-1](#) [A5645-U1](#) [A5887H-EVB-1](#) [A6111-U1](#) [M20057-EVB-1](#) [SR42W001-U1](#) [SR42W009-U1](#)
[SR4G008-U1](#) [SR4G013-U1](#) [SR4G053-EVB-1](#) [SR4L049-EVB-1](#) [SRC5G027-U1](#) [SRCW004-U1](#) [1001312-01](#) [M310220-01](#) [M620720-01](#)
[M830120-01](#) [M830520-01](#) [EB_NN01-105A](#) [EB_NN02-201-5G](#) [CCKLTE450-NA](#) [AEK-GNCP-TH258L15](#) [MPA-104- KIT](#)