

1. Features

- Antenna for ISM 868 and 915 MHz applications.
- Frequency bands from 863- 928MHz
- Maintains high performance on device: DFI (Designed for Integration)
- Low profile innovative design.
- SMD mounting
- Supplied in Tape and Reel
- Automotive temperature rating

2. Description

Velox uses a ground plane on the host PCB to radiate effectively. The antenna itself requires a clearance underneath. An external matching circuit is used to optimise the antenna within a device to the required bands. Designed specifically for 868/915 ISM applications that require a small robust solution.

3. Applications

- Industrial/Scientific/Medical (ISM)
- Remote monitoring/ Smart meters
- Network Devices
- Manufacturing automation
- Agriculture/Environment
- Consumer tracking



4. Part Number

Velox: SR4I052



5. General Data

Product name	Velox
Part Number	SR4I052
Frequency	863 – 928MHz
Polarization	Linear
Environmental Condition Test	ISO16750-4 5.1.1.1/5.1.2.1/5.3.2
Operating temperature	-40°C to140°C
Impedance with matching	50 Ω
Weight	< 2g
Antenna type	SMD
Dimensions	35.0 x 8.0 x 0.9 (mm)

6. RF Characteristics

	863 – 928 MHz
Peak gain	1.60dBi
Average gain (Linear)	-1.60dBi
Average efficiency	>70%
Maximum return loss	<-7.5dB
Maximum VSWR	2.4:1

All data measured on Antenna's evaluation PCB
Part No. SR4I052-EVB-1

7. RF Performance

The performance is shown for the frequency range 863-928MHz.

7.1 Return Loss

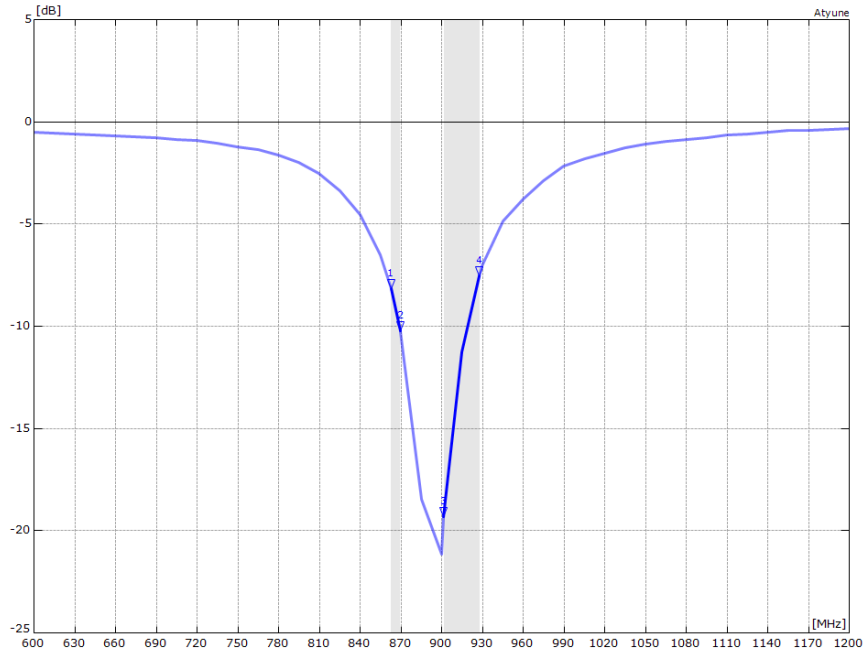

7.2 VSWR

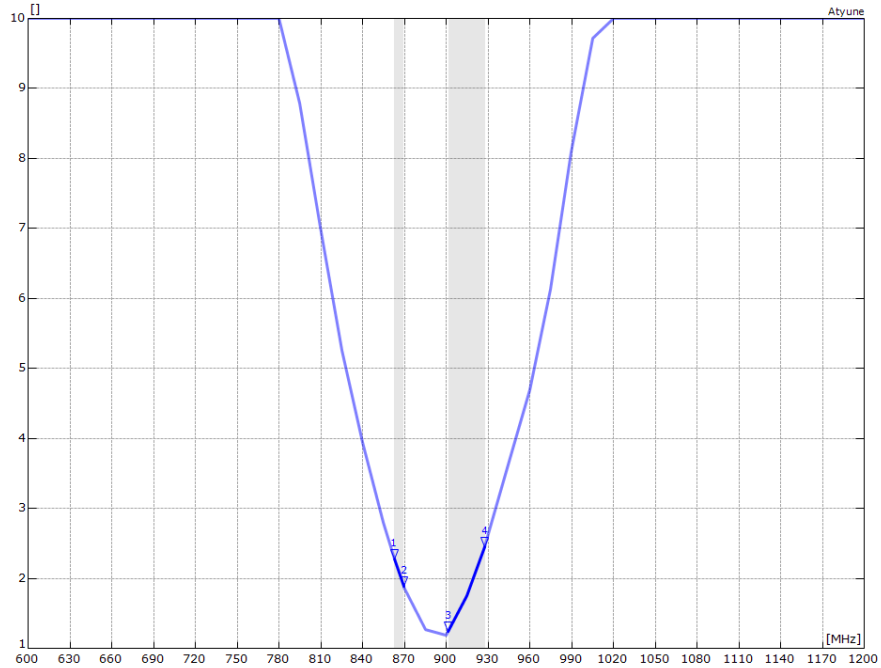

7.3 Antenna pattern

7.3.1 863 – 928 MHz

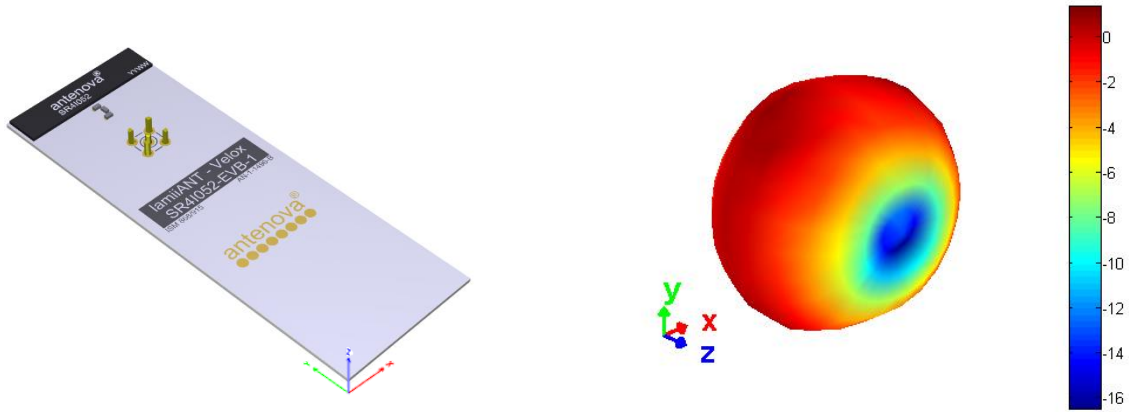

3D pattern at 902 MHz
*Drag to rotate pattern and PCB by using Adobe Reader
(Click to Activate)*

XY

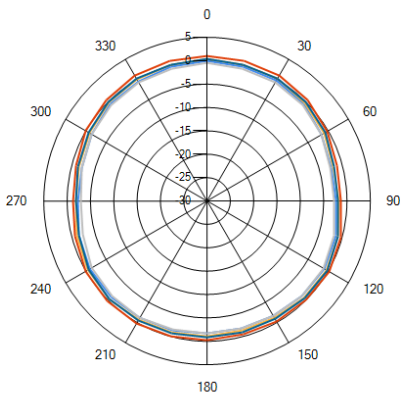

XZ

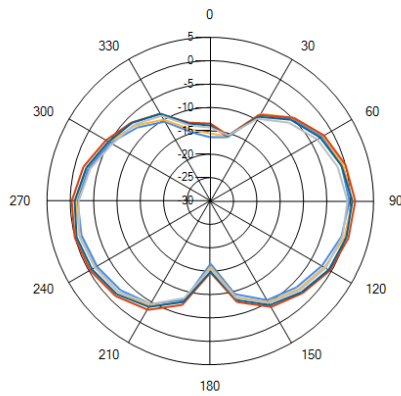

YZ

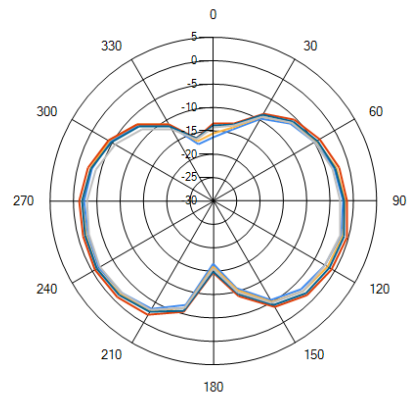

— 864MHz — 870MHz — 902MHz — 916MHz — 928MHz

8. Antenna Dimensions

Velox: SR4I052

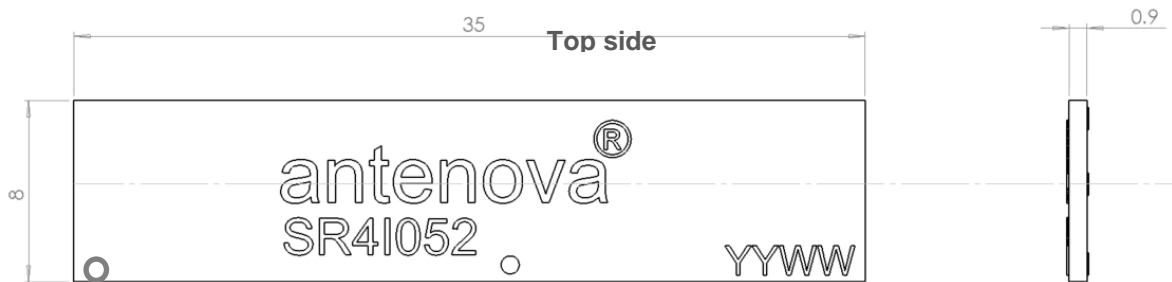

L	W	H
Length	Width	Height
35.0 ±0.5	8.0 ±0.1	0.9 +0.1 -0.0

All Dimensions in (mm)

Bottom Side

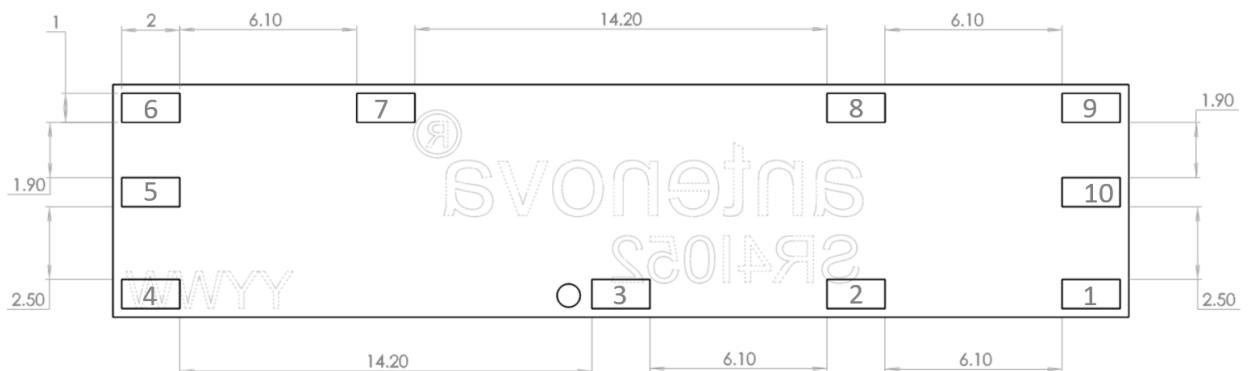

SMD pads 1-10 = 2.0 x 1.0 (mm)

All Dimensions in (mm)

Antennas for Wireless Applications

9.0 Schematic symbol and Pin definition

The circuit symbol for the antenna is shown below. The antenna has 10 pins with only Pin 3 as functional. All other pins are for mechanical strength only.

Pin	Description
3	Feed
1,2,4,5,6,7,8,9,10	Not connected

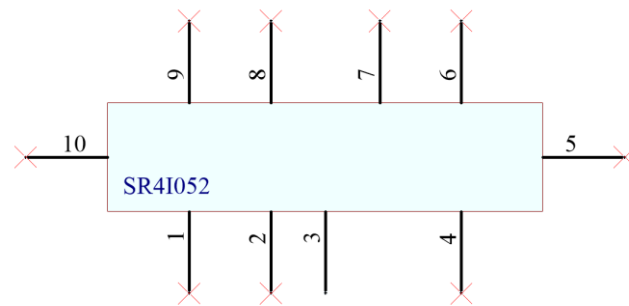

10.0 Antenna footprint

The recommended host PCB footprint is below.

Velox: SR4I052

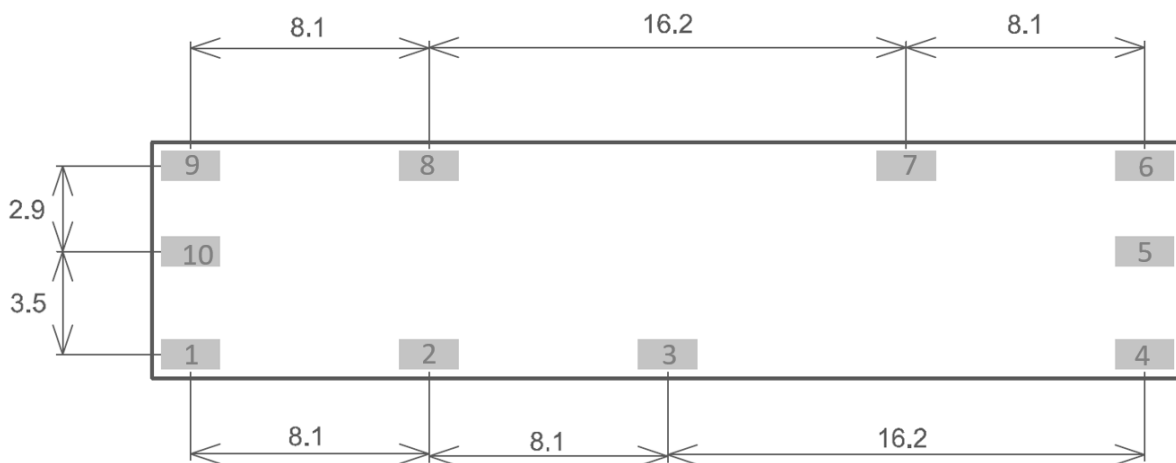

10 SMD pads all 2.0 x 1.0 (mm)
All Dimensions in mm

11. Electrical Interface

11.1 Transmission Line

All transmission lines should be designed to have a characteristic impedance of 50Ω.

- The length of the transmission lines should be kept to a minimum
- Any other parts of the RF system like transceivers, power amplifiers, etc, should also be designed to have an impedance of 50 Ω

Once the material for the PCB has been chosen (PCB thickness and dielectric constant), a coplanar transmission line can easily be designed using any of the commercial software packages for transmission line design. For the chosen PCB thickness, copper thickness and substrate dielectric constant, the program will calculate the appropriate transmission line width and gaps on either side of the track so the characteristic impedance of the co-planar transmission is 50 Ω.

11.2 Matching Circuit

The antenna requires a matching circuit that must be optimized for each product. The matching circuit will require up to five components and the following circuit should be designed into the host PCB. Not all components may be required but should be included as a precaution. The matching network must be placed close to the antenna feed to ensure it is more effective in tuning the antenna.

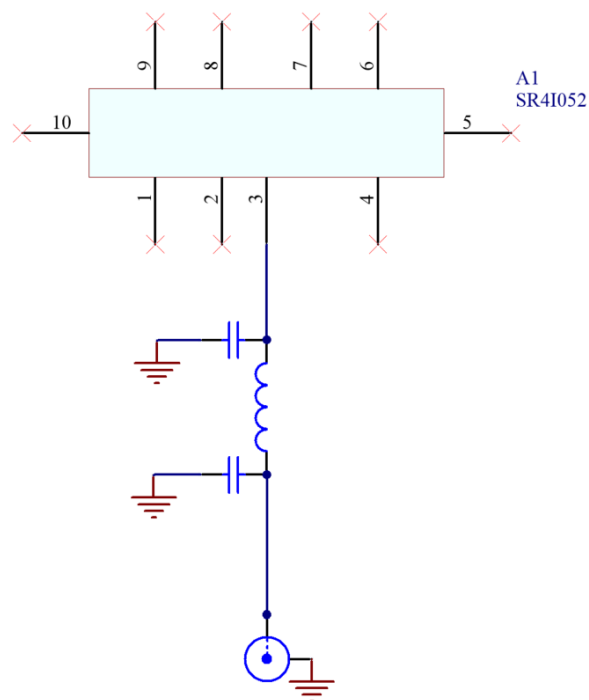

12.0 Antenna Integration Guide

12.1 Antenna Placement

Whatever the size of the host PCB, the antenna should ideally be placed on the shortest side of the host PCB.



12.2 Host PCB Layout

On the host PCB, the footprint and clearance must meet the antenna specification. An example of the PCB layout shows the antenna footprint with clearance. The feed (Pin 3) connects to the matching circuit close to the antenna.

Example host layout

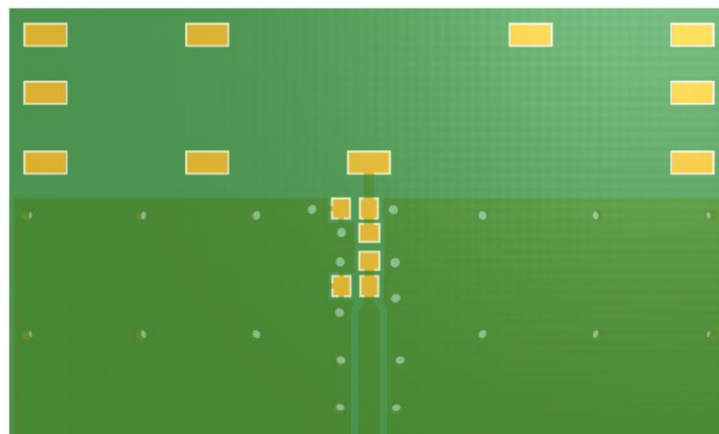

12.3 Host PCB Clearance

The diagram below shows the antenna footprint and clearance through all layers on the PCB. Only the antenna pads and connections to feed are present within this clearance area. The clearance area required is 35.0 x 9.0 (mm). The solder mask is removed to show this more clearly.

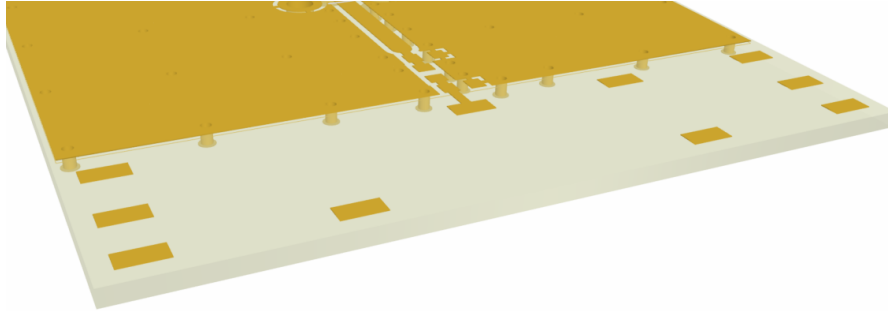

The clear-out area is simply defined as the same size as the antenna, with a 1mm additional clearance below the antenna to the GND.

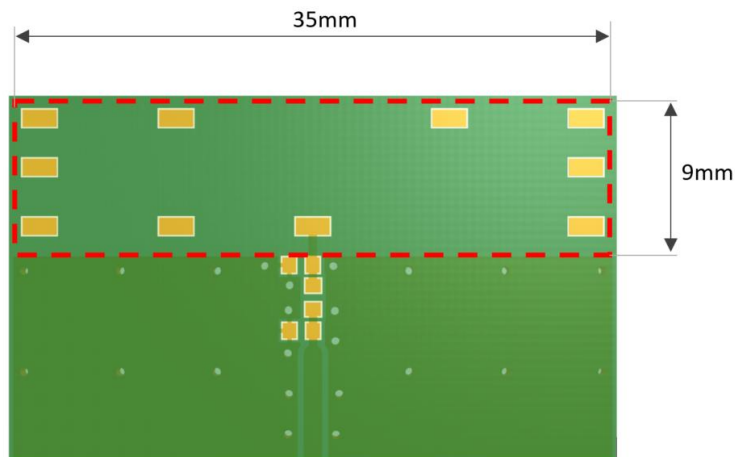
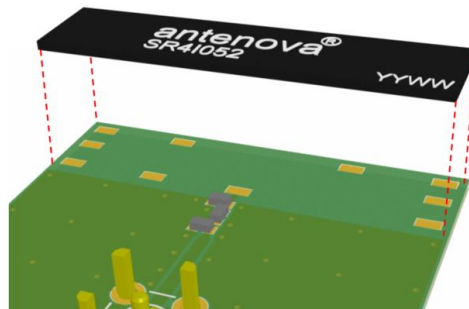

----- Clearance area

13.0 Reference Board

The reference board has been designed for the purpose of evaluating the SR4I052 antenna and includes a SMA female connector.

SR4I052-EVB-1 Evaluation Board



To order a reference board please see www.antenna.com

13.1 Reference Board Matching Circuit

The reference board has been designed for the purpose of evaluating the SR4I052 antenna and includes a SMA female connector.

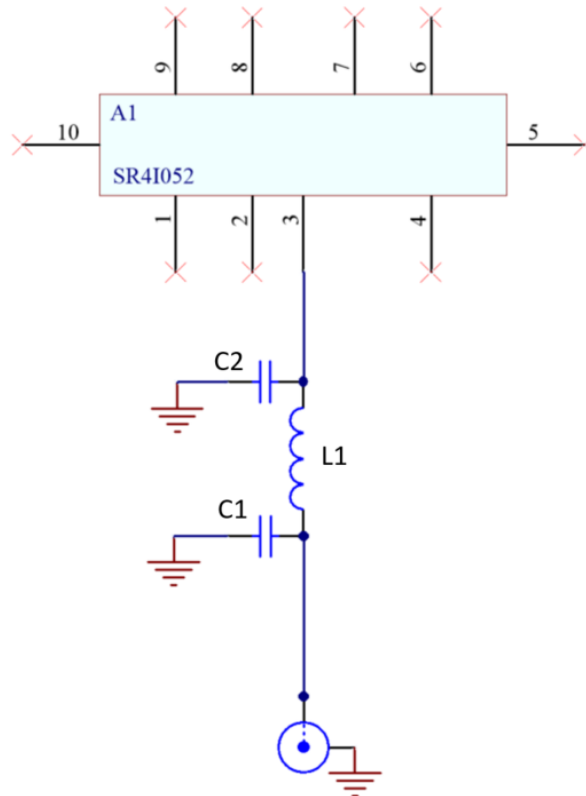

EVB-1 Matching SR4I052-EVB-1

Designator	Type	Value	Description
C1	Capacitor	3.9pF	Murata GJM15HN series
C2	Capacitor	DNP	Not Fitted
L1	Inductor	4.3nH	Murata LQG15 series

14. Soldering

This antenna is suitable for lead free soldering.

The reflow profile should be adjusted to suit the device, oven and solder paste, while observing the following conditions:

- The maximum temperature should not exceed 240 °C
- However for lead free soldering, a maximum temperature of 255 °C for no more than 20 seconds is permitted.
- The antenna should not be exposed to temperatures exceeding 120 °C more than 3 times during the soldering process.

15. Hazardous Material Regulation Conformance

The antenna has been tested to conform to RoHS requirements. A certificate of conformance is available from Antenova's website.

16. Packaging

16.1 Optimal Storage Conditions

Temperature	-10°C to 40°C
Humidity	Less than 75% RH
Shelf life	24 Months
Storage place	Away from corrosive gas and direct sunlight
Packaging	Reels should be stored in unopened sealed manufacturer's plastic packaging.

Note: Storage of open reels of antennas is not recommended due to possible oxidization of pads on antennas. If short term storage is necessary, then it is highly recommended that the bag containing the antenna reel is re-sealed and stored in like storage conditions as in above table.

16.2 Tape Characteristics

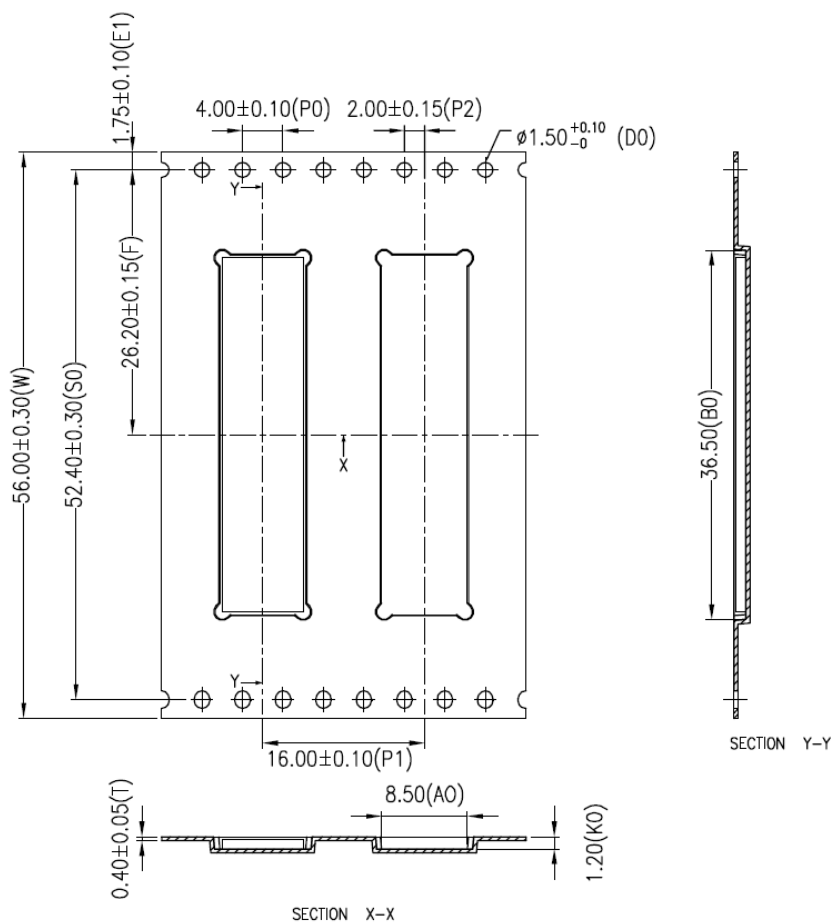

Ko	Ao	Bo	P0	P1	P2
1.20	8.5 ± 0.1	36.5 ± 0.1	4.00 ± 0.1	16.00 ± 0.1	2.00 ± 0.1

E1	F	W
1.75 ± 0.1	26.2 ± 0.15	56.00 ± 0.3

Dimensions in mm

Notes:

- 1) 10 sprocket hole pitch cumulative tolerance ± 0.2 mm.
- 2) Camber not to exceed 1mm in 100mm.
- 3) Ao and Bo measured on a plane 0.1mm above the bottom of the packet.
- 4) Ko measured from a plane on the inside bottom of the packet to the top surface carrier.

16.3 Reel Dimensions

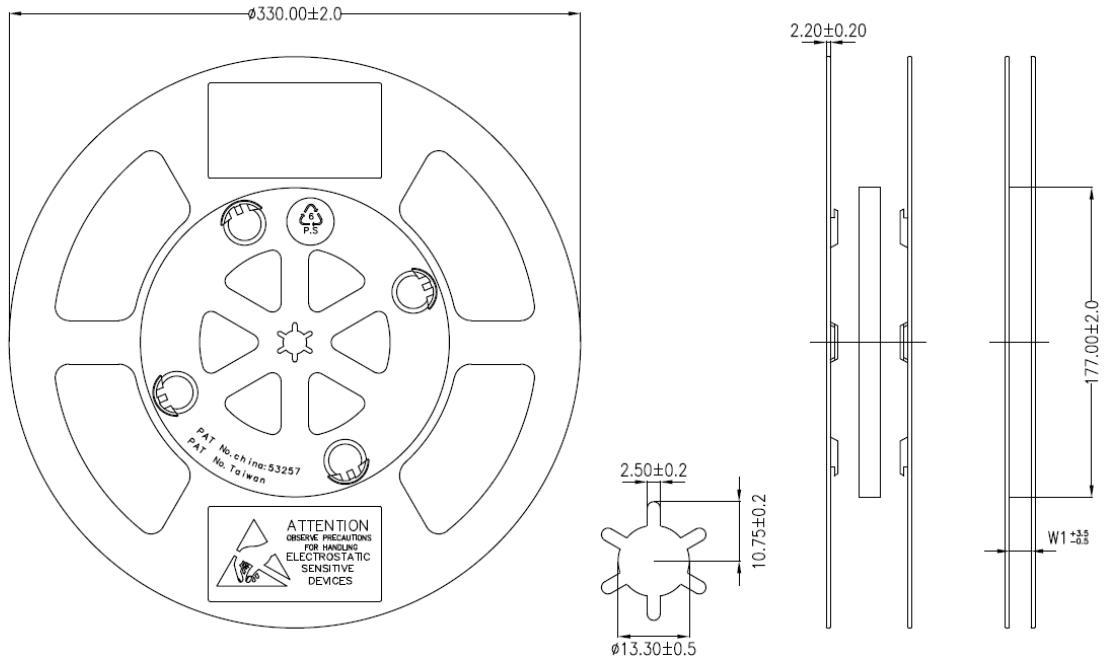

A	W1
330.0 ± 2.0	56.5 ± 0.3

All dimensions in mm

16.4 Box Dimensions

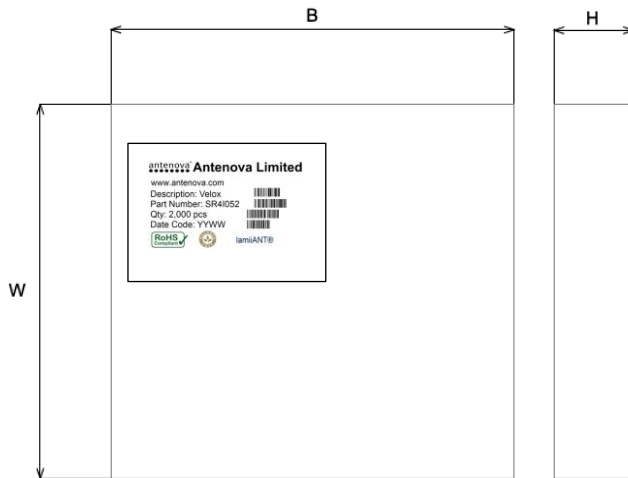

Width (W)	Breadth (B)	Thickness (H)
358mm	350mm	73mm

16.5 Bag Properties

Reels are supplied in protective plastic packaging.

16.6 Reel Label Information



Quality statements

Antenova's products conform to REACH and RoHS legislation. For our statements regarding these and other quality standards, please see www.antenova.com.



Antenna design, integration and test resources

Product designers – the details contained in this datasheet will help you to complete your embedded antenna design. Please follow our technical advice carefully to obtain optimum antenna performance.

It is our goal that every customer will create a high performing wireless product using Antenova's antennas. You will find a wealth of design resources, calculators and case studies to aid your design at our website.

Antenova's design laboratories are equipped with the latest antenna design tools and test chambers. We provide antenna design, test and technical integration services to help you complete your design and obtain certifications.

If you cannot find the antenna you require in our product range, please contact us to discuss creating a bespoke antenna to meet your requirement exactly.

Contacts

Join our online antenna design community: ask.antenova.com

Order antenna samples and evaluation boards at: www.antenova.com

Request a quotation for antennas by volume: sales@antenova.com

Global Headquarters:

**Antenova Ltd, 2nd Floor Titan Court, 3 Bishop Square,
Hatfield, AL10 9NA +44 (0) 1223 810600**

Copyright® Antenova Ltd. All Rights Reserved. Antenova®, gigaNOVA®, RADIONOVA®, the Antenova product family names and the Antenova logos are trademarks and/or registered trademarks of Antenova Ltd. Any other names and/or trademarks belong to their respective companies. The materials provided herein are believed to be reliable and correct at the time of printing. Antenova does not warrant the accuracy or completeness of the information, text, graphics or other items contained within this information. Antenova further assumes no responsibility for the use of this information, and all such information shall be entirely at the user's risk.

Antennas for Wireless Applications

X-ON Electronics

Largest Supplier of Electrical and Electronic Components

Click to view similar products for [Antenna Development Tools](#) category:

Click to view products by [Antenova](#) manufacturer:

Other Similar products are found below :

[PCSD.06.A](#) [KIT-WIFI-ISM-01](#) [W3006-K](#) [AEK-433-SP](#) [AEK-403-SP](#) [74889100TB](#) [A10393-U1](#) [A10192-U1](#) [DTAD.01.A.50](#) [AEK-LTE-CER](#) [W3011A-K](#) [W3010-K](#) [W3008C-K](#) [LORA-K](#) [ISM-K](#) [A10472-U1](#) [REFLECTOR-EVB-1](#) [A10340-U1](#) [ACAG0201-2450-EVB](#) [ACAG0301-15752450-EVB](#) [ACAG0301-1575-EVB](#) [ACAG0301-24505500-EVB](#) [ACAG0301-5500-EVB](#) [ACAG0801-2450-EVB](#) [ACAG1204-433-EVB](#) [ACAG1204-868-EVB](#) [ACAG1204-915-EVB](#) [ACAR0301-SW2-EVB](#) [ACAR3005-C2WB-EVB](#) [ACAR3005-S824-EVB](#) [ACAR3705-S698-EVB](#) [ACAR4008-S698-EVB](#) [A10194-U1](#) [A5645H-EVB-1](#) [A6111-U1](#) [B5771-U1](#) [M20047-EVB-1](#) [M20071-EVB-1](#) [SR42W001-U1](#) [SR42W009-U1](#) [SR4G013-U1](#) [SR4G053-EVB-1](#) [SRC5G027-U1](#) [1001312-01](#) [M310220-01](#) [M620720-01](#) [M830120-01](#) [M830520-01](#) [P822601-01](#) [P822602-01](#)