

Curta

SR4L096 · lamiiANT[®]



Features

- Antenna for 4G and 3G applications
- Placement on short edge of PCB.
- LTE, GSM, CDMA, DCS, PCS, WCDMA, UMTS, HSPDA, GPRS, EDGE, IMT
- Bands: 698-960MHz; 1710-2170MHz; 2300-2400MHz; 2500-2700MHz
- SMD mounted device supplied on Tape and Reel
- Automotive temperature rating
- Compact 40 x 10 x 1.7mm
- Ideal for MIMO system

Contents

| | | |
|--------------|--|-----------|
| 1. | Description | 2 |
| 2. | Applications | 2 |
| 3. | General data | 2 |
| 4. | Part number | 3 |
| 5. | RF characteristics | 3 |
| 6. | RF performance | 4 |
| 6.1. | Return loss | 4 |
| 6.2. | VSWR | 4 |
| 6.3. | Efficiency | 5 |
| 6.4. | Antenna pattern | 6 |
| 7. | Antenna dimensions | 11 |
| 8. | Schematic symbol and pin definition | 12 |
| 9. | Host PCB footprint | 12 |
| 10. | Electrical interface | 13 |
| 10.1. | Transmission line | 13 |
| 10.2. | Matching circuit | 13 |
| 11. | Antenna integration guide | 14 |
| 11.1. | Antenna placement | 14 |
| 11.2. | Host PCB layout | 15 |
| 11.3. | Host PCB clearance | 16 |
| 12. | Reference board | 18 |
| 12.1. | Reference board matching circuit | 18 |
| 13. | Soldering | 19 |
| 14. | Hazardous material regulation conformance | 19 |
| 15. | Packaging | 19 |
| 15.1. | Optimal storage conditions | 19 |
| 15.2. | Tape characteristics | 20 |
| 15.3. | Reel dimensions | 21 |
| 15.4. | Box dimensions | 21 |
| 15.5. | Bag properties | 22 |
| 15.6. | Reel label information | 22 |

1. Description

Curta is intended for use with 4G/3G applications. This antenna is placed on the short edge of the host PCB and is designed for coexistence requirements, it can be integrated as a single antenna or in a MIMO system. This product specification gives the antenna performance over all stated frequency ranges.

2. Applications

- OBD2 vehicle tracking systems
- 4G Routers
- Medical equipment
- Tablets and Industrial systems
- MIMO Systems
- Femtocell / Picocell networks
- IoT sensor networks

3. General data

| | |
|------------------------------|--|
| FREQUENCY | 698-960MHz 1710-2170MHz 2300-2400MHz 2500-2700MHz |
| POLARIZATION | Linear |
| OPERATING TEMPERATURE | -40°C to 140°C |
| ENVIRONMENTAL CONDITION TEST | ISO16750-4 5.1.1.1/5.1.2.1/5.3.2 |
| IMPEDANCE WITH MATCHING | 50 Ω |
| WEIGHT | <1.5g |
| ANTENNA TYPE | SMD |
| DIMENSIONS | 40.0 x 10.0 x 1.7 (mm) |

4. Part number

CURTA
SR4L096



5. RF characteristics

| FREQUENCY | 698-960MHZ | 1710-2170MHZ | 2300-2400MHZ | 2500-2700MHZ |
|-----------------------|------------|--------------|--------------|--------------|
| PEAK GAIN | 2.1dBi | 3.8dBi | 3.8dBi | 2.7dBi |
| AVERAGE GAIN (LINEAR) | -2.5dB | -1.7dB | -2.8dB | -2.7dB |
| AVERAGE EFFICIENCY | 56% | 66% | 52% | 53% |
| MAXIMUM RETURN LOSS | -5.1dB | -5.2dB | -9.7dB | -4.9dB |
| MAXIMUM VSWR | 3.5:1 | 3.3:1 | 1.9:1 | 3.5:1 |

All data measured on Antenna's evaluation PCB Part
No. SR4L096-EVB-1

6. RF performance

6.1. Return loss

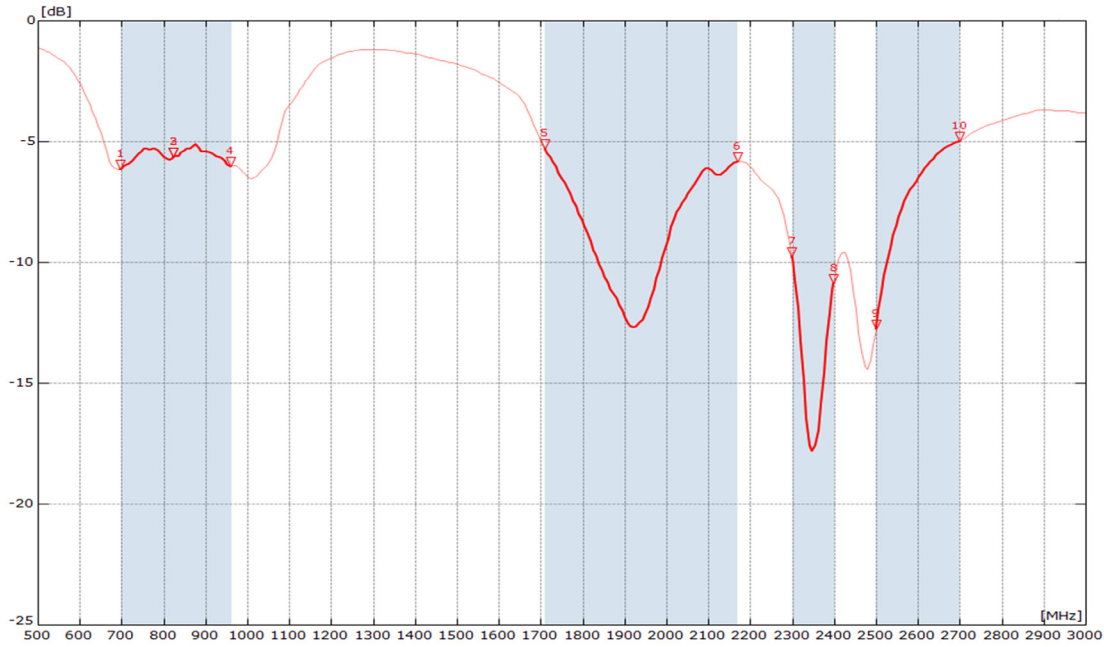

All data measured on Antenova's evaluation PCB Part
No. SR4L096-EVB-1

6.2. VSWR

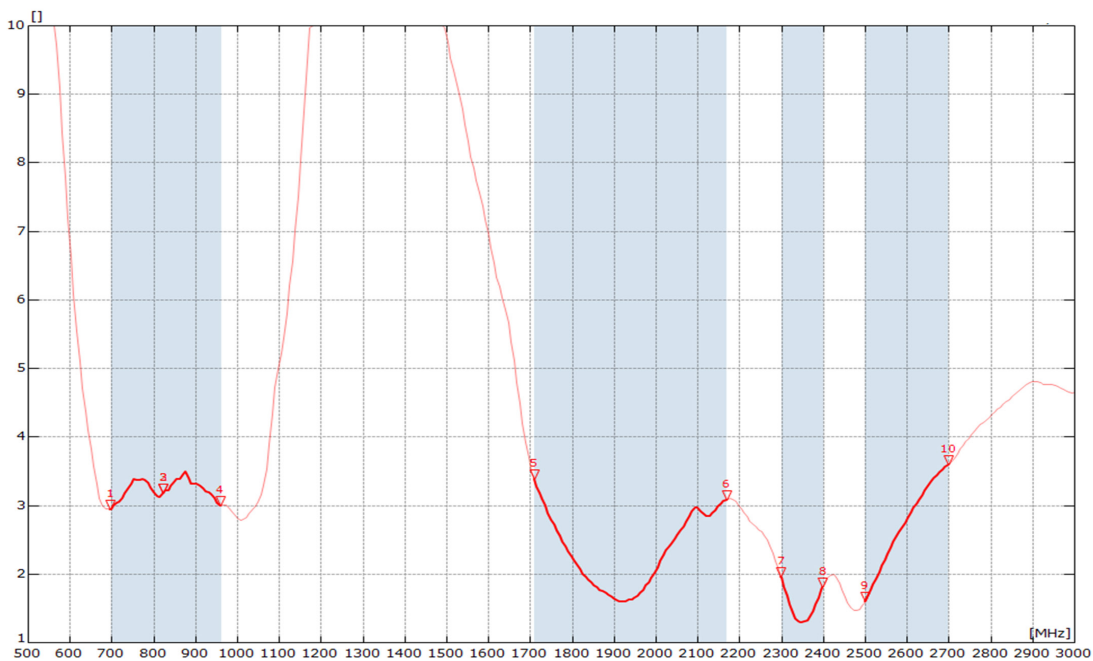

All data measured on Antenova's evaluation PCB Part
No. SR4L096-EVB-1

6.3. Efficiency

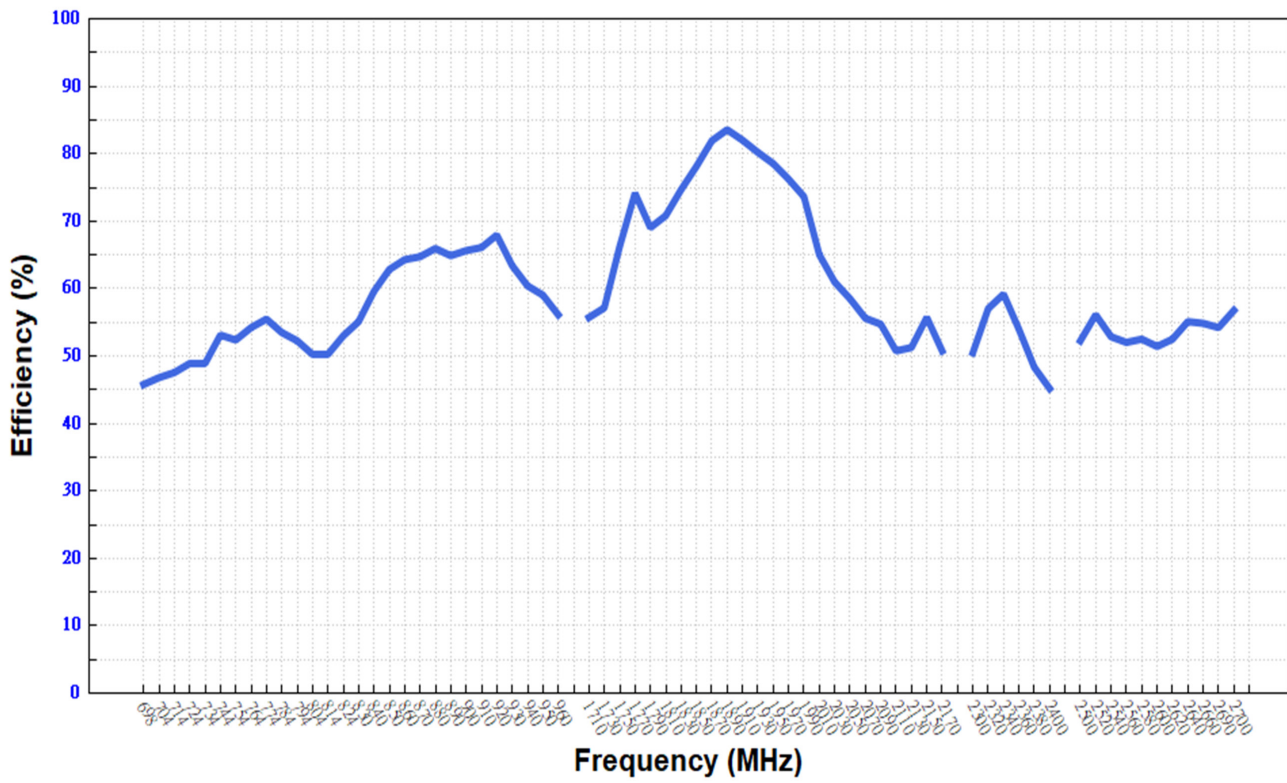

All data measured on Antenova's evaluation PCB Part
No. SR4L096-EVB-1

6.4. Antenna pattern

6.4.1. 764MHZ

3D pattern at 764MHz

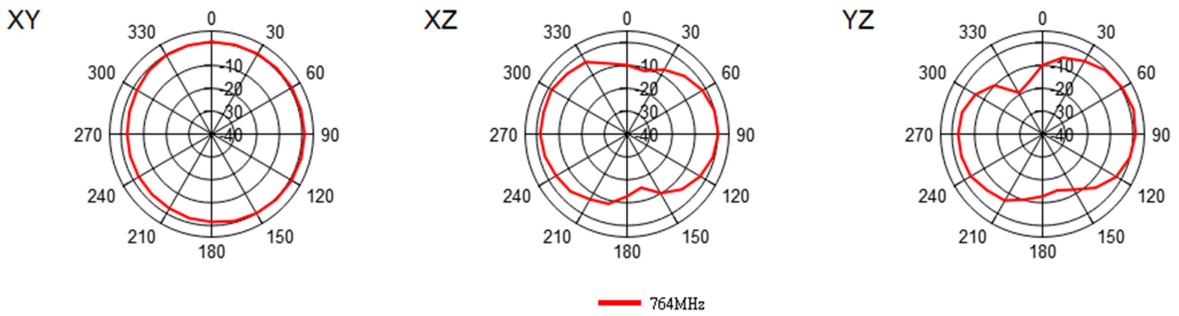
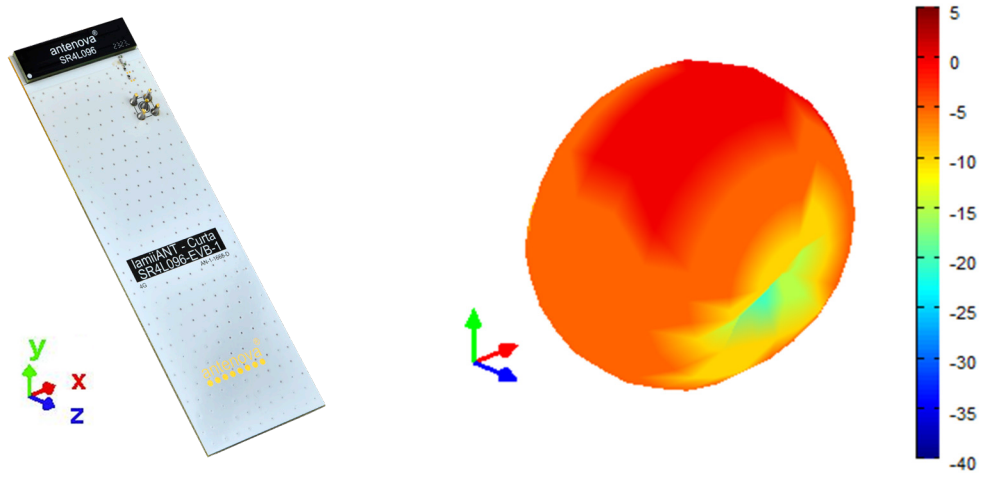

6.4.2. 900MHZ

3D pattern at 900MHz

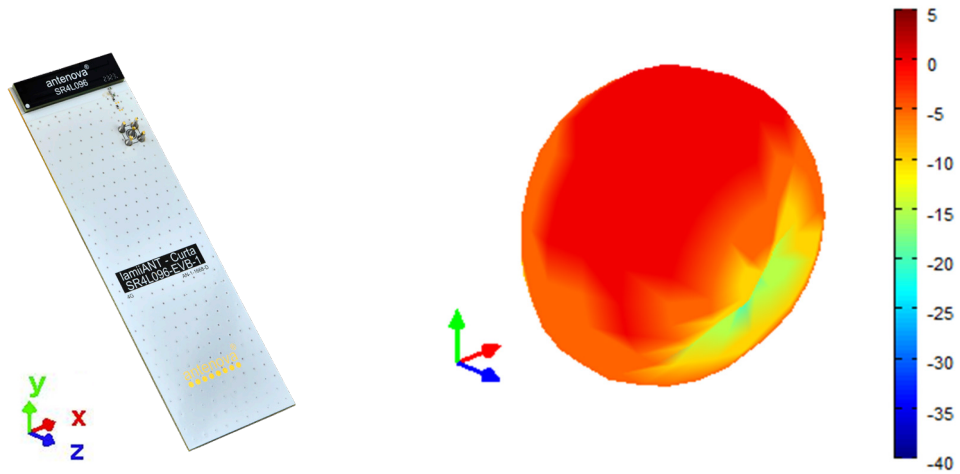

XY

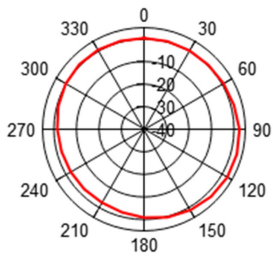

XZ

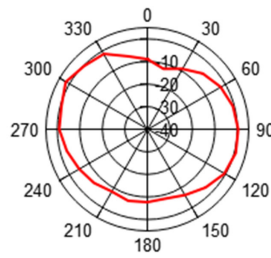

YZ

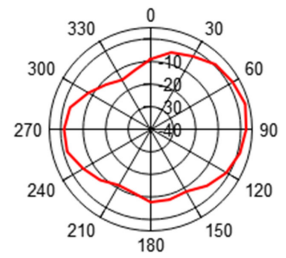

900MHz

6.4.3. 1930MHZ

3D pattern at 1930MHz

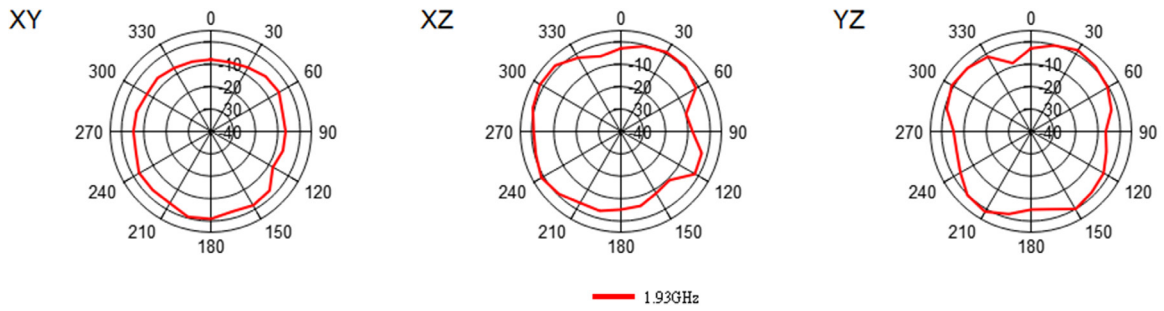
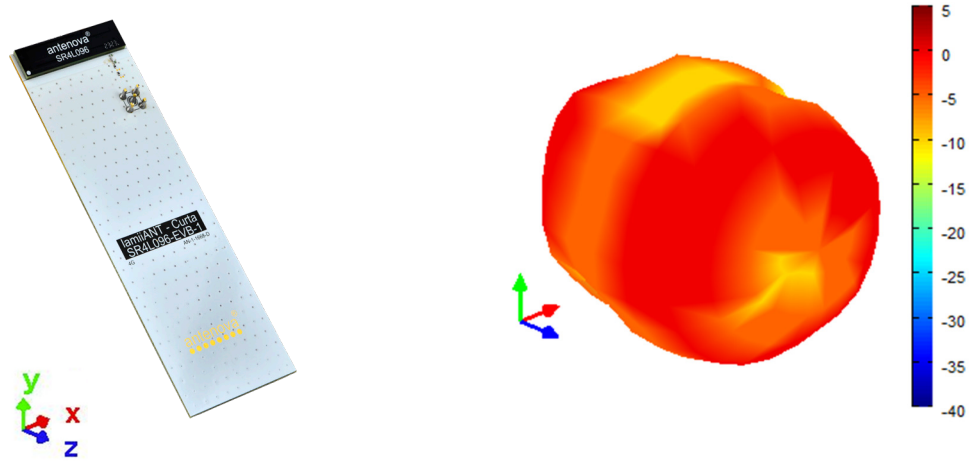

6.4.4. 2340MHZ

3D pattern at 2340MHz

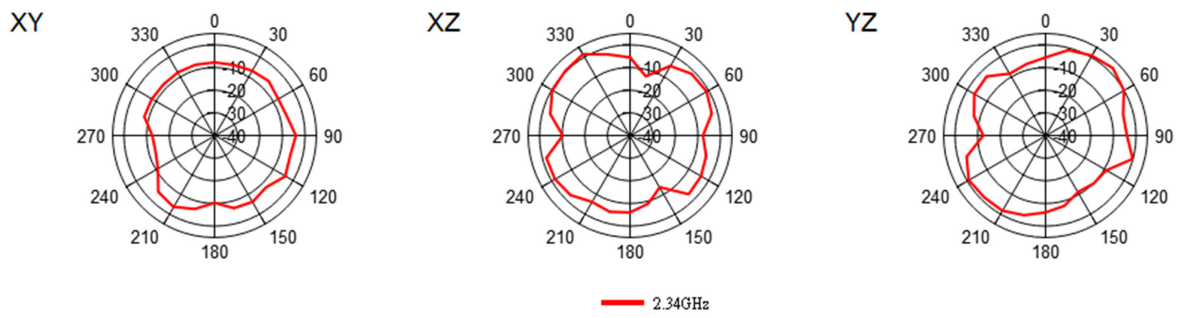
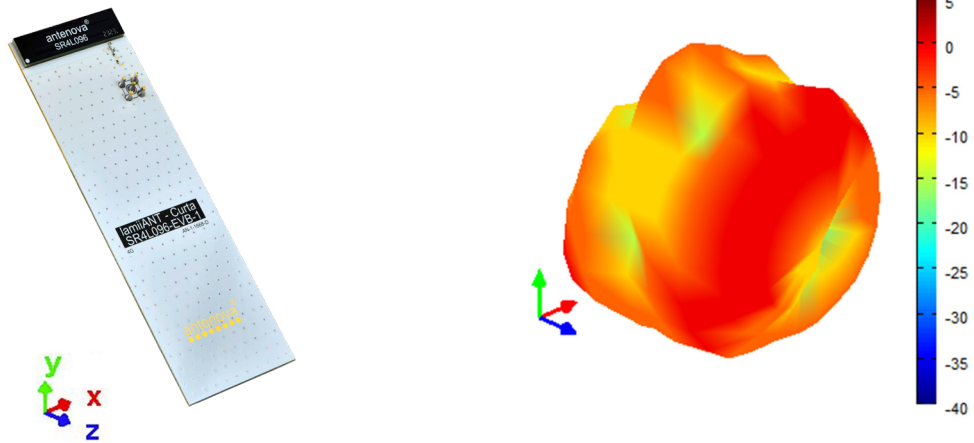

6.4.5. 2600MHZ

3D pattern at 2600MHz

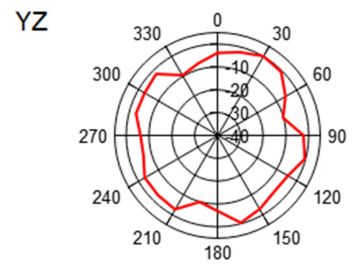
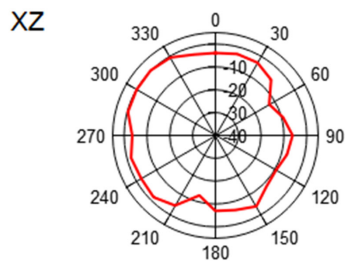
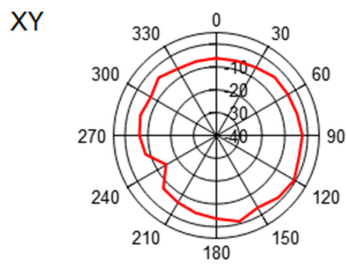
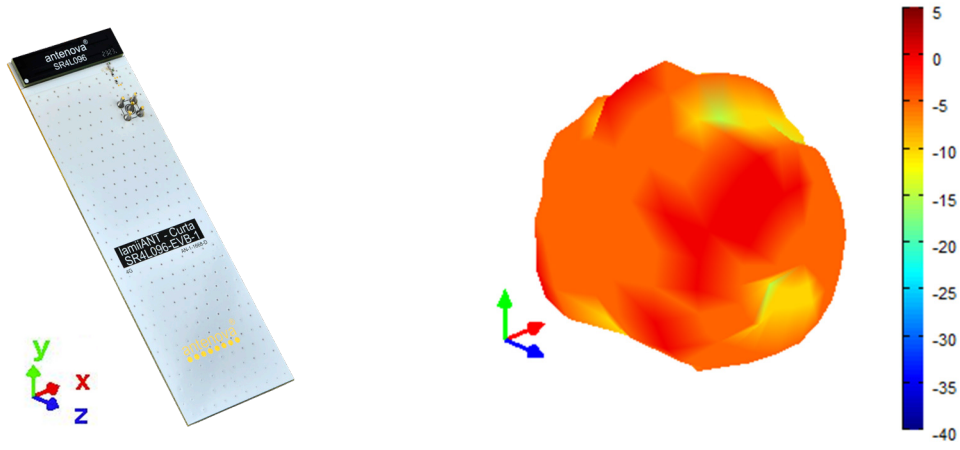

— 2.6GHz

7. Antenna dimensions

7.1. Dimensions Assembled

Top view

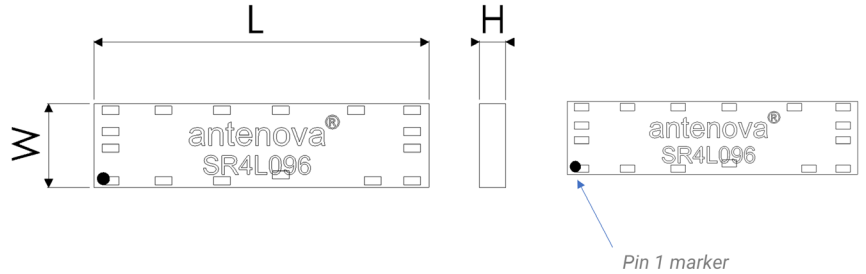

| L | W | H |
|-----------|-----------|----------|
| Length | Width | Height |
| 40.0 ±0.1 | 10.0 ±0.1 | 1.7 ±0.1 |

All dimensions in (mm)

Bottom view

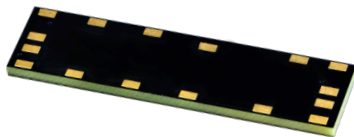

1-16copper pads: 1.0 x 2.0 (mm)

8. Schematic symbol and pin definition

The circuit symbol for the antenna is shown below. The antenna has 10 pins with only 2 as functional. All other pins are for mechanical strength.

| PIN | DESCRIPTION |
|--------|-------------------------------|
| 5 | Feed |
| Others | Not used (Mechanical only) |

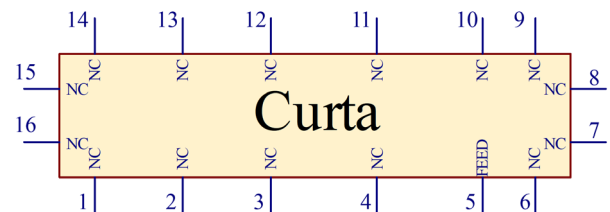

9. Host PCB footprint

The recommended host PCB footprint is below.

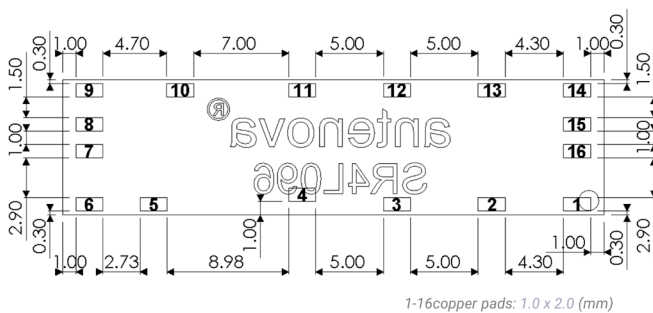

10. Electrical interface

10.1. Transmission line

All transmission lines should be designed to have a characteristic impedance of 50Ω.

- The length of each transmission line should be kept to a minimum
- All other parts of the RF system like transceivers, power amplifiers, etc, should also be designed to have a 50 Ω impedance

A co-planar transmission line can be designed using an online transmission line calculator tool, such as:

<https://blog.antenova.com/rf-transmission-line-calculator>

The PCB thickness, copper thickness and substrate dielectric constant are entered, then the tool calculates the transmission line width and gaps on either side of the track to give a 50 Ω impedance.

10.2. Matching circuit

The antenna requires a matching circuit that must be optimized for each product. The matching circuit will require up to seven components and the following circuit should be designed into the host PCB. Not all components may be required but should be included as a precaution. The matching network should be placed close to the antenna feed to ensure it is optionally effective in tuning the antenna.

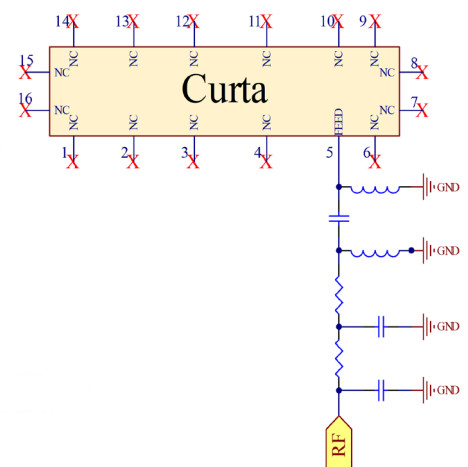

11. Antenna integration guide

We recommend the following during the design phase to maximise antenna performance and minimize noise:

- Minimum 4 layer PCB
- Route signals and power internally where possible
- Flood all layers with ground
- Knit ground on all layers together with plenty of vias

Follow placement guidance carefully, in addition Antenova provide technical support to help you through all stages of your design. Register for an account on <https://ask.antenova.com/> to access technical support.

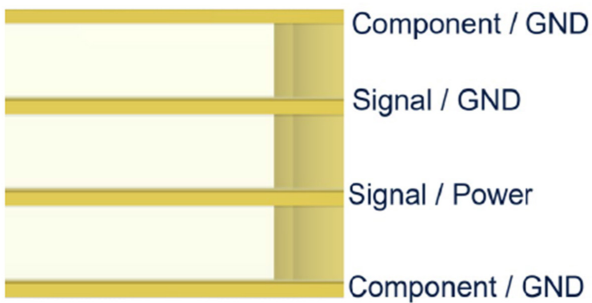

11.1. Antenna placement

The antenna requires clearance ideally in 5 spatial directions in antenna area as shown below.

The Antenova placement tool can be used to advise on antenna placement, see:

<https://blog.antenova.com/intelligent-antenna-selection-and-placement-tool-antenova>

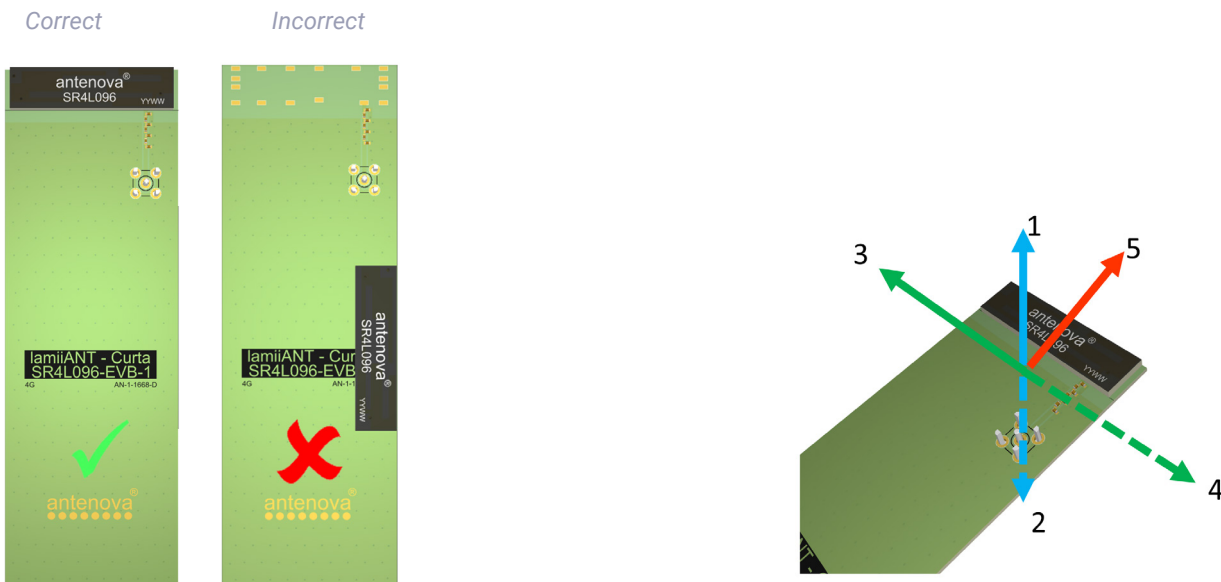

11.1. Antenna placement

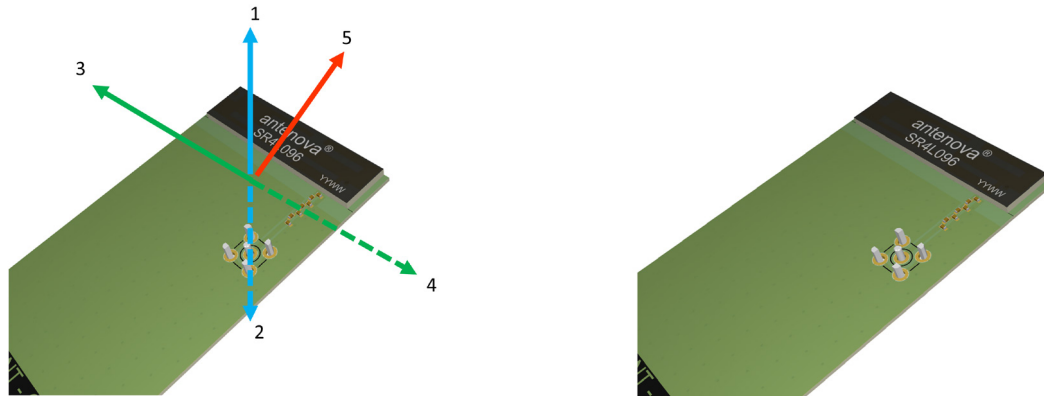

11.2. Host PCB layout

The host PCB must be designed using the PCB footprint shown with the correct clearances. An example of the PCB layout shows the antenna footprint. Please note this clearance area is critical to the performance of the antenna and must be applied through all layers of the PCB.

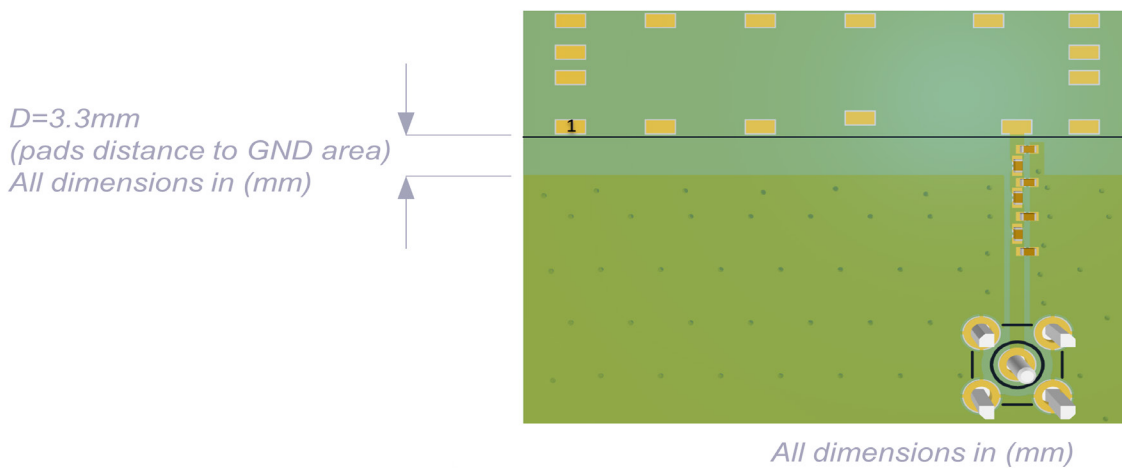

11.3. Host PCB clearance

The host PCB must be designed using the PCB footprint shown with the correct clearances. An example of the PCB layout shows the antenna footprint. Please note this clearance area is critical to the performance of the antenna and must be applied through all layers of the PCB.

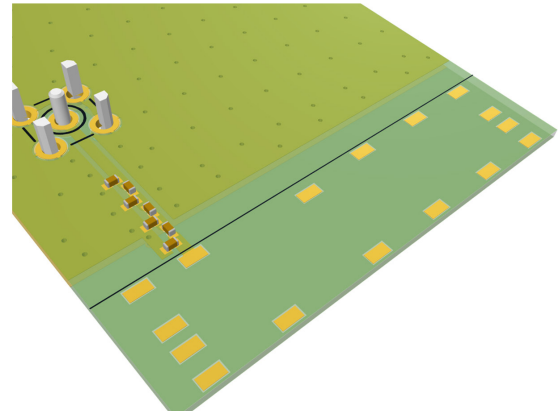
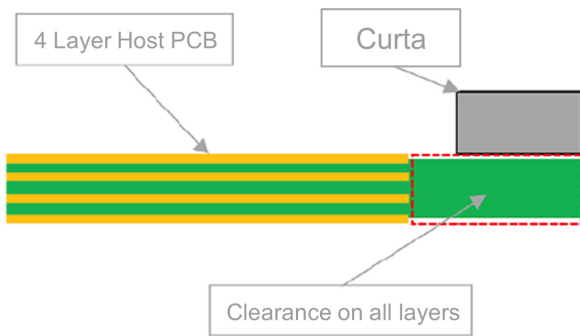

Below shows the antenna footprint and clearance through all layers on the PCB. Only the antenna pads and connections to feed and GND are present within this clearance area.

The best position for the antenna is in the full clearance area PCB. However, this antenna also can be placed at right side with at least 15mm gap from the top of PCB GND.

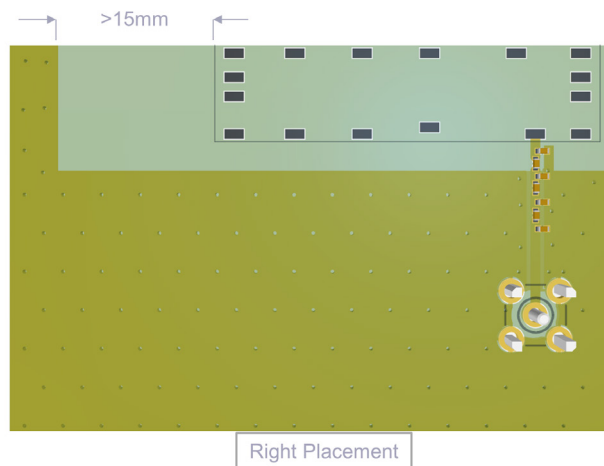

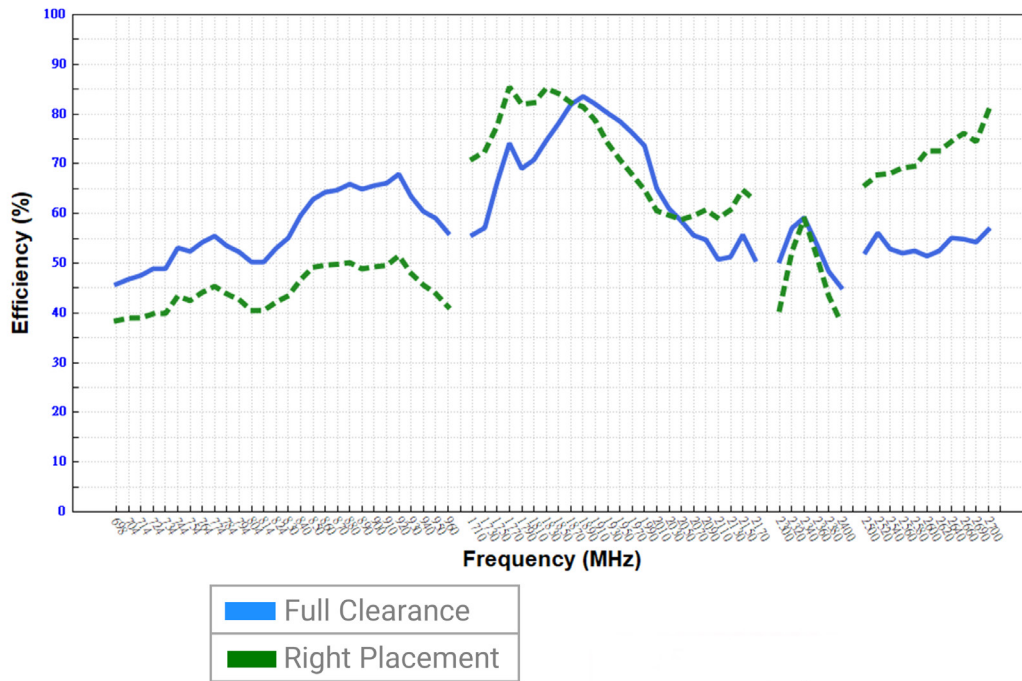

Antenna Engineer

12. Reference board

A reference board is used for evaluating the antenna R4L096 and it includes a SMA female connector. (part number SR4L096-EVB-1)

To order a reference board please see antenova.com



12.1. Reference board matching circuit

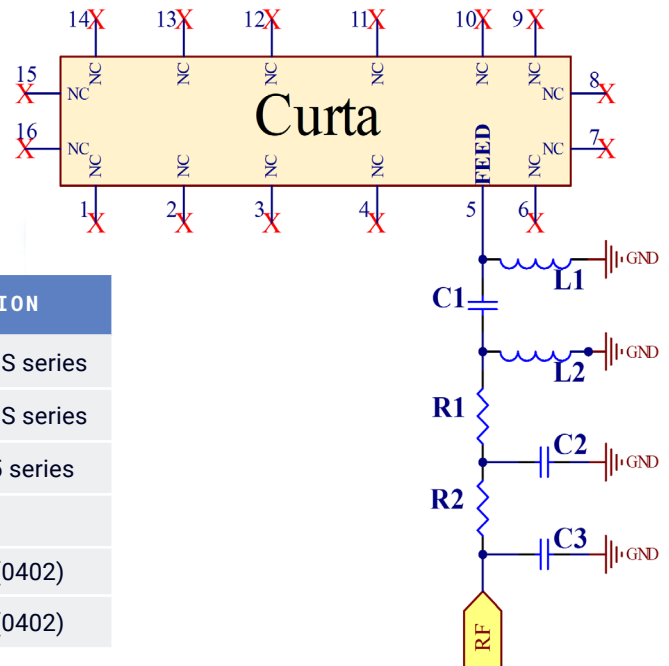

| DESIGNATOR | TYPE | VALUE | DESCRIPTION |
|------------|------------|-------|-----------------------|
| L1 | Inductor | 6.8nH | Murata LQG15HS series |
| L2 | Inductor | 12nH | Murata LQG15HS series |
| C1 | Capacitor | 3.0pF | Murata GJM15 series |
| C2, C3 | Not Fitted | | |
| R1 | Resistor | 0 ohm | Non-specific (0402) |
| R2 | Resistor | 0 ohm | Non-specific (0402) |

13. Soldering

This antenna is suitable for lead free soldering. The reflow profile should be adjusted to suit the device, oven and solder paste, while observing the following conditions:

- For leaded soldering, the maximum temperature should not exceed 240 °C.
- For lead free soldering, a maximum temperature of 255 °C for no more than 20 seconds is permitted.
- The antenna should not be exposed to temperatures exceeding 120 °C more than 3 times during the soldering process.

14. Hazardous material regulation conformance

The antenna has been tested to conform to RoHS and REACH requirements. A certificate of conformance is available from Antenova's website.

15. Packaging

15.1. Optimal storage conditions

| | |
|---------------|---|
| TEMPERATURE | -10°C to 40°C |
| HUMIDITY | Less than 75% RH |
| SHELF LIFE | 24 Months |
| STORAGE PLACE | Away from corrosive gas and direct sunlight |
| PACKAGING | Reels should be stored in unopened sealed manufacturer's plastic packaging. |
| MSL LEVEL | 1 |

Note: Storage of open reels of antennas is not recommended due to possible oxidization of pads on antennas. If short term storage is necessary, then it is highly recommended that the bag containing the antenna reel is re-sealed and stored in conditions as described in the tabel above.

The shelf life of the antenna is 2 years provided the factory seal on the package has not been broken.

15.2. Tape characteristics

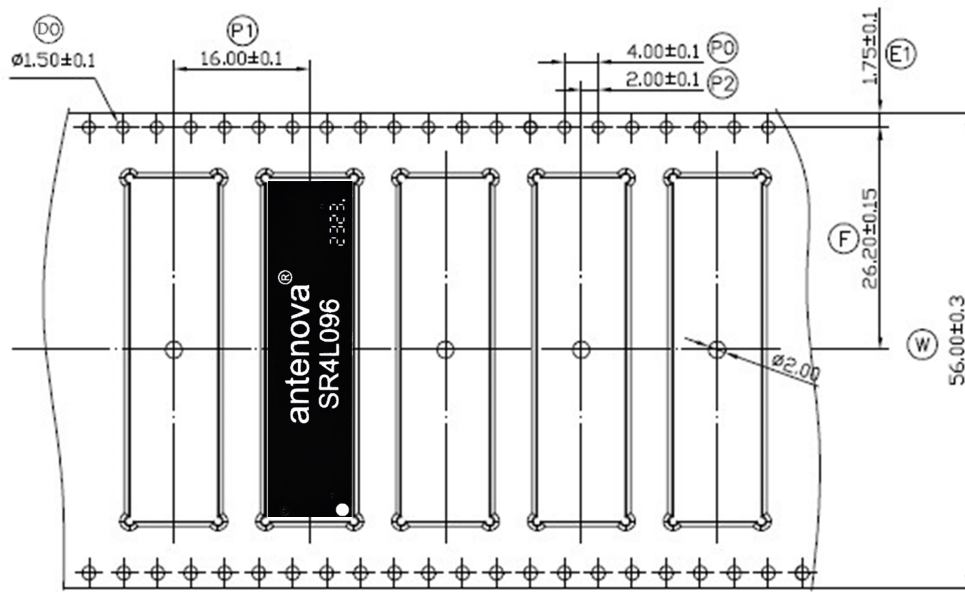

| P0 | P1 | P2 | D0 |
|------------|-------------|------------|------------|
| 4.00 ± 0.1 | 16.00 ± 0.1 | 2.00 ± 0.1 | 1.50 ± 0.1 |

| E | F | W |
|------------|--------------|-------------|
| 1.75 ± 0.1 | 26.20 ± 0.15 | 56.00 ± 0.3 |

All dimensions in (mm)

| QUANTITY | LEADING SPACE | TRAILING SPACE |
|-----------------|--------------------------|--------------------------|
| 1000 pcs / reel | 25 blank antenna holders | 25 blank antenna holders |

15.3. Reel dimensions

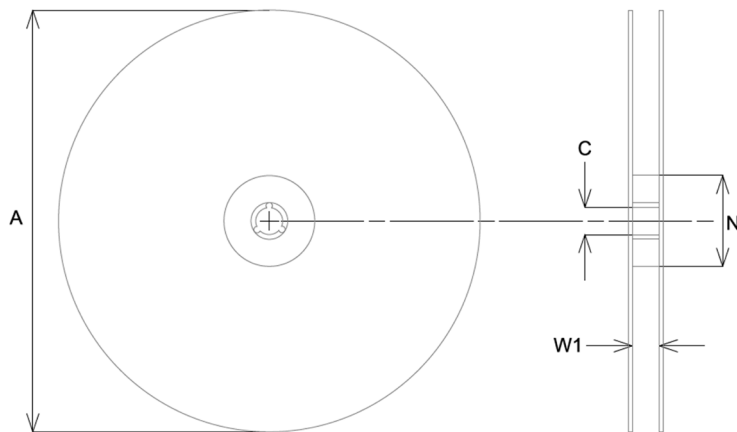

| A | C | N | W1 |
|-------------|------------|-------------|----------|
| 330.0 ± 2.0 | 13.0 ± 0.5 | 178.0 ± 0.5 | 56 ± 2.0 |

All dimensions in (mm)

15.4. Box dimensions

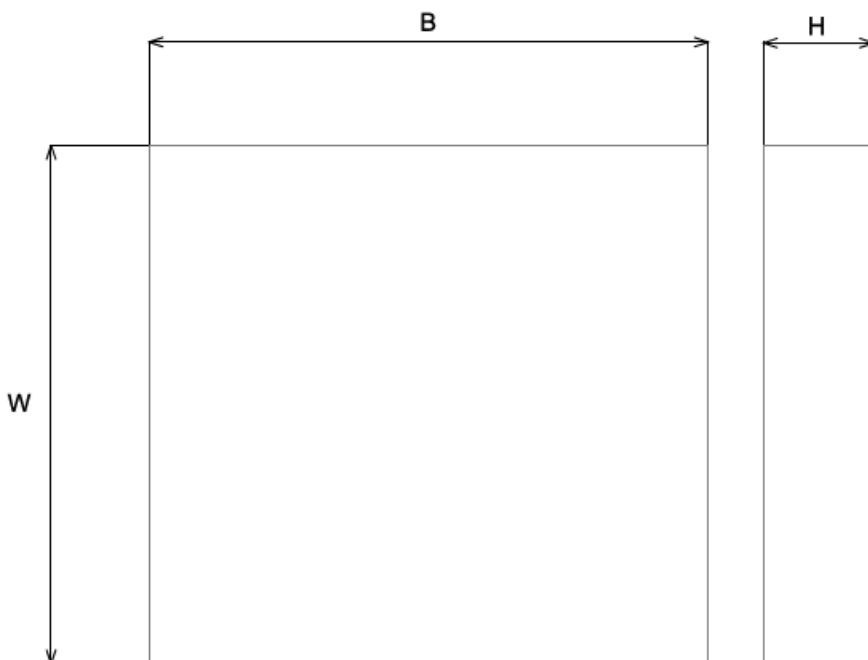

| WIDTH (W) | BREADTH (B) | HEIGHT (H) |
|-----------|-------------|------------|
| 350mm | 355mm | 70mm |

15.5. Bag properties

Reels are supplied in protective plastic packaging.

15.6. Reel label information



Quality statements

Antenova’s products conform to REACH and RoHS legislation. For our statements regarding these and other quality standards, please see antenova.com.



Antenova reserves all rights to the contents of this document. Antenova gives no warranties based solely on the accuracy or completeness of the contents of this document and reserves the right to make changes to the specifications of the products described herein at any time and without notice.

Datasheet version
 1.01 release JUL 1 2023

Antenna design, integration and test resources

Product designers – the details contained in this datasheet will help you to complete your embedded antenna design. Please follow our technical advice carefully to obtain optimum antenna performance.

We aim to support our customers to create high performance wireless products. You will find a wealth of design resources, calculators and case studies to aid your design on our website.

Antenova's design laboratories are equipped with the latest antenna design tools and test chambers. We provide antenna design, test and technical integration services to help you complete your design and obtain the required certifications.

If you cannot find the antenna you require in our product range, please contact us to discuss creating a custom antenna to meet your exact requirements.

Share knowledge with RF experts around the world.

ask.antenova is a global forum for designers and engineers working with wireless technology.

[VISIT ASK.ANTENOVA](https://www.ask.antenova.com)

Visit [antenova.com](https://www.antenova.com)

Order antenna samples and evaluation boards, and read our antenna resources

[VISIT ANTENOVA.COM](https://www.antenova.com)

Request a volume quotation for antennas:

sales@antenova.com

Global headquarters

Antenova Ltd, 2nd Floor Titan Court, 3 Bishop Square, Hatfield, AL10 9NA

+44 (0) 1707 927589

X-ON Electronics

Largest Supplier of Electrical and Electronic Components

Click to view similar products for [Antenna Development Tools](#) category:

Click to view products by [Antenova](#) manufacturer:

Other Similar products are found below :

[PCSD.06.A](#) [1002427-02](#) [1004796-01](#) [YC0010AAEVB](#) [1001013-02](#) [1005454-01](#) [1004795-01](#) [1002436-01](#) [ACR1004A-EVB](#) [RAC00024-EVB](#) [RAC00245-EVB](#) [ACR1004GC-EVB](#) [W3012-K](#) [W3006-K](#) [SPD.25A](#) [74889100TB](#) [A10192-U1](#) [DTAD.01.A.50](#) [SR4C033-EVB-1](#) [AEK-LTE-CER](#) [IOT-K](#) [SR4W035-EVB-1](#) [W3010-K](#) [LORA-K](#) [ISM-K](#) [REFLECTOR-EVB-1](#) [ACAG0201-2450-EVB](#) [ACAG0301-15752450-EVB](#) [ACAG0301-1575-EVB](#) [ACAG0301-24505500-EVB](#) [ACAG0301-5500-EVB](#) [ACAG0801-2450-EVB](#) [ACAG1204-433-EVB](#) [ACAG1204-868-EVB](#) [ACAG1204-915-EVB](#) [ACAR0301-SW2-EVB](#) [ACAR3005-C2WB-EVB](#) [ACAR3005-S824-EVB](#) [ACAR3705-S698-EVB](#) [ACAR4008-S698-EVB](#) [ACR0301U-EVB](#) [ACR1504I3-EVB-A](#) [ACR1504I3-EVB-S](#) [ACR2005I4-EVB](#) [ACR4006X-EVB](#) [PRO-EB-450](#) [PRO-EB-453](#) [PRO-EB-472](#) [PRO-EB-476](#) [PRO-EB-550](#)