

DATASHEET

Dolo

SR4W089 • LAMIANT[®]



Features

Designed for 2.4GHz applications:

- Bluetooth / BLE, Wi-Fi[®] (802.11a/b/g/n), ZigBee[®]
- High efficiency (75%)
- Small Clearance Area (7.6 x 6mm)
- Surface Mounted Component
- Supplied on tape and reel

Contents

1. Description	2
2. Applications	2
3. General data	2
4. Part number	3
5. RF characteristics	3
6. RF performance	4
6.1. Return loss	4
6.2. VSWR	4
6.3. Efficiency	5
6.4. Antenna pattern	6
6.4. Antenna pattern	7
7. Antenna dimensions	8
7. Antenna Footprint	8
8. Schematic	9
9. Host PCB footprint	9
10. Electrical interface	10
10.1. Transmission line	10
10.2. Matching circuit	10
11. Antenna integration guide	11
11.1. Antenna placement	11
11.2. Host PCB Clearance	12
12. Reference board	13
13. Soldering	14
14. Hazardous material regulation conformance	14
15. Packaging	14

1. Description

Dolo is intended for use with all 2.4 GHz applications. A clearance area is required around the antenna, and the ground plane is used to radiate efficiently. Ideal for wearables and other small products.

2. Applications

- Wireless Sensor networks
- Wearables such as Fitness trackers
- Medical devices
-

3. General data

Frequency	2400 - 2500MHz
Polarization	Linear
Operating Temperature	-40°C to 125°C
Environmental Condition Test	ISO16750-4 5.1.1.1/5.1.2.1/5.3.2
Impedance With Matching	50 Ω
Weight	<0.1g
Antenna Type	SMD
Dimensions	7.5 x 4.0 x 0.9 (mm)

4. Part number

DOLO
SR4W089

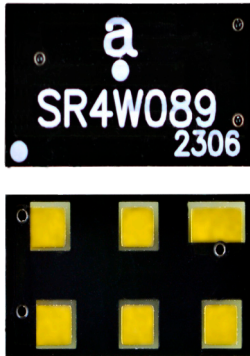

5. RF characteristics

Frequency	2400 – 2500 MHz
Peak Gain	3.0dBi
Average Gain	-1.2dB
Average Efficiency	76%
Maximum Return Loss	-10.6dB
Maximum VSWR	1.8:1

All data measured at antenna center position on Antenova's evaluation PCB Part No. SR4W089-EVB-1

6. RF performance

6.1. Return loss

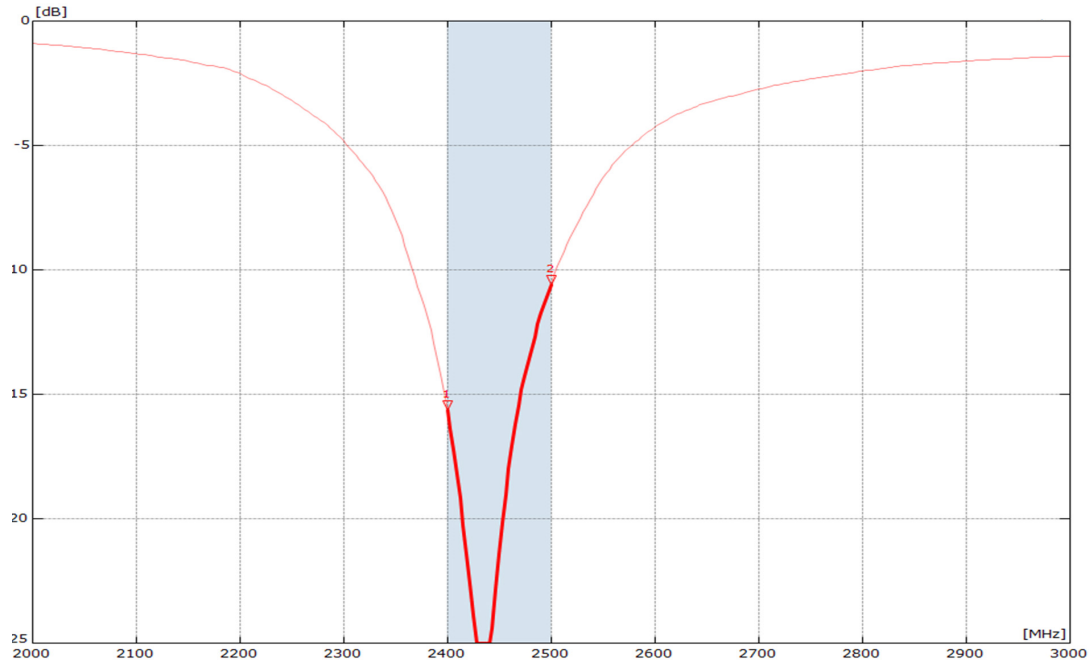

6.2. VSWR

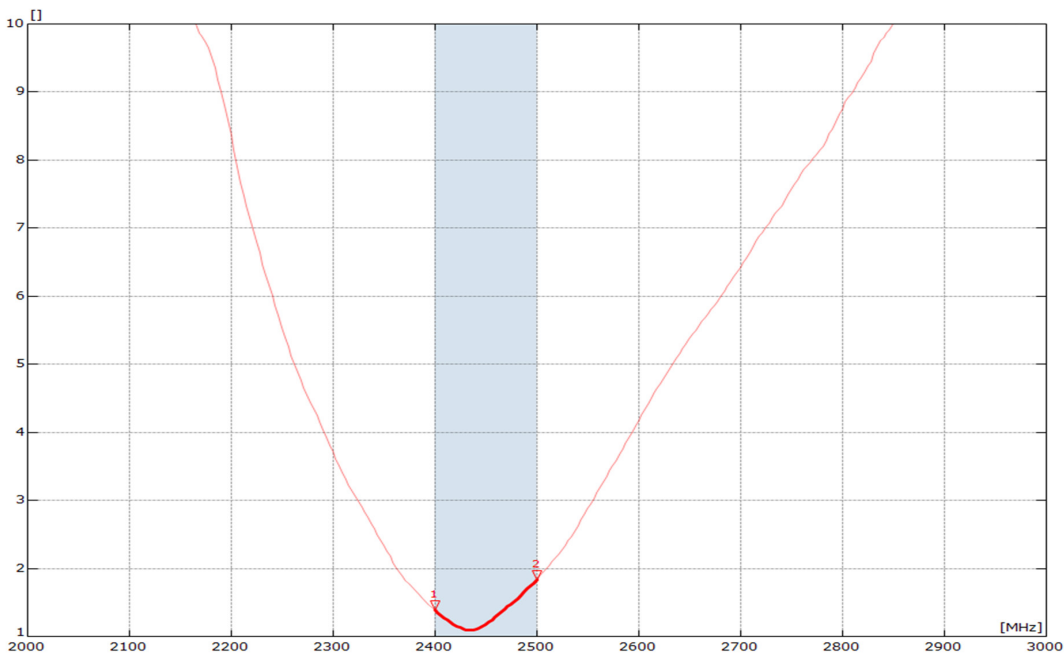

All data measured at antenna center position on Antenova's evaluation PCB Part No. SR4W089-EVB-1

6.3. Efficiency

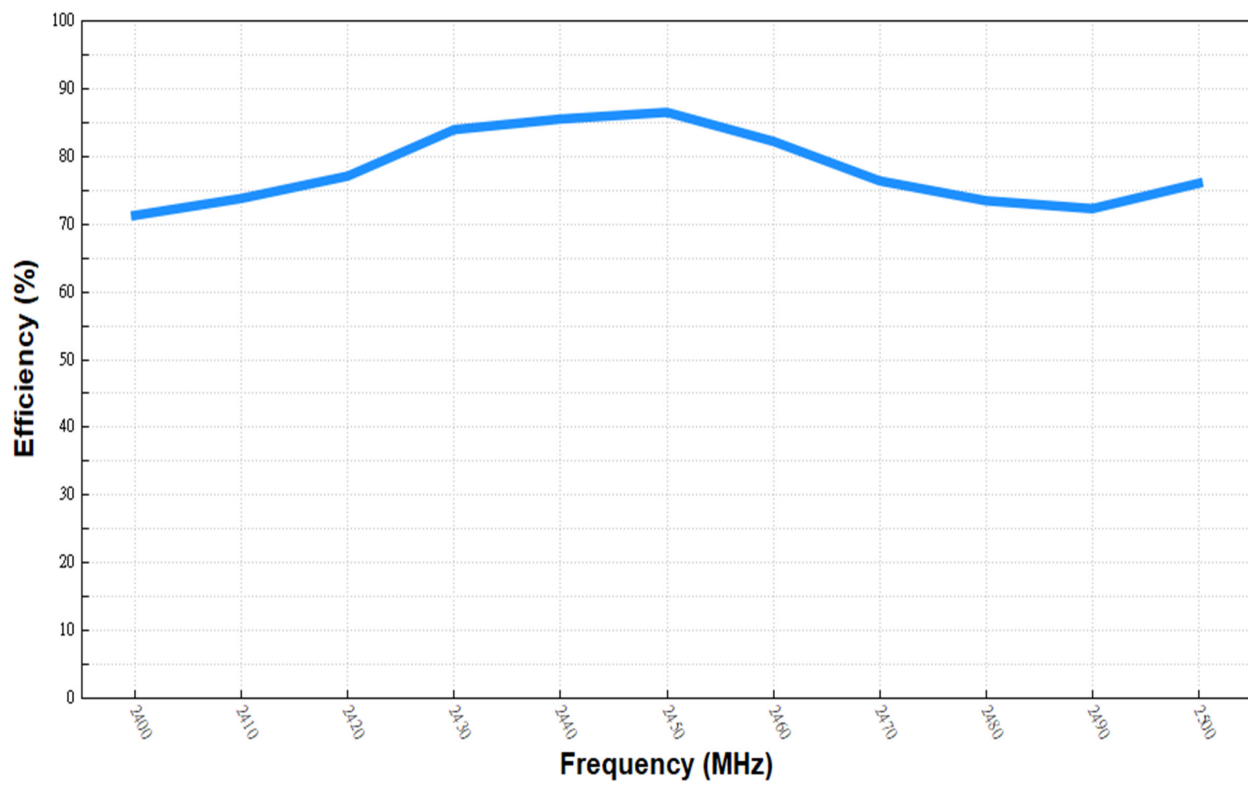

All data measured at antenna center position on Antenova's evaluation PCB Part No. SR4W089-EVB-1

6.4. Antenna pattern

6.4.1. 2400MHz – 2500MHZ

3D pattern at 2450MHz

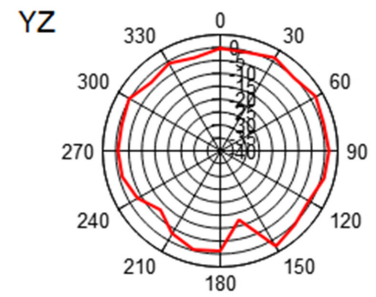
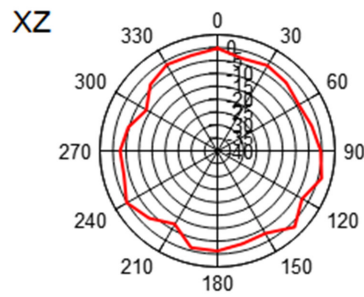
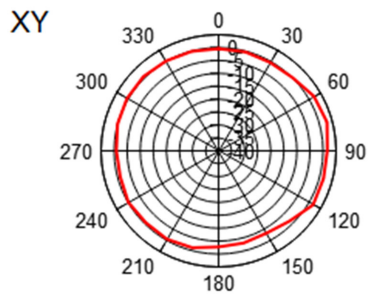
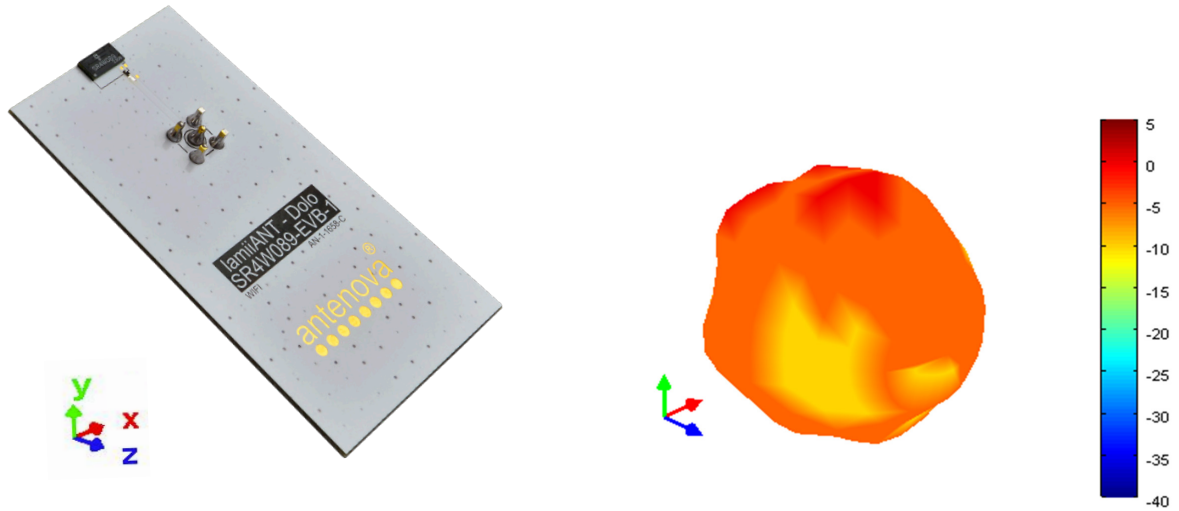

— 2.45GHz

7. Antenna dimensions

7.1. Dimensions Assembled

Top view

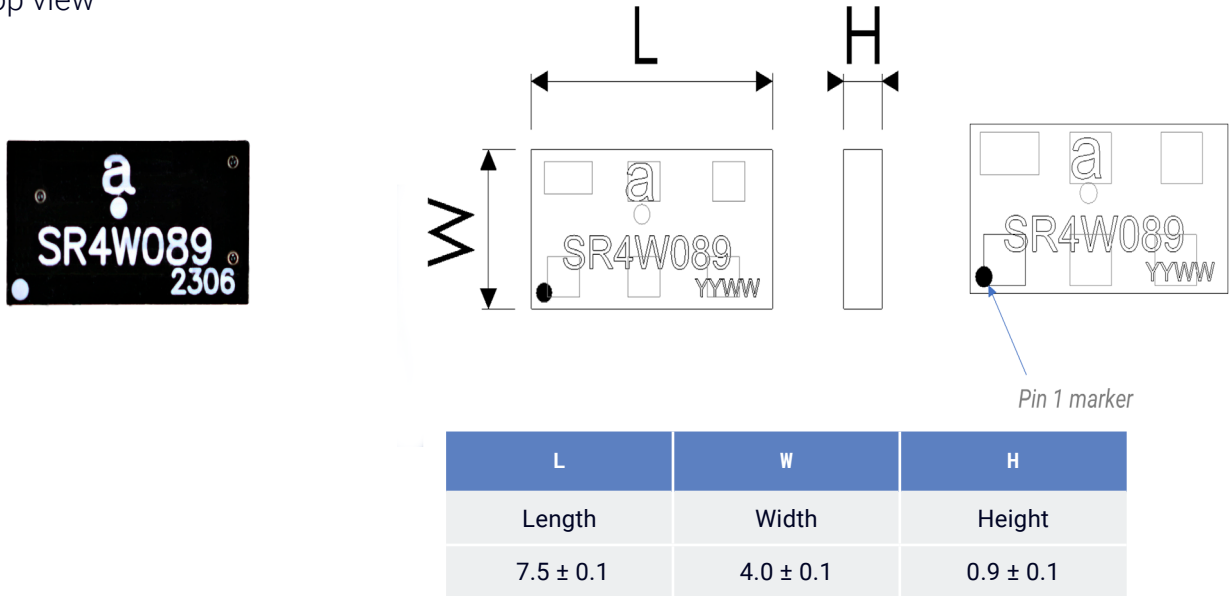

All dimensions in (mm)

7.2. Antenna Footprint

Bottom view

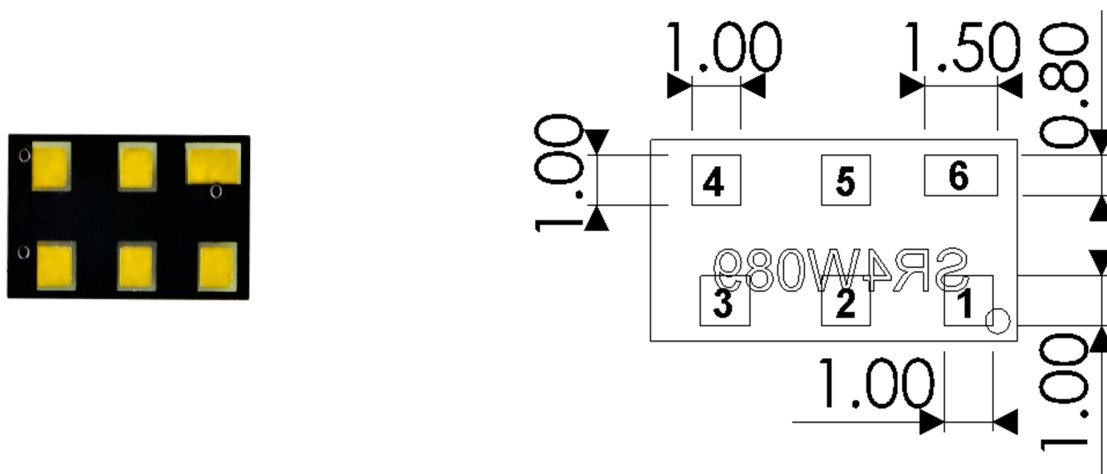

1-5 copper pads: 1.0 x 1.0 (mm)

6 copper pad: 1.5 x 0.8 (mm)

8. Schematic symbol and pin definition

The circuit symbol for the antenna is shown below. The antenna has 6 pins With 3 as functional. All other pins are for mechanical strength.

PIN	DESCRIPTION
3	Feed
4, 6	GND
1, 2, 5	Not used (Mechanical only)

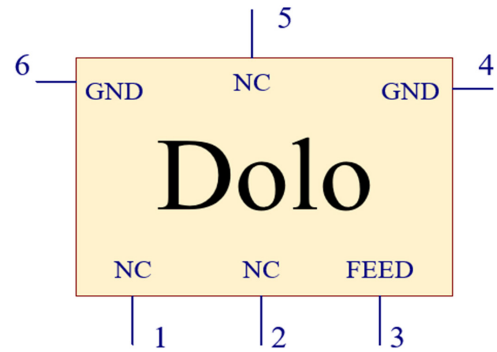

9. Host PCB footprint

The recommended host PCB footprint is below.

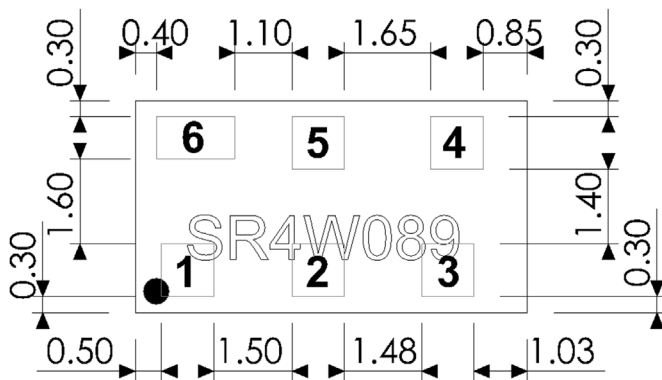

1-5 copper pads: 1.0 x 1.0 (mm)

6 copper pad: 1.5 x 0.8 (mm)

10. Electrical interface

10.1. Transmission line

All transmission lines should be designed to have a characteristic impedance of 50Ω.

- The length of each transmission lines should be kept to a minimum
- All other parts of the RF system like transceivers, power amplifiers, etc, should also be designed to have a 50 Ω impedance

A co-planar transmission line can be designed using an online transmission line calculator tool, such as:

<https://blog.antenova.com/rf-transmission-line-calculator>

The PCB thickness, copper thickness and substrate dielectric constant are entered, then the tool calculates the transmission line width and gaps on either side of the track to give a 50 Ω impedance.

10.2. Matching circuit

The antenna requires a matching circuit that must be optimized for each product. The matching circuit will require up to three components and the following circuit should be designed into the host PCB. Not all components may be required but should be included as a precaution. The matching network should be placed close to the antenna feed to ensure it is optionally effective in tuning the antenna.

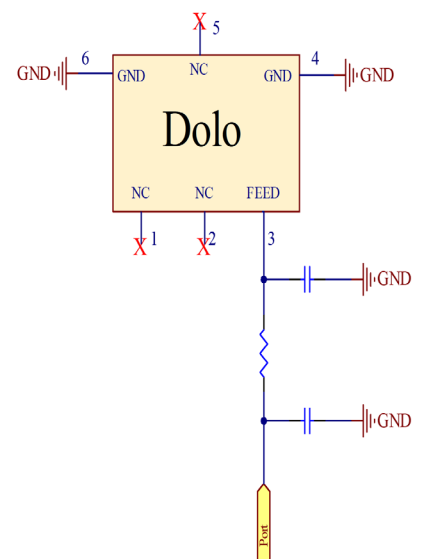

11. Antenna integration guide

We recommend the following during the design phase to maximise antenna performance and minimize noise:

- Minimum 4 layer PCB
- Route signals and power internally where possible
- Flood all layers with ground
- Knit ground on all layers together with plenty of vias

Follow placement guidance carefully. Antenova provide technical support to help you with your design, and also provide design assistance on PTCRB certification. Register for an account on <https://ask.antenova.com/> to access technical support.

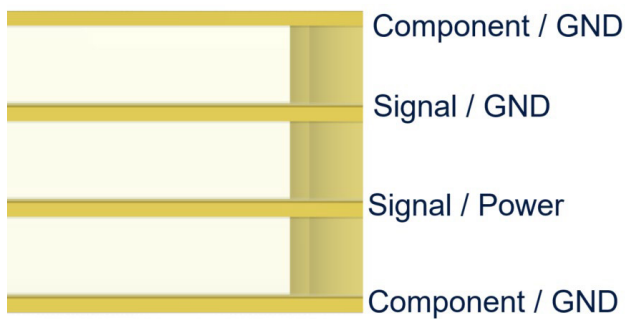

11.1. Antenna placement

11.1.1 Centre Placement

The best position for the antenna is in the centre of the PCB. The antenna requires clearance ideally in 5 spatial directions in antenna area as shown below.

The Antenova placement tool can be used to advise on antenna placement, see : <https://blog.antenova.com/intelligent-antenna-selection-and-placement-tool-antenova>

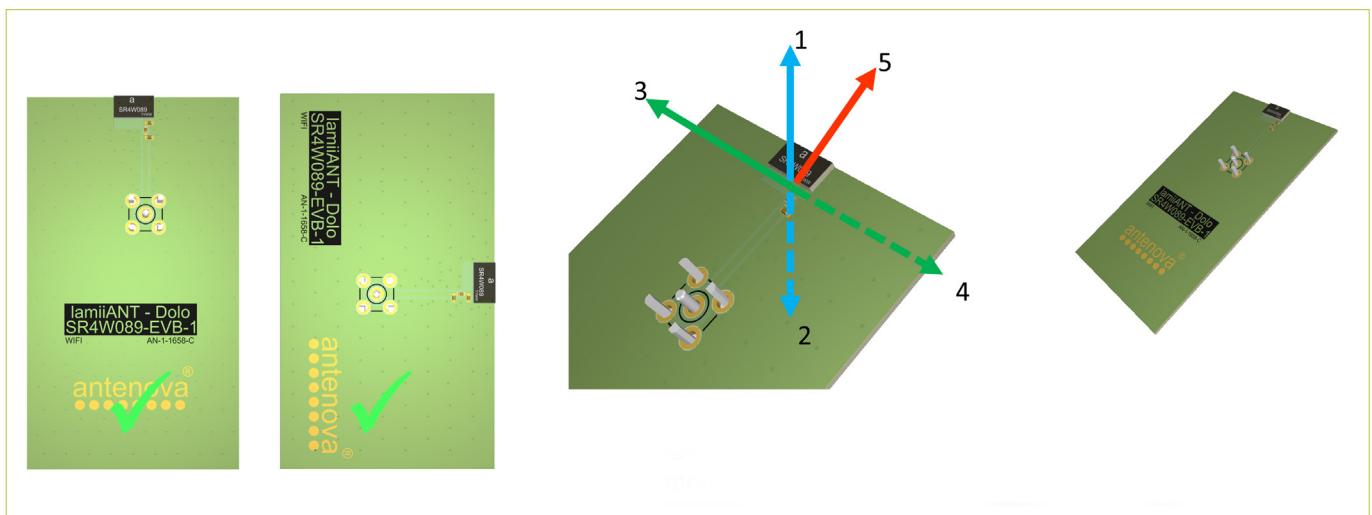

11.1.2. Off-Centre Placement

The best position for the antenna is in the centre of the PCB. However, this antenna also can be placed at left and right hand side with at least 6mm from the PCB edge.

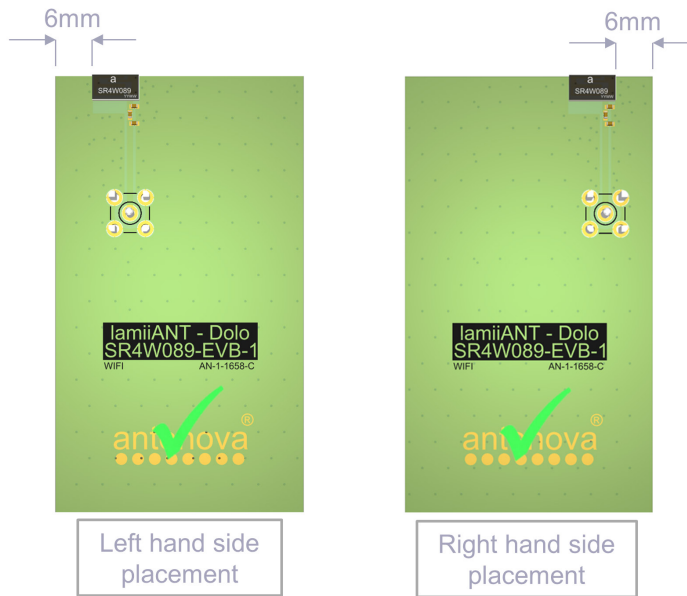

The graph displays the efficiency as a percentage, as can be seen, the efficiency is lower for antenna placement on the right-hand side. Therefore, for optimum performance the antenna should be placed in the centre or left-hand side.

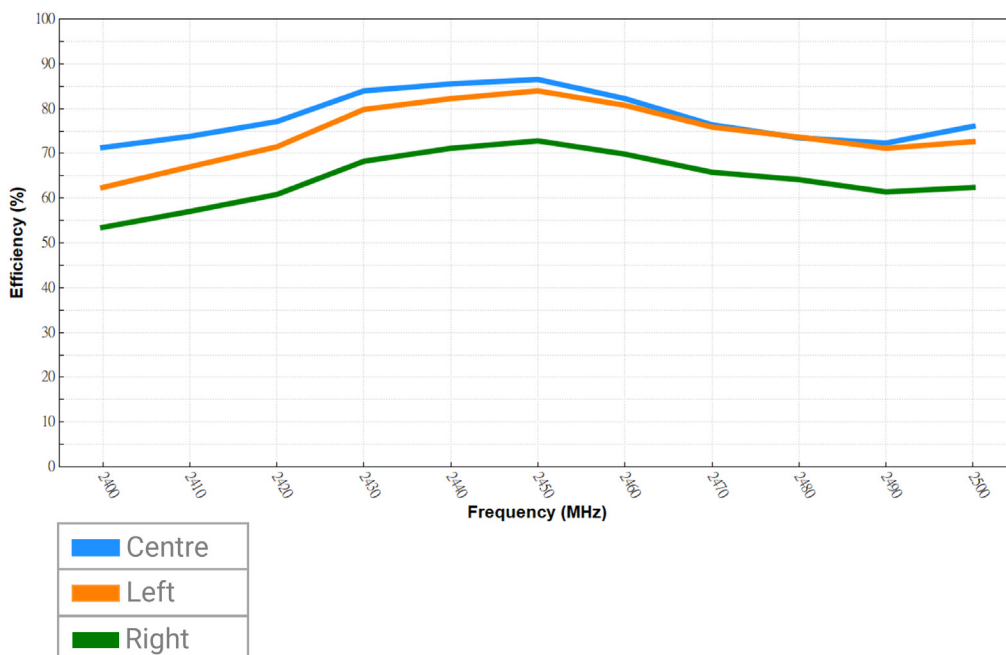

11.2. Host PCB Layout

11.2.1. PCB footprint

The host PCB must be designed using the PCB footprint shown with the correct clearances. An example of the PCB layout shows the antenna footprint. Please note this clearance area is critical to the performance of the antenna and must be applied through all layers of the PCB.

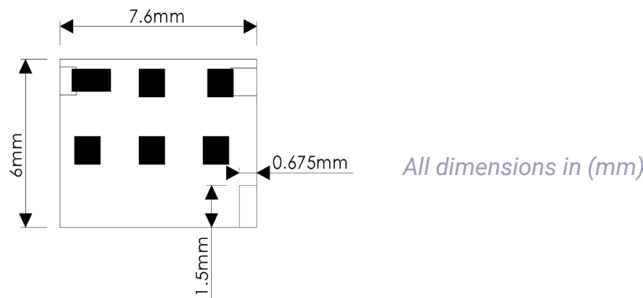

11.2.2. Host PCB Layout

3 examples of the PCB layout shows the different antenna placement footprint. Please note this clearance area is critical to the performance of the antenna and must be applied through all layers of the PCB.



11.3. Host PCB Clearance

The diagram below shows the antenna footprint and clearance through all layers on the PCB. Only the antenna pads and connections to feed and GND are present within this clearance area. Placement of components and GND with traces adjacent to the antenna should maintain a minimum clearance of 6mm x 7.6mm. The antenna should therefore be placed in as described in section 11.1 Antenna Placement.

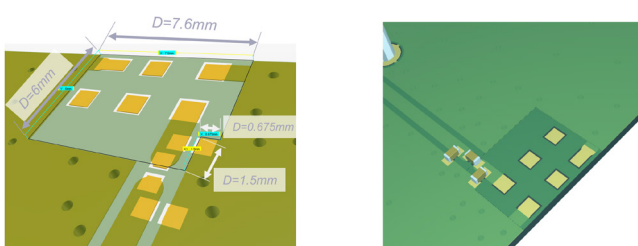

12. Reference board

A reference board is used for evaluating the antenna SRCIO24 and it includes a SMA female connector. (part number SR4W089-EVB-1)

To order a reference board please see antenna.com

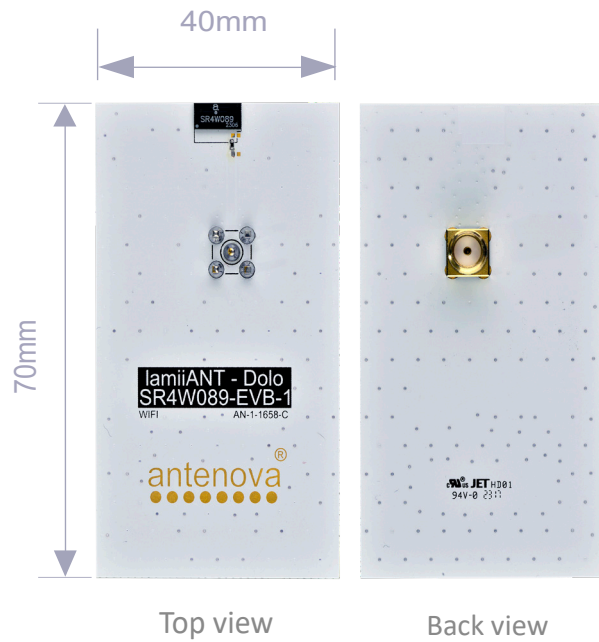

12.1. Reference board matching circuit

DESIGNATOR	TYPE	VALUE	Description
C1, C2	Not Fitted		
R1	Resistor	0 ohm	Non-specific (0402)

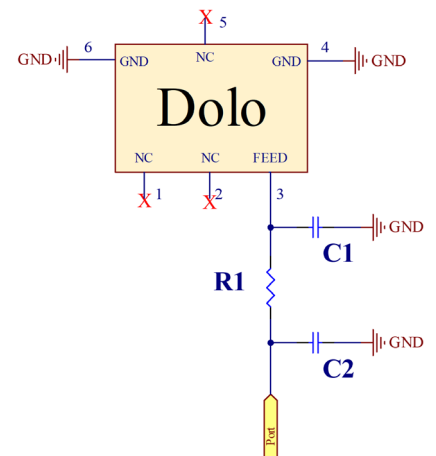

13. Soldering

This antenna is suitable for lead free soldering. The reflow profile should be adjusted to suit the device, oven and solder paste, while observing the following conditions:

- For leaded soldering, the maximum temperature should not exceed 240 °C.
- For lead free soldering, a maximum temperature of 255 °C for no more than 20 seconds is permitted.
- The antenna should not be exposed to temperatures exceeding 120 °C more than 3 times during the soldering process.

14. Hazardous material regulation conformance

The antenna has been tested to conform to RoHS and REACH requirements. A certificate of conformance is available from Antenova's website.

15. Packaging

15.1. Optimal storage conditions

TEMPERATURE	-10°C to 40°C
HUMIDITY	Less than 75% RH
SHELF LIFE	24 Months
STORAGE PLACE	Away from corrosive gas and direct sunlight
PACKAGING	Reels should be stored in unopened sealed manufacturer's plastic packaging.
MSL LEVEL	1

Note: Storage of open reels of antennas is not recommended due to possible oxidization of pads on antennas. If short term storage is necessary, then it is highly recommended that the bag containing the antenna reel is re-sealed and stored in conditions as described in the table above.

The shelf life of the antenna is 2 years provided the factory seal on the package has not been broken.

15.2. Tape characteristics

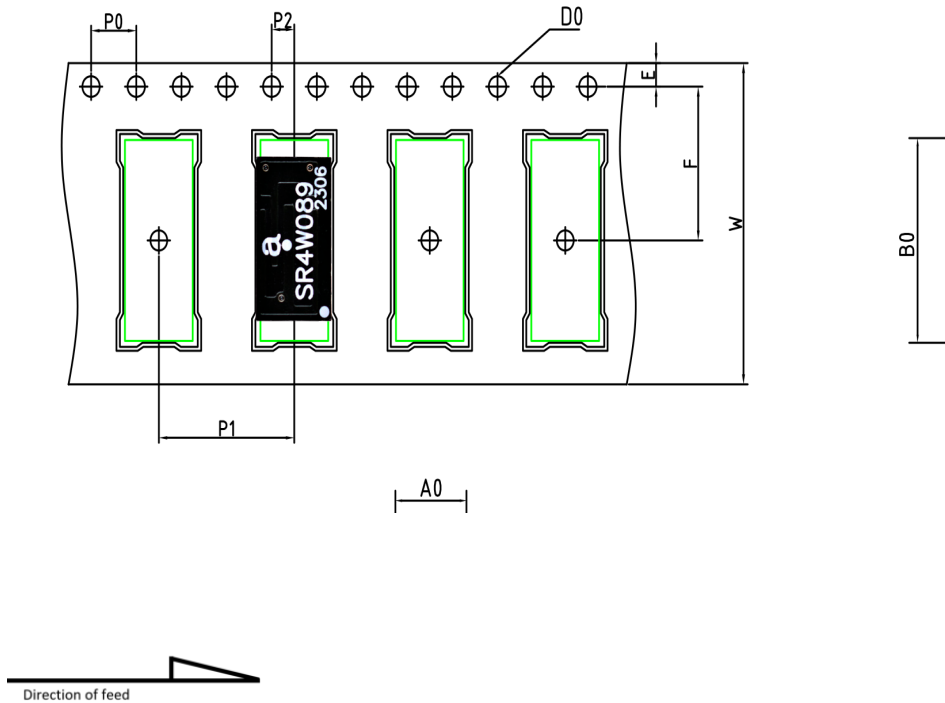

P0	P1	P2	D0
4.00 ± 0.1	8.00 ± 0.1	2.00 ± 0.1	1.55 ± 0.1

E	F	W
1.75 ± 0.1	7.50 ± 0.1	16.00 ± 0.3

All dimensions in (mm)

QUANTITY	LEADING SPACE	TRAILING SPACE
1000 pcs / reel	25 blank antenna holders	25 blank antenna holders

15.3. Reel dimensions

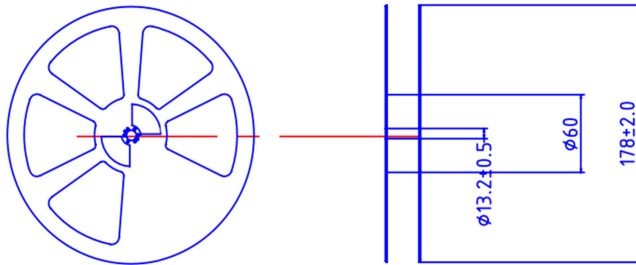

Reel Dimension	Type	Color	Size	Hub
	PS	WHITE	Ø178	Ø60

All dimensions in (mm)

15.4. Box dimensions

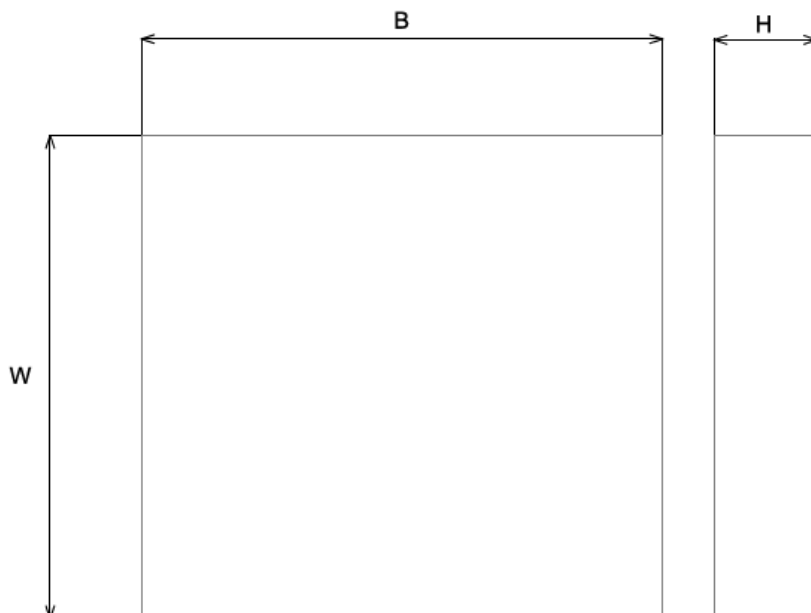

WIDTH (W)	BREADTH (B)	HEIGHT (H)
200mm	185mm	38mm

15.5. Bag properties

Reels are supplied in protective plastic packaging.

15.6. Reel label information



Quality statements

Antenova’s products conform to REACH and RoHS legislation. For our statements regarding these and other quality standards, please see antenova.com.



Antenova reserves all rights to the contents of this document. Antenova gives no warranties based solely on the accuracy or completeness of the contents of this document and reserves the right to make changes to the specifications of the products described herein at any time and without notice.

Datasheet version

1.01 release MAY 20 2023

Antenna design, integration and test resources

Product designers – the details contained in this datasheet will help you to complete your embedded antenna design. Please follow our technical advice carefully to obtain optimum antenna performance.

We aim to support our customers to create high performance wireless products. You will find a wealth of design resources, calculators and case studies to aid your design on our website.

Antenova's design laboratories are equipped with the latest antenna design tools and test chambers. We provide antenna design, test and technical integration services to help you complete your design and obtain the required certifications.

If you cannot find the antenna you require in our product range, please contact us to discuss creating a custom antenna to meet your exact requirements.

Share knowledge with RF experts around the world.

ask.antenova is a global forum for designers and engineers working with wireless technology.

[VISIT ASK.ANTENOVA](https://www.ask.antenova.com)

Visit [antenova.com](https://www.antenova.com)

Order antenna samples and evaluation boards, and read our antenna resources

[VISIT ANTENOVA.COM](https://www.antenova.com)

Request a volume quotation for antennas:

sales@antenova.com

Global headquarters

Antenova Ltd, 2nd Floor Titan Court, 3 Bishop Square, Hatfield, AL10 9NA

+44 (0) 1707 927589

X-ON Electronics

Largest Supplier of Electrical and Electronic Components

Click to view similar products for [Antenna Development Tools](#) category:

Click to view products by [Antenova](#) manufacturer:

Other Similar products are found below :

[PCSD.06.A](#) [1002427-02](#) [1004796-01](#) [YC0010AAEVB](#) [1001013-02](#) [1005454-01](#) [1004795-01](#) [1002436-01](#) [ACR1004A-EVB](#) [RAC00024-EVB](#) [RAC00245-EVB](#) [ACR1004GC-EVB](#) [W3012-K](#) [W3006-K](#) [SPD.25A](#) [74889100TB](#) [A10192-U1](#) [DTAD.01.A.50](#) [SR4C033-EVB-1](#) [AEK-LTE-CER](#) [IOT-K](#) [SR4W035-EVB-1](#) [W3010-K](#) [LORA-K](#) [ISM-K](#) [REFLECTOR-EVB-1](#) [ACAG0201-2450-EVB](#) [ACAG0301-15752450-EVB](#) [ACAG0301-1575-EVB](#) [ACAG0301-24505500-EVB](#) [ACAG0301-5500-EVB](#) [ACAG0801-2450-EVB](#) [ACAG1204-433-EVB](#) [ACAG1204-868-EVB](#) [ACAG1204-915-EVB](#) [ACAR0301-SW2-EVB](#) [ACAR3005-C2WB-EVB](#) [ACAR3005-S824-EVB](#) [ACAR3705-S698-EVB](#) [ACAR4008-S698-EVB](#) [ACR0301U-EVB](#) [ACR1504I3-EVB-A](#) [ACR1504I3-EVB-S](#) [ACR2005I4-EVB](#) [ACR4006X-EVB](#) [PRO-EB-450](#) [PRO-EB-453](#) [PRO-EB-472](#) [PRO-EB-476](#) [PRO-EB-550](#)