

Admotus

SRCG091 • ceriANT[®]



Features

- Ceramic Antenna for L1 GNSS signals on all constellations
- GPS (L1), GLONASS (L1), Galileo (E1), BeiDou (B1), QZSS
Antenna clearance area 15x7mm
- High efficiency of 53% across the L1 band
- Complies to Reach & RoHS standards

Contents

1.	Description	2
2.	Applications	2
3.	General data	2
4.	Part number	3
5.	RF characteristics	3
6.	RF performance	4
6.1.	Return loss	4
6.2.	VSWR	4
6.3.	Efficiency	5
6.4.	Antenna patterns	6
7.	Antenna dimensions	7
7.1.	Antenna dimensions	7
7.2.	Antenna footprint	7
8.	Schematic	8
9.	Host PCB footprint	8
10.	Electrical interface	9
10.1.	Transmission line	9
10.2.	Matching circuit	9
11.	Antenna integration guide	10
11.1.	Antenna placement	10
11.2.	Host PCB Clearance	11
12.	Reference board	12
12.1.	Reference board matching circuit	12
12.2.	Reduced size ground plane	13
12.3.	Host PCB size	14
13.	Soldering	15
14.	Hazardous material regulation conformance	15
15.	Packaging	15
15.1.	Optimal storage conditions	15
15.2.	Tape	16
15.3.	Reel dimensions	16
15.4.	Box dimensions	17
15.5.	Bag properties	17
15.6.	Information	17

1. Description

The Admotus ceramic antenna is suitable for all GNSS positioning applications in the L1 band (1559 – 1609 MHz). The antenna is ultra-low profile with an omni-directional pattern and performs well on small PCB sizes. It gives comparable performance to a small patch antenna on a small ground plane.

2. Applications

- Wearables such as Fitness monitors
- Small asset trackers such as Pet trackers & Bike trackers
- UAVs / Drones
- Agriculture Robotics
- Telematics devices

3. General data



Product Name	Admotus
Part Number	SRCG091
Frequency	1559 - 1610MHz
Polarization	Linear
Operating Temperature	-40°C to 125°C
Impedance With Matching	50 Ω
Weight	<0.1g
Antenna Type	SMD
Dimensions	1.0 x 0.5 x 0.5 (mm)
Footprint Area	7 x 15 (mm)

4. Part number

ADMOTUS
SRCG091



5. RF characteristics

Frequency	1559 – 1610 MHz
Peak Gain	0.9dBi
Average Gain	-2.6dB
Average Efficiency	53%
Maximum Return Loss	-11.5dB
Maximum VSWR	1.8:1

*All data measured on Antenova's evaluation PCB
Part No. SRCG091-EVB-1*

6. RF performance

6.1. Return loss

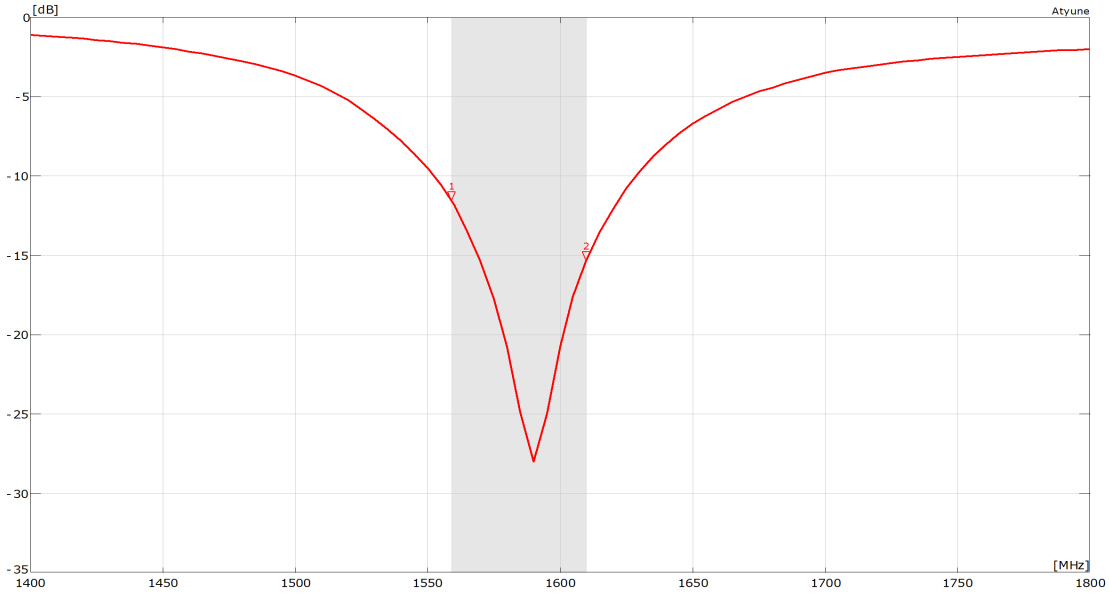

6.2. VSWR

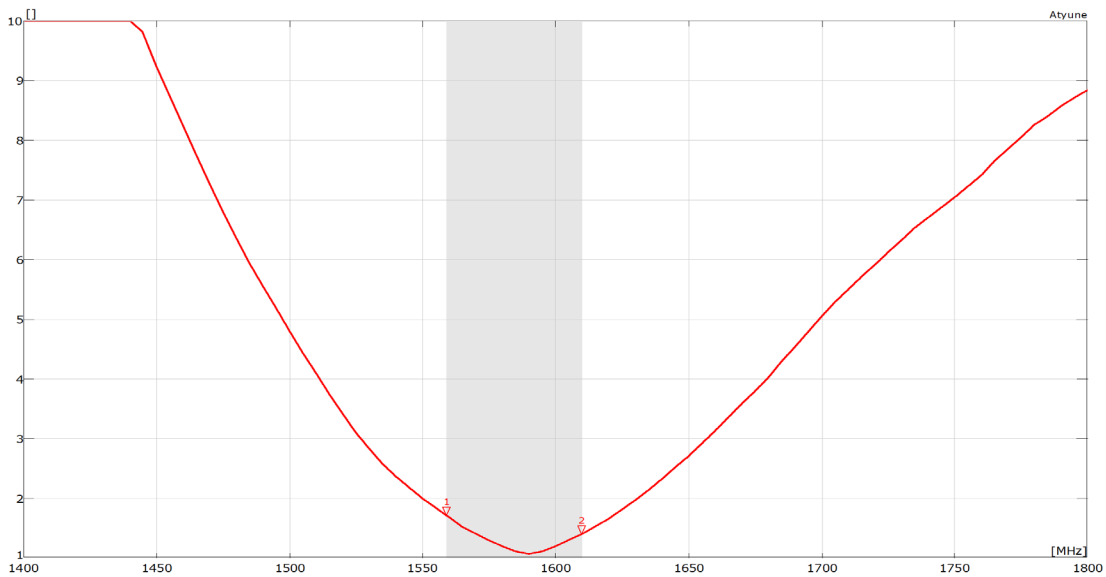

All data measured on Antenova's evaluation PCB
Part No. SRCG091-EVB-1

6.3. Efficiency

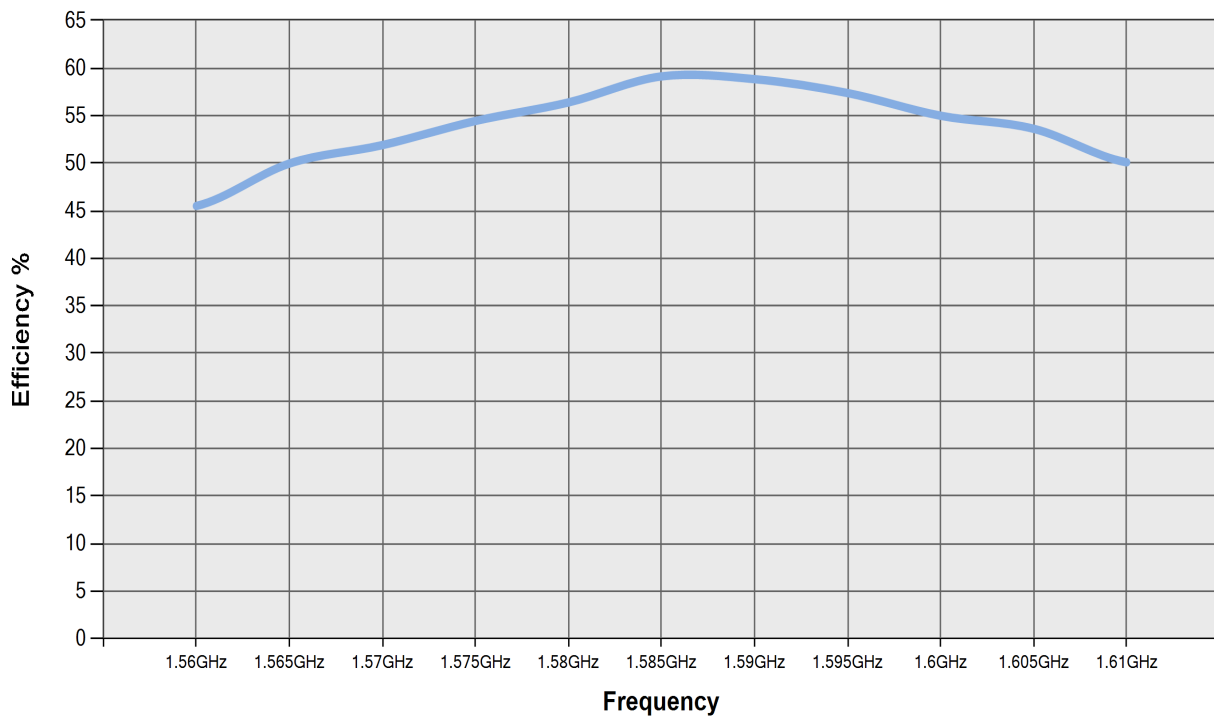

*All data measured on Antenova's evaluation PCB
Part No. SRCG091-EVB-1*

6.4. Antenna patterns

6.4.1. 1575MHz

3D pattern at 1575MHz

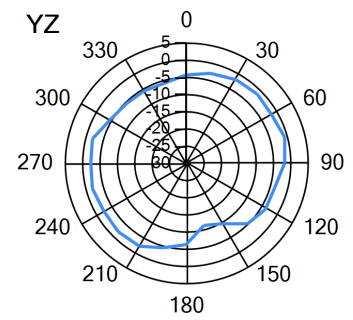
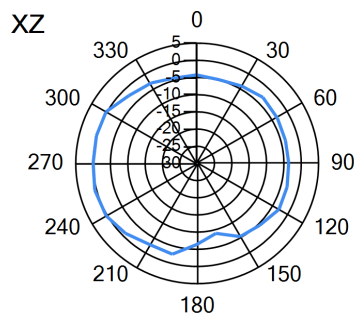
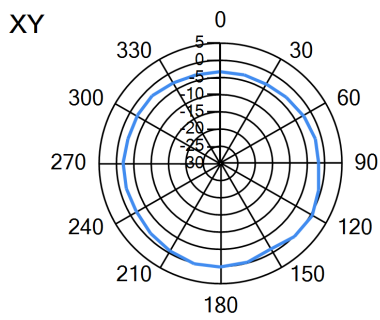
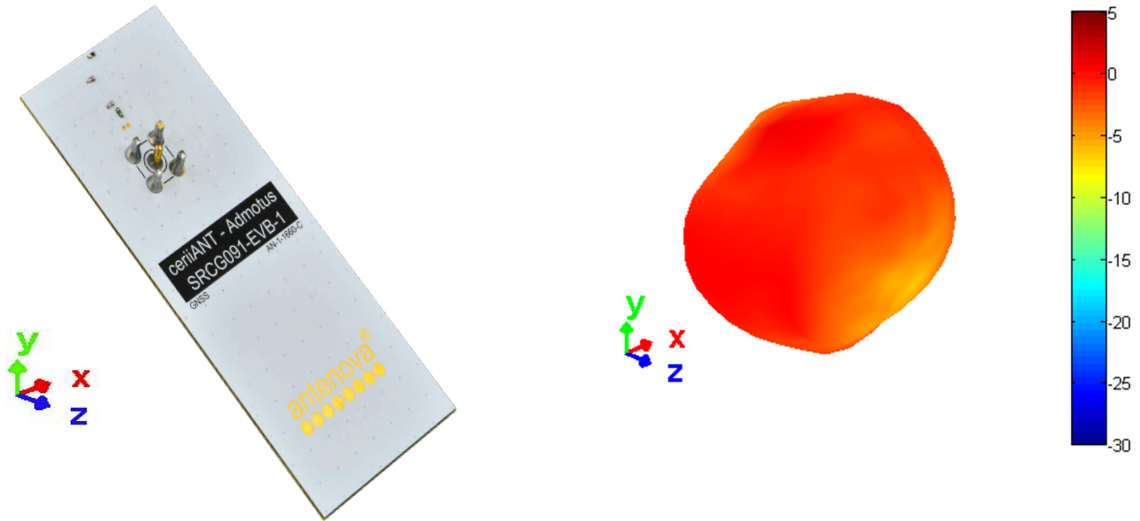

— 1.575GHz

7. Antenna dimensions

7.1. Antenna dimensions

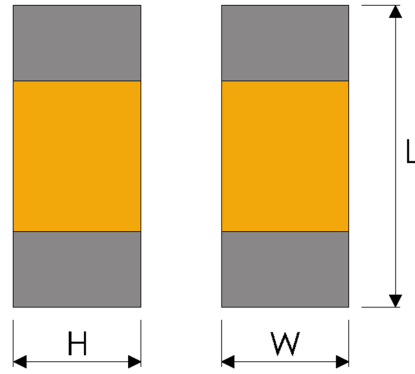

Top view

L	W	H
1.0 ±0.1	0.5 ±0.1	0.5 ±0.1

All dimensions in (mm)

7.2. Antenna footprint

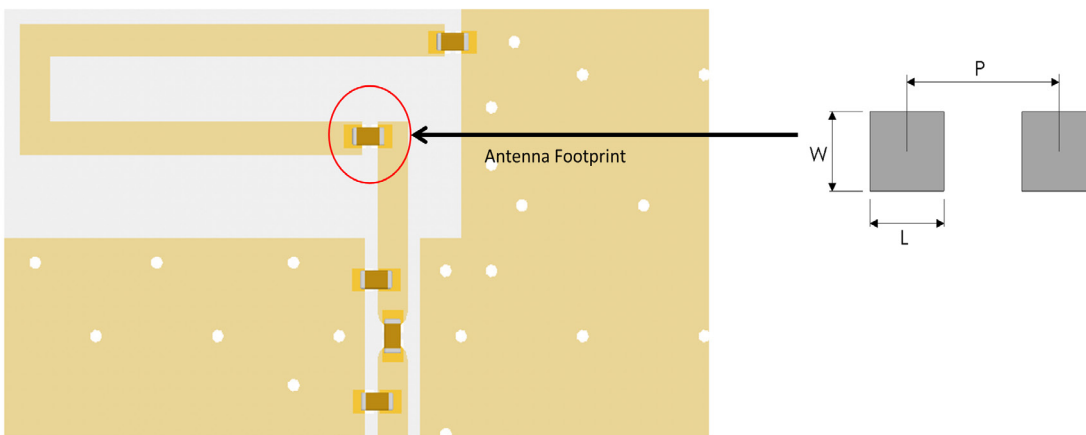

L	W	P
0.5 ±0.1	0.5 ±0.1	0.9 ±0.1

All dimensions in (mm)

8. Schematic

The circuit symbol for the antenna is shown below.

NAME	DESCRIPTION
Admotus (SRCG091)	Antenna
T1	Tuning Component
Pi Network	Antenna matching network

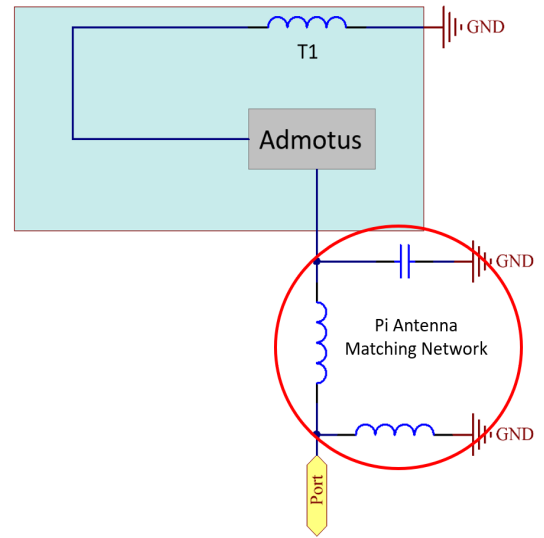

9. Host PCB footprint

The recommended host PCB footprint is below.

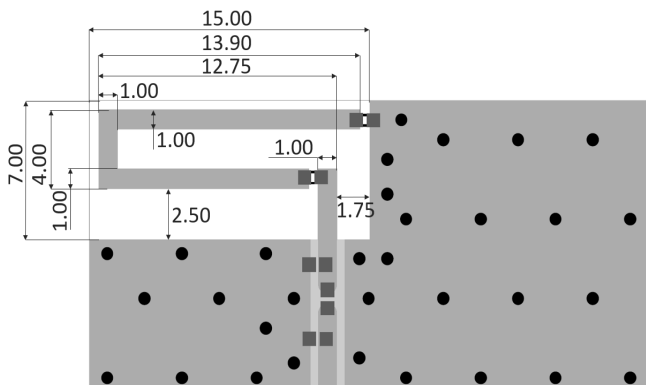

Antenna clearance area = 7.0mm x 15mm

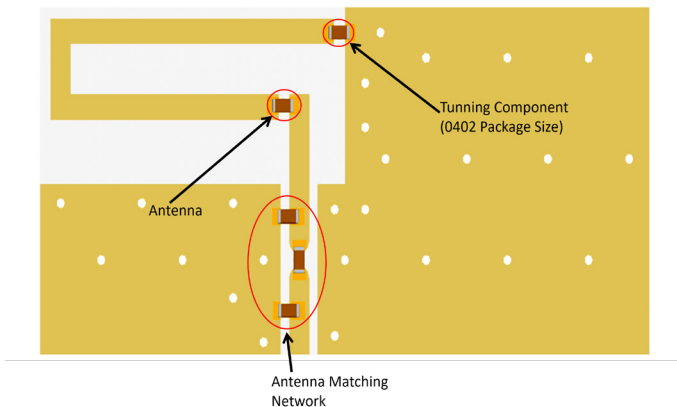

10. Electrical interface

10.1. Transmission line

All transmission lines should be designed to have a characteristic impedance of 50Ω.

- The length of each transmission lines should be kept to a minimum
- All other parts of the RF system like transceivers, power amplifiers, etc, should also be designed to have a 50 Ω impedance

A co-planar transmission line can be designed using an online transmission line calculator tool, such as:

<https://blog.antenova.com/rf-transmission-line-calculator>

The PCB thickness, copper thickness and substrate dielectric constant are entered, then the tool calculates the transmission line width and gaps on either side of the track to give a 50 Ω impedance.

10.2. Matching circuit

The antenna requires a matching circuit that must be optimized for each product. The matching circuit will require up to three components and the following circuit should be designed into the host PCB. Not all components may be required but should be included as a precaution. The matching network should be placed close to the antenna feed to ensure it is optionally effective in tuning the antenna.

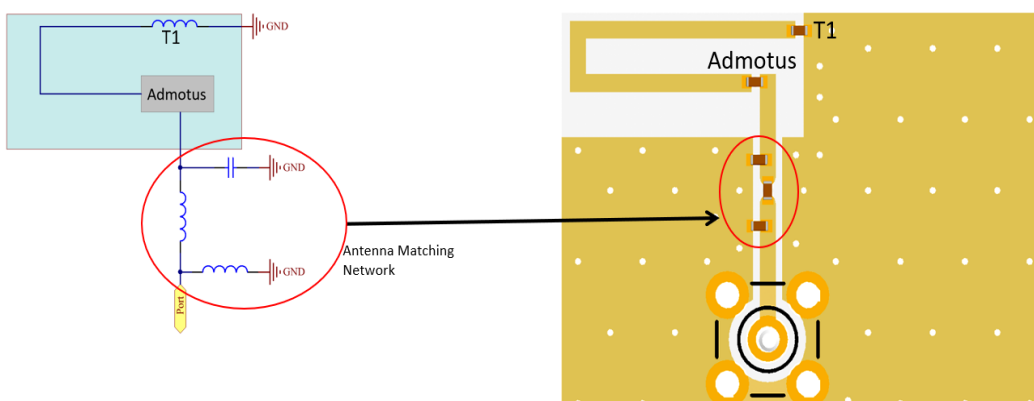

11. Antenna integration guide

We recommend the following during the design phase to maximise antenna performance and minimize noise:

- Minimum 4 layer PCB
- Route signals and power internally where possible
- Flood all layers with ground
- Knit ground on all layers together with plenty of vias

Follow placement guidance carefully. Antenova provide technical support to help you with your design, and also provide design assistance on PTCRB certification. Register for an account on <https://ask.antenova.com/> to access technical support.

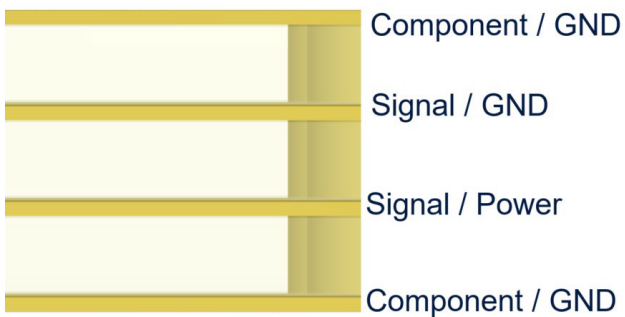

11.1.1. Antenna placement

The antenna should be placed in the best suited position to effectively radiate whichever the PCB size used, it can be in either left hand or right hand side placement.



EVB clearance placement

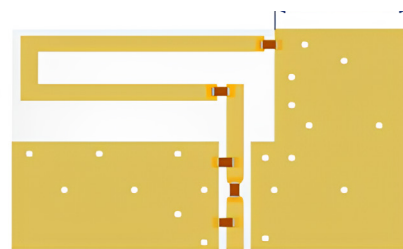

Left placement



Right placement

11.2. Host PCB Clearance

The host PCB must be designed using the PCB footprint shown with the correct clearances. An example of the PCB layout shows the antenna footprint. Please note this clearance area is critical to the performance of the antenna and must be applied through all layers of the PCB.

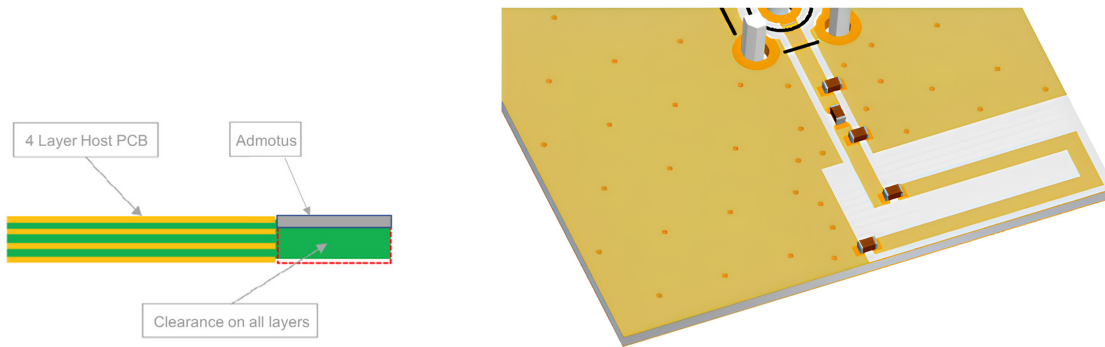

12. Reference board

A reference board is used for evaluating the antenna SRCG091 and it includes a SMA female connector. (part number SRCG091-EVB-1)

To order a reference board please see antenna.com



12.1. Reference board matching circuit

DESIGNATOR	TYPE	VALUE	Description
Admotus	Antenna	Antenova	1575MHz
T1	Inductor	0 ohm	
L1	Not Fitted		
L2	Inductor	3.3nH	Murata LQG15HN series
C1	Capacitor	1.5pF	Murata GJM15 series

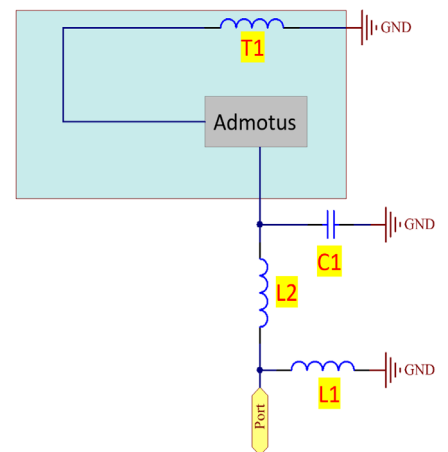

12.2. Reduced size ground plane

The reference board has a length of 70mm to get the optimal performance. Many designs require smaller dimensions, there some measurements were made of the efficiency with shorter PCB length. Measurements were made with recommended matching networks.

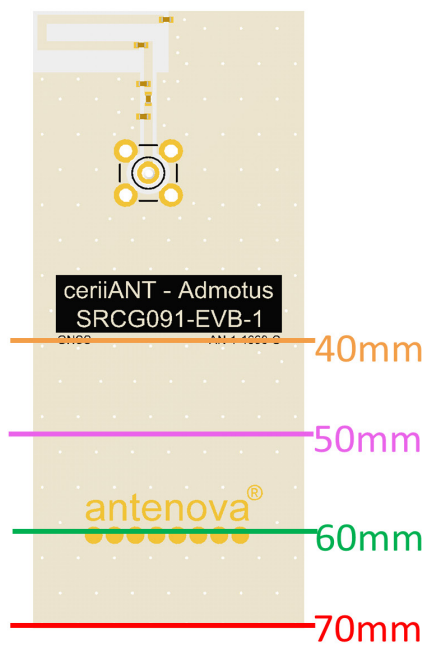
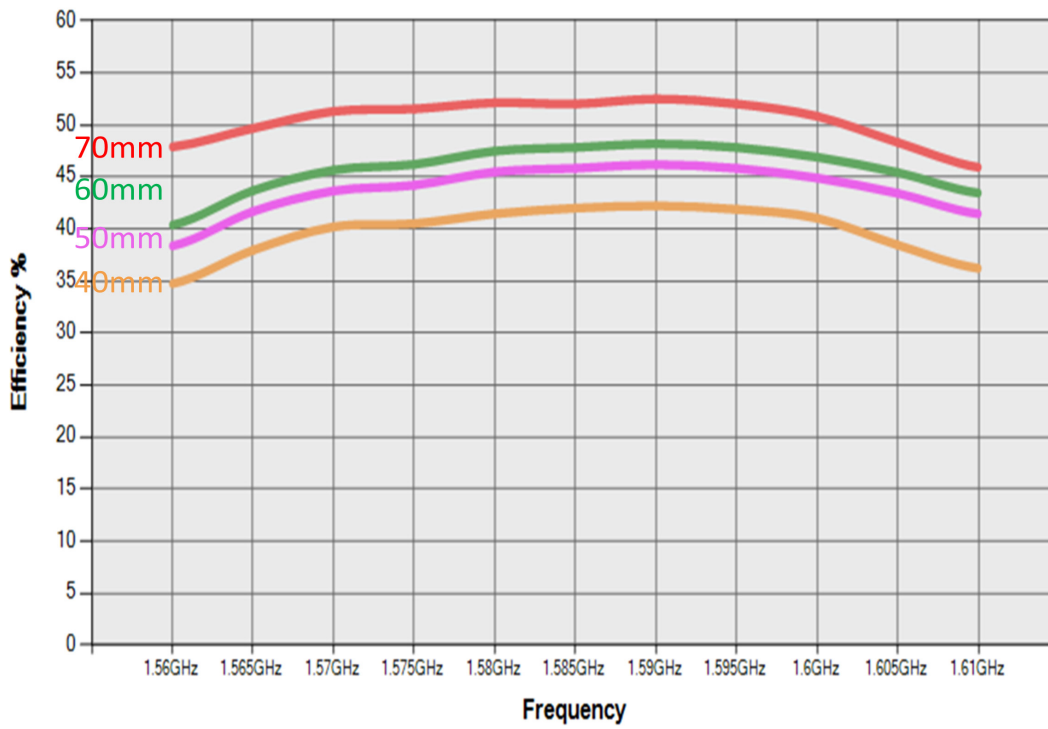

12.3. Host PCB size

As with all Antenova antennas Admotus requires the ground plane of the PCB in order to radiate effectively. To illustrate this, the Admotus antenna was used with the Antenova M20071 module for active 'open sky' testing .

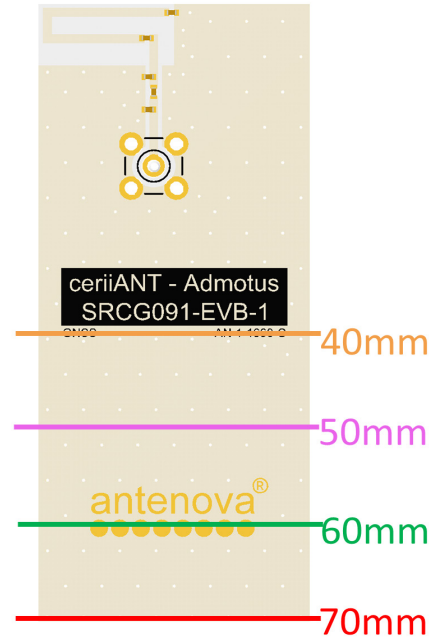

70x30 (mm)	TIME TO FIRST FIX (S)	AVG 4 SV (CN)	PEAK C/N	FIXED SV NUMBER
1 st test	33	43.25	49	12
2 nd test	34	43.75	46	12
3 rd test	30	43.25	46	13
60x30 (mm)	TIME TO FIRST FIX (S)	AVG 4 SV (CN)	PEAK C/N	FIXED SV NUMBER
1 st test	31	43.5	48	12
2 nd test	31	43.75	46	12
3 rd test	32	43.5	47	12
50x30 (mm)	TIME TO FIRST FIX (S)	AVG 4 SV (CN)	PEAK C/N	FIXED SV NUMBER
1 st test	36	42	45	12
2 nd test	30	42.25	45	12
3 rd test	33	42.75	46	12
40x30 (mm)	TIME TO FIRST FIX (S)	AVG 4 SV (CN)	PEAK C/N	FIXED SV NUMBER
1 st test	36	43	47	12
2 nd test	33	42.5	46	11
3 rd test	32	42.25	46	11

All data measured with Admotus SRCG091-EVB-1 & M20071-EVB-1

13. Soldering

This antenna is suitable for lead free soldering. The reflow profile should be adjusted to suit the device, oven and solder paste, while observing the following conditions:

- For leaded soldering, the maximum temperature should not exceed 240 °C
- For lead free soldering, a maximum temperature of 255 °C for no more than 20 seconds is permitted.
- The antenna should not be exposed to temperatures exceeding 120 °C more than 3 times during the soldering process.

14. Hazardous material regulation conformance

The antenna has been tested to conform to RoHS and REACH requirements. A certificate of conformance is available from Antenova's website.

15. Packaging

15.1. Optimal storage conditions

TEMPERATURE	-10°C to 40°C
HUMIDITY	Less than 75% RH
SHELF LIFE	24 Months
STORAGE PLACE	Away from corrosive gas and direct sunlight
PACKAGING	Reels should be stored in unopened sealed manufacturer's plastic packaging.
MSL LEVEL	1

Note: Storage of open reels of antennas is not recommended due to possible oxidization of pads on antennas. If short term storage is necessary, then it is highly recommended that the bag containing the antenna reel is re-sealed and stored in conditions as described in the table above.

The shelf life of the antenna is 2 years provided the factory seal on the package has not been broken.

15.2. Tape

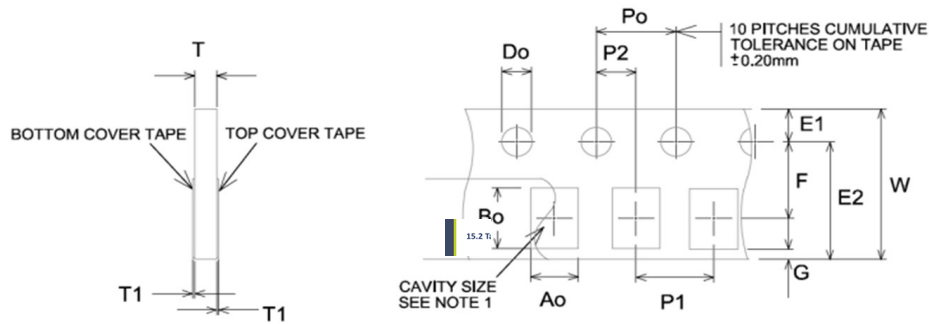

All dimensions in mm

Do	E1	E2	F	G	Po
1.50±0.1	1.75±0.1	6.25±0.1	3.50±0.05	0.75 min	4.00±0.1

P1	P2	T	T1	W	Ao & Bo
4.00±0.1	2.00±0.05	1.10 max	0.1 max	8.00±0.3	See note 1

Notes:

The cavity defined by Ao, Bo, and T shall be configured to provide sufficient clearance surrounding the antenna so that:

- a) The component does not protrude beyond either surface of the carrier tape.
- b) The component can be removed from the cavity in a vertical direction without mechanical restriction after the top cover tape has been removed.
- c) Rotation of the component is limited to 20° maximum.
- d) Lateral movement of the component is restricted to 0.5mm maximum.

15.3. Reel dimensions

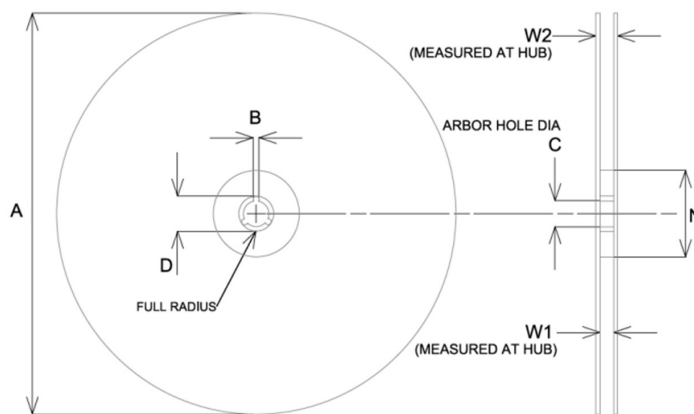

All dimensions in mm

A	B	C	D	W1	W2
178+/-1mm	2.2+/-0.5mm	13.0±0.5	20.2(min)	9+/-0.5mm	11.4+/-0.5mm

Quantity	Leading Space	Trailing Space
10000 pcs /reel	390+/-1mm	390+/-1mm

15.4. Box dimensions

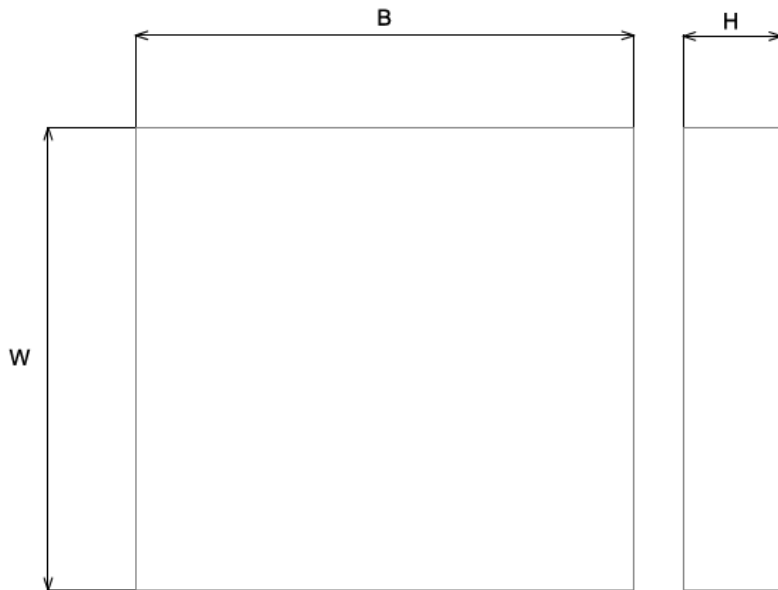

WIDTH (W)	BREADTH (B)	HEIGHT (H)
180mm	185mm	40mm

15.5. Bag properties

Reels are supplied in protective plastic packaging.

15.6. Information

Antenova Limited
 www.antenova.com
 Description: Admotus 
 Part Number: SRCG091 
 Qty: 10,000 pcs 
 Date Code: YYWW 



Quality statements

Antenova's products conform to REACH and RoHS legislation. For our statements regarding these and other quality standards, please see antenova.com.



Antenova reserves all rights to the contents of this document. Antenova gives no warranties based solely on the accuracy or completeness of the contents of this document and reserves the right to make changes to the specifications of the products described herein at any time and without notice.

Datasheet version

1.01 release September 15 2023

Antenna design, integration and test resources

Product designers – the details contained in this datasheet will help you to complete your embedded antenna design. Please follow our technical advice carefully to obtain optimum antenna performance.

We aim to support our customers to create high performance wireless products. You will find a wealth of design resources, calculators and case studies to aid your design on our website.

Antenova's design laboratories are equipped with the latest antenna design tools and test chambers. We provide antenna design, test and technical integration services to help you complete your design and obtain the required certifications.

If you cannot find the antenna you require in our product range, please contact us to discuss creating a custom antenna to meet your exact requirements.

Share knowledge with **RF experts** around the world.
ask.antenova is a global forum for designers and engineers working with wireless technology.

[VISIT ASK.ANTENOVA](https://www.ask.antenova.com)

Visit [antenova.com](https://www.antenova.com)

Order antenna samples and evaluation boards, and read our antenna resources

[VISIT ANTENOVA.COM](https://www.antenova.com)

Request a volume quotation for antennas:

sales@antenova.com

Global headquarters

Antenova Ltd, 2nd Floor Titan Court, 3 Bishop Square, Hatfield, AL10 9NA

+44 (0) 1707 927589

X-ON Electronics

Largest Supplier of Electrical and Electronic Components

Click to view similar products for [Antenna Development Tools](#) category:

Click to view products by [Antenova](#) manufacturer:

Other Similar products are found below :

[PCSD.06.A](#) [1002427-02](#) [1004796-01](#) [YC0010AAEVB](#) [1001013-02](#) [1005454-01](#) [1004795-01](#) [1002436-01](#) [ACR1004A-EVB](#) [RAC00024-EVB](#) [RAC00245-EVB](#) [ACR1004GC-EVB](#) [W3012-K](#) [W3006-K](#) [SPD.25A](#) [74889100TB](#) [A10192-U1](#) [DTAD.01.A.50](#) [SR4C033-EVB-1](#) [AEK-LTE-CER](#) [IOT-K](#) [SR4W035-EVB-1](#) [W3010-K](#) [LORA-K](#) [ISM-K](#) [REFLECTOR-EVB-1](#) [ACAG0201-2450-EVB](#) [ACAG0301-15752450-EVB](#) [ACAG0301-1575-EVB](#) [ACAG0301-24505500-EVB](#) [ACAG0301-5500-EVB](#) [ACAG0801-2450-EVB](#) [ACAG1204-433-EVB](#) [ACAG1204-868-EVB](#) [ACAG1204-915-EVB](#) [ACAR0301-SW2-EVB](#) [ACAR3005-C2WB-EVB](#) [ACAR3005-S824-EVB](#) [ACAR3705-S698-EVB](#) [ACAR4008-S698-EVB](#) [ACR0301U-EVB](#) [ACR1504I3-EVB-A](#) [ACR1504I3-EVB-S](#) [ACR2005I4-EVB](#) [ACR4006X-EVB](#) [PRO-EB-450](#) [PRO-EB-453](#) [PRO-EB-472](#) [PRO-EB-476](#) [PRO-EB-550](#)