

DATASHEET

Silvai

SRCI024 • ceriANT[®]



Features

- Ceramic Antenna for 868MHz & 915MHz ISM bands
- Low cost ceramic antenna with high antenna efficiency
- Good coverage area for Wireless Sensor Networks
- Ceramic antennas are resistant to detuning from nearby materials

Contents

1.	Description	2
2.	Applications	2
3.	General data	2
4.	Part number	3
5.	RF characteristics	3
6.	RF performance	4
6.1.	Return loss	4
6.2.	VSWR	4
6.3.	Efficiency	5
6.4.	Antenna patterns	6
7.	Antenna dimensions	8
7.1.	Antenna dimensions	8
7.2.	Antenna footprint	8
8.	Schematic	9
9.	Host PCB footprint	9
10.	Electrical interface	10
10.1.	Transmission line	10
10.2.	Matching circuit	10
11.	Antenna integration guide	11
11.1.	Antenna placement	11
11.2.	Host PCB Clearance	12
12.	Reference board	13
12.1.	Reference board matching circuit	13
13.	Soldering	14
14.	Hazardous material regulation conformance	14
15.	Packaging	14

1. Description

Silvai is a ceramic antenna that is fitted on a PCB. The PCB layout together with the matching circuit for both ISM bands (863 – 870MHz and 902 – 928MHz) is provided. Antenna clearance area for the PCB layout is 30mm x 11.5mm

2. Applications

- Suitable for all ISM applications
- Uses ISM protocols such as LoRa, Zigbee, Matter and Sigfox

3. General data



Frequency	868 - 915MHz
Polarization	Linear
Operating Temperature	-40°C to 125°C
Impedance With Matching	50 Ω
Weight	<0.015g
Antenna Type	SMD
Dimensions	1.0 x 0.5 x 0.5 (mm)
Footprint Area	11.5 x 30 (mm)

4. Part number

SILVAI
SRCI024



5. RF characteristics

Frequency	863 – 870 MHz	902 – 928 MHz
Peak Gain	0.3dBi	1.4dBi
Average Gain	-2.6dB	-1.5dB
Average Efficiency	55%	70%
Maximum Return Loss	-17.7dB	-7.6dB
Maximum VSWR	1.7:1	2.4:1

All data measured on Antenna's evaluation PCB Part No. SRCI024-EVB-1

6. RF performance

6.1. Return loss

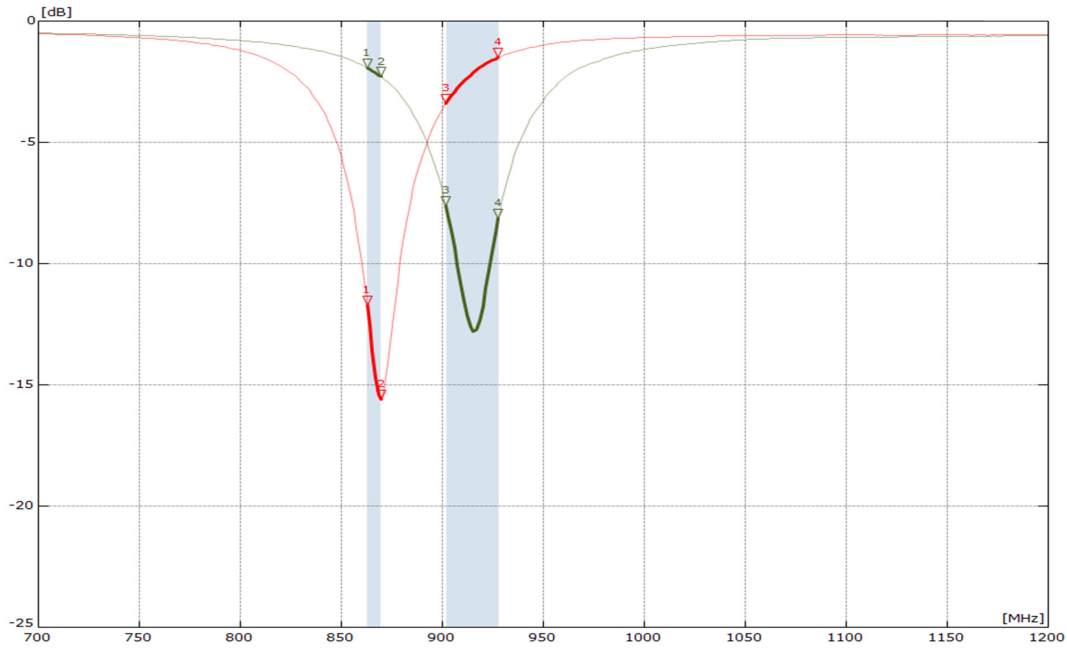

6.2. VSWR

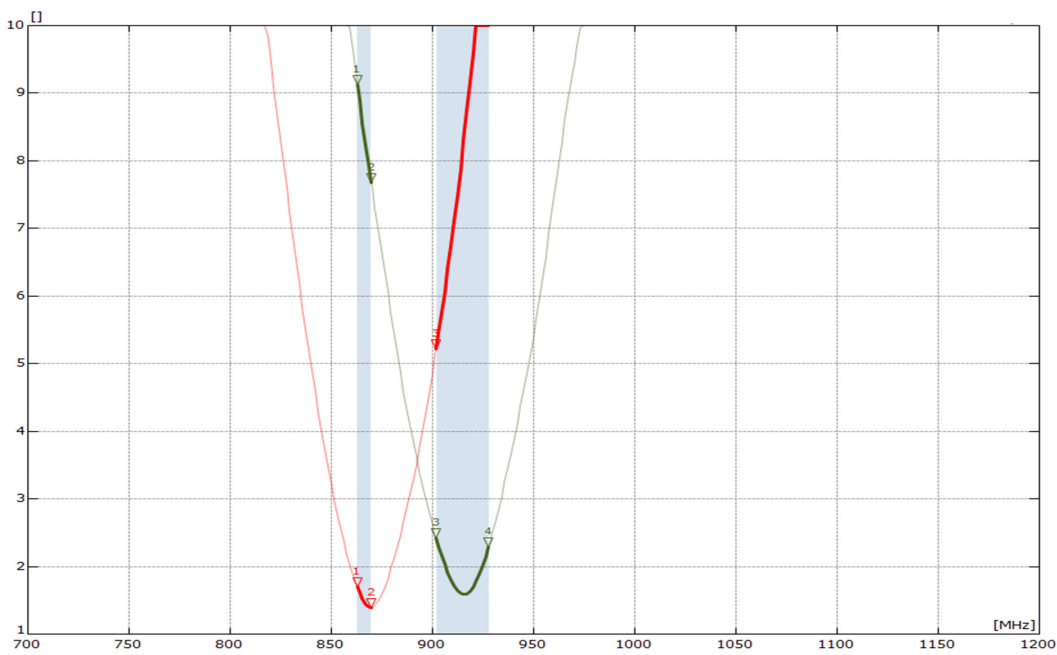

All data measured on Antenna's evaluation PCB Part No. SRCI024-EVB-1

6.3. Efficiency

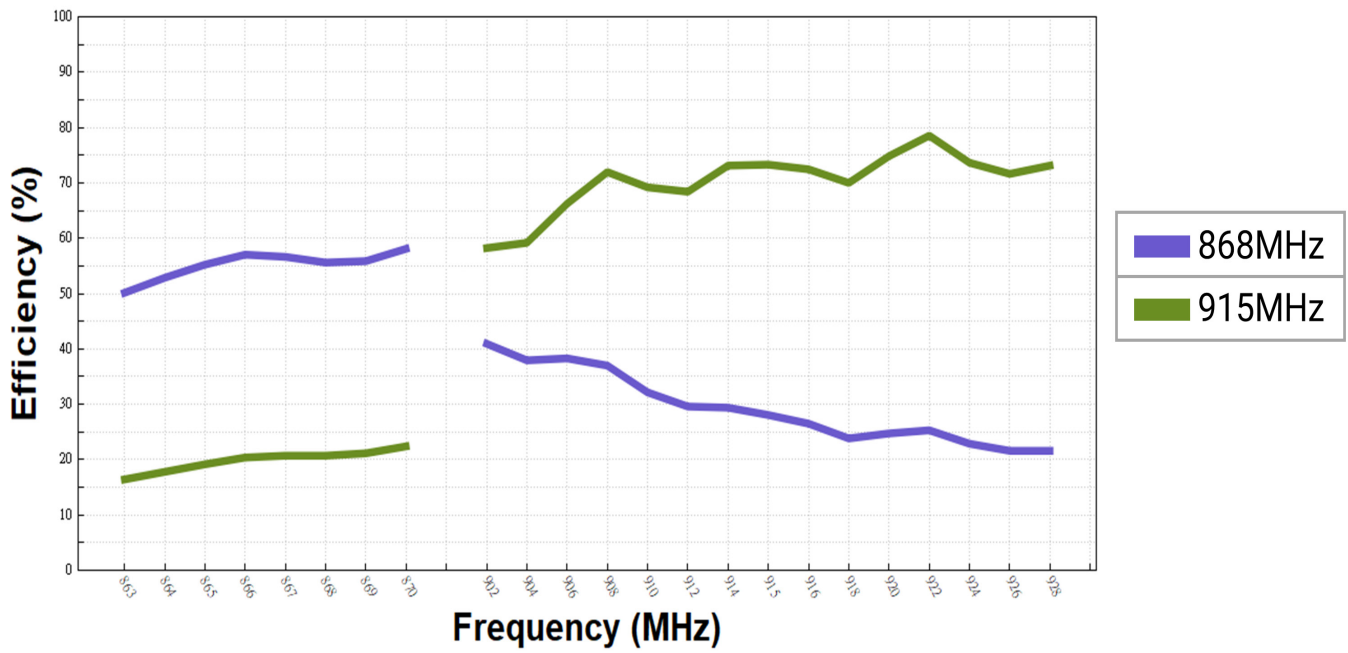

All data measured on Antenova's evaluation PCB Part No. SRCI024-EVB-1

6.4. Antenna patterns

6.4.1. 868MHz

3D pattern at 868MHz

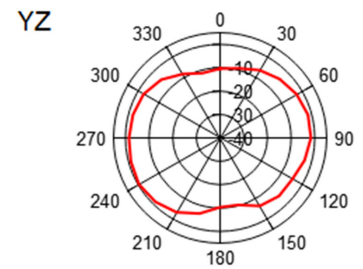
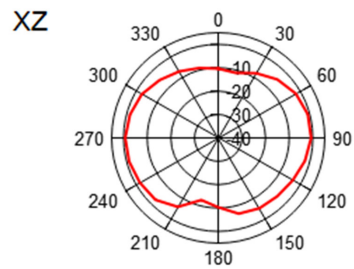
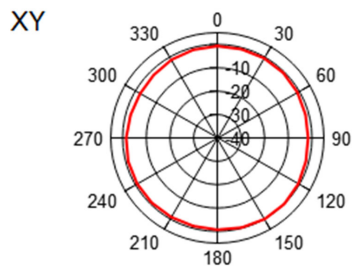
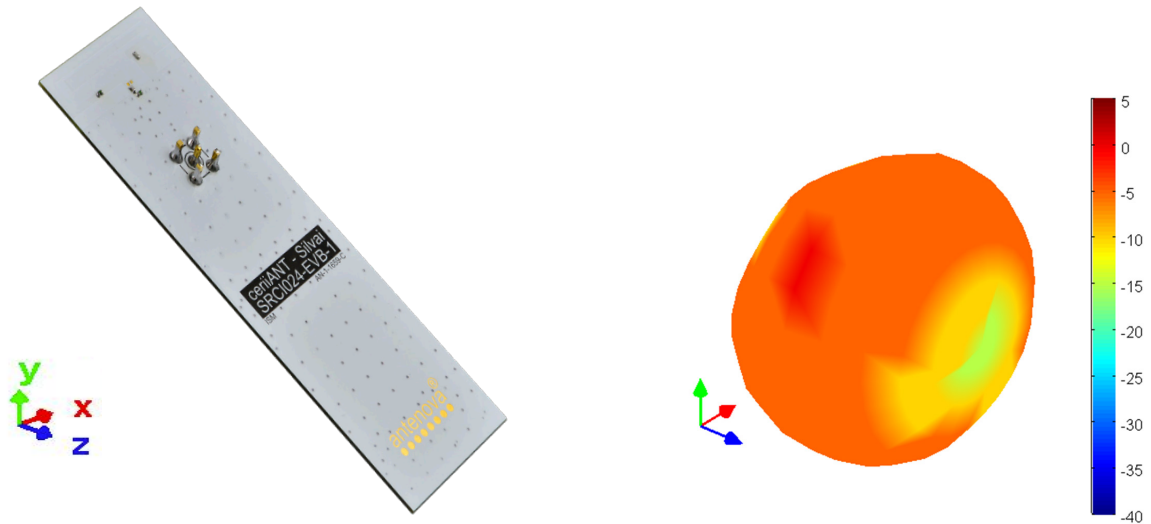

6.4.2. 915MHz

3D pattern at 915MHz

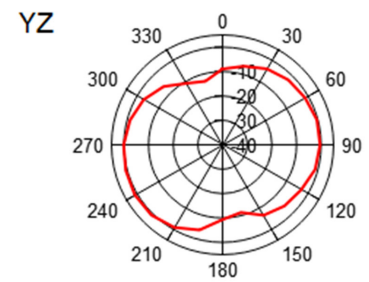
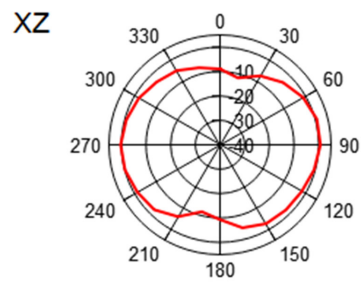
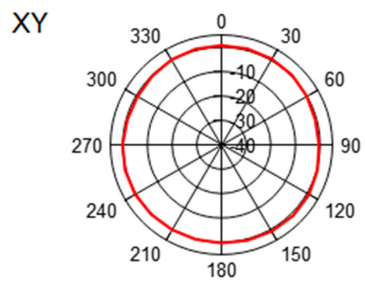
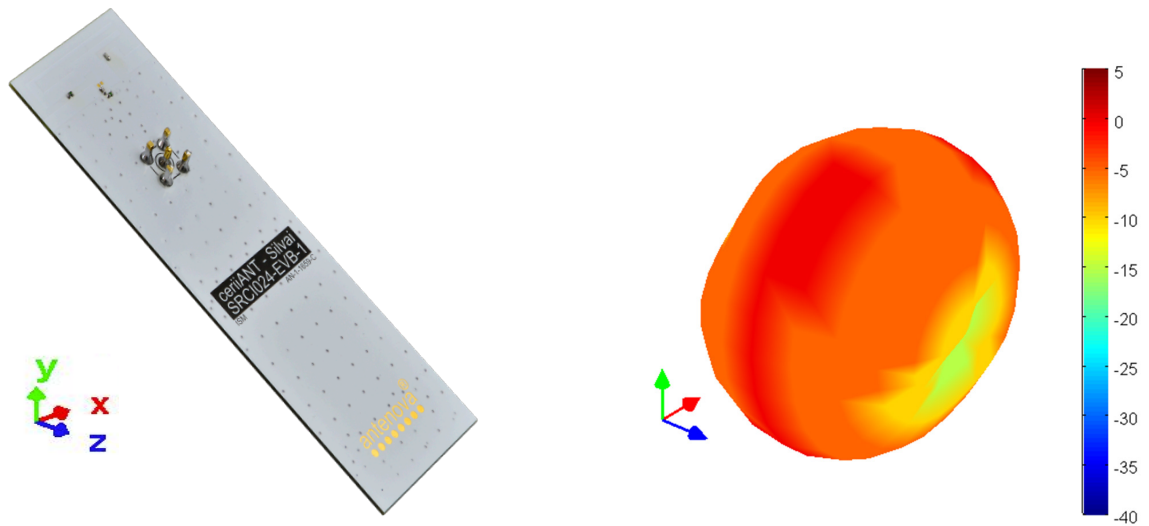

7. Antenna dimensions

7.1. Antenna dimensions

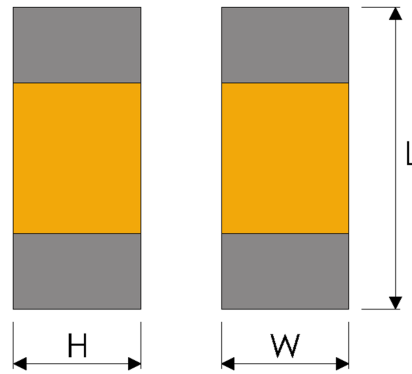

Top view

L	W	H
1.0 ±0.1	0.5 ±0.1	0.5 ±0.1

All dimensions in (mm)

7.2. Antenna footprint

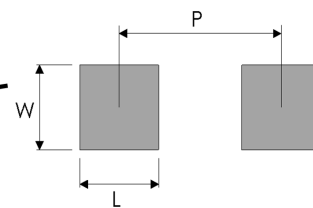
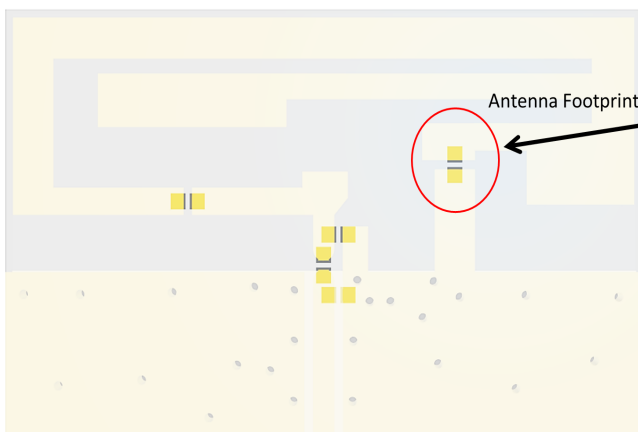

L	W	P
0.5 ±0.1	0.5 ±0.1	0.9 ±0.1

All dimensions in (mm)

8. Schematic

The circuit symbol for the antenna is shown below.

NAME	DESCRIPTION
Silvai (SRCI024)	Antenna
T1	Tuning Component
Pi Network	Antenna matching network

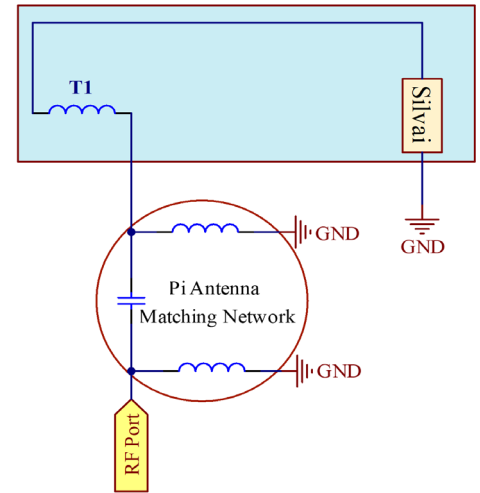

9. Host PCB footprint

The recommended host PCB footprint is below.

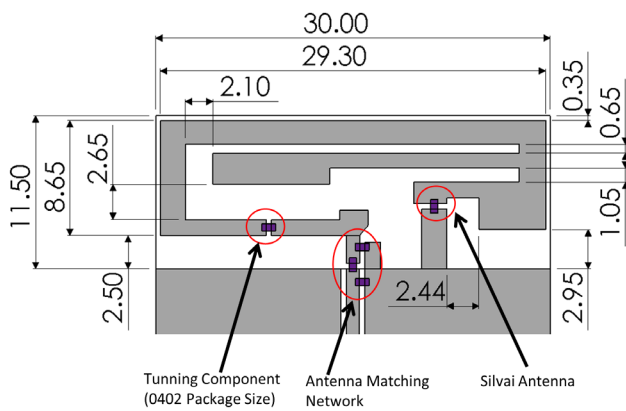

Antenna clearance area = 11.5mmX30mm

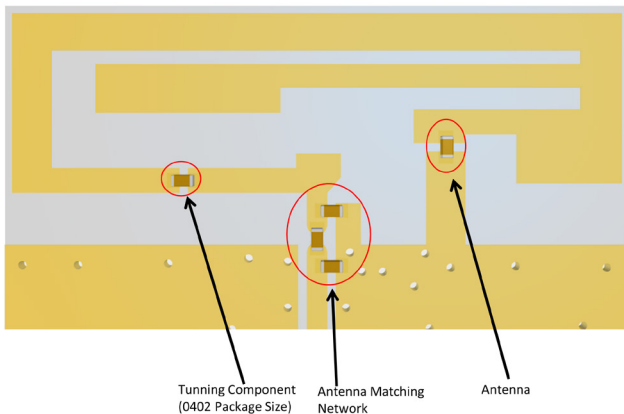

10. Electrical interface

10.1. Transmission line

All transmission lines should be designed to have a characteristic impedance of 50Ω.

- The length of each transmission lines should be kept to a minimum
- All other parts of the RF system like transceivers, power amplifiers, etc, should also be designed to have a 50 Ω impedance

A co-planar transmission line can be designed using an online transmission line calculator tool, such as:

<https://blog.antenova.com/rf-transmission-line-calculator>

The PCB thickness, copper thickness and substrate dielectric constant are entered, then the tool calculates the transmission line width and gaps on either side of the track to give a 50 Ω impedance.

10.2. Matching circuit

The antenna requires a matching circuit that must be optimized for each product. The matching circuit will require up to three components and the following circuit should be designed into the host PCB. Not all components may be required but should be included as a precaution. The matching network should be placed close to the antenna feed to ensure it is optionally effective in tuning the antenna.

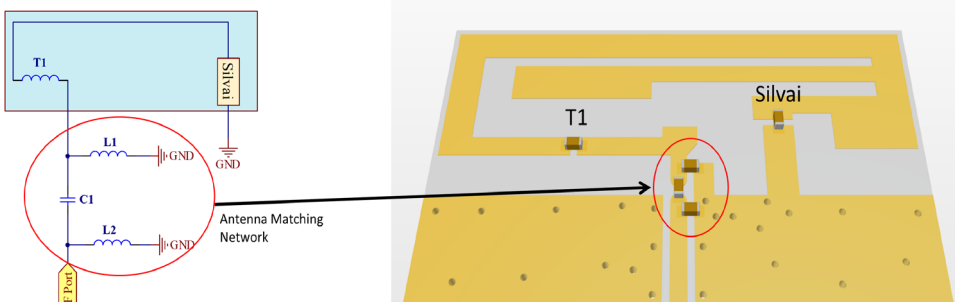

11. Antenna integration guide

We recommend the following during the design phase to maximise antenna performance and minimize noise:

- Minimum 4 layer PCB
- Route signals and power internally where possible
- Flood all layers with ground
- Knit ground on all layers together with plenty of vias

Follow placement guidance carefully. Antenova provide technical support to help you with your design, and also provide design assistance on PTCRB certification. Register for an account on <https://ask.antenova.com/> to access technical support.

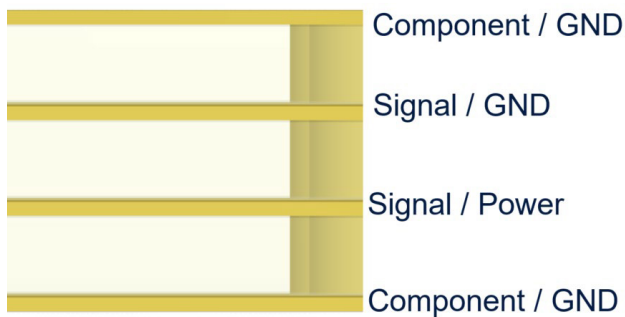

11.1. Antenna placement

The antenna should be placed in the best suited position to effectively radiate. Whichever the PCB size used, it can be in either full clearance, or right hand side, or left hand side placement.

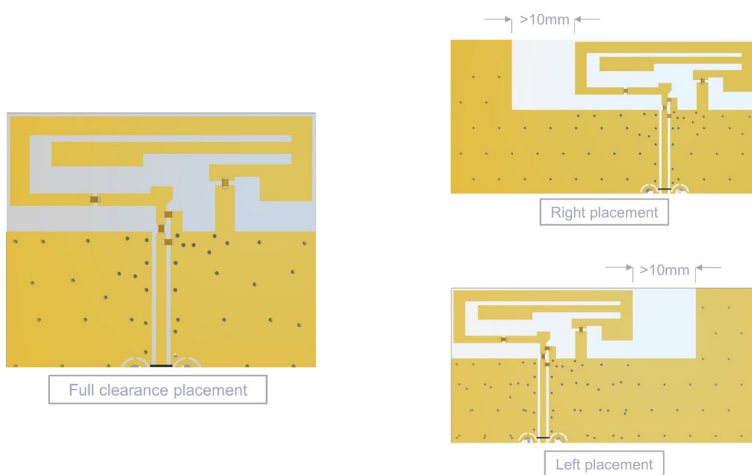

11.2. Host PCB Clearance

The host PCB must be designed using the PCB footprint shown with the correct clearances. An example of the PCB layout shows the antenna footprint. Please note this clearance area is critical to the performance of the antenna and must be applied through all layers of the PCB.

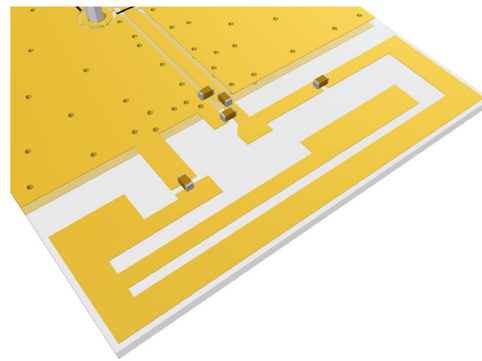
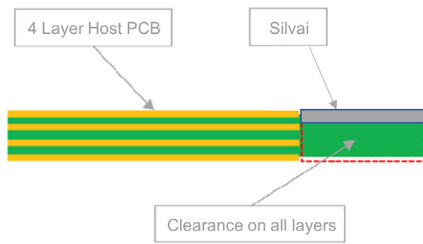

All dimensions in (mm)

12. Reference board

A reference board is used for evaluating the antenna SRCI024 and it includes a SMA female connector. (part number SRCI024-EVB-1)

To order a reference board please see antenna.com



12.1. Reference board matching circuit

DESIGNATOR	TYPE	VALUE	Description
Silvai	Antenna	Antenova	868MHz
T1	Inductor	3.6nH	Murata LQG15HN series
L1	Not Fitted		
L2	Inductor	4.7nH	Murata LQG15HN series
C1	Capacitor	3.9pF	Murata GJM15 series

DESIGNATOR	TYPE	VALUE	Description
Silvai	Antenna	Antenova	915MHz
T1	Inductor	1.0nH	Murata LQG15HN series
L1	Not Fitted		
L2	Inductor	4.3nH	Murata LQG15HN series
C1	Capacitor	3.6pF	Murata GJM15 series

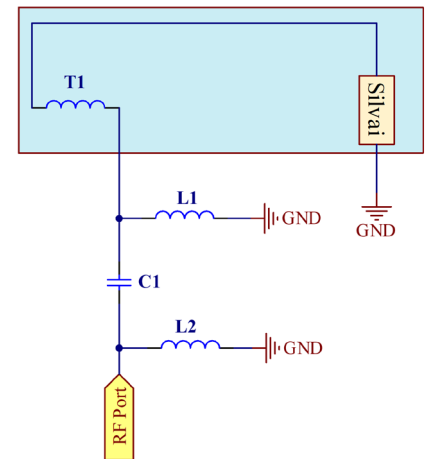

12.2. Reduced size ground plane

The reference board has a length of 95mm to get the optimal performance. Many designs require smaller dimensions, there some measurements were made of the efficiency with shorter PCB length. Measurements were made with recommended matching networks for 868 and 915MHz.

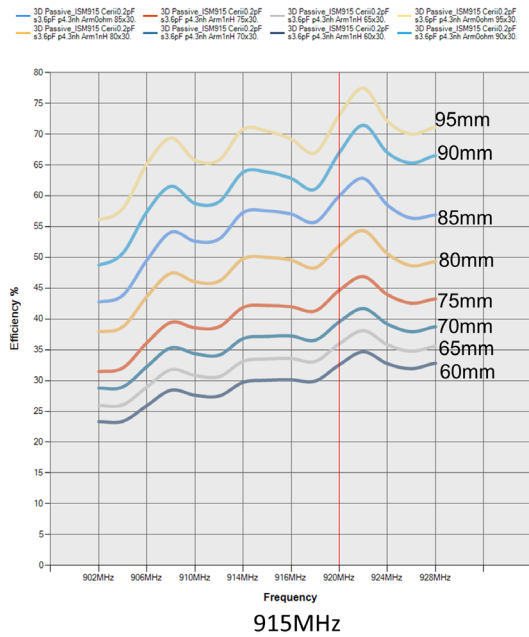
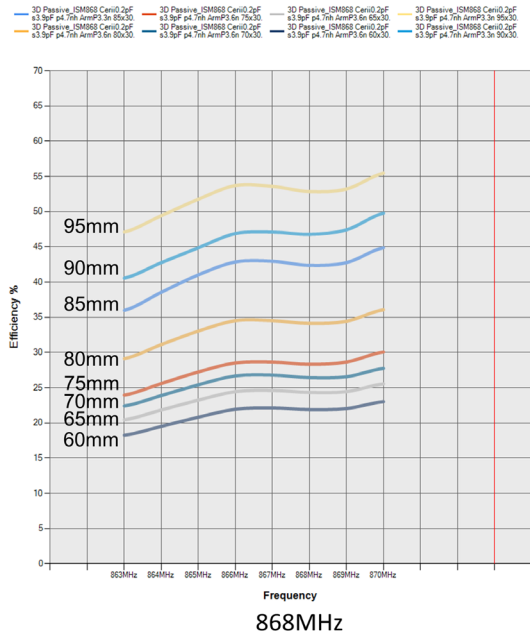

13. Soldering

This antenna is suitable for lead free soldering. The reflow profile should be adjusted to suit the device, oven and solder paste, while observing the following conditions:

- For leaded soldering, the maximum temperature should not exceed 240 °C.
- For lead free soldering, a maximum temperature of 255 °C for no more than 20 seconds is permitted.
- The antenna should not be exposed to temperatures exceeding 120 °C more than 3 times during the soldering process.

14. Hazardous material regulation conformance

The antenna has been tested to conform to RoHS and REACH requirements. A certificate of conformance is available from Antenova's website.

15. Packaging

15.1. Optimal storage conditions

TEMPERATURE	-10°C to 40°C
HUMIDITY	Less than 75% RH
SHELF LIFE	24 Months
STORAGE PLACE	Away from corrosive gas and direct sunlight
PACKAGING	Reels should be stored in unopened sealed manufacturer's plastic packaging.
MSL LEVEL	1

Note: Storage of open reels of antennas is not recommended due to possible oxidization of pads on antennas. If short term storage is necessary, then it is highly recommended that the bag containing the antenna reel is re-sealed and stored in conditions as described in the table above.

The shelf life of the antenna is 2 years provided the factory seal on the package has not been broken.

15.2. Tape characteristics

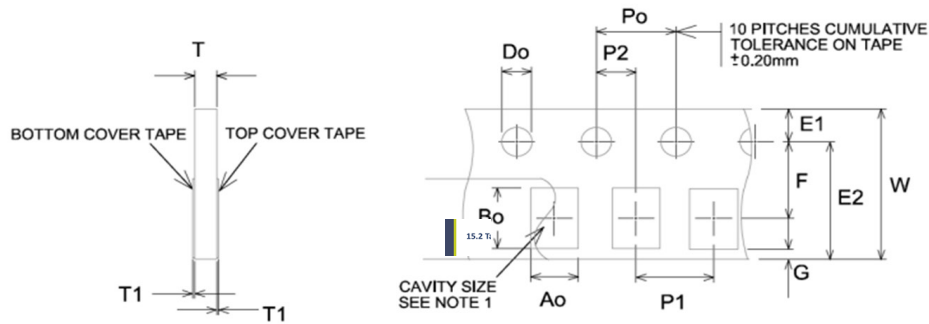

All dimensions in mm

Do	E1	E2	F	G	Po
1.50±0.1	1.75±0.1	6.25±0.1	3.50±0.05	0.75 min	4.00±0.1

P1	P2	T	T1	W	Ao & Bo
4.00±0.1	2.00±0.05	1.10 max	0.1 max	8.00±0.3	See note 1

Notes:

The cavity defined by Ao, Bo, and T shall be configured to provide sufficient clearance surrounding the antenna so that:

- a) The component does not protrude beyond either surface of the carrier tape.
- b) The component can be removed from the cavity in a vertical direction without mechanical restriction after the top cover tape has been removed.
- c) Rotation of the component is limited to 20° maximum.
- d) Lateral movement of the component is restricted to 0.5mm maximum.

15.3. Reel dimensions

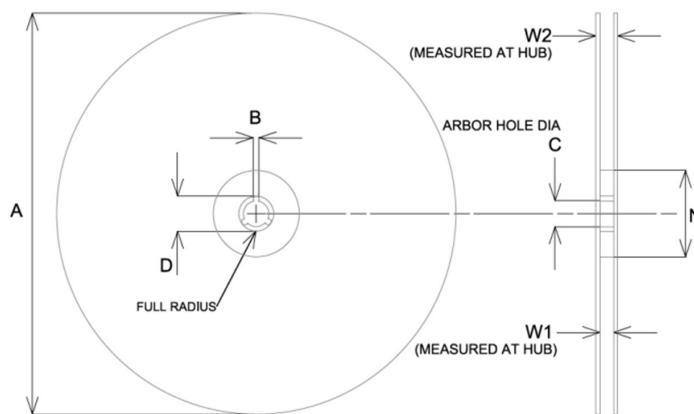

All dimensions in mm

A	B	C	D	W1	W2
178+/-1mm	2.2+/-0.5mm	13.0±0.5	20.2(min)	9+/-0.5mm	11.4+/-0.5mm

Quantity	Leading Space	Trailing Space
10000 pcs /reel	390+/-1mm	390+/-1mm

15.4. Box dimensions

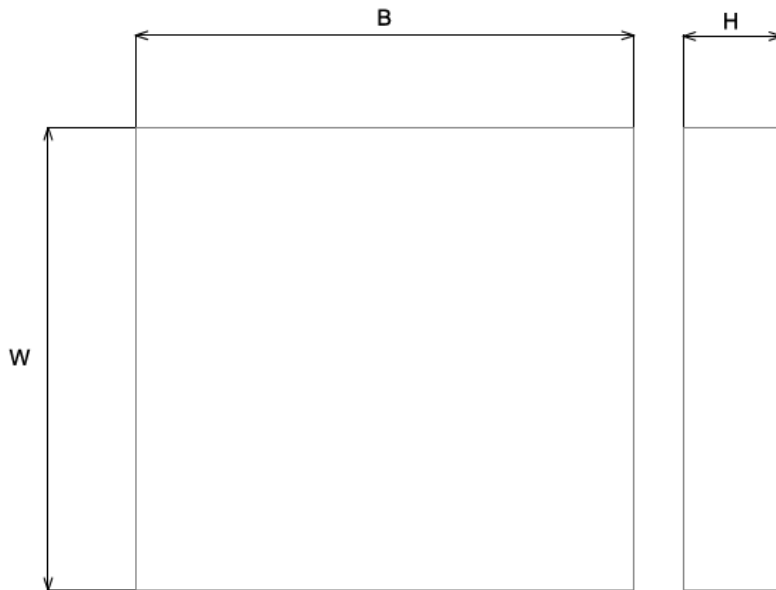

WIDTH (W)	BREADTH (B)	HEIGHT (H)
180mm	185mm	40mm

15.5. Bag properties

Reels are supplied in protective plastic packaging.

15.6. Reel label information

Antenova Limited
 www.antenova.com
 Description: Silvai
 Part Number: SRCI024
 Qty: 10,000 pcs
 Date Code: YYWW







Quality statements

Antenova's products conform to REACH and RoHS legislation. For our statements regarding these and other quality standards, please see [antenova.com](https://www.antenova.com).



Antenova reserves all rights to the contents of this document. Antenova gives no warranties based solely on the accuracy or completeness of the contents of this document and reserves the right to make changes to the specifications of the products described herein at any time and without notice.

Datasheet version

1.01 released May 30th 2023

Antenna design, integration and test resources

Product designers – the details contained in this datasheet will help you to complete your embedded antenna design. Please follow our technical advice carefully to obtain optimum antenna performance.

We aim to support our customers to create high performance wireless products. You will find a wealth of design resources, calculators and case studies to aid your design on our website.

Antenova's design laboratories are equipped with the latest antenna design tools and test chambers. We provide antenna design, test and technical integration services to help you complete your design and obtain the required certifications.

If you cannot find the antenna you require in our product range, please contact us to discuss creating a custom antenna to meet your exact requirements.

Share knowledge with RF experts around the world.

ask.antenova is a global forum for designers and engineers working with wireless technology.

[VISIT ASK.ANTENOVA](https://www.ask.antenova.com)

Visit [antenova.com](https://www.antenova.com)

Order antenna samples and evaluation boards, and read our antenna resources

[VISIT ANTENOVA.COM](https://www.antenova.com)

Request a volume quotation for antennas:

sales@antenova.com

Global headquarters

Antenova Ltd, 2nd Floor Titan Court, 3 Bishop Square, Hatfield, AL10 9NA

+44 (0) 1707 927589

X-ON Electronics

Largest Supplier of Electrical and Electronic Components

Click to view similar products for [Antenna Development Tools](#) category:

Click to view products by [Antenova](#) manufacturer:

Other Similar products are found below :

[PCSD.06.A](#) [1002427-02](#) [1004796-01](#) [YC0010AAEVB](#) [1001013-02](#) [1005454-01](#) [1004795-01](#) [1002436-01](#) [ACR1004A-EVB](#) [RAC00024-EVB](#) [RAC00245-EVB](#) [ACR1004GC-EVB](#) [W3012-K](#) [W3006-K](#) [SPD.25A](#) [74889100TB](#) [A10192-U1](#) [DTAD.01.A.50](#) [SR4C033-EVB-1](#) [AEK-LTE-CER](#) [IOT-K](#) [SR4W035-EVB-1](#) [W3010-K](#) [LORA-K](#) [ISM-K](#) [REFLECTOR-EVB-1](#) [ACAG0201-2450-EVB](#) [ACAG0301-15752450-EVB](#) [ACAG0301-1575-EVB](#) [ACAG0301-24505500-EVB](#) [ACAG0301-5500-EVB](#) [ACAG0801-2450-EVB](#) [ACAG1204-433-EVB](#) [ACAG1204-868-EVB](#) [ACAG1204-915-EVB](#) [ACAR0301-SW2-EVB](#) [ACAR3005-C2WB-EVB](#) [ACAR3005-S824-EVB](#) [ACAR3705-S698-EVB](#) [ACAR4008-S698-EVB](#) [ACR0301U-EVB](#) [ACR1504I3-EVB-A](#) [ACR1504I3-EVB-S](#) [ACR2005I4-EVB](#) [ACR4006X-EVB](#) [PRO-EB-450](#) [PRO-EB-453](#) [PRO-EB-472](#) [PRO-EB-476](#) [PRO-EB-550](#)