

DATASHEET

Abdita

SRCW090 • *ceriANT*[®]



Features

- All 2.4GHz applications
- Bluetooth, Wi-Fi, Zigbee, ISM
- Omni-directional with High Efficiency
- SMD mounted Ceramic antenna
- Resistant to de-tuning
- RoHS compliant
- Small clearance area

Contents

1.	Description	2
2.	Applications	2
3.	General data	2
4.	Part number	3
5.	RF characteristics	3
6.	RF performance	4
6.1.	Return loss	4
6.2.	VSWR	4
6.3.	Efficiency	5
6.4.	Antenna patterns	6
7.	Antenna dimensions	7
7.1.	Antenna dimensions	7
7.2.	Antenna footprint	7
8.	Schematic	8
9.	Host PCB footprint	8
10.	Electrical interface	9
10.1.	Transmission line	9
10.2.	Matching circuit	9
11.	Antenna integration guide	10
11.1.	Antenna placement	10
11.2.	Host PCB Clearance	11
12.	Reference board	12
12.1.	Reference board matching circuit	12
13.	Soldering	13
14.	Hazardous material regulation conformance	13
15.	Packaging	13

1. Description

Antenna for all 2.4GHz applications with clearance area of 7x7mm. Suited to small wearable devices. Antenna is simple to integrate into a design and operates on various GND plane sizes. Resistant to de-tuning effects means devices can work well in different environments. Antenna operates with other antenna types nearby (good coexistence). Designs using this antenna are suitable for high volume manufacturing

2. Applications

- Small wearable devices
- Wrist-worn fitness trackers and Headsets
- Medical devices with Bluetooth/Wi-Fi
- Sat-navs / PNDs
- Wireless sensor networks

3. General data



Frequency	2400 – 2500 MHz
Polarization	Linear
Operating Temperature	-40°C to 125°C
Impedance With Matching	50 Ω
Weight	<0.1g
Antenna Type	SMD
Dimensions	1.0 x 0.5 x 0.5 (mm)
Footprint Area	7.0 x 7.0 (mm)

4. Part number

ABDITA
SRCW090



5. RF characteristics

Frequency	2400 – 2500 MHZ
Peak Gain	2.8dBi
Average Gain	-1.9dB
Average Efficiency	60.5%
Maximum Return Loss	-13.0dB
Maximum VSWR	1.6:1

*All data measured on Antenova's evaluation PCB
Part No. SRCW090-EVB-1*

6. RF performance

6.1. Return loss

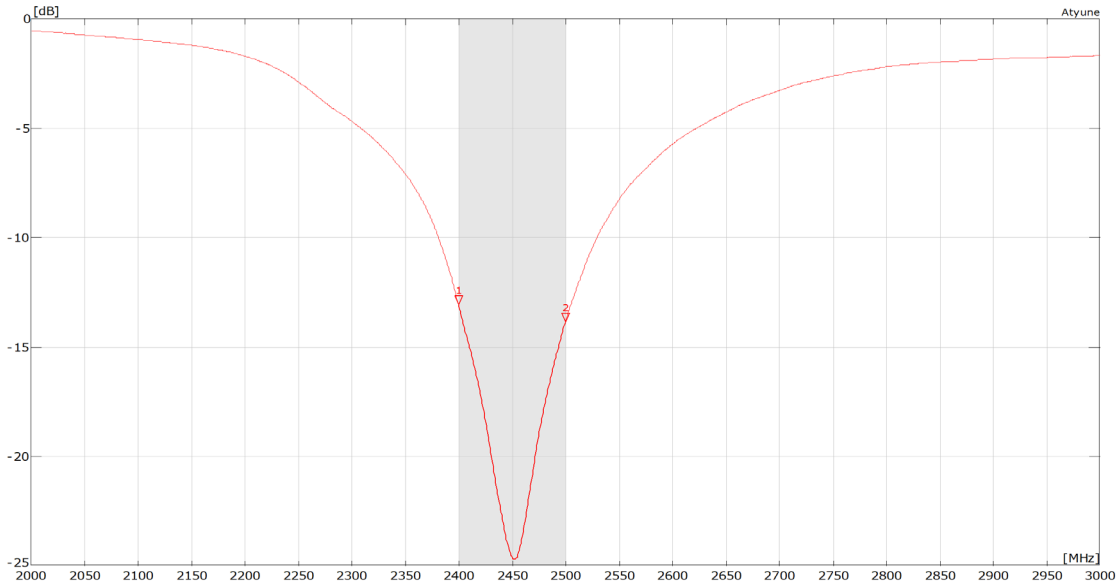

6.2. VSWR

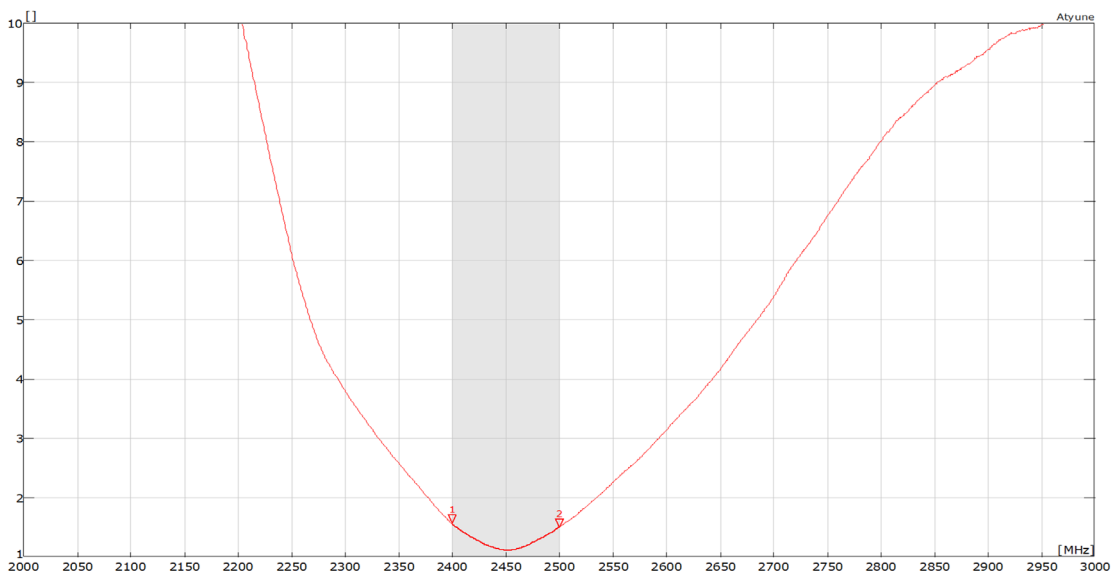

All data measured on Antenna's evaluation PCB
Part No. SRCW090-EVB-1

6.3. Efficiency

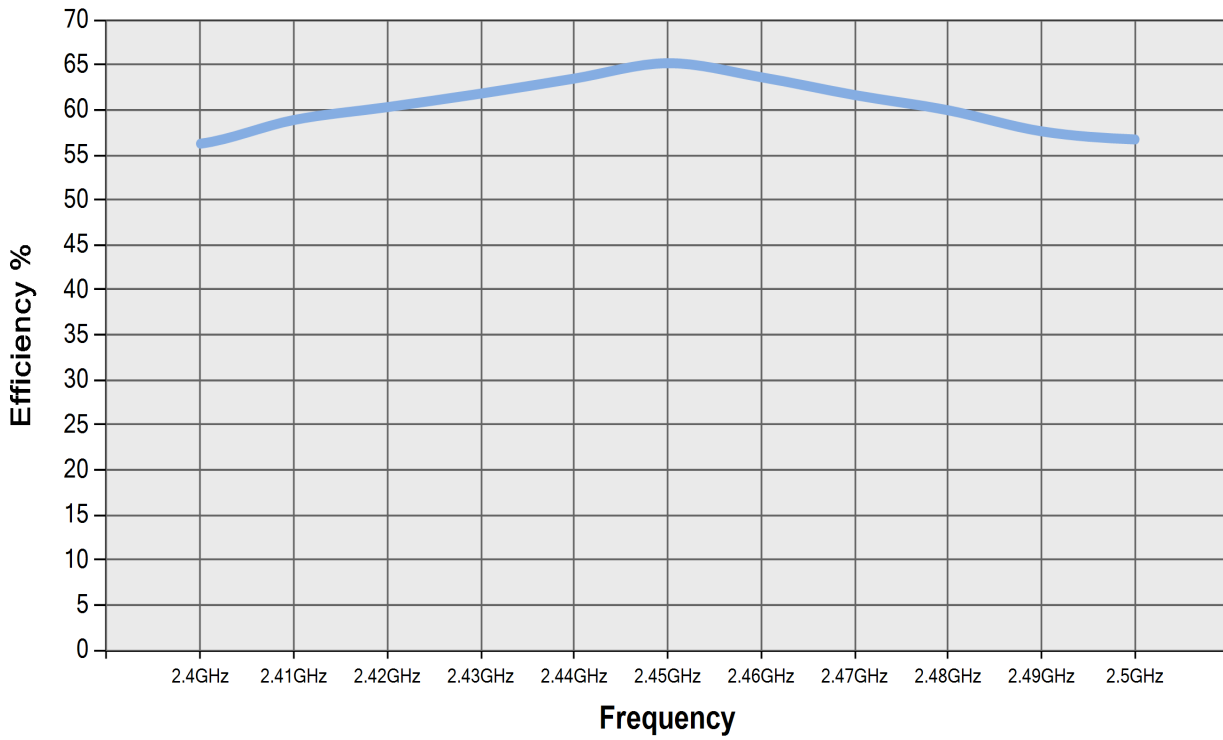

All data measured on Antenova's evaluation PCB
Part No. SRCW090-EVB-1

6.4. Antenna patterns

6.4.1. 2450MHz

3D pattern at 2450MHz

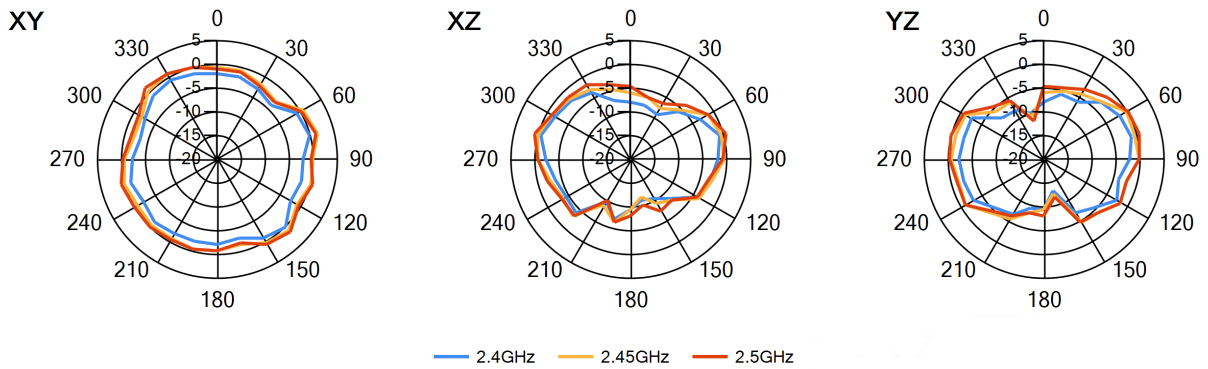
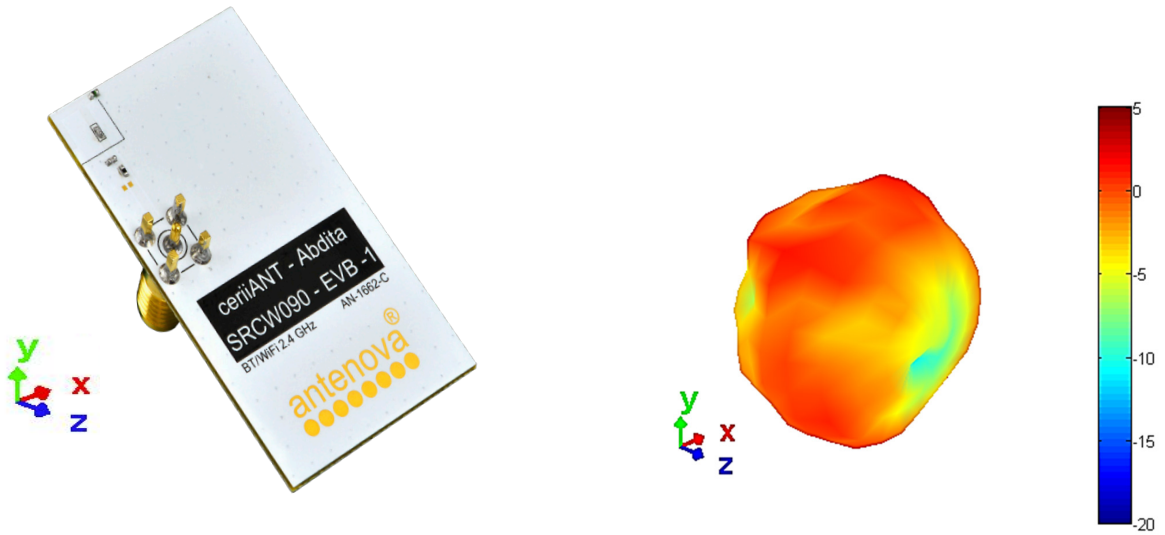

7. Antenna dimensions

7.1. Antenna dimensions

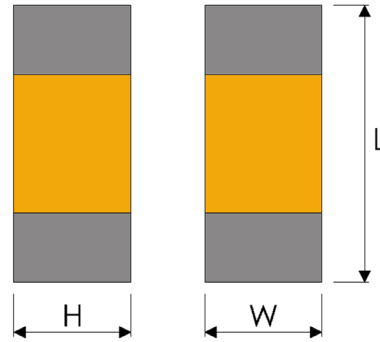

Top view

L	W	H
1.0 ±0.1	0.5 ±0.1	0.5 ±0.1

All dimensions in (mm)

7.2. Antenna footprint

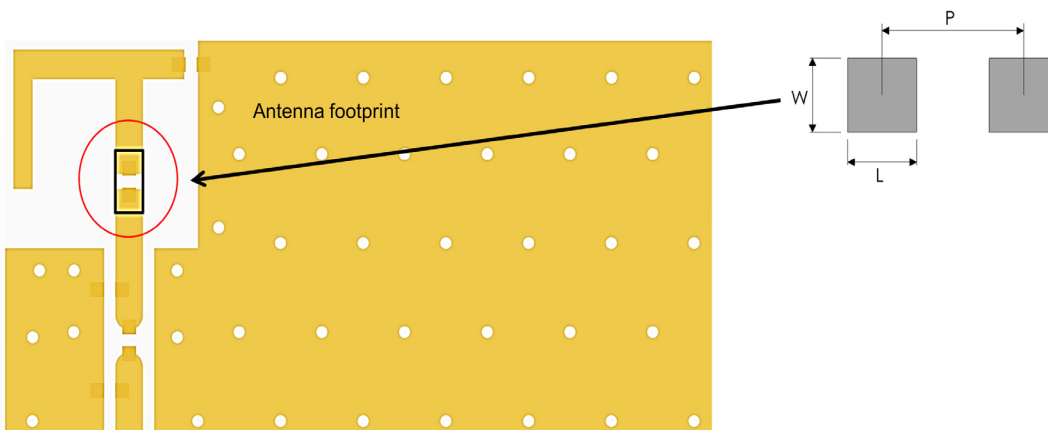

L	W	P
0.5 ±0.1	0.5 ±0.1	0.9 ±0.1

All dimensions in (mm)

8. Schematic

The circuit symbol for the antenna is shown below.

NAME	DESCRIPTION
Abdita (SRCW090)	Antenna
T1	Tuning Component
Pi Network	Antenna matching network

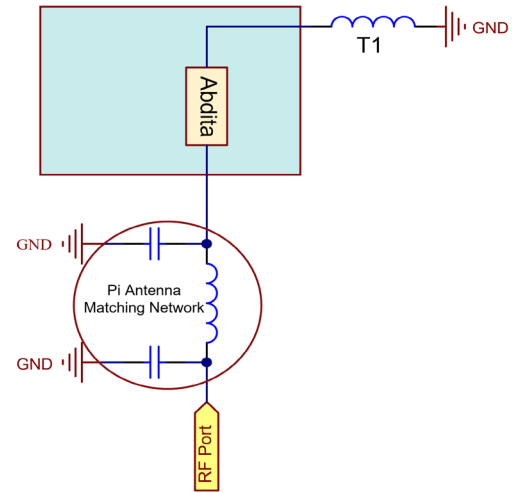

9. Host PCB footprint

The recommended host PCB footprint is below.

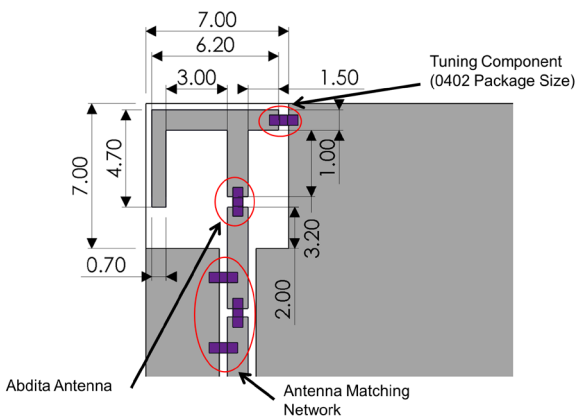

Antenna clearance area = 7mm x 7mm

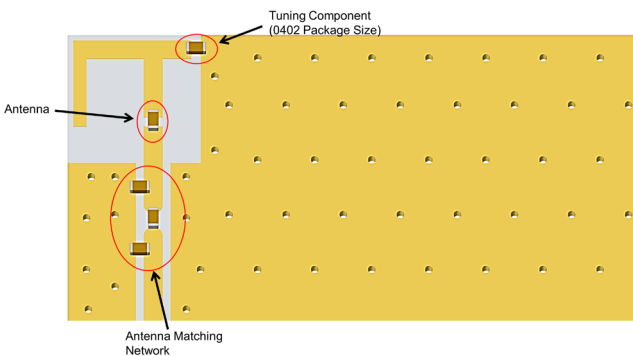

10. Electrical interface

10.1. Transmission line

All transmission lines should be designed to have a characteristic impedance of 50Ω.

- The length of each transmission lines should be kept to a minimum
- All other parts of the RF system like transceivers, power amplifiers, etc, should also be designed to have a 50 Ω impedance

A co-planar transmission line can be designed using an online transmission line calculator tool, such as:

<https://blog.antenova.com/rf-transmission-line-calculator>

The PCB thickness, copper thickness and substrate dielectric constant are entered, then the tool calculates the transmission line width and gaps on either side of the track to give a 50 Ω impedance.

10.2. Matching circuit

The antenna requires a matching circuit that must be optimized for each product. The matching circuit will require up to three components and the following circuit should be designed into the host PCB. Not all components may be required but should be included as a precaution. The matching network should be placed close to the antenna feed to ensure it is optionally effective in tuning the antenna.

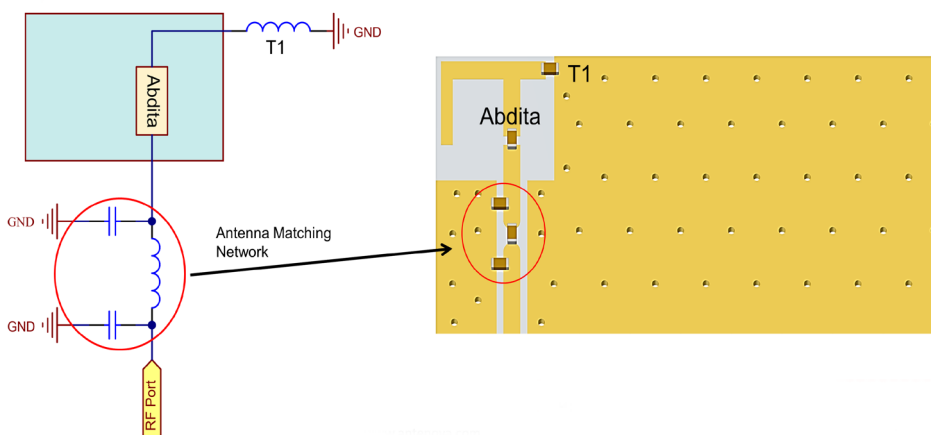

11. Antenna integration guide

We recommend the following during the design phase to maximise antenna performance and minimize noise:

- Minimum 4 layer PCB
- Route signals and power internally where possible
- Flood all layers with ground
- Knit ground on all layers together with plenty of vias

Follow placement guidance carefully. Antenova provide technical support to help you with your design, and also provide design assistance on PTCRB certification. Register for an account on <https://ask.antenova.com/> to access technical support.

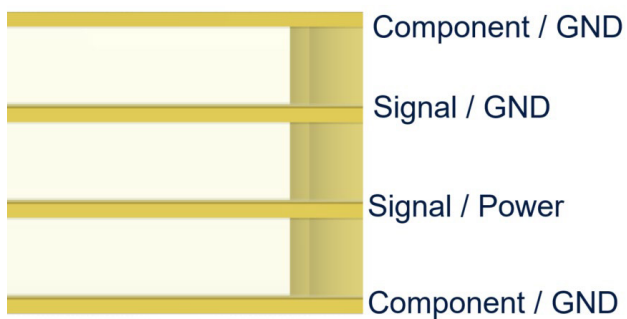

11.1. Antenna placement

The antenna should be placed in the best suited position to effectively radiate. Whichever the PCB size used, it can be left hand side placement.



11.2. Host PCB Clearance

The host PCB must be designed using the PCB footprint shown with the correct clearances. An example of the PCB layout shows the antenna footprint. Please note this clearance area is critical to the performance of the antenna and must be applied through all layers of the PCB.

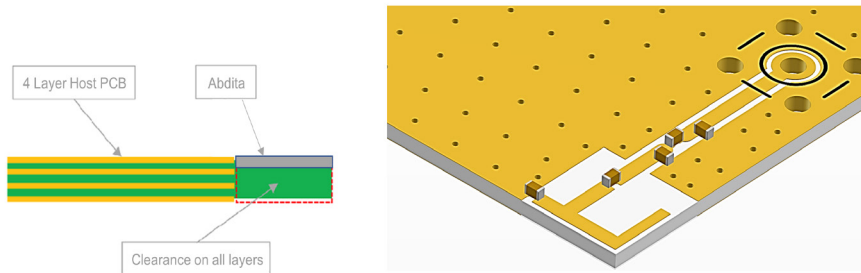

All dimensions in (mm)

12. Reference board

A reference board is used for evaluating the antenna SRCW090 and it includes a SMA female connector. (part number SRCW090-EVB-1)

To order a reference board please see antenna.com



12.1. Reference board matching circuit

DESIGNATOR	TYPE	VALUE	Description
Abdita	Antenna	Antenova	2400 – 2500 MHz
T1	Inductor	2.7nH	Murata LQG15HS series
C1	Not Fitted		
C2	Capacitor	1.0pF	Murata GJM15 series
L1	Resistor	0ohm	Non-Spec

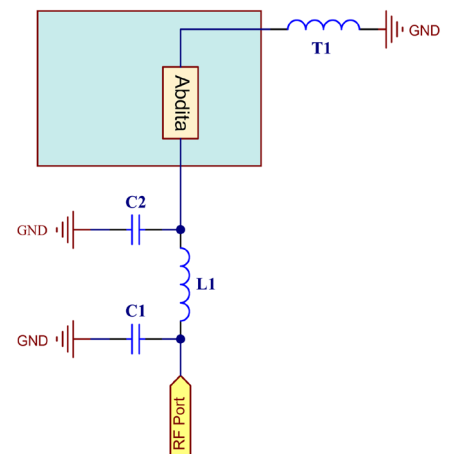

13. Soldering

This antenna is suitable for lead free soldering. The reflow profile should be adjusted to suit the device, oven and solder paste, while observing the following conditions:

- For leaded soldering, the maximum temperature should not exceed 240 °C.
- For lead free soldering, a maximum temperature of 255 °C for no more than 20 seconds is permitted.
- The antenna should not be exposed to temperatures exceeding 120 °C more than 3 times during the soldering process.

14. Hazardous material regulation conformance

The antenna has been tested to conform to RoHS and REACH requirements. A certificate of conformance is available from Antenova's website.

15. Packaging

15.1. Optimal storage conditions

TEMPERATURE	-10°C to 40°C
HUMIDITY	Less than 75% RH
SHELF LIFE	24 Months
STORAGE PLACE	Away from corrosive gas and direct sunlight
PACKAGING	Reels should be stored in unopened sealed manufacturer's plastic packaging.
MSL LEVEL	1

Note: Storage of open reels of antennas is not recommended due to possible oxidization of pads on antennas. If short term storage is necessary, then it is highly recommended that the bag containing the antenna reel is re-sealed and stored in conditions as described in the table above.

The shelf life of the antenna is 2 years provided the factory seal on the package has not been broken.

15.2. Tape characteristics

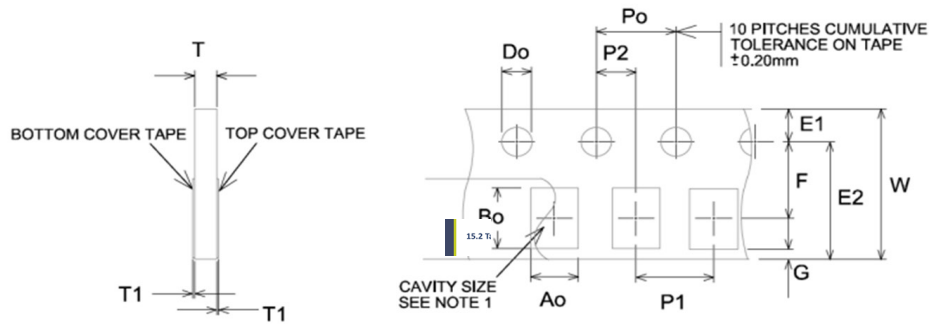

All dimensions in mm

Do	E1	E2	F	G	Po
1.50±0.1	1.75±0.1	6.25±0.1	3.50±0.05	0.75 min	4.00±0.1

P1	P2	T	T1	W	Ao & Bo
4.00±0.1	2.00±0.05	1.10 max	0.1 max	8.00±0.3	See note 1

Notes:

The cavity defined by Ao, Bo, and T shall be configured to provide sufficient clearance surrounding the antenna so that:

- a) The component does not protrude beyond either surface of the carrier tape.
- b) The component can be removed from the cavity in a vertical direction without mechanical restriction after the top cover tape has been removed.
- c) Rotation of the component is limited to 20° maximum.
- d) Lateral movement of the component is restricted to 0.5mm maximum.

15.3. Reel dimensions

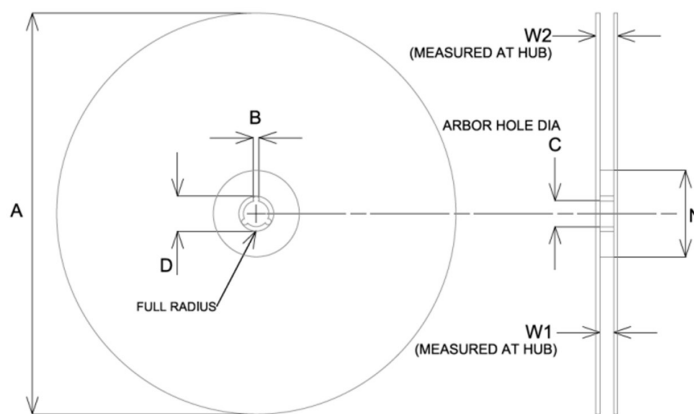

All dimensions in mm

A	B	C	D	W1	W2
178+/-1mm	2.2+/-0.5mm	13.0±0.5	20.2(min)	9+/-0.5mm	11.4+/-0.5mm

Quantity	Leading Space	Trailing Space
10000 pcs /reel	390+/-1mm	390+/-1mm

15.4. Box dimensions

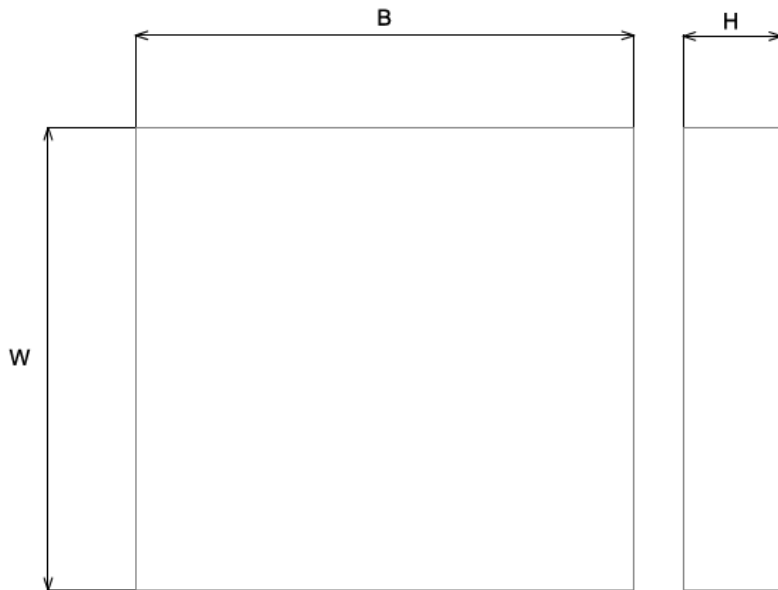

WIDTH (W)	BREADTH (B)	HEIGHT (H)
180mm	185mm	40mm

15.5. Bag properties

Reels are supplied in protective plastic packaging.

15.6. Reel label information

Antenova Limited
 www.antenova.com
 Description: Abdita
 Part Number: SRCW090 
 Qty: 10,000 pcs 
 Date Code: YYWW 



Quality statements

Antenova's products conform to REACH and RoHS legislation. For our statements regarding these and other quality standards, please see antenova.com.



Antenova reserves all rights to the contents of this document. Antenova gives no warranties based solely on the accuracy or completeness of the contents of this document and reserves the right to make changes to the specifications of the products described herein at any time and without notice.

Datasheet version

1.01 release JULY 15 2023

Antenna design, integration and test resources

Product designers – the details contained in this datasheet will help you to complete your embedded antenna design. Please follow our technical advice carefully to obtain optimum antenna performance.

We aim to support our customers to create high performance wireless products. You will find a wealth of design resources, calculators and case studies to aid your design on our website.

Antenova's design laboratories are equipped with the latest antenna design tools and test chambers. We provide antenna design, test and technical integration services to help you complete your design and obtain the required certifications.

If you cannot find the antenna you require in our product range, please contact us to discuss creating a custom antenna to meet your exact requirements.

Share knowledge with RF experts around the world.

ask.antenova is a global forum for designers and engineers working with wireless technology.

[VISIT ASK.ANTENOVA](https://www.ask.antenova.com)

Visit [antenova.com](https://www.antenova.com)

Order antenna samples and evaluation boards, and read our antenna resources

[VISIT ANTENOVA.COM](https://www.antenova.com)

Request a volume quotation for antennas:

sales@antenova.com

Global headquarters

Antenova Ltd, 2nd Floor Titan Court, 3 Bishop Square, Hatfield, AL10 9NA

+44 (0) 1707 927589

X-ON Electronics

Largest Supplier of Electrical and Electronic Components

Click to view similar products for [Antenna Development Tools](#) category:

Click to view products by [Antenova](#) manufacturer:

Other Similar products are found below :

[PCSD.06.A](#) [1002427-02](#) [1004796-01](#) [YC0010AAEVB](#) [1001013-02](#) [1005454-01](#) [1004795-01](#) [1002436-01](#) [ACR1004A-EVB](#) [RAC00024-EVB](#) [RAC00245-EVB](#) [ACR1004GC-EVB](#) [W3012-K](#) [W3006-K](#) [SPD.25A](#) [74889100TB](#) [A10192-U1](#) [DTAD.01.A.50](#) [SR4C033-EVB-1](#) [AEK-LTE-CER](#) [IOT-K](#) [SR4W035-EVB-1](#) [W3010-K](#) [LORA-K](#) [ISM-K](#) [REFLECTOR-EVB-1](#) [ACAG0201-2450-EVB](#) [ACAG0301-15752450-EVB](#) [ACAG0301-1575-EVB](#) [ACAG0301-24505500-EVB](#) [ACAG0301-5500-EVB](#) [ACAG0801-2450-EVB](#) [ACAG1204-433-EVB](#) [ACAG1204-868-EVB](#) [ACAG1204-915-EVB](#) [ACAR0301-SW2-EVB](#) [ACAR3005-C2WB-EVB](#) [ACAR3005-S824-EVB](#) [ACAR3705-S698-EVB](#) [ACAR4008-S698-EVB](#) [ACR0301U-EVB](#) [ACR1504I3-EVB-A](#) [ACR1504I3-EVB-S](#) [ACR2005I4-EVB](#) [ACR4006X-EVB](#) [PRO-EB-450](#) [PRO-EB-453](#) [PRO-EB-472](#) [PRO-EB-476](#) [PRO-EB-550](#)