



SAW Band Pass Filter

For LTE B8 Rx

925-960MHz

1.1x0.9mm Size

SAFI1109B08BPF1101

[Shapes and Dimensions]

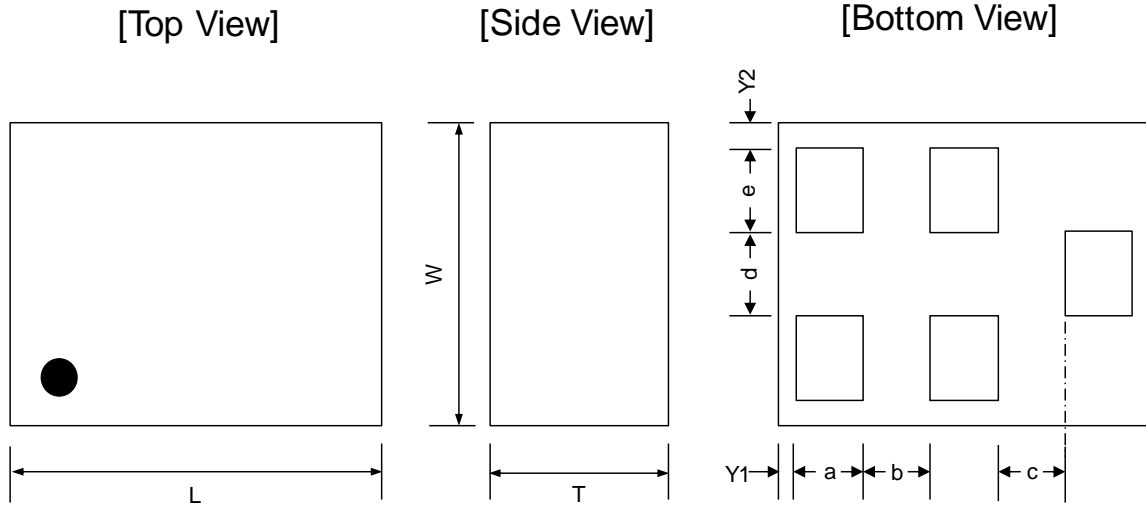

Dimensions (mm)

L	W	T	a	b	c	d	e	Y1	Y2
1.1	0.9	0.6	0.2	0.2	0.2	0.25	0.25	0.05	0.075
+/-0.10	+/-0.10	+/-0.05	+/-0.05	+/-0.05	+/-0.05	+/-0.05	+/-0.05	+/-0.05	+/-0.05

[Terminal Functions]

[Top View]

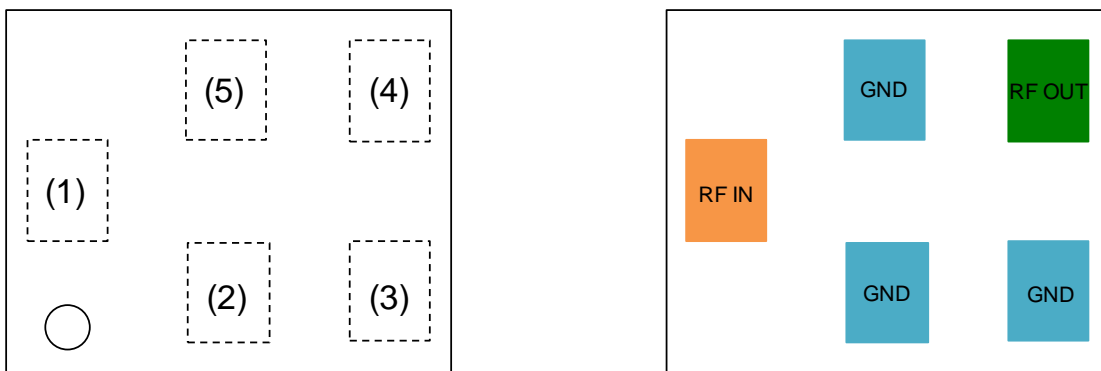

(1)	RF IN	(2)	GND	(3)	GND	(4)	RF OUT	(5)	GND
-----	-------	-----	-----	-----	-----	-----	--------	-----	-----

[Recommended Land Pattern]

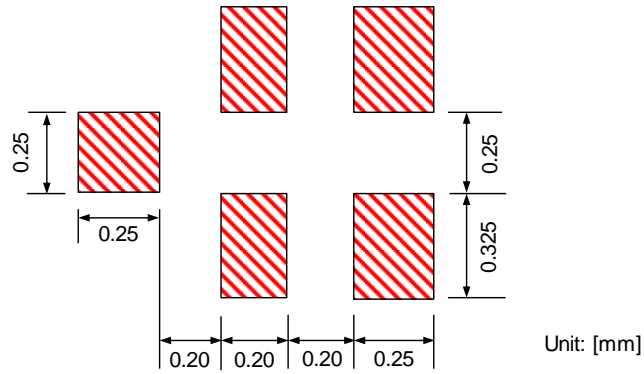

[Measurement Circuit]

Top View

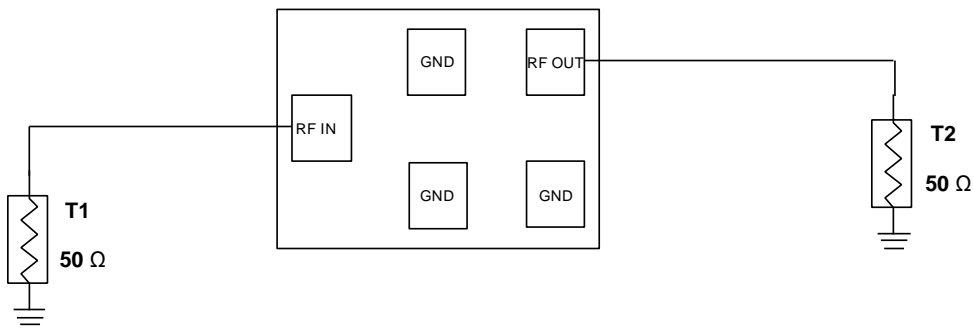

[Electrical Characteristics] (Measurement)

Parameter	Frequency (MHz)	Target Spec		
		Min.	Typ.	Max.
Insertion Loss (dB)	925 to 960	-	1.9	2.5
Return Loss (dB)	925 to 960	9	11	-
Ripple Deviation (dB)	925 to 960	-	1.1	1.8
Attenuation (dB)	45	40	60	-
	835 to 870	40	44	-
	880 to 915	35	40	-
	1710 to 1785	40	47	-
	1805 to 1920	40	45	-
	1920 to 1980	40	44	-
	2400 to 2483	35	39	-
	2775 to 2880	30	36	-
	3700 to 4800	25	31	-
	5150 to 5850	20	30	-
Max Input Power (dBm)		15		
Ambient Temperature (°C)		25		
Operating Temperature Range (°C)		-35	-	85
Storage Temperature Range (°C)		-40	-	85

[Frequency Characteristics]

Insertion Loss

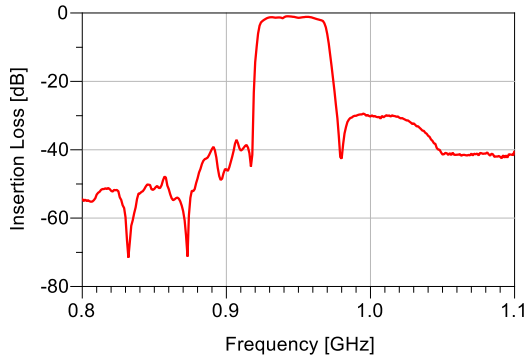

Input Return Loss

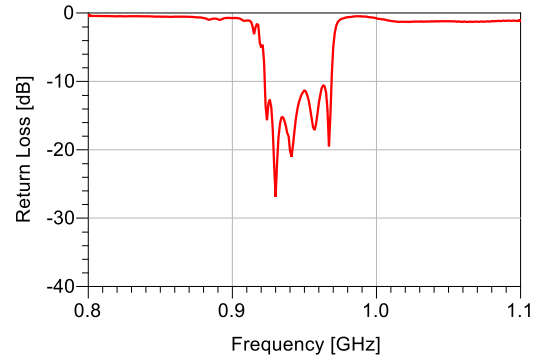

Attenuation

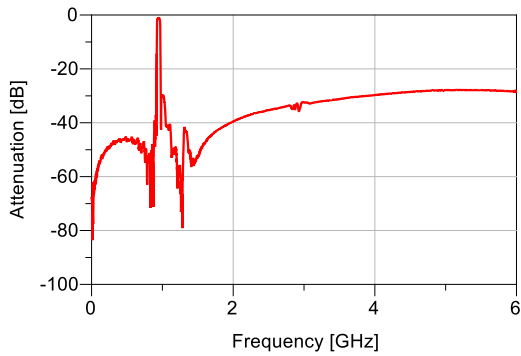

Output Return Loss

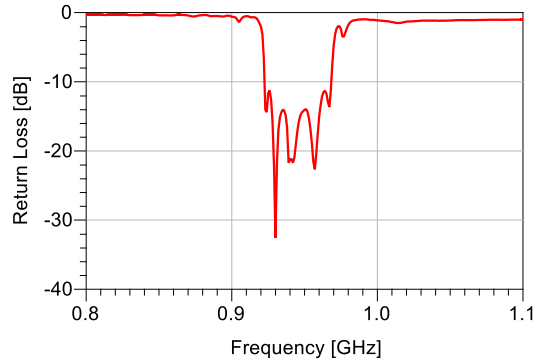

X-ON Electronics

Largest Supplier of Electrical and Electronic Components

Click to view similar products for [Signal Conditioning](#) category:

Click to view products by [ANUKI](#) manufacturer:

Other Similar products are found below :

[MAPDCC0004](#) [PD0409J5050S2HF](#) [880157](#) [HHS-109-PIN](#) [DC1417J5005AHF](#) [DC4859J5005AHF](#) [AFS14A30-2185.00-T3](#) [AFS14A35-1591.50-T3](#) [DS-323-PIN](#) [DSS-313-PIN](#) [B39321R801H210](#) [B39321R821H210](#) [B39921B4317P810](#) [1A0220-3](#) [2089-6207-00](#) [JP510S](#) [LFB212G45SG8C341](#) [LFB322G45SN1A504](#) [LFL182G45TC3B746](#) [SF2159E](#) [30057](#) [1P510S](#) [CER0813B](#) [3A325](#) [40287](#) [41180](#) [ATB3225-75032NCT](#) [B69842N5807A150](#) [BD0810N50100AHF](#) [BD2326L50200AHF](#) [BD2425J50200AHF](#) [HMC189AMS8TR](#) [C5060J5003AHF](#) [JHS-114-PIN](#) [JP503AS](#) [DC0710J5005AHF](#) [DC2327J5005AHF](#) [DC3338J5005AHF](#) [43020](#) [LFB2H2G60BB1C106](#) [LFL15869MTC1B787](#) [X3C19F1-20S](#) [XC3500P-20S](#) [10013-20](#) [SF2081E](#) [SF2194E](#) [SF2238E](#) [CDBLB455KCAX39-B0](#) [RF1353C](#) [PD0922J5050D2HF](#)