



**SAW Band Pass Filter
For GPS/GLONASS/BEIDOU2**

1.1x0.9mm Size

SAFI1109GPSBPF1101

[Shapes and Dimensions]

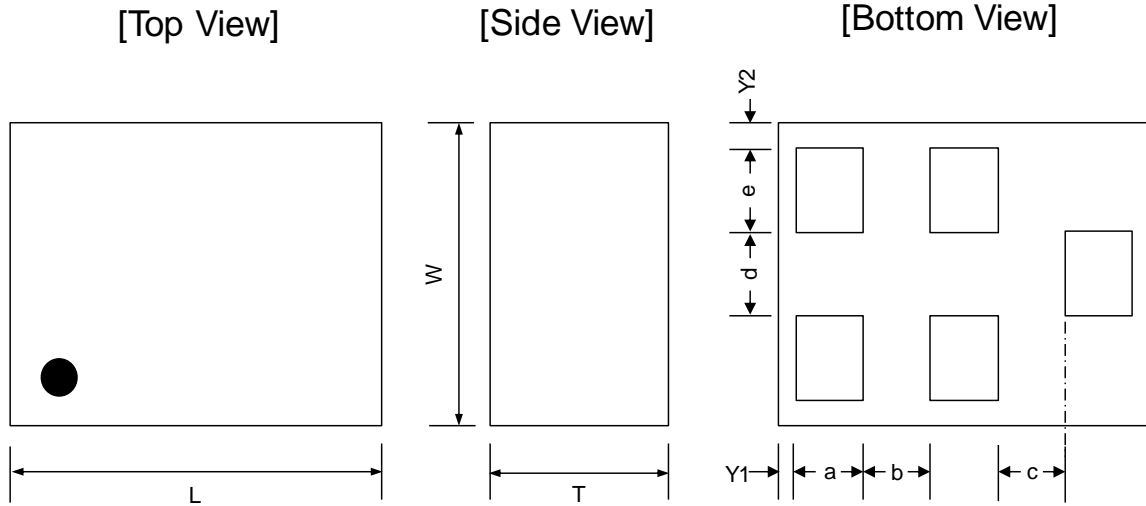

Dimensions (mm)

L	W	T	a	b	c	d	e	Y1	Y2
1.1	0.9	0.6	0.2	0.2	0.2	0.25	0.25	0.05	0.075
+/-0.10	+/-0.10	+/-0.05	+/-0.05	+/-0.05	+/-0.05	+/-0.05	+/-0.05	+/-0.05	+/-0.05

[Terminal Functions]

[Top View]

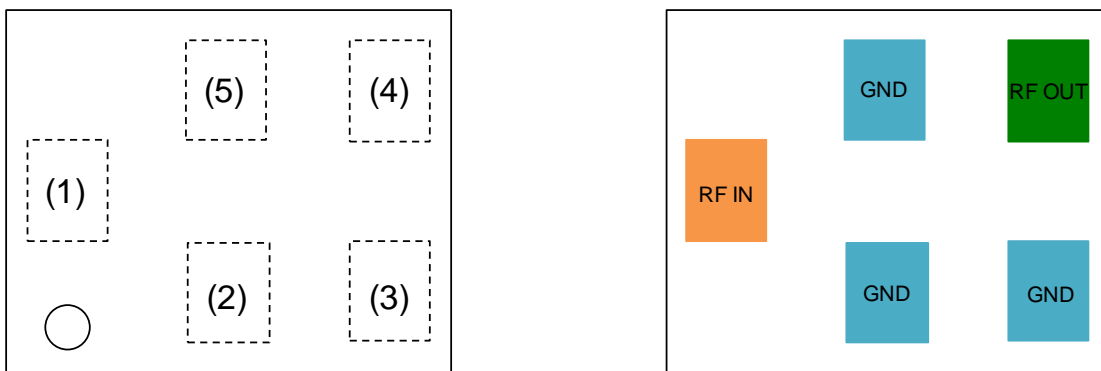

(1)	RF IN	(2)	GND	(3)	GND	(4)	RF OUT	(5)	GND
-----	-------	-----	-----	-----	-----	-----	--------	-----	-----

[Recommended Land Pattern]

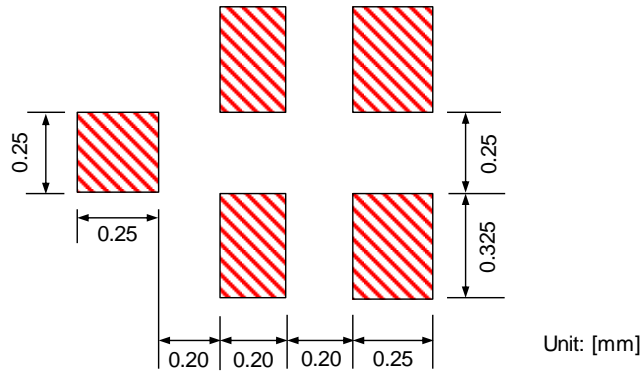

[Measurement Circuit]

Top View

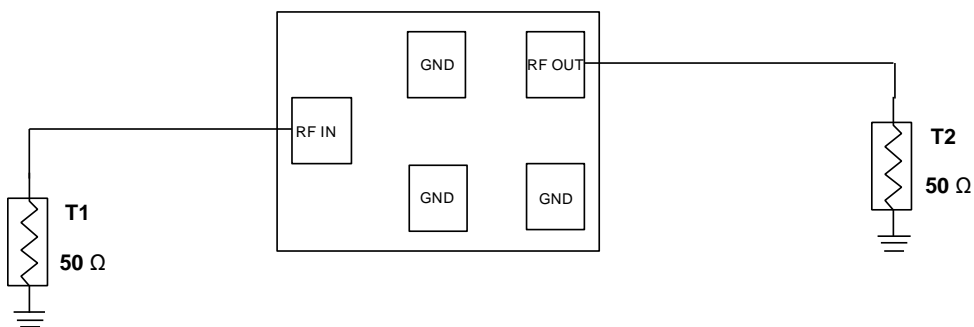

[Electrical Characteristics] (Measurement)

Parameter	Frequency (MHz)	Target Spec		
		Min.	Typ.	Max.
Insertion Loss (dB)	1574.42 to 1576.42	-	1	1.5
	1597.55 to 1605.89	-	1.6	2.1
	1559.05 to 1563.14	-	1.6	2.1
Input Return Loss (dB)	1574.42 to 1576.42	9	14	-
	1597.55 to 1605.89	10	15	-
	1559.05 to 1563.14	10	14	-
Output Return Loss (dB)	1574.42 to 1576.42	9	14	-
	1597.55 to 1605.89	10	15	-
	1559.05 to 1563.14	10	14	-
Ripple Deviation (dB)	1574.42 to 1576.42	-	0.1	0.8
	1597.55 to 1605.89	-	0.4	1.3
	1559.05 to 1563.14	-	0.2	1.3
Group Delay Ripple (ns)	1574.42 to 1576.42	-	1	6
	1597.55 to 1605.89	-	4	12
	1559.05 to 1563.14	-	5	13
Attenuation (dB)	699 to 716	31	34	-
	777 to 787	31	34	-
	814 to 849	30	33	-
	880 to 915	30	33	-
	1427.9 to 1446.9	34	37	-
	1447.9 to 1462.9	35	38	-
	1710 to 1785	32	35	-
	1850 to 1915	32	35	-
	1920 to 1980	32	35	-
	2400 to 2500	33	36	-
2500 to 2570	33	36	-	
Max Input Power (dBm)		15		
Ambient Temperature (°C)		25		
Operating Temperature Range (°C)		-40	-	85
Storage Temperature Range (°C)		-40	-	85

[Frequency Characteristics]

Insertion Loss

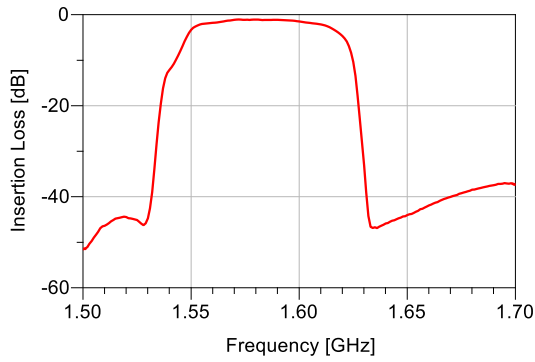

Input Return Loss

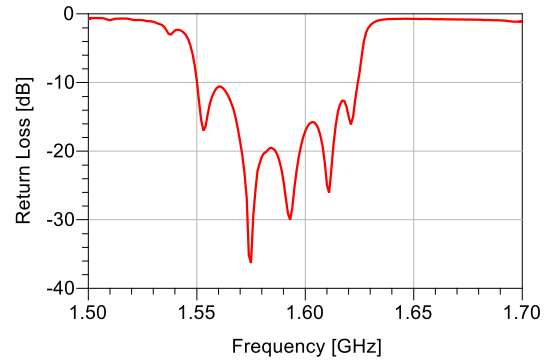

Attenuation

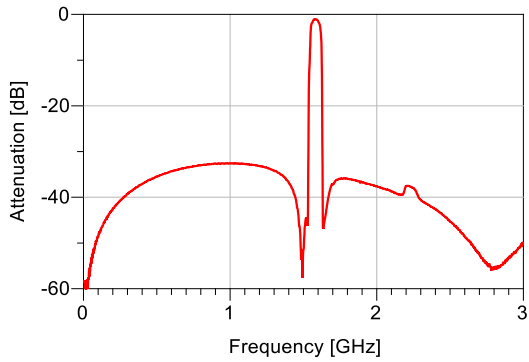

Output Return Loss

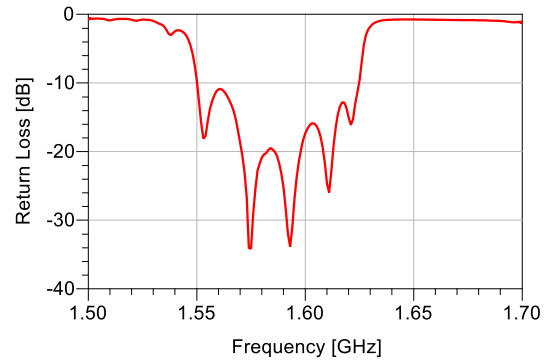

Group Delay

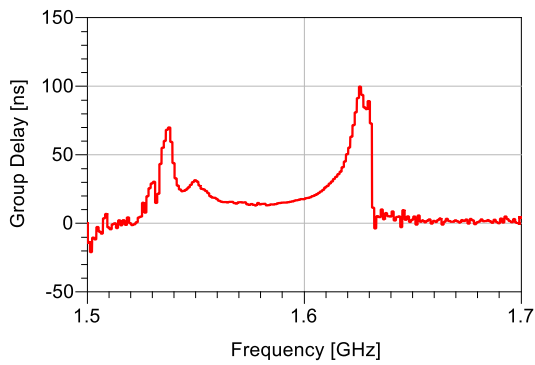

X-ON Electronics

Largest Supplier of Electrical and Electronic Components

Click to view similar products for [Signal Conditioning](#) category:

Click to view products by [ANUKI](#) manufacturer:

Other Similar products are found below :

[MAPDCC0004](#) [PD0409J5050S2HF](#) [880157](#) [HHS-109-PIN](#) [DC1417J5005AHF](#) [DC4859J5005AHF](#) [AFS14A30-2185.00-T3](#) [AFS14A35-1591.50-T3](#) [DS-323-PIN](#) [DSS-313-PIN](#) [B39321R801H210](#) [B39321R821H210](#) [B39921B4317P810](#) [1A0220-3](#) [2089-6207-00](#) [JP510S](#) [LFB212G45SG8C341](#) [LFB322G45SN1A504](#) [LFL182G45TC3B746](#) [SF2159E](#) [30057](#) [1P510S](#) [CER0813B](#) [3A325](#) [40287](#) [41180](#) [ATB3225-75032NCT](#) [B69842N5807A150](#) [BD0810N50100AHF](#) [BD2326L50200AHF](#) [BD2425J50200AHF](#) [HMC189AMS8TR](#) [C5060J5003AHF](#) [JHS-114-PIN](#) [JP503AS](#) [DC0710J5005AHF](#) [DC2327J5005AHF](#) [DC3338J5005AHF](#) [43020](#) [LFB2H2G60BB1C106](#) [LFL15869MTC1B787](#) [X3C19F1-20S](#) [XC3500P-20S](#) [10013-20](#) [SF2081E](#) [SF2194E](#) [SF2238E](#) [CDBLB455KCAX39-B0](#) [RF1353C](#) [PD0922J5050D2HF](#)