



**高速光耦**  
**High Speed Photo**  
**Coupler**

**6N137M**

**Product Data Sheet**

**AOTE DCC**  
**RELEASE**

**台湾奥特半导体科技有限公司**

TAIWAN AOTE SEMICONDUCTOR TECHNOLOGY CO.,LTD

[www.aotesemi.com](http://www.aotesemi.com)

## 概述 Description

6N137M 光耦合器由一个 850nm 的 AlGaAs LED 组成，其光学耦合到一个非常高速的集成光电探测器逻辑门，可快速输出。

The 6N137M optocoupler consists of a 850 nm AlGaAs LED, optically coupled to a very high speed integrated photo-detector logic gate with a strobeable output.

## 特性 Features

- 高比特率：10MBit/s  
High bit rate：10MBit/s
- 输入-输出隔离电压 ( $V_{ISO}=5000\text{ Vrms}$ )  
High isolation voltage between input and output ( $V_{ISO}=5000\text{ Vrms}$ )
- 工作温度范围：-40°C ~ 85°C  
Fan-out of 8 over -40°C to +85°C
- 逻辑门输出  
Logic gate output
- 频闪输出  
Strobeable output
- 符合加强绝缘标准  
Meet reinforced insulation standards
- 符合安规标准：UL 1577，VDE DIN EN60747-5-5 (VDE 0884-5)，CQC11-471543-2022  
Meet Safety standard: UL 1577, VDE DIN EN60747-5-5 (VDE 0884-5)，CQC11-471543-2022

## 应用 Applications

- 接地回路消除  
Ground loop elimination
- LSTTL 转 TTL, LSTTL 或 5V CMOS  
LSTTL to TTL, LSTTL or 5-volt CMOS
- 线路接收器，数据传输  
Line receiver, data transmission
- 开关电源  
Switching power supplies
- 计算机外围接口  
Computer-peripheral interface

## 真值表 Truth table

LED	ENABLE	OUT
ON	H	L
OFF	H	H
ON	L	H
OFF	L	H
ON	NC	L
OFF	NC	H

## 封装和原理图 Package and Schematic Diagram

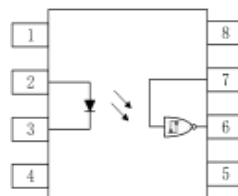



Pin Configuration

1. NC	8. VCC
2. Anode	7. VE
3. Cathode	6. VO
4. NC	5. GND

注：在引脚 5 和 8 之间必须连接一个 0.1uF 的旁路电容器。

Note: 0.1uF bypass capacitor must be connected between pins 5 and 8.

## 印字信息 Marking Information

- 印字中 “” 为奥特品牌 LOGO  
 “” denotes LOGO
- 印字中 “Y” 代表年份: A(2018), B(2019), C(2020).....  
 “Y” denotes YEAR : A(2018), B(2019), C(2020).....
- 印字中 “WW” 代表周号  
 “WW” denotes Week' s number
- 印字中 “N” 代表星期几  
 “N” denotes the day of the week
- 印字中的 “H” 代表无卤  
 “H” denotes Halogen-free

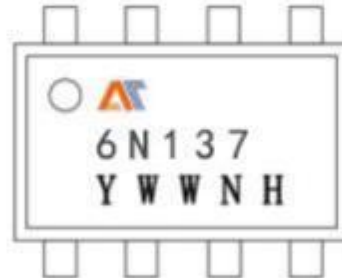

**绝缘和安规信息 Insulation and Safety related specifications**

项目 Item	符号 Symbol	数值 Value	单位 Unit	备注 Remark
爬电距离 Creepage Distance	L	>7.6	mm	从输入端到输出端，沿本体最短距离路径 Measured from input terminals to output terminals, shortest distance path along body
电气间隙 Clearance Distance	L	>7.6	mm	从输入端到输出端，通过空气的最短距离 Measured from input terminals to output terminals, shortest distance through air
绝缘距离 Insulation Thickness	DTI	> 0.4	mm	发射器和探测器之间的绝缘厚度 Insulation thickness between emitter and detector
峰值隔离电压 Peak Isolation Voltage	$V_{IORM}$	1500	$V_{peak}$	DIN/EN/IEC EN60747-5-5
瞬态隔离电压 Transient isolation voltage	$V_{IOTM}$	7000	$V_{peak}$	DIN/EN/IEC EN60747-5-5
隔离电压 Isolation Voltage	$V_{iso}$	>5000	$V_{rms}$	For 1 min

**极限参数 Absolute Maximum Ratings (TA =25°C)**

参数 Parameter		符号 Symbol	额定值 Rating	单位 Unit
发射端 Input	正向输入电流 (平均) DC/Average Forward Input Current	$I_F$	20	mA
	使能输入电压不超过 $V_{CC}$ 500mV Enable Input Voltage Not to Exceed $V_{CC}$ by more than 500mV	$V_E$	5.5	V
	反向输入电压 Reverse Input Voltage	$V_R$	5.0	V
	功耗 Power Dissipation	$P_t$	100	mW
接收端 output	电源电压 Supply Voltage	$V_{CC}$ (1 minute max)	7.0	V
	输出电流 Output Current	$I_o$	50	mA
	输出电压 Output Voltage	$V_o$	7.0	V
	输出功率 Collector Output	$P_o$	85	mW
工作温度 Operating Temperature		$T_{opr}$	-40~+85	°C
存储温度 Storage Temperature		$T_{stg}$	-55~+125	°C
焊接温度 Lead Solder Temperature (for wave soldering only)		$T_{sol}$	260 for 10 sec	°C

**推荐操作条件 Recommended Operating Conditions**

参数 Parameter	符号 Symbol	最小值 Min	最大值 Max	单位 Unit
低电平输入电流 Low Level Input Current	$I_{L}$	0	250	$\mu$ A
高电平输入电流 High Level Input Current	$I_{H}$	6.3	15	mA
电源电压 Supply Voltage	$V_{CC}$	2.7	5.5	V
低电平使能电压 Low Level Enable Voltage	$V_{EL}$	0	0.8	V
高电平使能电压 Low Level Enable Voltage	$V_{EH}$	2.0	$V_{CC}$	V
工作温度 Operating Temperature	$T_A$	-40	+85	$^{\circ}$ C
输出上拉电阻 Output Pull-up Resistor	$R_L$	330	4k	$\Omega$

**产品特性参数 Electro-optical Characteristics (T<sub>A</sub> = 25°C)**

	参数 Parameter	符号 Symbol	条件 Condition	最小 Min.	典型 Typ.	最大 Max.	单位 Unit
发射端 Input	正向电压 Input Forward Voltage	V <sub>F</sub>	I <sub>F</sub> = 10mA	-	1.33	1.75	V
	反向击穿电压 Input Reverse Breakdown Voltage	B <sub>VR</sub>	I <sub>R</sub> = 10μA	5	20	45	V
	输入电容 Input Capacitance	C <sub>IN</sub>	V = 0, f = 1MHz	-	70	-	pF
接收端 Output	正向电压的温度系数 Input Diode Temperature Coefficient	ΔV <sub>F</sub> /ΔT <sub>A</sub>	I <sub>F</sub> = 10mA	-	-1.4	-	mV/°C
	高电平电源电流 High Level Supply Current	I <sub>CH</sub>	V <sub>CC</sub> = 5.5V, I <sub>F</sub> = 0mA, V <sub>E</sub> = 0.5V	-	6.5	10	mA
	低电平电源电流 Low Level Supply Current	I <sub>CL</sub>	V <sub>CC</sub> = 5.5V, I <sub>F</sub> = 10mA	-	9	13	mA
传输特性 Transfer Characteristics	低电平使能电流 Low Level Enable Current	I <sub>EL</sub>	V <sub>CC</sub> = 5.5V, V <sub>E</sub> = 0.5V	-	-0.8	-1.6	mA
	高电平使能电流 High Level Enable Current	I <sub>EH</sub>	V <sub>CC</sub> = 5.5V, V <sub>E</sub> = 2.0V	-	-0.6	-1.6	mA
	高电平使能电压 High Level Enable Voltage	V <sub>EH</sub>	V <sub>CC</sub> = 5.5V, I <sub>F</sub> = 10mA	2.0	-	-	V
	低电平使能电压 Low Level Enable Voltage	V <sub>EL</sub>	V <sub>CC</sub> = 5.5V, I <sub>F</sub> = 10mA	-	-	0.8	V
	高电平输出电流 High Level Output Current	I <sub>OH</sub>	V <sub>CC</sub> = 5.5V, V <sub>O</sub> = 5.5V I <sub>F</sub> = 250μA, V <sub>E</sub> = 2V	-	-	100	μA
	低电平输出电压 Low Level Output Current	V <sub>OL</sub>	V <sub>CC</sub> = 5.5V, I <sub>F</sub> = 5mA I <sub>OL</sub> = 13mA, V <sub>E</sub> = 2V	-	0.35	0.6	V
	输入阈值电流 Input Threshold Current	I <sub>T</sub>	V <sub>CC</sub> = 5.5V, V <sub>O</sub> < 0.6V I <sub>OL</sub> = 13mA, V <sub>E</sub> = 2V	-	3	5	mA
隔离电阻 Isolation Resistance	R <sub>I-O</sub>	V <sub>I-O</sub> = 500V	-	10 <sup>12</sup>	-	Ω	
隔离电容 Isolation Capacitance	C <sub>I-O</sub>	f = 1MHz	-	0.6	-	pF	

**开关特性 Switching Specification**

参数 Parameter	符号 Symbol	条件 Condition	最小 Min.	典型 Typ.	最大 Max.	单位 Unit
输出高电平传播延迟 Propagation Delay Time to Output HIGH Level	$T_{PLH}$	$I_f = 7.5mA,$ $V_{CC} = 5V,$ $R_L = 350\Omega,$ $C_L = 15pF$	20	41	100	ns
输出低电平传播延迟 Propagation Delay Time to Output LOW Level	$T_{PHL}$		25	50	100	ns
脉宽失真 ( $ T_{PHL}-T_{PLH} $ ) Pulse Width Distortion	PWD		-	5	35	ns
输出上升时间(10% – 90%) Output Rise Time (10–90%)	tr		-	30	-	ns
输出下降时间(90% - 10%) Output Rise Time (90–10%)	tf		-	10	-	ns
输出高电平使能传播延迟 Enable Propagation Delay Time to Output HIGH Level	$t_{ELH}$	$I_f = 7.5mA,$ $V_{EH} = 3.5V,$ $R_L = 350\Omega,$ $C_L = 15pF$	-	15	-	ns
输出低电平使能传播延迟 Enable Propagation Delay Time to Output LOW Level	$t_{EHL}$		-	40	-	ns
输出高电平共模瞬态抑制 Common Mode Transient Immunity (at Output HIGH Level)	$ CM_H $	$T_A = 25^\circ C$ $V_{CC} = 5V, I_f = 0mA$ $ V_{CM}  = 50V(\text{Peak})$ $V_{O(\text{MIN})} = 2.0V, R_L = 350\Omega$	5000	10000	-	V/ $\mu s$
输出低电平共模瞬态抑制 Common Mode Transient Immunity (at Output LOW Level)	$ CM_L $	$T_A = 25^\circ C$ $V_{CC} = 5V, I_f = 10mA$ $ V_{CM}  = 50V(\text{Peak})$ $V_{O(\text{MAX})} = 2.0V, R_L = 350\Omega$	5000	10000	-	V/ $\mu s$

**典型光电特性曲线 Typical Electro-Optical Characteristics Curves**

Fig.1 Low-level output voltage vs. Ambient temperature

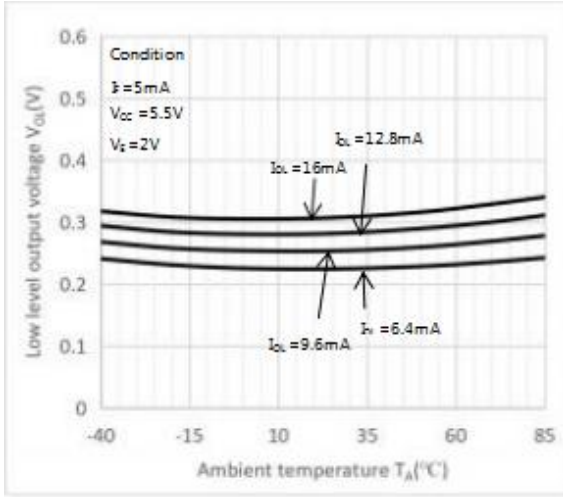

Fig.2 Forward current vs. Forward voltage

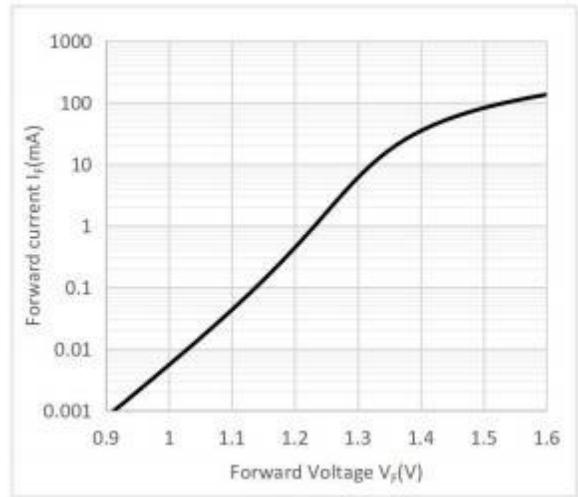

Fig.3 Propagation delay time vs. Forward current

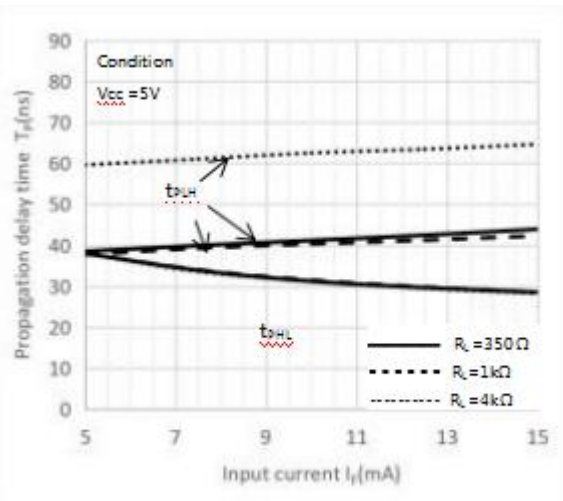

Fig.4 Low-level output current vs. Ambient temperature

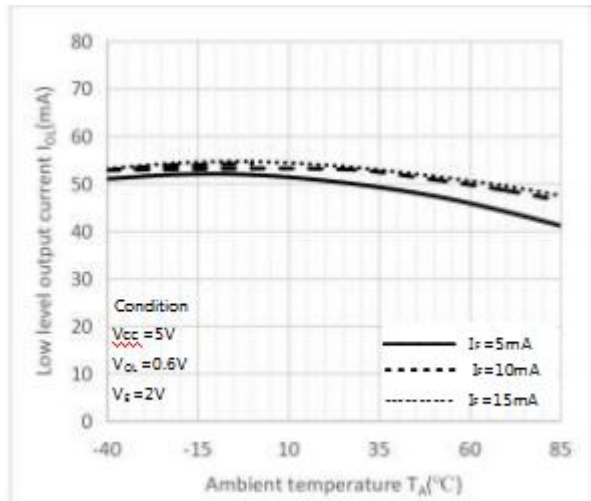

Fig.5 Input threshold current vs. Ambient temperature

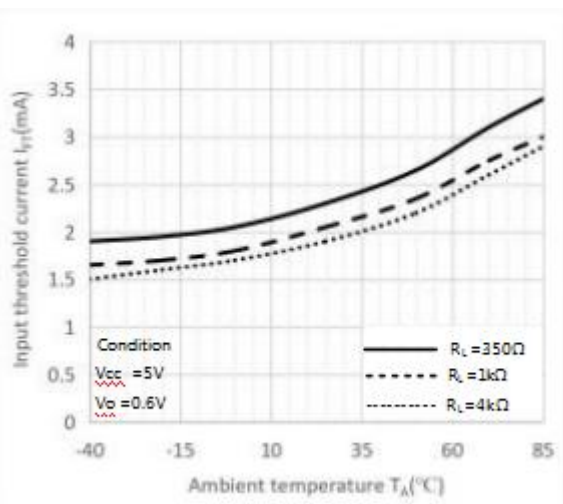

Fig.6 Output voltage vs. Forward current

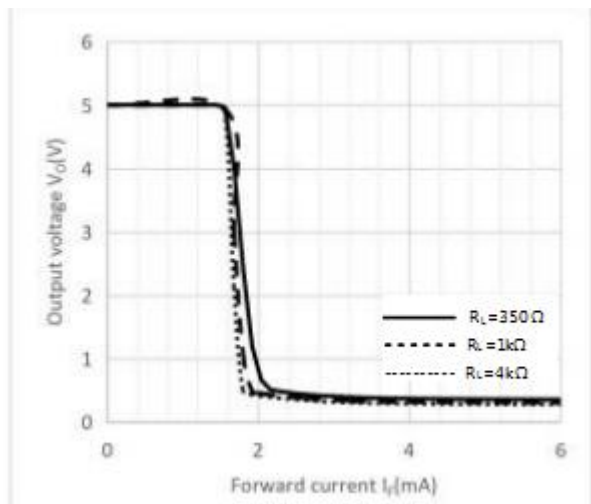



Fig.7 Pulse-width distortion vs. Ambient temperature

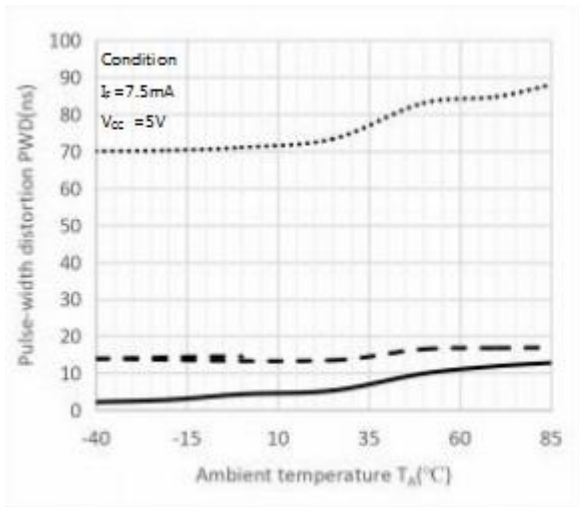

Fig.8 Switching time vs. Ambient temperature

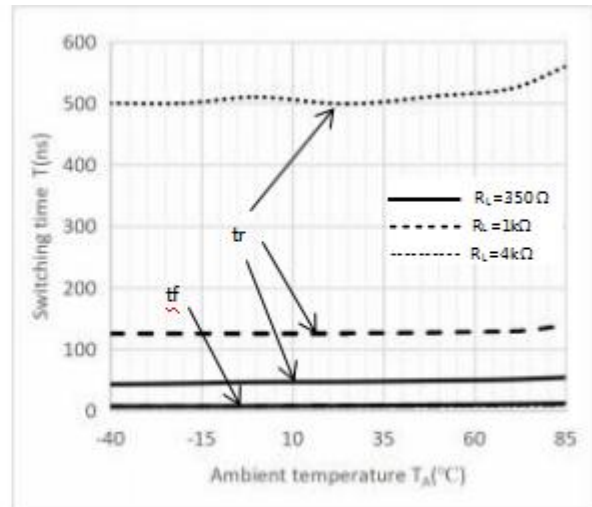

Fig.9 Propagation delay time vs. Ambient temperature

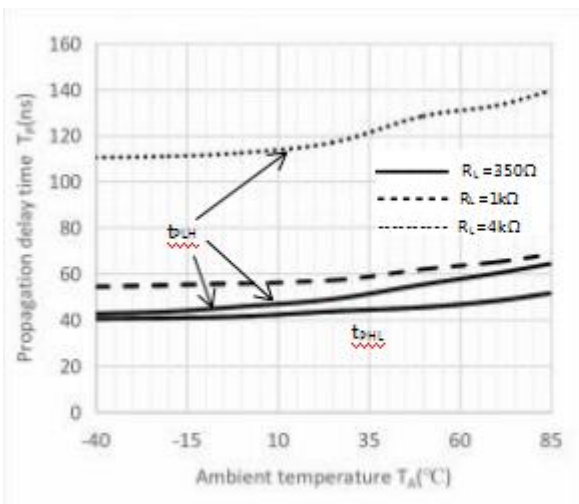

Fig.10 Propagation delay time vs. Ambient temperature

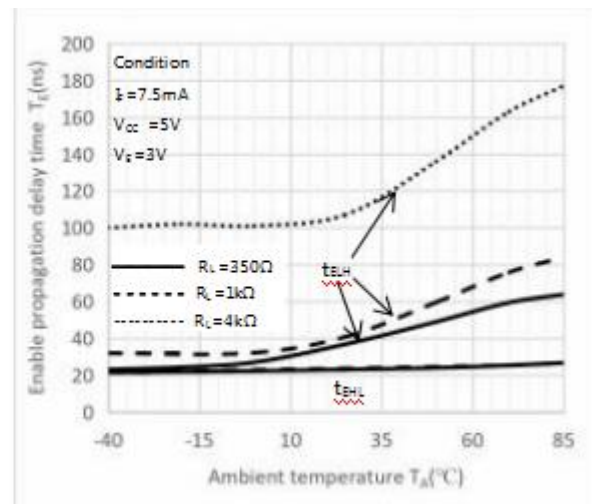
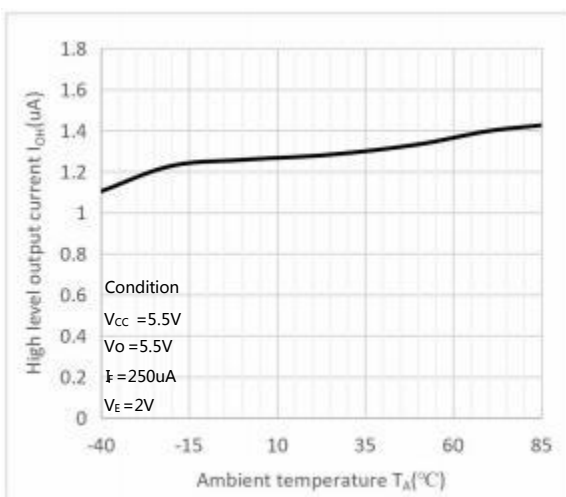
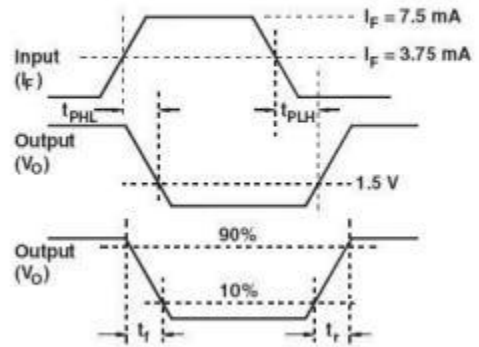
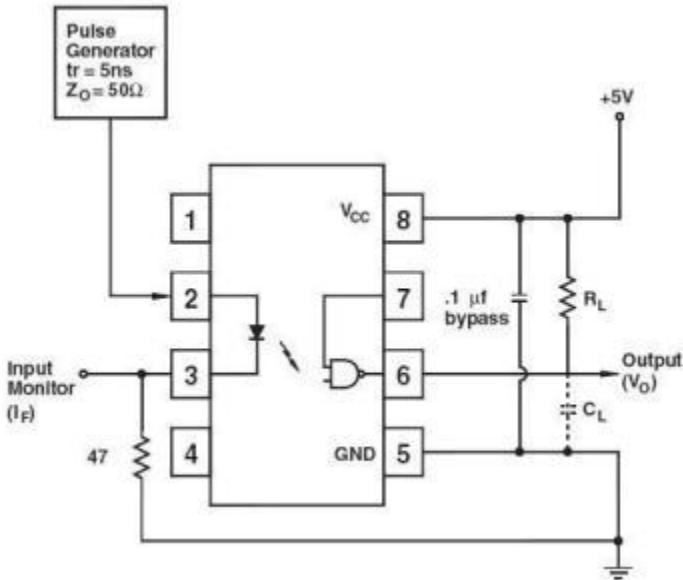
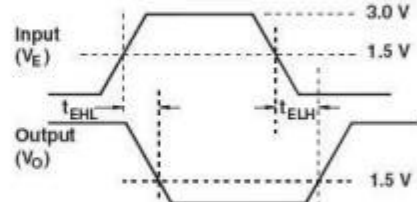
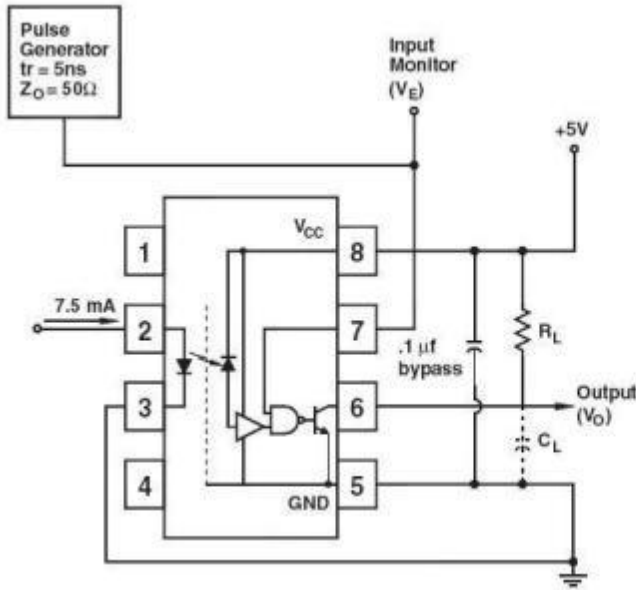

Fig.11 High-level output current vs. Ambient temperature



**传输延迟时间测试电路 Test Circuit for Propagation Delay Time**



**CMR 测试电路 Test Circuit for Common Mode Transient Immunity**

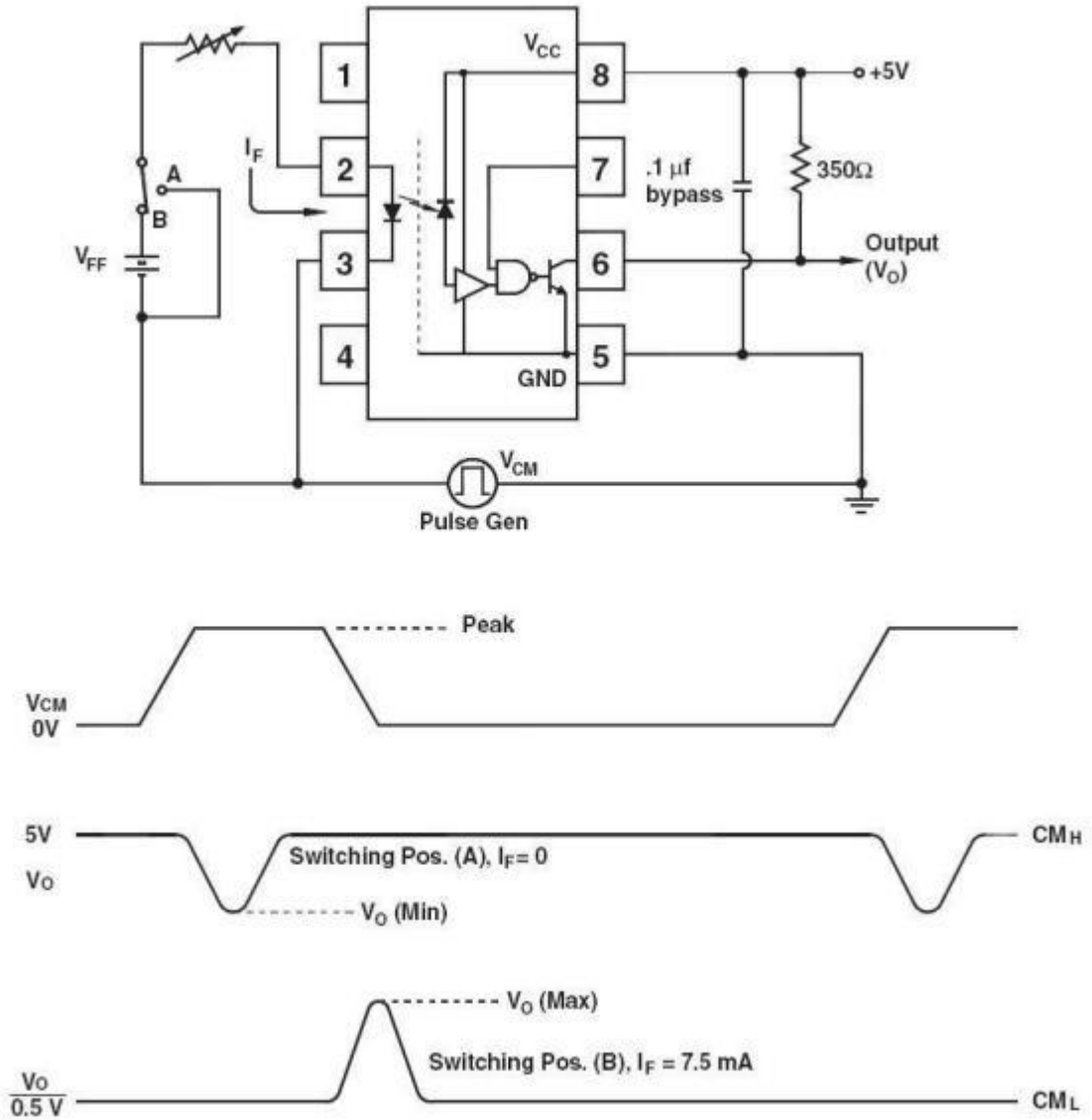

## 外形尺寸 Outline Dimensions

### DIP8

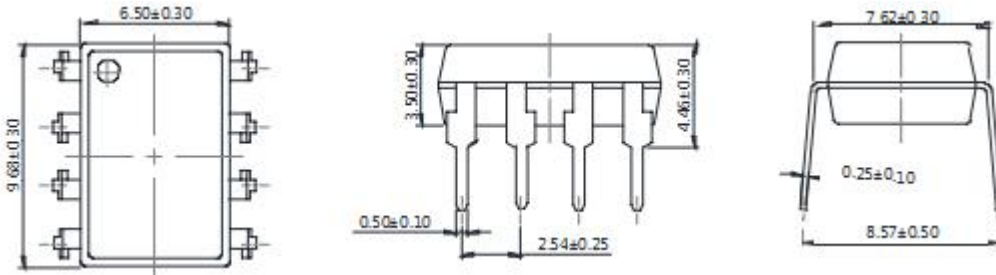

### SMD8

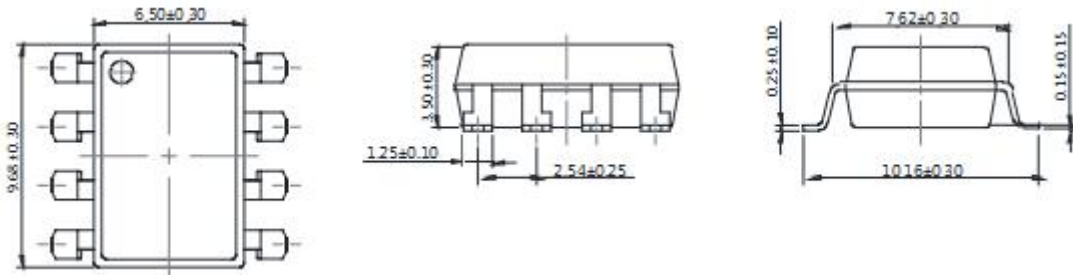

单位 Unit: mm

## 建议焊盘布局 Recommended Pad Layout

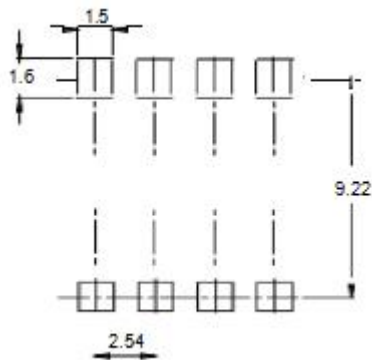

单位 Unit: mm

注：上图为产品正视图。

Note : The picture above is the front view of the product

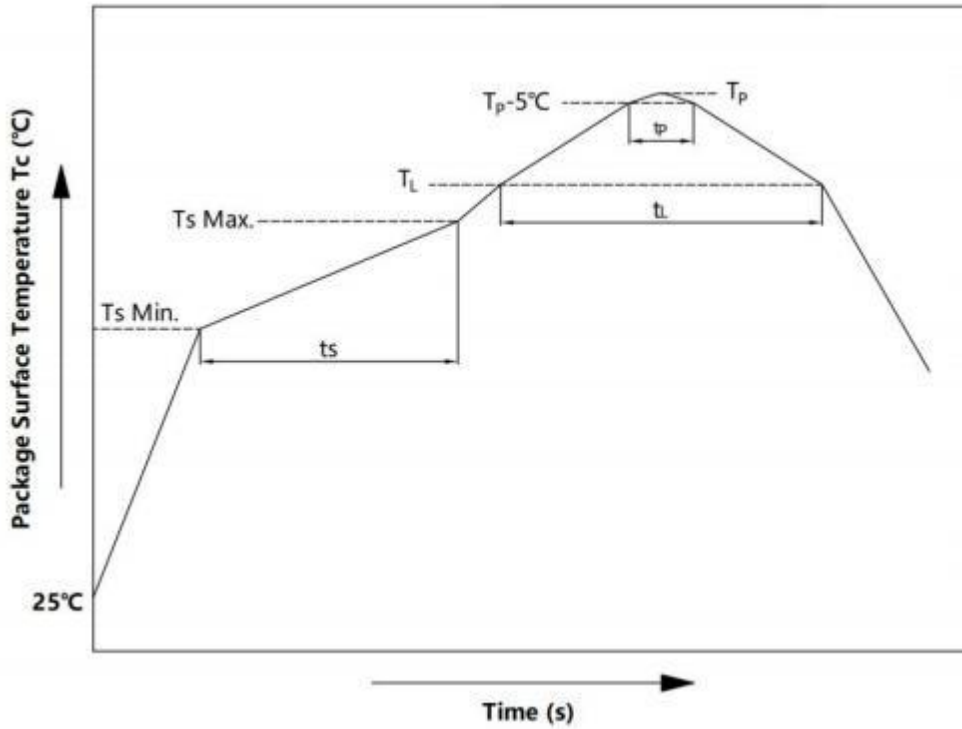
**回流焊温度曲线图 Solder Reflow Profile**

项目 Item	符号 Symbol	最小值 Min.	最大值 Max.	单位 Unit
预热温度 Preheat Temperature	$T_s$	150	200	$^\circ\text{C}$
预热时间 Preheat Time	$t_s$	60	120	s
升温速率 Ramp-Up Rate ( $T_L$ to $T_p$ )	-	-	3	$^\circ\text{C}/\text{s}$
液相线温度 Liquidus Temperature	$T_L$	217		$^\circ\text{C}$
时间高于 $T_L$ Time Above $T_L$	$t_L$	60	150	s
峰值温度 Peak Temperature	$T_p$	-	260	$^\circ\text{C}$
$T_c$ 在 $(T_p-5)$ 和 $T_p$ 之间的时间 Time During Which $T_c$ Is Between $(T_p-5)$ and $T_p$	$t_p$	-	30	s
降温速率 Ramp-down Rate ( $T_p$ to $T_L$ )	-	-	6	$^\circ\text{C}/\text{s}$

注：建议在所示的温度和时间条件下进行回流焊，最多不能超过三次。

Note: Reflow soldering is recommended at the temperatures and times shown, no more than three times.

### 波峰焊温度曲线图 Wave Soldering Profile

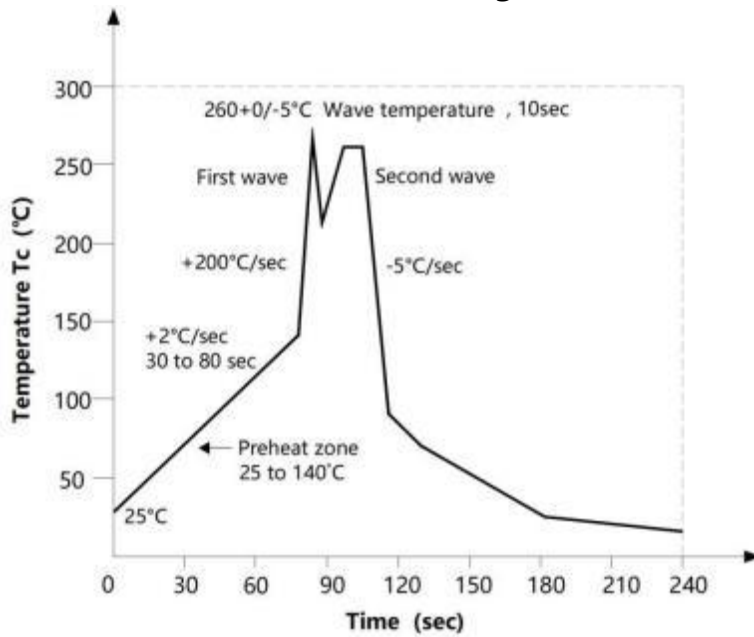

### 手工烙铁焊接 Soldering with hand soldering iron

- A. 手工烙铁焊仅用于产品返修或样品测试；  
Hand soldering iron is only used for product rework or sample testing;
- B. 手工烙铁焊要求：温度  $360^{\circ}\text{C} \pm 5^{\circ}\text{C}$ ，时间  $\leq 3\text{s}$ 。  
Manual soldering method Temperature:  $360^{\circ}\text{C} \pm 5^{\circ}\text{C}$ , within 3s.

## 包装 Packing

### ■ 汇总表 Summary table

封装形式	包装方式	盘数量	盒数量	箱数量	静电袋规格	盒规格	箱(双瓦楞)规格	备注
SMD8	卷盘 ( $\phi 330\text{mm}$ 蓝盘)	1 千只/盘	2 盘/盒	10 盒/箱	450*390*0.1mm	340*60*340mm	380*360*365 mm	首端空 50 个空格，末端空 100
DIP8	管装 (500*12*11mm)	45 只/管	50 管/盒	10 盒/箱	不适用	525*128*56mm	535*275*300 mm	每管使用蓝白胶塞，方向须一致
Package Type	Packing Form	Quantity per Reel	Quantity per Box	Quantity per Carton	Antistatic Bag Specification	Box Specification	Carton Specification	Note
SMD8	Reel( $\phi 330\text{mm}$ Blue)	1k pcs/reel	2 reels /box	10 boxes /ctn	450*390*0.1mm	340*60*340 mm	380*360*365 mm	Leave 50 spaces at the beginning and 100 spaces at the end
DIP8	Tube (500*12*11mm)	45pcs /tube	50 tubes/box	10boxes/ctn	NA	525*128*56 mm	535*275*300 mm	Endplug (blue) and Endplug (white) keep the direction

### ■ 编带包装 Tape & Reel

- 1) 每箱数量：22500 只。  
Qty/ctn：22500pcs
- 2) 内包装：Inner packing：
  - i. 每条管 45 只。  
45pcs/tube
  - ii. 每盒 50 条管。  
50 tubes/box
- 3) 示意图 Schematic：

### ■ 编带包装 Tape & Reel

- 1) 每卷数量：1000 只。  
Qty/reel：1000 pcs.
- 2) 每箱数量：20000 只。  
Qty/ctn：20000 pcs.
- 3) 内包装：每盒 2 盘。  
Inner packing：2 reels/box.
- 4) 示意图 Schematic：

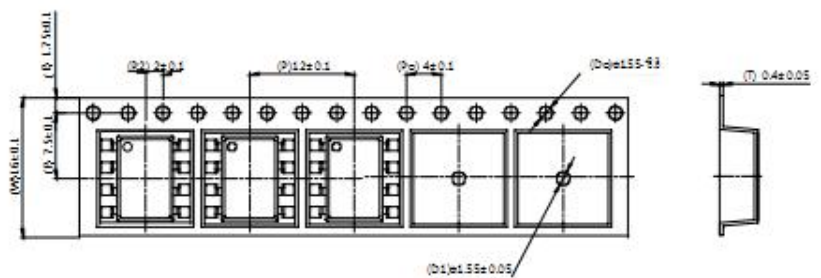
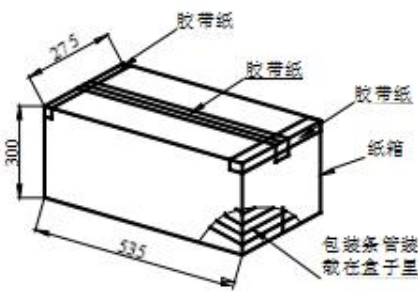

单位 Unit：mm

## 注意 Attention

- 奥特持续不断改进质量、可靠性、功能或设计，保留此文件更改的权利恕不另行通知。  
AOTE continuously improve quality, reliability, function or design. We reserve the right to change this document without notice.
- 请遵守产品规格书使用，奥特不对使用时不符合产品规格书条件而导致的质量问题负责。  
Please use in accordance with the product specification. AOTE is not responsible for the quality problems caused by non-compliance with the product specifications.
- 对于需要高可靠性或安全性的设备/装置需求，请联系我们的销售人员。  
For equipment/devices where high reliability or safety is required, please contact our sales representatives.
- 当需要用于任何“特定”应用时，请咨询我们的销售人员。  
When requiring a device for any “specific” application, please contact our sales in advice.
- 如对文件中表述的内容有疑问，欢迎联系我们。  
If you have any questions about the contents of the document, please contact us.



## X-ON Electronics

Largest Supplier of Electrical and Electronic Components

*Click to view similar products for [AOTE manufacturer](#):*

Other Similar products are found below :

[4N25](#) [4N35](#) [6N136M](#) [6N136S](#) [6N137M](#) [6N137S](#) [AT0530-CuH-S](#) [AT0531-CuH-S](#) [AT074L-CuH-S](#) [AT075L-CuH-S](#) [AT1018-CuH-L](#)  
[AT1019-CuH-L](#) [AT172-CuH-S](#) [AT174-CuH-S](#) [AT212-CuH-D](#) [AT222-CuH-D](#) [AT222-CuH-S](#) [AT223-CuH-D](#) [AT223-CuH-S](#) [AT226-CuH-D](#)  
[AT226-CuH-S](#) [AT3020-CuH-DE](#) [AT3021-CuH-DE](#) [AT3021-CuH-SE](#) [AT3022-CuH-DE](#) [AT3022-CuH-SE](#) [AT3023-CuH-DE](#) [AT3023-CuH-](#)  
[SE](#) [AT3041-CuH-DE](#) [AT3042-CuH-DE](#) [AT3042-CuH-SE](#) [AT3043-CuH-DE](#) [AT3043-CuH-SE](#) [AT3051-CuH-DE](#) [AT3051-CuH-SE](#)  
[AT3052-CuH-DE](#) [AT3052-CuH-SE](#) [AT3053-CuH-DE](#) [AT3062-CuH-DE](#) [AT3062-CuH-SE](#) [AT3063-CuH-DE](#) [AT3063-CuH-SE](#) [AT3081-](#)  
[CuH-DE](#) [AT3081-CuH-SE](#) [AT3082-CuH-DE](#) [AT3082-CuH-SE](#) [AT3083-CuH-DE](#) [AT3083-CuH-SE](#) [AT314-CuH-P](#) [AT316J-CuH-S](#)