

**达林顿光耦**  
**Darlington Photo**  
**Coupler**

**AT4NXX**

**Product Data Sheet**

**AOTE DCC**  
**RELEASE**

**台湾奥特半导体科技有限公司**

TAIWAN AOTE SEMICONDUCTOR TECHNOLOGY CO.,LTD

[www.aotesemi.com](http://www.aotesemi.com)

## 概述 Description

AT4NXX是一款由 GaAs发光二极管和达林顿晶体管组成的光电耦合器。可以在保持驱动电路和负载电路之间的高度隔离的同时实现开关，具有使用寿命长、速度快等优点能让它替代常规继电器。

The AT4NXX is a photoelectric coupler composed of GaAs light-emitting diode and Darlington transistor. The switch can be realized while maintaining the high isolation between the drive circuit and the load circuit, which has the advantages of long service life and fast speed, allowing it to replace the conventional relay.

## 特性 Features

- 电流转换比(CTR)范围:  $CTR \geq 500\%$   
Current to current ratio range:  $CTR \geq 500\%$
- 输入-输出隔离电压:  $V_{iso} = 5000 \text{ V rms}$   
Input-output isolation voltage:  $V_{iso} = 5000 \text{ Vrms}$
- 输入-输出隔离电阻: 典型值  $R_{iso} = 10^{11} \Omega$   
Input-output isolation resistance: Typical  $R_{iso} = 10^{11} \Omega$
- 符合安规标准: UL 1577, VDE DIN EN60747-5-5 (VDE 0884-5), CQC11-471543-2022  
Meet Safety standard: UL 1577, VDE DIN EN60747-5-5 (VDE 0884-5), CQC11-471543-2022

## 应用 Applications

- 开关电源  
Switching power supply
- 工业控制, 测量仪器  
Industrial control, measuring instruments
- 可编程控制器  
Programmable controller
- 家用电器  
Household appliances

## 封装和原理图 Package and Schematic Diagram

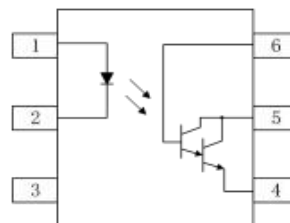
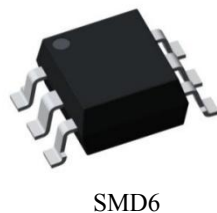
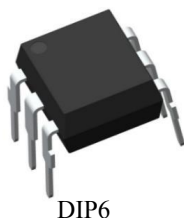

### Pin Configuration

1. Anode
2. Cathode
3. NC
4. Emitter
5. Collector
6. Base



## 产品型号命名规则 Order Code

# AT 4NXX - UN Y - W (V) (ZZ)

①            ②            ③    ④            ⑤            ⑥            ⑦

- ① 公司代码 Company Code ( AT: 奥特AOTE )
- ② 产品系列 Product Series ( XX: 29, 30,31,32,33 )
- ③ 框架类型 Lead Frame ( Cu: 铜框架 Copper )
- ④ 树脂类型 Epoxy ( H: 无卤 Halogen-free )
- ⑤ 封装形式 Package ( D: DIP ; S: SMD )
- ⑥ 器件工作温度范围 Device Operating Temperature Range ( 特殊范围需填或者空白 Special Range or None )
- ⑦ 内部补充代码 Internal Supplementary Code ( 数字或者空白 Number or None )

## 印字信息 Marking Information

- 印字中 “” 为奥特品牌 LOGO  
 “” denotes LOGO
- 印字中的 “XX” 代表产品分档：29、30、31、32、33  
 “XX” denotes the classification：29、30、31、32、33
- 印字中 “Y” 代表年份；A(2018),B(2019),C(2020).....  
 “Y” denotes YEAR：A(2018), B(2019), C(2020).....
- 印字中 “WW” 代表周号  
 “WW” denotes Week’ s number
- 印字中 “E” 代表内部代码  
 “E” denotes Internal code
- 印字中的 “H” 代表无卤  
 “H” denotes Halogen-free

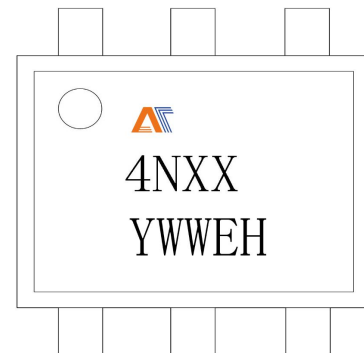

**绝缘和安规信息 Insulation and Safety related specifications**

项目 Item	符号 Symbol	数值 Value	单位 Unit	备注 Remark
爬电距离 Creepage Distance	L	>7.6	mm	从输入端到输出端，沿本体最短距离路径 Measured from input terminals to output terminals, shortest distance path along body
电气间隙 Clearance Distance	L	>7.6	mm	从输入端到输出端，通过空气的最短距离 Measured from input terminals to output terminals, shortest distance through air
绝缘距离 Insulation Thickness	DTI	> 0.4	mm	发射器和探测器之间的绝缘厚度 Insulation thickness between emitter and detector
峰值隔离电压 Peak Isolation Voltage	V <sub>IORM</sub>	1500	V <sub>peak</sub>	DIN/EN/IEC EN60747-5-5
瞬态隔离电压 Transient isolation voltage	V <sub>IOTM</sub>	7000	V <sub>peak</sub>	DIN/EN/IEC EN60747-5-5
隔离电压 Isolation Voltage	V <sub>iso</sub>	>5000	V <sub>rms</sub>	For 1 min

**极限参数 Absolute Maximum Ratings (Ta = 25°C)**

	参数 Parameter	符号 Symbol	额定值 Rating	单位 Unit
发射端 Input	正向电流 Forward Current	I <sub>F</sub>	60	mA
	峰值正向电流(1us, 脉冲) Peak forward current (1us, pulse)	I <sub>FP</sub>	1	A
	反向电压 Reverse Voltage	V <sub>R</sub>	3	V
	功耗 Power Dissipation	P <sub>D</sub>	100	mW
接收端 output	集电极功耗 Collector Power Dissipation	P <sub>C</sub>	150	mW
	集电极电流 Collector Current	I <sub>C</sub>	100	mA
	集电极-基极电压 Collector-Base voltage	V <sub>CBO</sub>	50	V
	发电极-基极电压 Emitter-Base voltage	V <sub>EBO</sub>	8	V
	集电极-发射极电压 Collector-Emitter voltage	V <sub>CEO</sub>	30	V
	发射极-集电极电压 Emitter-Collector voltage	V <sub>ECO</sub>	5	V
总功耗 Total Power Dissipation	P <sub>tot</sub>	250	mW	
输入输出瞬态耐受电压 Input-output isolation voltage	V <sub>iso</sub>	5000	V <sub>rms</sub>	

参数 Parameter	符号 Symbol	额定值 Rating	单位 Unit
工作温度 Operating Temperature	$T_{opr}$	-55 ~ +100	°C
存储温度 Storage Temperature	$T_{stg}$	-55 ~ +125	°C
焊接温度 Soldering Temperature	$T_{sol}$	260	°C

**产品特性参数 Electro-optical Characteristics (Ta = 25°C)**

参数 Parameter		符号 Symbol	条件 Condition	最小 Min.	典型 Typ.	最大 Max.	单位 Unit
发射端 Input	正向电压 Forward Voltage	$V_F$	$I_F = 10mA$	-	1.3	1.5	V
	反向电流 Reverse Current	$I_R$	$V_R = 3V$	-	-	10	μA
	输入电容 Terminal Capacitance	$C_t$	$V=0, F=1KHz$	-	50	-	pF
接收端 Output	集电极暗电流 Collector Dark Current	$I_{CEO}$	$V_{CE} = 10V$	-	-	100	nA
	集电极-基极击穿电压 Collector-Base Breakdown Voltage	$BV_{CBO}$	$I_b = 0.1mA, I_f = 0$	50	-	-	V
	集电极-发射极击穿电压 Collector-Emitter Breakdown Voltage	$BV_{CEO}$	$I_c = 0.1mA, I_f = 0$	40	-	-	V
	发射极-集电极击穿电压 Emitter-Collector Breakdown Voltage	$BV_{ECO}$	$I_e = 0.1mA, I_f = 0$	7	-	-	V
传输特性 Transfer Characteristics	电流传输比 Current Transfer Ratio	4N31	$I_F = 10mA, V_{CE} = 10V$	50	-	-	%
		4N29、4N30		100	-	-	%
		4N32、4N33		500	-	-	%
	集电极-发射极饱和压降 Collector-Emitter Saturation Voltage	$V_{CE(sat)}$	$I_F = 8mA, I_C = 2mA$	-	-	1	V
	隔离电阻 Isolation Resistance	$R_{ISO}$	DC=500V 40~60%R.H.	-	$10^{11}$	-	Ω
	隔离电容 Isolation capacitance	$C_{ISO}$	$V=0, f=1MHz$	-	0.8	-	pF
	开启时间 Turn-on Time	$T_{on}$	$V_{CE} = 10V,$ $I_c = 50mA, R_L = 100\Omega$	-	-	5	μs
	关断时间 Turn-off Time	$T_{off}$		-	-	100	μs

 注\*：电流传输比= $I_C/I_F \times 100\%$ 。

 Note\*：CTR= $I_C/I_F \times 100\%$ 。

## 典型光电特性曲线 Typical Electro-Optical Characteristics Curves

Fig.1 Forward Current vs. Forward Voltage

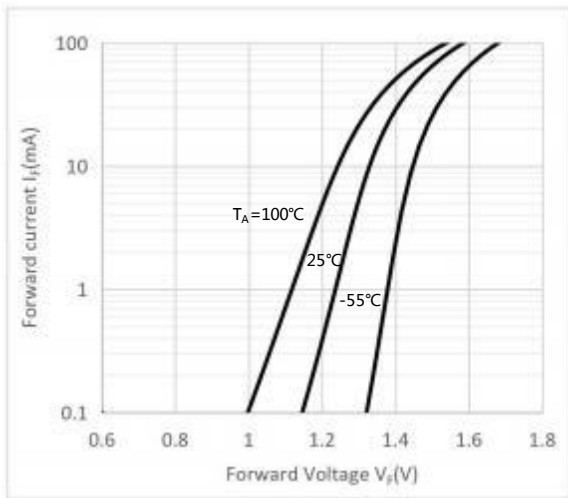

Fig.2 Current Transfer Ratio vs. Ambient Temperature

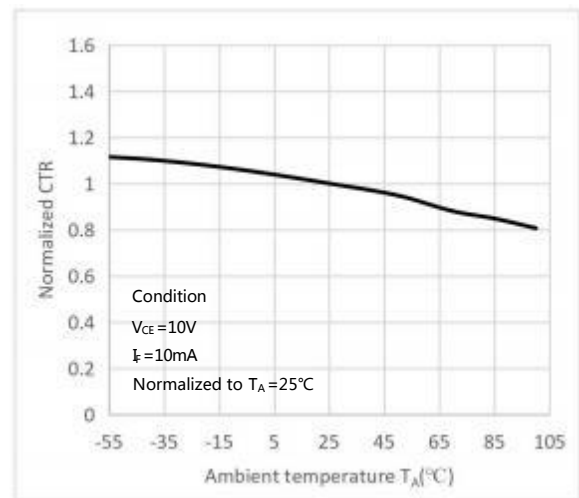

Fig.3 Normalized Current Transfer Ratio vs. Forward Current

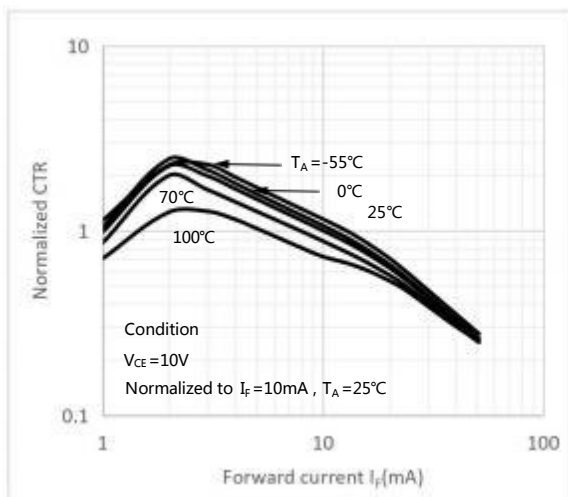

Fig.4 Collector Dark Current vs. Ambient Temperature

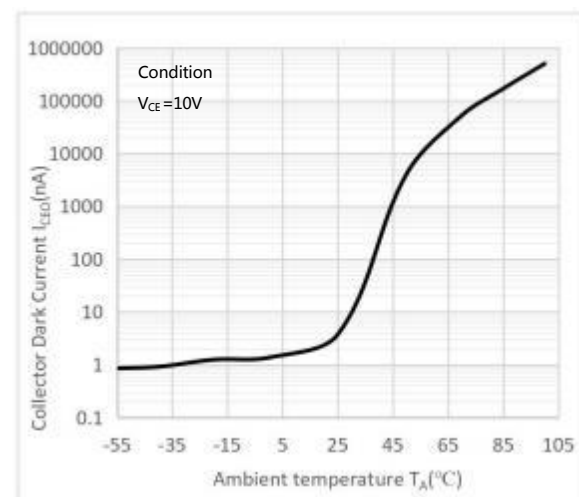

Fig 5. Turn-on Time vs Forward Current

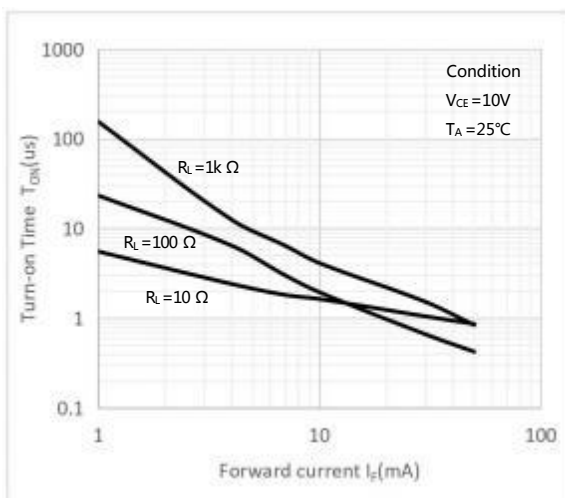
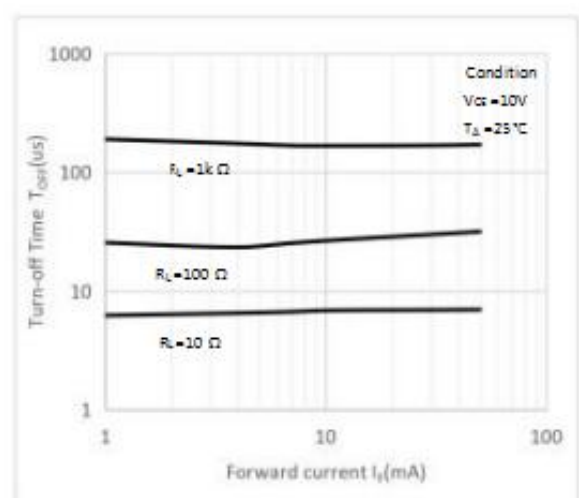
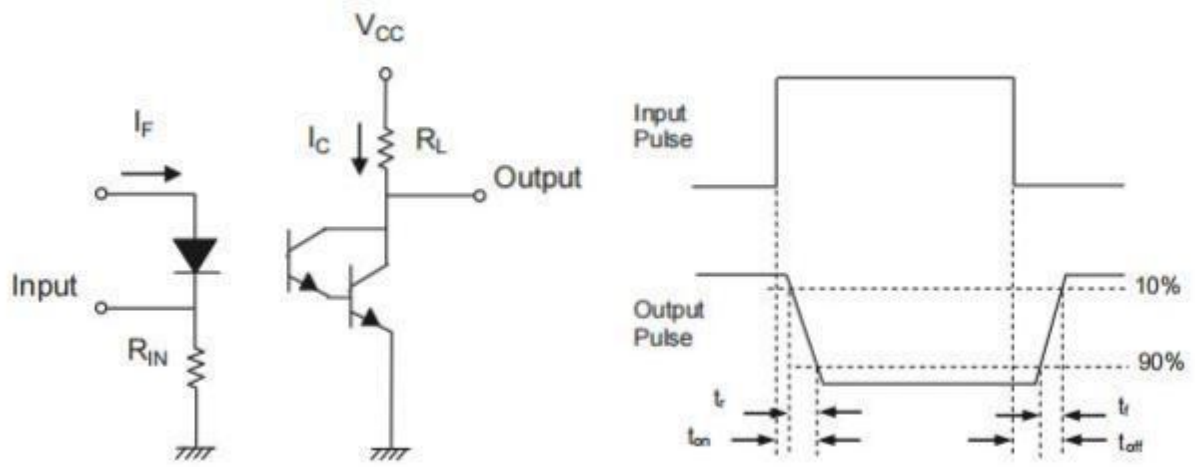

Fig 6. Turn-off Time vs Forward Current



**开关时间测试电路 Switching Time Test Circuit**



## 外形尺寸 Outline Dimensions

DIP6

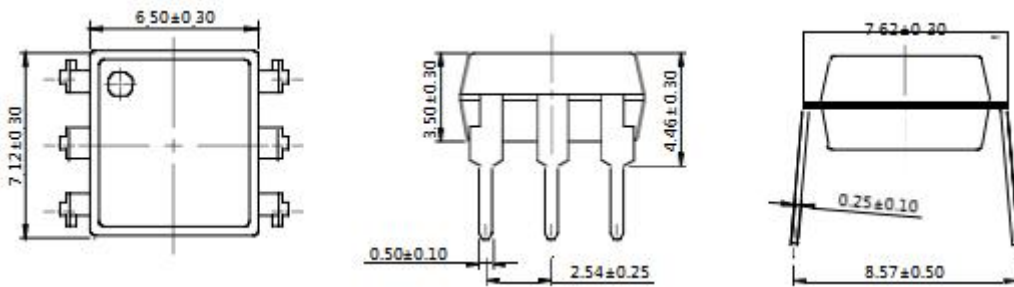

SMD6

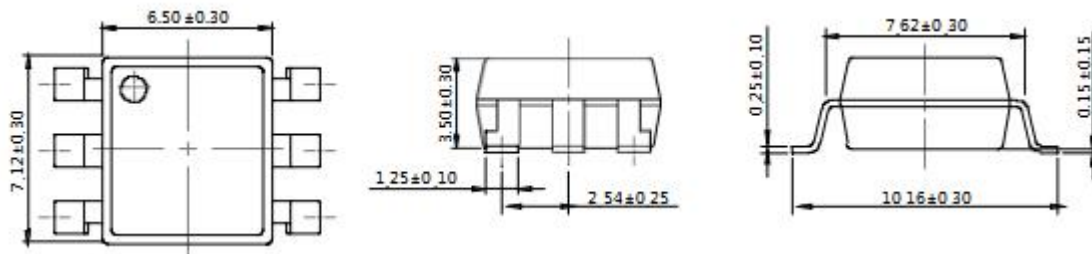

单位 Unit: mm

## 建议焊盘布局 Recommended Pad Layout

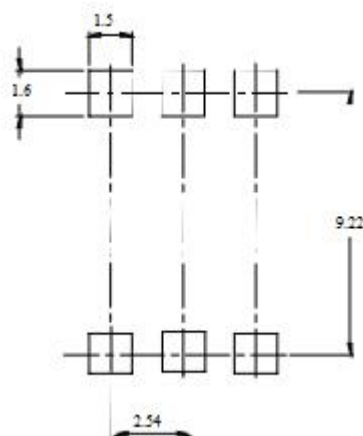

单位 Unit: mm

注：上图为产品正视图。

Note : The picture above is the front view of the product.



## 回流焊温度曲线图 Solder Reflow Profile



项目 Item	符号 Symbol	最小值 Min.	最大值 Max.	单位 Unit
预热温度 Preheat Temperature	$T_s$	150	200	$^\circ\text{C}$
预热时间 Preheat Time	$t_s$	60	120	s
升温速率 Ramp-Up Rate ( $T_L$ to $T_P$ )	-	-	3	$^\circ\text{C/s}$
液相线温度 Liquidus Temperature	$T_L$	217		$^\circ\text{C}$
时间高于 $T_L$ Time Above $T_L$	$t_L$	60	150	s
峰值温度 Peak Temperature	$T_P$	-	260	$^\circ\text{C}$
$T_c$ 在 $(T_P - 5)$ 和 $T_P$ 之间的时间 Time During Which $T_c$ Is Between $(T_P - 5)$ and $T_P$	$t_p$	-	30	s
降温速率 Ramp-down Rate ( $T_P$ to $T_L$ )	-	-	6	$^\circ\text{C/s}$

注 Note :

建议在所示的温度和时间条件下进行回流焊，最多不能超过三次；

Reflow soldering is recommended at the temperatures and times shown, no more than three times;

## 波峰焊温度曲线图 Wave Soldering Profile

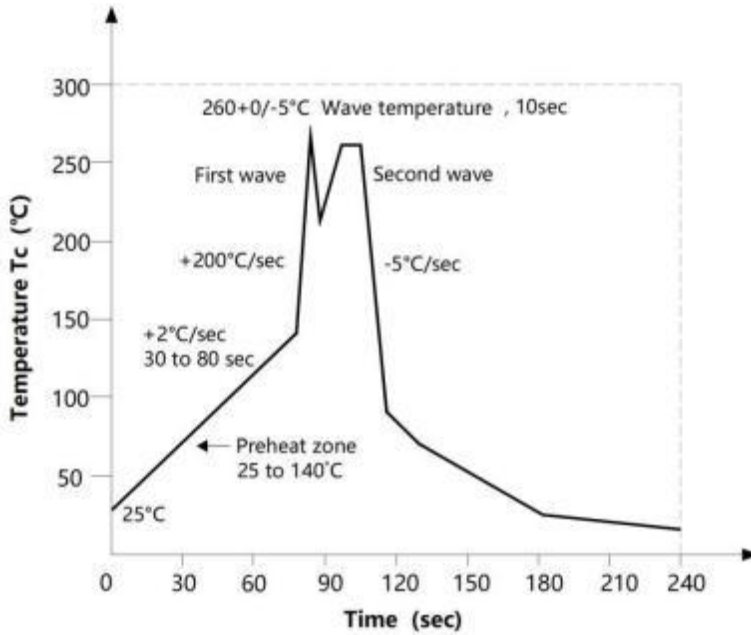

## 手工烙铁焊接 Soldering with hand soldering iron

- A. 手工烙铁焊仅用于产品返修或样品测试；  
Hand soldering iron is only used for product rework or sample testing;
- B. 手工烙铁焊要求：温度  $360^{\circ}\text{C} \pm 5^{\circ}\text{C}$ ，时间  $\leq 3\text{s}$ 。  
Manual soldering method Temperature:  $360^{\circ}\text{C} \pm 5^{\circ}\text{C}$ , within 3s.

## 包装 Packing

### ■ 汇总表 Summary table

封装形式	包装方式	盘数量	盒数量	箱数量	静电袋规格	盒规格	箱(双瓦楞)规格	备注
DIP6	管装 (500*12*11mm)	65 只/管	50 管/盒	10 盒/箱	不适用	525*128*56mm	535*275*300mm	每管使用蓝白胶塞，方向须一致
SMD6	卷盘 (φ330mm 蓝盘)	1 千只/盘	2 盘/盒	10 盒/箱	450*390*0.1mm	340*60*340mm	620*360*365mm	首尾端至少空 200 毫米
Package Type	Packing Form	Quantity per Reel	Quantity per Box	Quantity per Carton	Antistatic Bag Specification	Box Specification	Carton Specification	Note
DIP6	Tube (500*12*11mm)	65 pcs/tube	50 tubes/box	10 boxes/ctn	Not applicable	525*128*56mm	535*275*300mm	Use blue and white rubber stoppers for each tube, with the same direction
SMD6	Reel (φ330mm Blue)	1k pcs/reel	2 reels/box	10 boxes /ctn	450*390*0.1mm	340*60*340mm	620*360*365mm	Guard band 200mm min.

### ■ 编带包装 Tape & Reel

- 1) 每卷数量：1000 只。  
Qty/reel : 1000 pcs.
- 2) 每箱数量：20000 只。  
Qty/ctn : 20000 pcs.
- 3) 内包装：每盒 2 盘。  
Inner packing : 2 reels/box.
- 4) 示意图 Schematic :

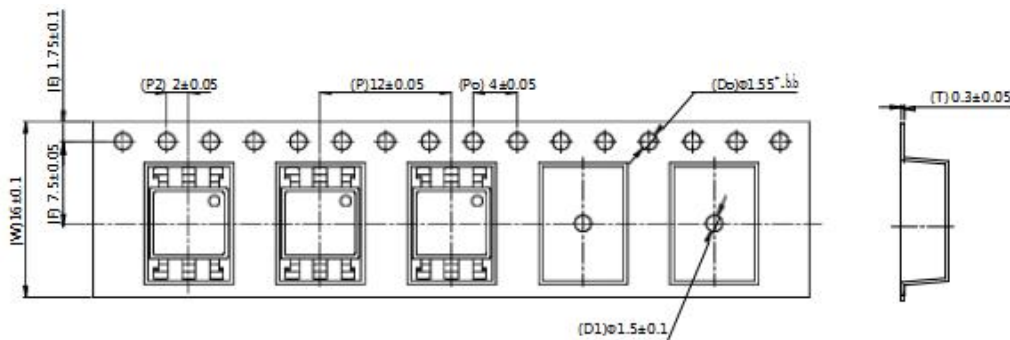

### ■ 管条包装 Tape & Tube

- 1) 每管数量：65 只。  
Qty/Tube : 65 pcs.
- 2) 每箱数量：32500 只。  
Qty/ctn : 32500 pcs.
- 3) 内包装：每盒 50 管。  
Inner packing : 50 Tube/box.
- 4) 示意图 Schematic

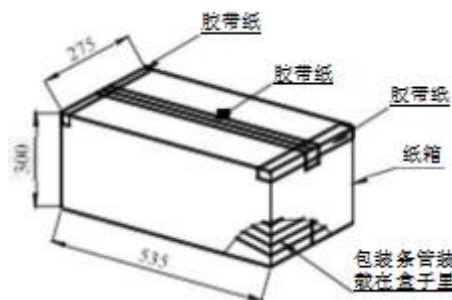

单位/Unit : mm

## 注意 Attention

- 奥特持续不断改进质量、可靠性、功能或设计，保留此文件更改的权利恕不另行通知。  
AOTE continuously improve quality, reliability, function and design. We reserve the right to change this document without prior notice.
- 请遵守产品规格书使用，奥特不对使用时不符合产品规格书条件而导致的质量问题负责。  
Please use in accordance with the product specification. AOTE is not responsible for the quality problems caused by non-compliance with the product specifications.
- 对于需要高可靠性或安全性的设备/装置需求，请联系我们的销售人员。  
For equipment/devices requiring high reliability or safety, please contact our sales representatives.
- 当需要用于任何“特定”应用时，请咨询我们的销售人员。  
When requiring a device for any “specific” application, please contact our sales in advice.
- 如对文件中表述的内容有疑问，欢迎联系我们。  
If you have any questions about the contents of the document, please contact us.

## X-ON Electronics

Largest Supplier of Electrical and Electronic Components

*Click to view similar products for [Transistor Output Optocouplers](#) category:*

*Click to view products by [AOTE](#) manufacturer:*

Other Similar products are found below :

[LTV-814S-TA](#) [LTV-852S](#) [66095-001](#) [PS2561-1-A](#) [PS2561A-1-W-A](#) [PS2561L1-1-A](#) [PS2561L-1-V-A](#) [PS2706-1-A](#) [PS2815-1-A](#) [MRF658](#)  
[ELD207\(TA\)](#) [ILD2-X006](#) [ILQ615-3X016](#) [LDA102S](#) [SFH615A-4XSM TR](#) [PS2561DL-1Y-F3-A](#) [PS2561L1-1-L-A](#) [PS2562-1-V-A](#) [PS2565L-](#)  
[1-A](#) [PS2581L2-A](#) [PS2701A-1-F3-P-A](#) [PS2711-1-A](#) [PS2801-1-F3-P-A](#) [PS2833-4-A](#) [PS2841-4A-AX](#) [LTV-702FS](#) [LTV-702V](#) [LTV-702VB](#)  
[LTV-816S-TA](#) [TCET2100](#) [TLP290-4\(E\(T](#) [IL215AT](#) [WPPC-A11066AA](#) [WPPC-A11066AD](#) [WPPC-A11084ASS](#) [WPPC-A21068AA](#) [WPPC-](#)  
[D11066AA](#) [WPPC-D21068ED](#) [WPPC-D410616EA](#) [WPPC-D410616ED](#) [X4IAC24A](#) [4N26-X001](#) [EL1010\(TA\)-VG](#) [SFH600-2X007](#)  
[TCMT1118](#) [VO206AT](#) [WPPC-D21068EA](#) [WPPC-D11064AD](#) [WPPC-A410616AD](#) [WPPC-A21068AD](#)