



达林顿光耦

Darlington Photo Coupler

AT4N33

Product Data Sheet

AOTE DCC
RELEASE

台湾奥特半导体科技有限公司

TAIWAN AOTE SEMICONDUCTOR TECHNOLOGY CO.,LTD

www.aotesemi.com

概述 Description

AT4N33 将AlGaAs红外发射二极管组合为所述发射器光学耦合到硅平面达林顿光电晶体管塑料DIP6包装中的探测器,不同的引线成型选项。

The AT4N33 combine an AlGaAs infrared emitting diode as the emitter which is optically coupled to a silicon planar darlington phototransistor detector in a plastic DIP6 package with different lead forming options.

特性 Features

- 高隔离:5000 VRMS
High isolation 5000 VRMS
- 带晶体管输出的直流输入
DC input with transistor output
- 工作温度范围:-55°C至110°C
Operating temperature range - 55 °C to 110 °C
- 符合安规标准： UL 1577 ， VDE DIN EN60747-5-5 (VDE 0884-5) ， CQC11-471543-2022
Meet Safety standard I: UL 1577, VDE DIN EN60747-5-5 (VDE 0884-5) ， CQC11-471543-2022

应用 Applications

- 低功率逻辑电路
Low power logic circuits
- 电信设备
Telecommunications equipment
- 便携式电子设备
Portable electronics
- 不同电位和阻抗的接口耦合系统
Interfacing coupling systems of different potentials and impedances

封装和原理图 Package and Schematic Diagram



SMD6



SOP6



Pin Configuration



1.Anode	4.Emitter
2.Cathode	5.Collector
3.NC	6.Base

产品型号命名规则 Order Code
AT 4N33 - UN Y - W (V) (ZZ)

① ② ③ ④ ⑤ ⑥ ⑦

- ① 公司代码 Company Code (AT: 奥特 Aote)
- ② 产品系列 Product Series (4N33)
- ③ 框架类型 Lead Frame (Cu: 铜框架 Copper)
- ④ 树脂类型 Epoxy Type (H: 无卤 Halogen-free)
- ⑤ 封装形式 Package (D: DIP ; S: SMD)
- ⑥ 器件工作温度范围 Device Operating Temperature Range (特殊范围需填或者空白 Special Range need to be filled in or left blank)
- ⑦ 内部补充代码 Internal Supplementary Code (数字或者空白 Number or None)

印字信息 Marking Information

- 印字中 “” 为奥特品牌 LOGO
“” denotes LOGO
- 印字中 “Y” 代表年份 ; A(2018),B(2019),C(2020)
“Y” denotes YEAR : A(2018), B(2019), C(2020)
- 印字中 “WW” 代表周号
“WW” denotes Week’ s number
- 印字中 “N” 代表星期几
“N” denotes the day of the week
- 印字中的 “H” 代表无卤
“H” denotes Halogen-free

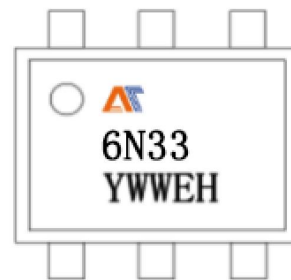

极限参数 Absolute Maximum Ratings (Ta = 25°C)

参数 Parameter		符号 Symbol	值 VALUE	单位 Unit
发射端 Input	正向电流 Forward Current	IF	60	mA
	峰值正向电流 (t=10μs) Peak Forward Current(t=10μs)	IFM	1	A
	反向电压 Reverse Voltage	Vr	6	V
	功耗 Input Power Dissipation	Pd	120	mW
接收端 output	集电极-发射极电压 Collector - Emitter Voltage	Vceo	55	V
	集电极-基极击穿电压 Collector-Base Breakdown Voltage	Vcbo	55	V
	发射极-集电极电压 Emitter - Collector Voltage	Veco	7	V
	发射极-基极击穿电压 Emitter-Base Breakdown Voltage	Vebo	7	V
	电极电流 Collector Current	Ic	150	mA
	功耗 (TA=25°C) Power Dissipation(TA=25°C)	Pc	150	mA
总功率 Total Power Dissipation	P _{tot}	200	mW	
工作温度 Operating Temperature	T _{opr}	-55	°C	
存储温度 Storage Temperature	T _{stg}	-55	°C	
隔离电压 Isolation Voltage	Viso	5000	V _{rms}	

Note 1. AC For 1 Minute, R.H. = 40 ~ 60%

Note 2. For 10 seconds

推荐操作条件 Recommended Operating Conditions

参数 Parameter	符号 Symbol	最小值 Min	最大值 Max	单位 Unit
正向电压 Forward Voltage	VF	1.24	14	V
反向电流 Reverse Current	IR	-	10	μA
输入电容 Input Capacitance	Cin	50	-	pF

特性参数 Electro-optical Characteristics (Ta = 25°C)

参数 Parameter	符号 Symbol	条件 Condition	最小 Min.	典型 Typ.	最大 Max.	单位 Unit	
发射端 Input	集电极暗电流 Collector Dark Current	ICEO	$I_f=10\text{ mA}$	-	1.24	14	V
	集电极-发射极击穿电压 Collector-Emitter Breakdown Voltage	BVCEO	$V_R=6\text{ V}$	-	1.4	1.5	V
	集电极基极击穿电压 Collector-Base Breakdown Voltage	BVCBO	$V=0, f=1\text{ KHz}$	-	-	10	μA
	发射极-集电极击穿电压 Emitter-Collector Breakdown Voltage	BVCEO	$I_f=1.6\text{ mA}$	-	50	-	pF
接收端 Output	集电极暗电流 Collector Dark Current	ICEO	$V_{CE}=10\text{ V}$	-	-	100	nA
	集电极-发射极击穿电压 Collector-Emitter Breakdown Voltage	BVCEO	$I_C=10.1\text{ mA}$	55	-	-	V
传输特性 Transfer Characteristics	电流传输比 Current Transfer Ratio	V_{OL}	$I_f=10\text{ mA}, V_{CE}=10\text{ V}$	-	500	-	%
	集电极-发射极击穿电压 Collector-Emitter Breakdown Voltage	I_{OH}	$I_f=8\text{ mA}, I_C=2\text{ mA}$	-	-	10	V
电阻 (输入到输出) Resistance (Input to Output)	R_{I-O}	$V_{IO} = 500\text{ Vdc}$,	-	10^{11}	-	Ω	
电容 (输入到输出) Resistance (Input to Output)	C_{I-O}	$V=0, f = 1\text{ MHz}$	-	0.8	-	pF	

 注*：电流传输比= $I_C/I_f \times 100\%$ 。

 Note*：CTR= $I_C/I_f \times 100\%$ 。

典型光电特性曲线 Typical Electro-Optical Characteristics Curves

Fig.1 Forward Current vs. Ambient Temperature

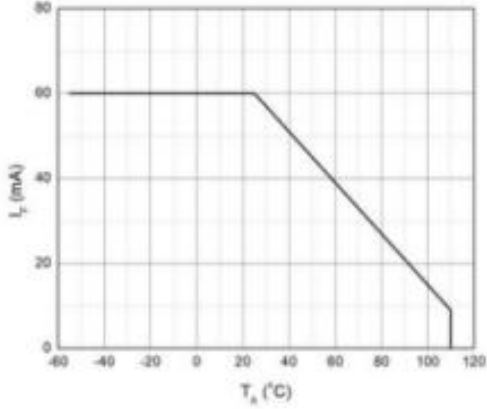

Fig.2 Collector Power Dissipation vs. Ambient Temperature

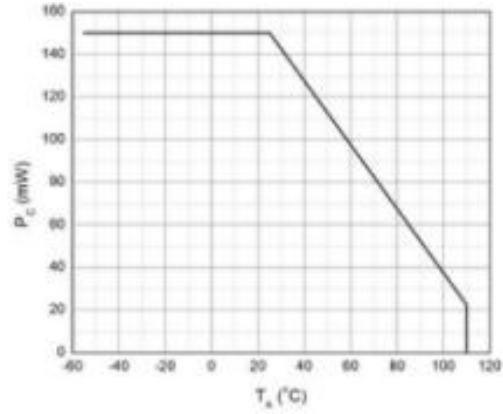

Fig.3 Forward Current vs. Forward Voltage

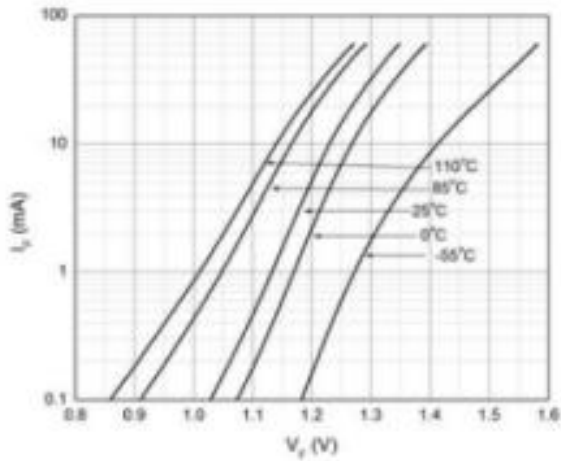

Fig.4 Collector Dark Current vs. Ambient Temperature

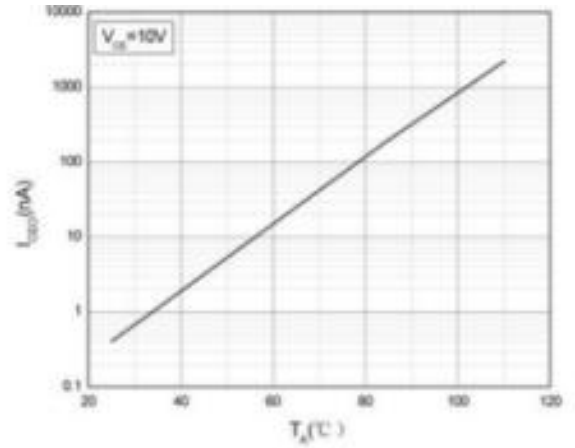

Fig.5 Collector Current vs. Collector-emitter Voltage

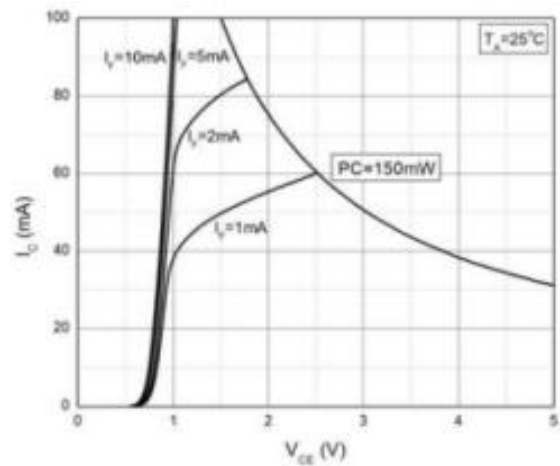
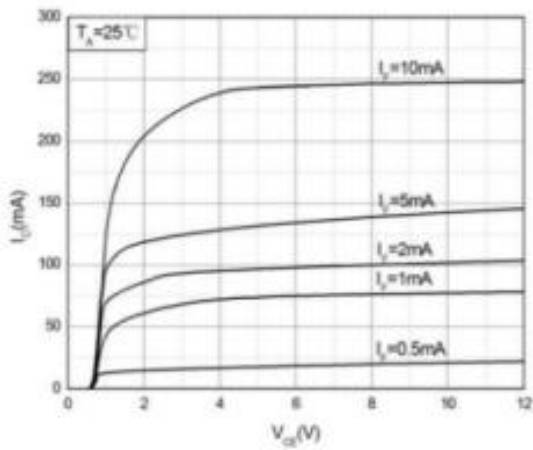

Fig.7 Normalized Current Transfer Ratio vs. Forward Current

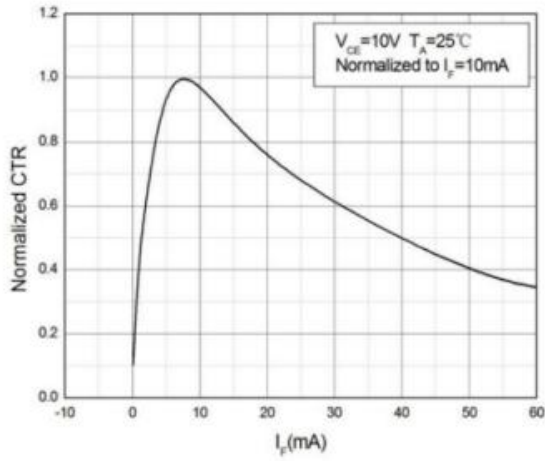

Fig.8 Normalized Current Transfer Ratio vs. Ambient Temperature

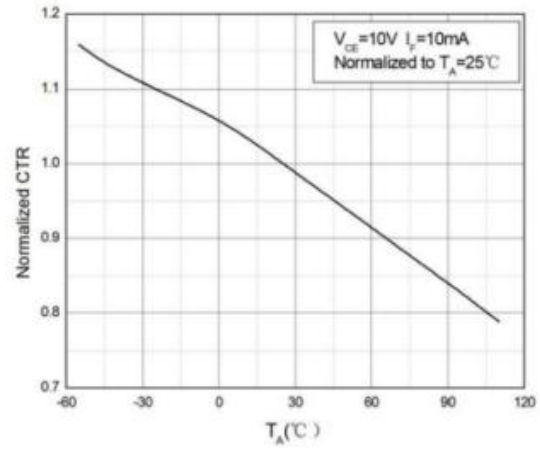

Fig.9 Collector-emitter Saturation Voltage vs. Ambient Temperature

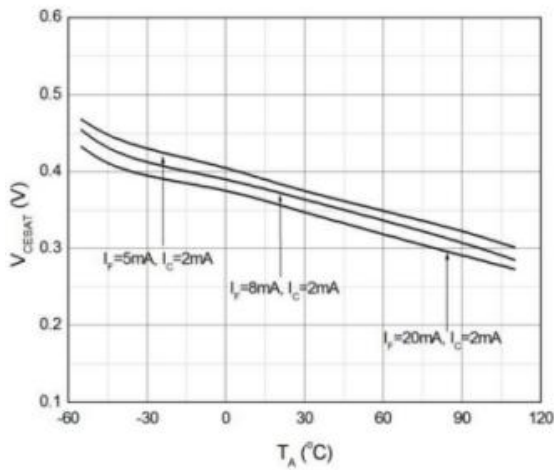
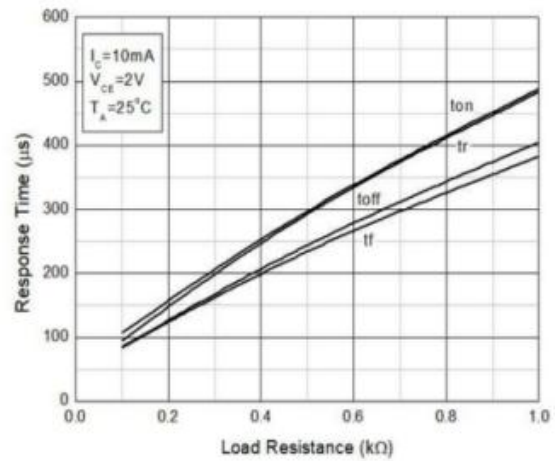

Fig.10 Switching Time vs. Load Resistance



开关时间测试电路 Witch Time Test Circuit

Fig.11 Test Circuits of Response Time

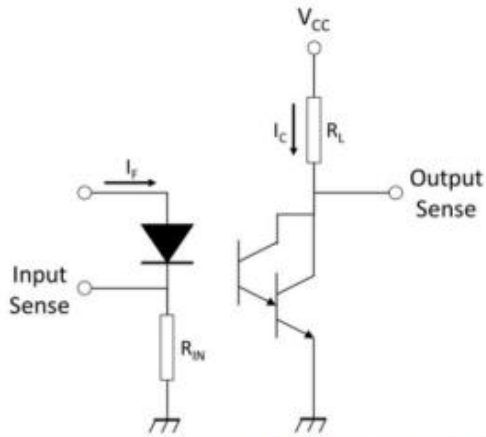

Fig.12 Curves of Response Time

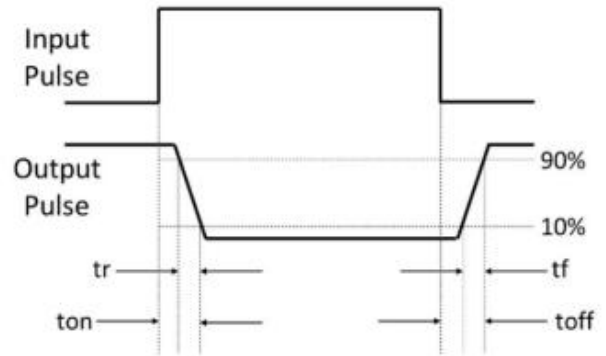
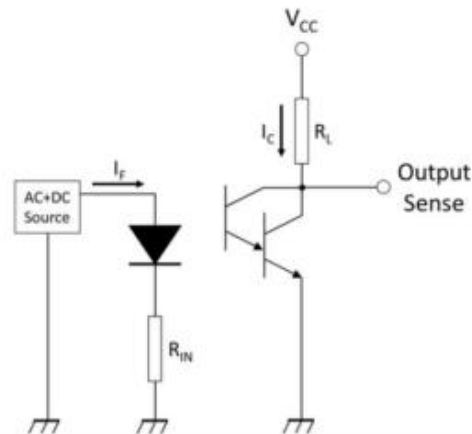
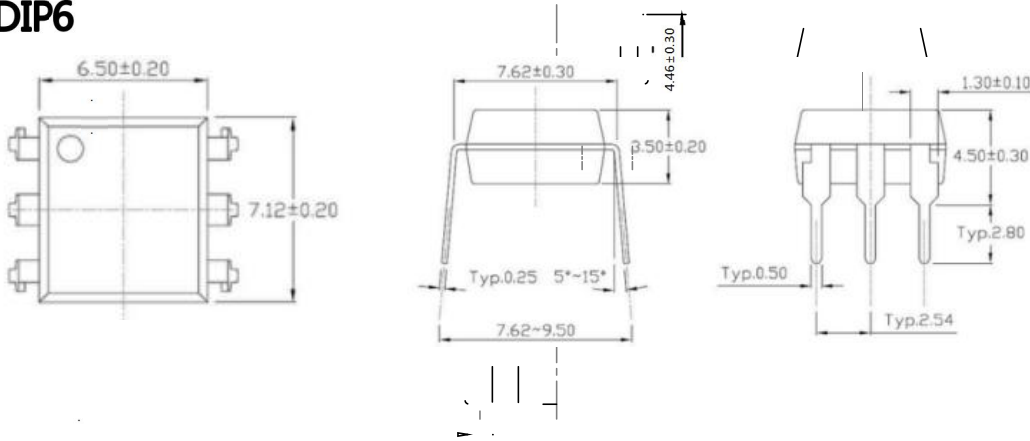

Fig.13 Test Circuits of Frequency Response



外形尺寸 Outline Dimensions

DIP6



单位 Unit: mm

SMD6

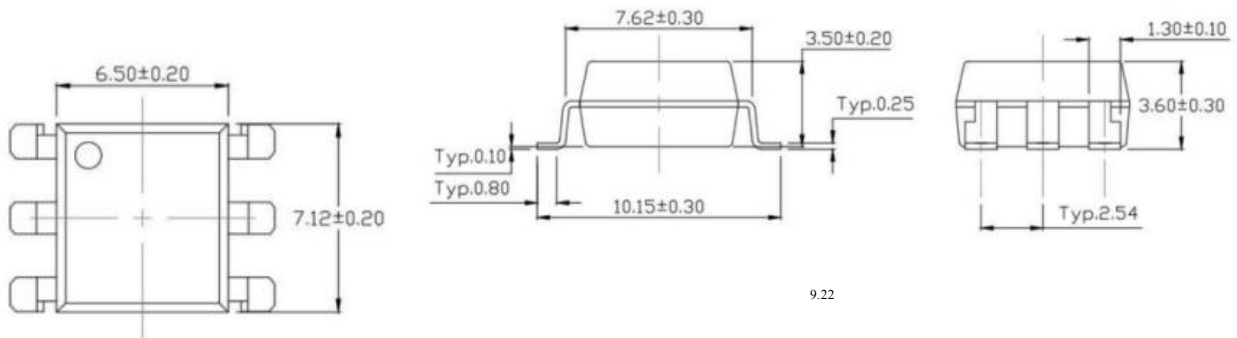

9.22

建议焊盘布局 Recommended Pad Layout

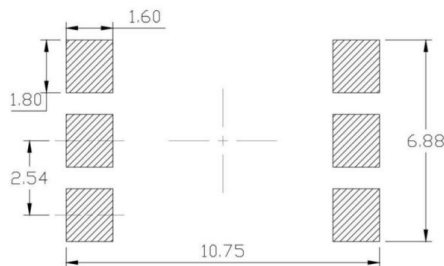

单位 Unit: mm

注：上图为产品正视图。

Note : The picture above is the front view of the product.

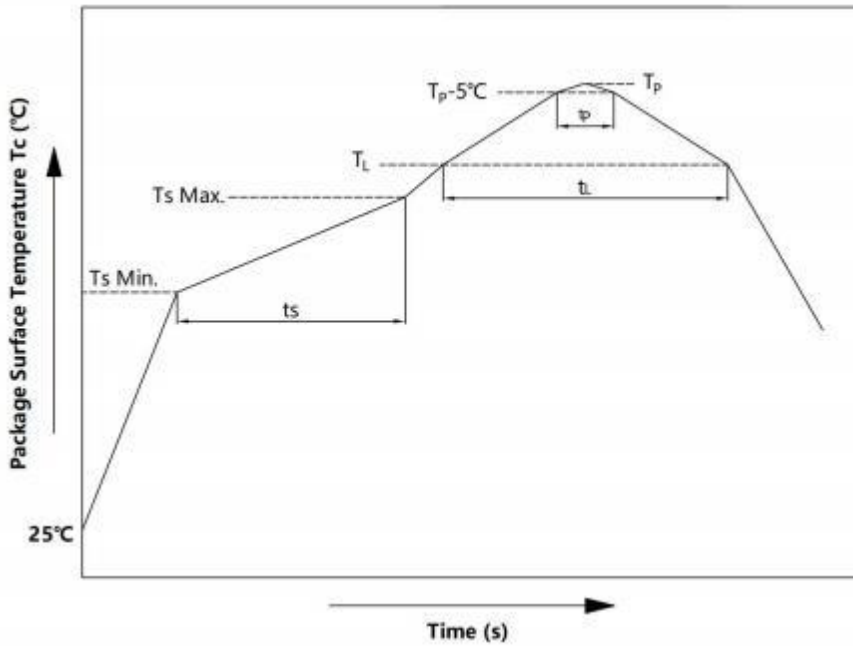
回流焊温度曲线图 Solder Reflow Profile

项目 Item	符号 Symbol	最小值 Min.	最大值 Max.	单位 Unit
预热温度 Preheat Temperature	Ts	150	200	°C
预热时间 Preheat Time	ts	60	120	s
升温速率 Ramp-Up Rate (T _L to T _P)	-	-	3	°C/s
液相线温度 Liquidus Temperature	T _L	217		°C
时间高于 T _L Time Above T _L	t _L	60	150	s
峰值温度 Peak Temperature	T _P	-	260	°C
Tc 在(T _P -5)和 T _P 之间的时间 Time During Which Tc Is Between (T _P -5) and T _P	t _p	-	30	s
降温速率 Ramp-down Rate(T _P to T _L)	-	-	6	°C/s

注 Note :

建议在所示的温度和时间条件下进行回流焊，最多不能超过三次；

Reflow soldering is recommended at the temperatures and times shown, no more than three times;

波峰焊温度曲线图 Wave Soldering Profile

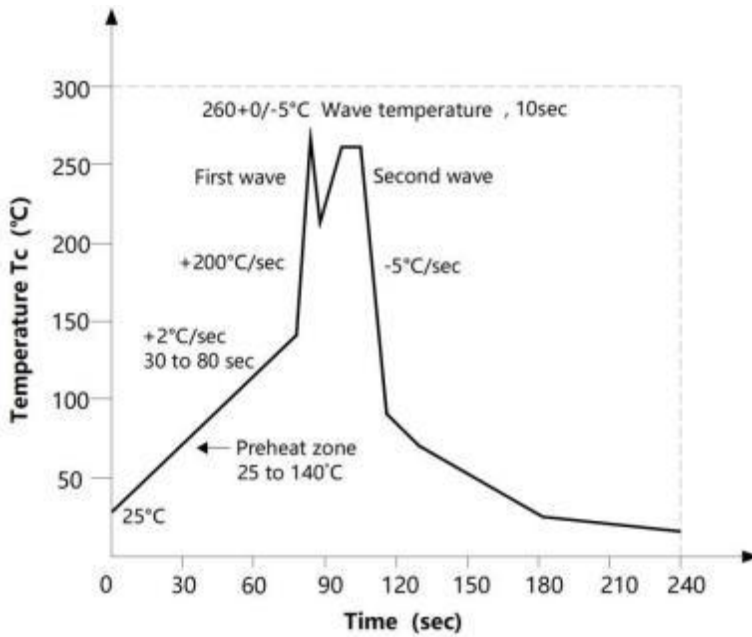

手工烙铁焊接 Soldering with hand soldering iron

- A. 手工烙铁焊仅用于产品返修或样品测试；
Hand soldering iron is only used for product rework or sample testing;
- B. 手工烙铁焊要求：温度 $360^{\circ}\text{C} \pm 5^{\circ}\text{C}$ ，时间 $\leq 3\text{s}$ 。
Hand soldering iron requirements：Temperature： $360^{\circ}\text{C} \pm 5^{\circ}\text{C}$, within 3s

包装 Packing

■ 汇总表 Summary table

封装形式	包装方式	盘数量	盒数量	箱数量	静电袋规格	盒规格	箱(双瓦楞)规格	备注
SMD6	卷盘 ($\phi 330\text{mm}$ 蓝盘)	1k/盘	2 盘/盒	10 盒/箱	450*390*0.1mm	340*60*340mm	380*360*365mm	首端空 50 个空格， 末端空 100
DIP8	管装 (500*12*11mm)	65管	50 管/盒	10 盒/箱	不适用	525*128*56mm	535*275*300mm	每管使用蓝白胶塞， 方向须一致
Package Type	Packing Form	Quantity per Reel	Quantity per Box	Quantity per Carton	Antistatic Bag Specification	Box Specification	Carton Specification	Note
SMD6	Reel ($\phi 330\text{mm}$ Blue)	1Kpcs/reel	2reels/box	10boxes /ctn	450*390*0.1mm	340*60*340mm	620*360*365 mm	Leave 50 Spaces at the beginning and 100 Spaces at the end
DIP6	Tube (500*12*11mm)	65pcs /tube	50tubes /box	10boxes /ctn	NA	525*128*56mm	535*275*300 mm	Endplug (blue) and Endplug (white) keep the direction

■ 条管包装 Tube

- 1) 每箱数量：32500 只。
Qty/ctn：32500pcs
- 2) 内包装：Inner packing：
 - i. 每条管65 只。
65pcs/tube
 - ii. 每盒 50 条管。
50 tubes/box
- 3) 示意图 Schematic：

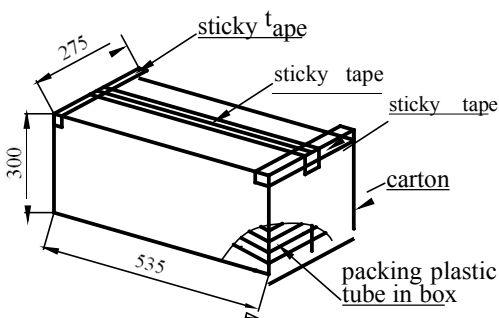

■ 编带包装 Tape & Reel

- 1) 每卷数量：1000 只。
Qty/reel：1000 pcs.
- 2) 每箱数量：20000 只。
Qty/ctn：20000 pcs.
- 3) 内包装：每盒 2 盘。
Inner packing：2 reels/box.
- 4) 示意图 Schematic：

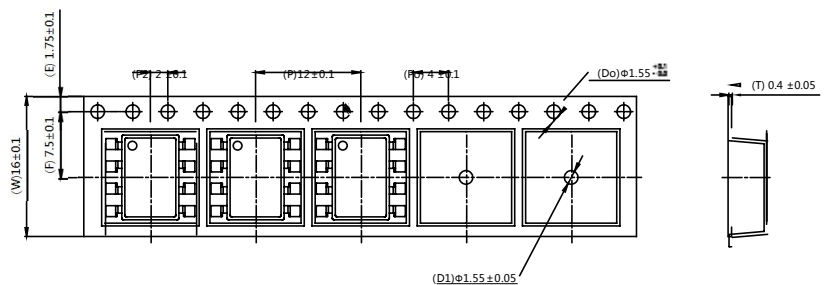

单位 Unit：mm

注意 Attention

- 奥特持续不断改进质量、可靠性、功能或设计，保留此文件更改的权利恕不另行通知。
AOTE continuously improve quality, reliability, function and design. We reserve the right to change this document without prior notice.
- 请遵守产品规格书使用，奥特不对使用时不符合产品规格书条件而导致的质量问题负责。
Please use in accordance with the product specification. AOTE is not responsible for the quality problems caused by non-compliance with the product specifications.
- 对于需要高可靠性或安全性的设备/装置需求，请联系我们的销售人员。
For equipment/devices requiring high reliability or safety, please contact our sales representatives.
- 当需要用于任何“特定”应用时，请咨询我们的销售人员。
When requiring a device for any “specific” application, please contact our sales in advice.
- 如对文件中表述的内容有疑问，欢迎联系我们。
If you have any questions about the contents of the document, please contact us.

X-ON Electronics

Largest Supplier of Electrical and Electronic Components

Click to view similar products for [Transistor Output Optocouplers](#) category:

Click to view products by [AOTE](#) manufacturer:

Other Similar products are found below :

[LTV-814S-TA](#) [LTV-852S](#) [66095-001](#) [PS2561-1-A](#) [PS2561A-1-W-A](#) [PS2561L1-1-A](#) [PS2561L-1-V-A](#) [PS2706-1-A](#) [PS2815-1-A](#) [MRF658](#)
[ELD207\(TA\)](#) [ILD2-X006](#) [ILQ615-3X016](#) [LDA102S](#) [SFH615A-4XSM TR](#) [PS2561DL-1Y-F3-A](#) [PS2561L1-1-L-A](#) [PS2562-1-V-A](#) [PS2565L-](#)
[1-A](#) [PS2581L2-A](#) [PS2701A-1-F3-P-A](#) [PS2711-1-A](#) [PS2801-1-F3-P-A](#) [PS2833-4-A](#) [PS2841-4A-AX](#) [LTV-702FS](#) [LTV-702V](#) [LTV-702VB](#)
[LTV-816S-TA](#) [TCET2100](#) [TLP290-4\(E\(T](#) [IL215AT](#) [WPPC-A11066AA](#) [WPPC-A11066AD](#) [WPPC-A11084ASS](#) [WPPC-A21068AA](#) [WPPC-](#)
[D11066AA](#) [WPPC-D21068ED](#) [WPPC-D410616EA](#) [WPPC-D410616ED](#) [X4IAC24A](#) [4N26-X001](#) [EL1010\(TA\)-VG](#) [SFH600-2X007](#)
[TCMT1118](#) [VO206AT](#) [WPPC-D21068EA](#) [WPPC-D11064AD](#) [WPPC-A410616AD](#) [WPPC-A21068AD](#)