



# 晶体管光耦 Photo Transistor

## AT817X

Product Data Sheet

**AOTE DCC**  
**RELEASE**

**台湾奥特半导体科技有限公司**

TAIWAN AOTE SEMICONDUCTOR TECHNOLOGY CO.,LTD

[www.aotesemi.com](http://www.aotesemi.com)

## 概述 Description

AT817X是一款由发光二极管和光电晶体管组成的光电耦合器。 四引脚封装， 三种形式（DIP、DIP-M、SMD）。  
The AT817X is a photoelectric coupler composed of light-emitting diode and phototransistor. It is packaged in a 4-pin package at DIP、DIP-M、SMD.

## 特性 Features

- 电流转换比(CTR)范围: 80%-600% ( $I_F = 5\text{mA}$ ,  $V_{CE} = 5\text{V}$ ,  $T_a = 25^\circ\text{C}$ )  
Current transfer ratio: 80%-600% ( $I_F = 5\text{mA}$ ,  $V_{CE} = 5\text{V}$ ,  $T_a = 25^\circ\text{C}$ )
- 输入-输出隔离电压 ( $V_{ISO} = 5000\text{ Vrms}$ )  
High isolation voltage between input and output ( $V_{ISO} = 5000\text{ Vrms}$ )
- 集电极-发射极击穿电压  $BV_{CEO} \geq 80\text{V}$   
Collector - emitter breakdown voltage  $BV_{CEO} \geq 80\text{V}$
- 工作温度:  $-55^\circ\text{C} \sim 110^\circ\text{C}$   
Operating Temperature:  $-55^\circ\text{C} \sim 110^\circ\text{C}$
- 符合加强绝缘标准  
Meet reinforced insulation standards
- 符合安规标准: UL 1577, VDE DIN EN60747-5-5 (VDE 0884-5), CQC11-471543-2022  
Meet safety standard approval: UL 1577, VDE DIN EN60747-5-5 (VDE 0884-5), CQC11-471543-2022

## 应用 Applications

- 开关电源, 智能电表  
Switching power supply, intelligent meter
- 工业控制, 测量仪器  
Industrial control, measuring instruments
- 办公设备, 比如复印机  
Office equipment such as copiers
- 家用电器, 比如空调、风扇、热水器等  
Household appliances: such as air conditioners, fans, water heaters, etc.

## 封装和原理图 Package and Schematic Diagram

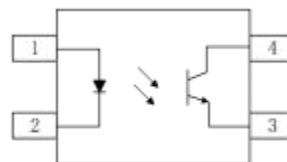

Pin Configuration

1. Anode
2. Cathode
3. Emitter
4. Collector



## 产品型号命名规则 Order Code

# AT 817 X - UN Y - W (V) (ZZ)

①      ②      ③      ④      ⑤      ⑥      ⑦      ⑧

- ① 公司代码 Company Code (AT: 奥特 Aote)
- ② 产品系列 Product Series (817: 817)
- ③ CTR 档位 Classification (代码 Code: A、 B、 C、 D or None)
- ④ 框架类型 Lead Frame (Cu: 铜框架 Copper, Fe: 铁框架 Ferrum)
- ⑤ 树脂类型 Epoxy Type (H: 无卤 Halogen-free)
- ⑥ 封装形式 Package (D:DIP, S:SMD, M:DIP-M)
- ⑦ 器件工作温度范围 Device Operating Temperature Range (特殊范围需填或者空白 Special Range need to be filled in or left blank)
- ⑧ 内部补充代码 Internal Supplementary Code (数字或者空白 Number or None)

## 印字信息 Marking Information

- 印字中 “” 为奥特品牌 LOGO  
“” denotes LOGO
- 印字中的 “X” 代表产品分档：A、 B、 C、 D 或空白  
“X” denotes the classification：A、 B、 C、 D or None
- 印字中 “Y” 代表年份； A(2018),B(2019),C(2020) ... ..  
“Y” denotes YEAR： A(2018), B(2019), C(2020) ... ..
- 印字中 “WW” 代表周号  
“WW” denotes Week’s number
- 印字中 “N” 代表星期几  
“N” denotes day of the week
- 印字中的 “H” 代表无卤  
“H” denotes Halogen-free



**绝缘和安规信息 Insulation and Safety related specifications**

项目 Item	符号 Symbol	数值 Value	单位 Unit	备注 Remark
爬电距离 Creepage Distance	L	>7.0	mm	从输入端到输出端，沿本体最短距离路径 Measured from input terminals to output terminals, shortest distance path along body
电气间隙 Clearance Distance	L	>7.0	mm	从输入端到输出端，通过空气的最短距离 Measured from input terminals to output terminals, shortest distance through air
绝缘距离 Insulation Thickness	DTI	>0.4	mm	发射器和探测器之间的绝缘厚度 Insulation thickness between emitter and detector
峰值隔离电压 Peak Isolation Voltage	V <sub>IORM</sub>	1500	V <sub>peak</sub>	DIN/EN/IEC EN60747-5-5
瞬态隔离电压 Transient isolation voltage	V <sub>IOTM</sub>	7000	V <sub>peak</sub>	DIN/EN/IEC EN60747-5-5
隔离电压 Isolation Voltage	V <sub>iso</sub>	>5000	V <sub>rms</sub>	For 1 min, RH < 60%

**极限参数 Absolute Maximum Ratings (Ta = 25°C)**

参数 Parameter		符号 Symbol	额定值 Rating	单位 Unit
发射端 Input	正向电流 Forward Current	I <sub>F</sub>	50	mA
	峰值正向电流(1us, 脉冲) Peak forward current (1us, pulse)	I <sub>FP</sub>	1000	mA
	反向电压 Reverse Voltage	V <sub>R</sub>	6	V
	功耗 Power Dissipation	P <sub>D</sub>	70	mW
接收端 output	集电极功耗 Collector Power Dissipation	P <sub>C</sub>	150	mW
	集电极电流 Collector Current	I <sub>C</sub>	50	mA
	集电极-发射极电压 Collector-Emitter Voltage	V <sub>CEO</sub>	80	V
	发射极-集电极电压 Emitter - Collector Voltage	V <sub>EEO</sub>	6	V
工作温度 Operating Temperature	T <sub>opr</sub>	-55 ~ +110	°C	
存储温度 Storage Temperature	T <sub>stg</sub>	-55 ~ +125	°C	
焊接温度 Soldering Temperature	T <sub>sol</sub>	260	°C	

**产品特性参数 Electro-optical Characteristics (Ta = 25°C)**

参数 Parameter		符号 Symbol	条件 Condition	最小 Min.	典型 Typ.	最大 Max.	单位 Unit
发射端 Input	正向电压 Forward Voltage	$V_F$	$I_F = 20\text{mA}$	-	1.2	1.4	V
	反向电流 Reverse Current	$I_R$	$V_R = 4\text{V}$	-	-	10	$\mu\text{A}$
	输入电容 Terminal Capacitance	$C_t$	$V=0, F=1\text{kHz}$	-	30	250	pF
接收端 Output	集电极暗电流 Collector Dark Current	$I_{CEO}$	$V_{CE} = 20\text{V}$	-	-	100	nA
	集电极-发射极击穿电压 Collector-Emitter Breakdown Voltage	$BV_{CEO}$	$I_C = 0.1\text{mA}, I_F = 0$	80	-	-	V
	发射极-集电极击穿电压 Emitter-Collector Breakdown Voltage	$BV_{ECO}$	$I_E = 10\mu\text{A}, I_F = 0$	6	-	-	V
传输特性 Transfer Characteristics	电流传输比 Current Transfer Ratio	CTR*	$I_F = 5\text{mA}, V_{CE} = 5\text{V}$	80	-	600	%
	集电极-发射极饱和压降 Collector-Emitter Saturation Voltage	$V_{CE(sat)}$	$I_F = 20\text{mA}, I_C = 1\text{mA}$	-	0.1	0.2	V
	隔离电阻 Isolation Resistance	$R_{ISO}$	$V_{I-O} = \text{DC}500\text{V}$ 40 ~ 60%R.H.	$1 \times 10^{12}$	-	-	$\Omega$
	隔离电容 Isolation capacitance	$C_{ISO}$	$V=0, F=1\text{MHz}$	-	0.6	1.0	pF
	截至频率 Cut-off Frequency	$F_C$	$V_{CE} = 5\text{V}, I_C = 2\text{mA},$ $R_L = 100\Omega, -3\text{dB}$	-	80	-	KHz
	上升时间 Rise Time	$T_r$	$V_{CE} = 2\text{V}, I_C = 2\text{mA}$ $R_L = 100\Omega$	-	4	18	$\mu\text{s}$
下降时间 Fall Time	$T_f$	$V_{CE} = 2\text{V}, I_C = 2\text{mA},$ $R_L = 100\Omega$	-	3	18	$\mu\text{s}$	

注\*：电流传输比= $I_C/I_F \times 100\%$ 。

Note\*：CTR= $I_C/I_F \times 100\%$ 。

**电流传输比分档表 CTR Classification Table ( $I_F = 1\text{mA}, V_{CE} = 5\text{V}, T_a = 25^\circ\text{C}$ )**

代码 Code	最小值 Min.	最大值 Max.
None	80	600
A	80	160
B	130	260
C	200	400
D	300	600

**典型光电特性曲线 Typical Electro-Optical Characteristics Curves**

Fig.1 Allowable Forward Current VS Ambient Temperature

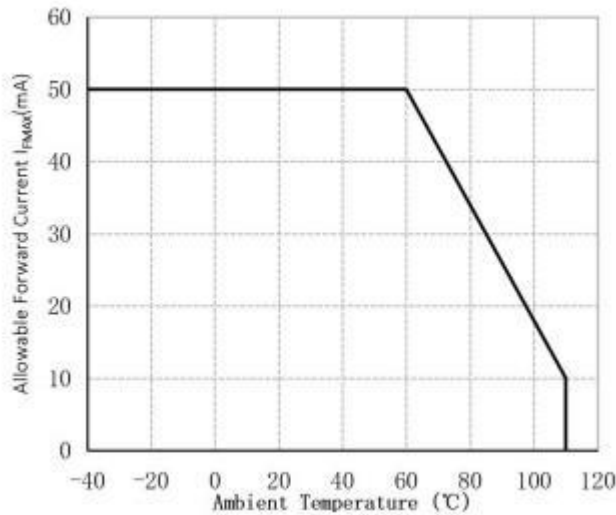

Fig.2 Allowable collector power dissipation VS Ambient Temperature(°C)

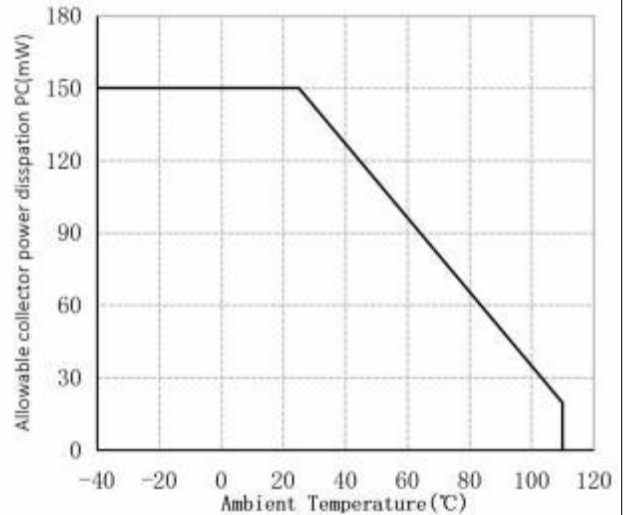

Fig.3 Relative Current Transfer Ratio vs. Forward Current

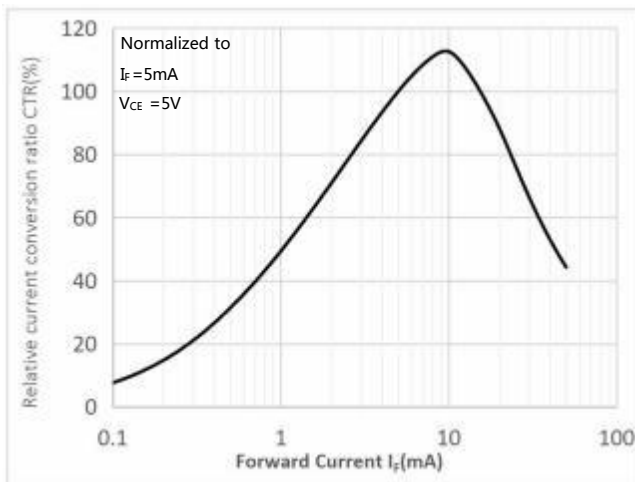

Fig.4 Forward Current vs. Forward Voltage

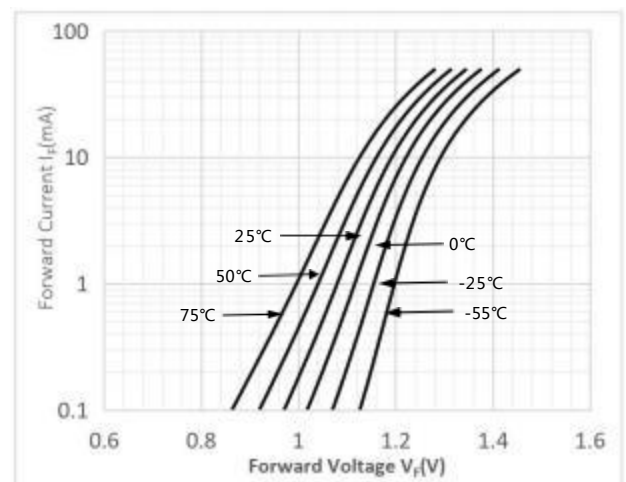

Fig.5 Collector Current vs. Collector-emitter Voltage

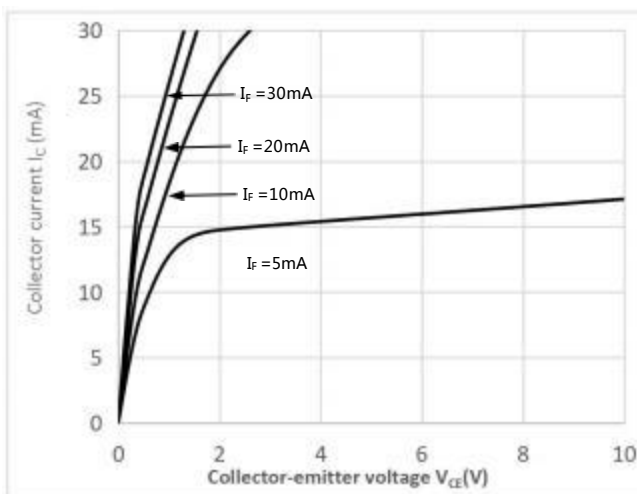

Fig.6 Relative Current Transfer Ratio vs. Ambient Temperature

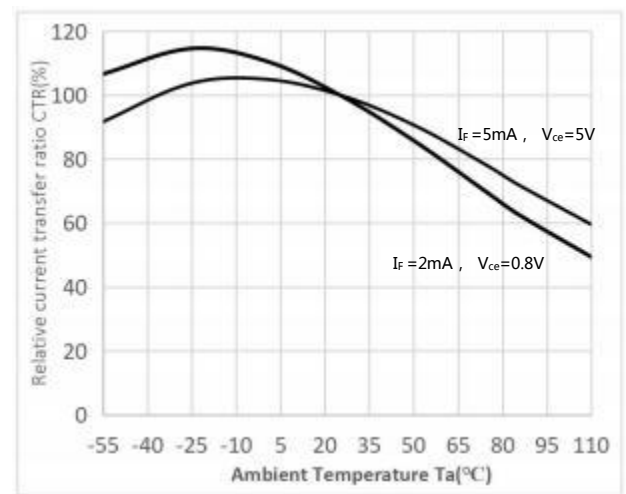

Fig.7 Collector-emitter Saturation Voltage vs. Ambient Temperature

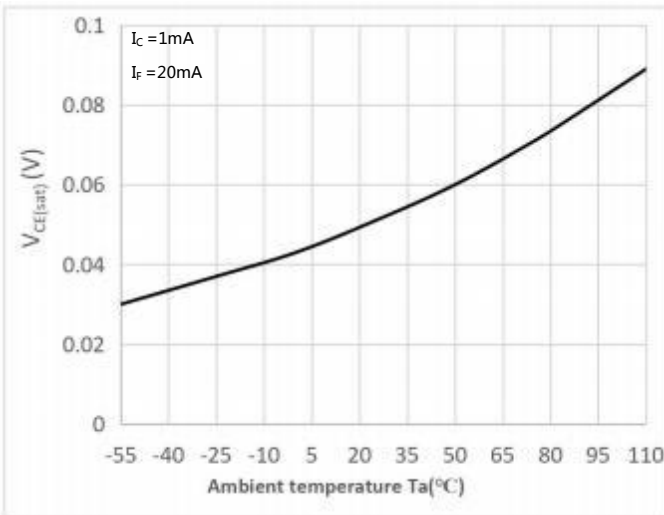

Fig.8 Collector Dark Current vs Ambient Temperature

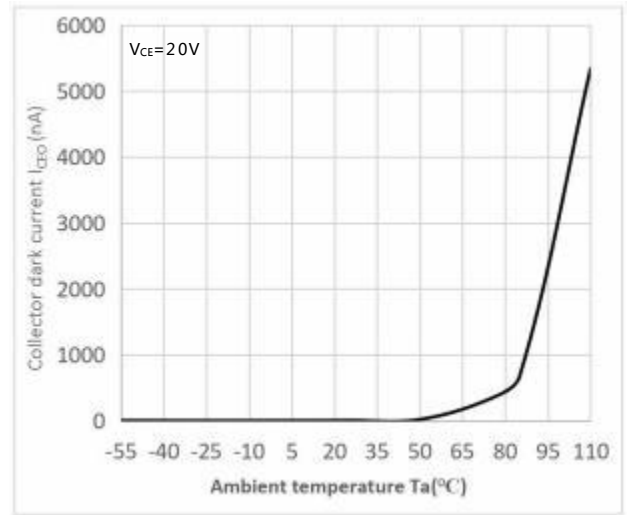

Fig.9 Response Time vs. Load Resistance

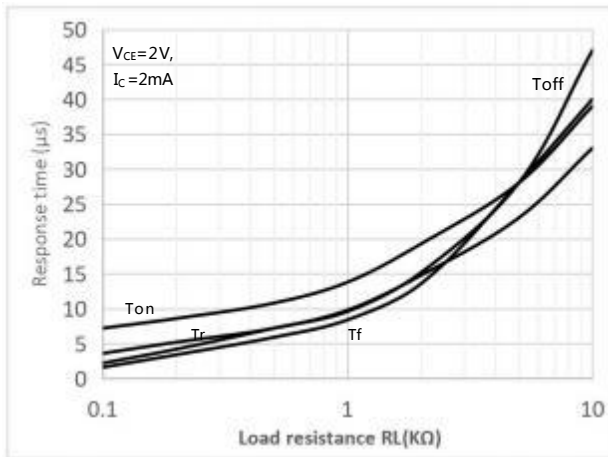

Fig.10 Frequency Response

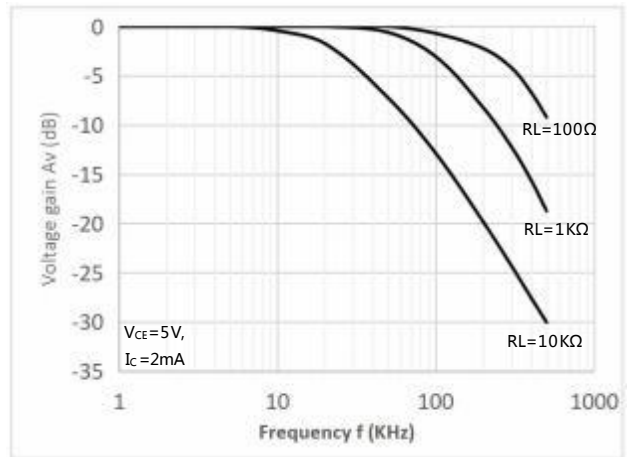

Fig.11 Collector-emitter Saturation Voltage vs Forward Current

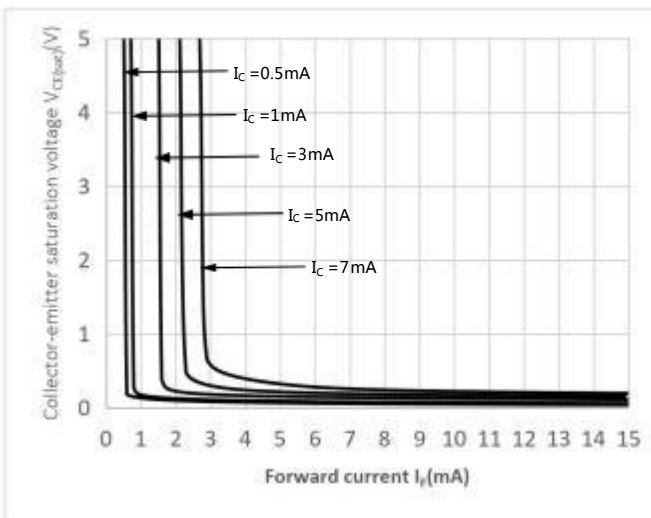
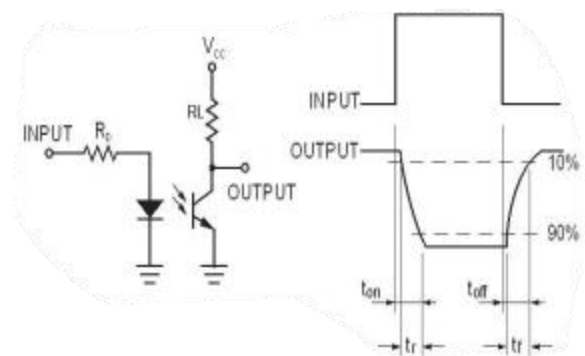
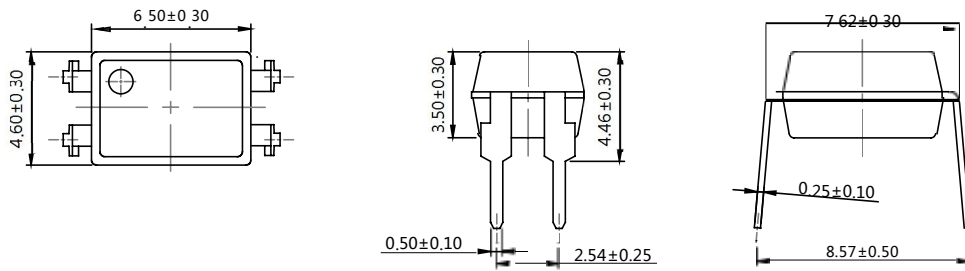

Fig.12 Switching Time Test Circuit & Waveforms



## 外形尺寸 Outline Dimensions

DIP4



DIP4-M

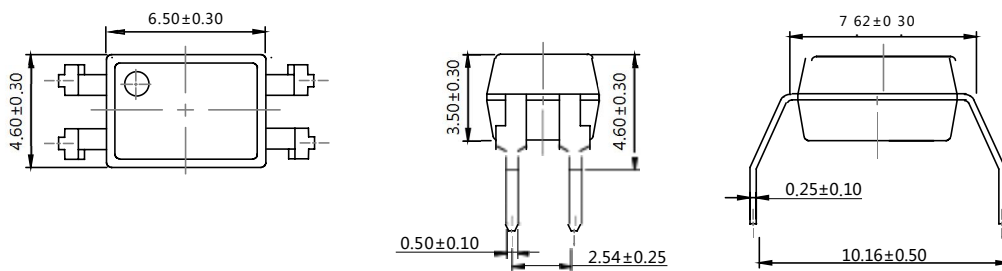

SMD

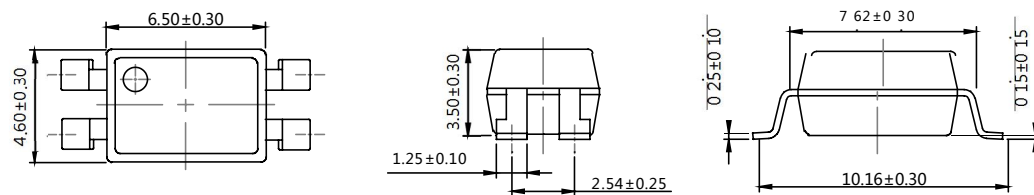

单位 Unit: mm

## 建议焊盘布局 Recommended Pad Layout

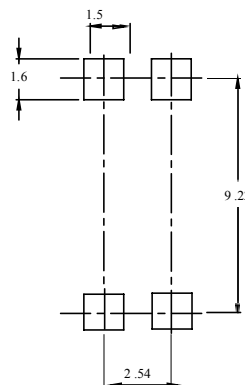

单位 Unit: mm

注：上图为产品正视图。

Note: The picture above is the front view of the product.

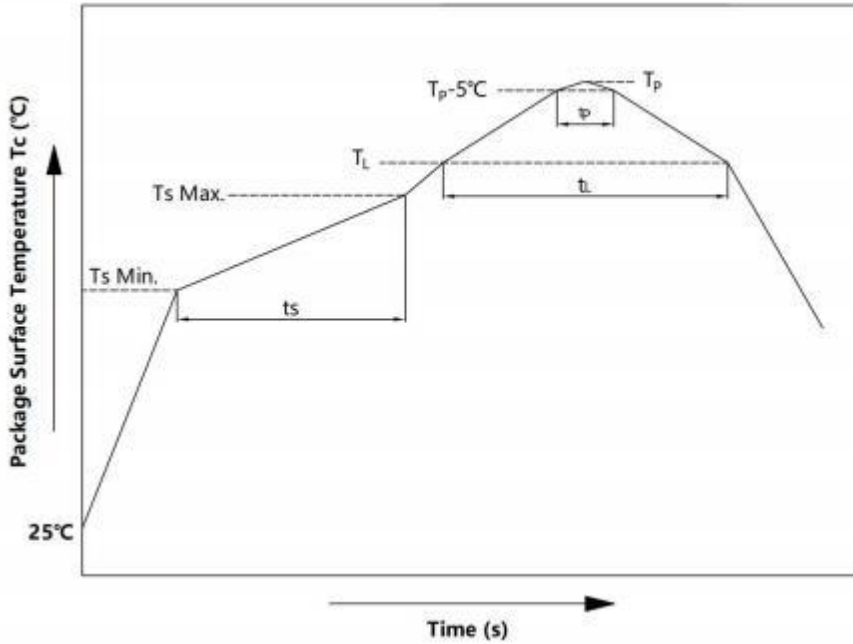

**回流焊温度曲线图 Solder Reflow Profile**

项目 Item	符号 Symbol	最小值 Min.	最大值 Max.	单位 Unit
预热温度 Preheat Temperature	$T_s$	150	200	$^\circ\text{C}$
预热时间 Preheat Time	$t_s$	60	120	s
升温速率 Ramp-Up Rate ( $T_L$ to $T_P$ )	-	-	3	$^\circ\text{C/s}$
液相线温度 Liquidus Temperature	$T_L$	217		$^\circ\text{C}$
时间高于 $T_L$ Time Above $T_L$	$t_L$	60	150	s
峰值温度 Peak Temperature	$T_P$	-	260	$^\circ\text{C}$
$T_c$ 在 $(T_P - 5)$ 和 $T_P$ 之间的时间 Time During Which $T_c$ Is Between $(T_P - 5)$ and $T_P$	$t_p$	-	30	s
降温速率 Ramp-down Rate ( $T_P$ to $T_L$ )	-	-	6	$^\circ\text{C/s}$

注 Note :

建议在所示的温度和时间条件下进行回流焊，最多不能超过三次；

Reflow soldering is recommended at the temperatures and times shown, no more than three times;

## 波峰焊温度曲线图 Wave Soldering Profile

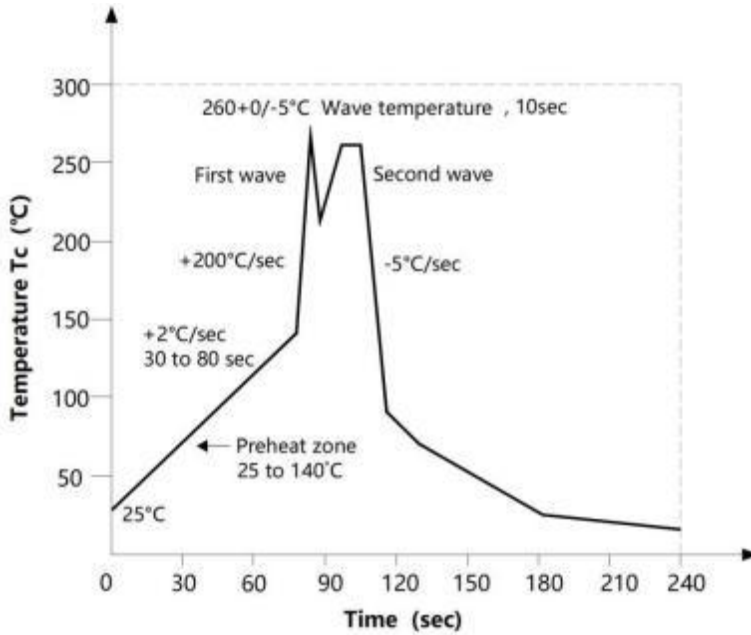

## 手工烙铁焊接 Soldering with hand soldering iron

- A. 手工烙铁焊仅用于产品返修或样品测试；  
Hand soldering iron is only used for product rework or sample testing;
- B. 手工烙铁焊要求：温度  $360^{\circ}\text{C} \pm 5^{\circ}\text{C}$ ，时间  $\leq 3\text{s}$ 。  
Hand soldering iron requirements：Temperature：  $360^{\circ}\text{C} \pm 5^{\circ}\text{C}$ , within 3s.

## 包装 Packing

### ■ 汇总表 Summary table

封装形式	包装方式	盘数量	盒数量	箱数量	静电袋规格	盒规格	箱(双瓦楞)规格	备注
SMD4	卷盘 ( $\phi 330$ mm 蓝盘)	2000 只/盘	2 盘/盒	10 盒/箱	450*390*0.1mm	340*60*340mm	620*360*365mm	首尾端空至少 200mm
DIP4	管装 (500*12*11mm)	100 只/管	50 管/盒	10 盒/箱	不适用	525*128*56mm	535*275*300mm	每管使用蓝白胶塞, 方向须一致
DIP4-M	管装 (500*13*11mm)	100 只/管	50 管/盒	10 盒/箱	不适用	525*136*58mm	535*295*310mm	
Package Type	Packing Form	Quantity per Reel	Quantity per Box	Quantity per Carton	Antistatic Bag Specification	Box Specification	Carton Specification	Note
SMD4	Reel ( $\phi 330$ mm Blue)	2000 pcs/reel	2 reels/box	10 boxes/ctn	450*390*0.1mm	340*60*340mm	620*360*365mm	Guard band 200mm min.
DIP4	Tube (500*12*11mm)	100 pcs /tube	50 tubes/box	10 boxes/ctn	NA	525*128*56mm	535*275*300mm	Endplug (blue) and Endplug (white) keep the direction
DIP4-M	Tube (500*13*11mm)	100 pcs /tube	50 tubes/box	10 boxes/ctn	NA	525*136*58mm	535*295*310mm	

### ■ 编带包装 Tape & Reel

- 1) 每卷数量：2000 只。  
Qty/reel：2000 pcs.
- 2) 每箱数量：40000 只。  
Qty/ctn：40000 pcs.
- 3) 内包装：每盒 2 盘。  
Inner packing：2 reels/box.
- 4) 示意图 Schematic：

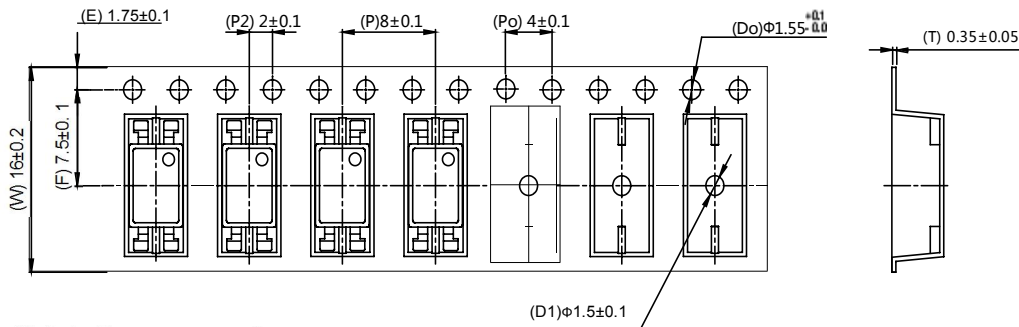

### ■ 管条包装 Tape & Tube

- 1) 每管数量：100 只。  
Qty/Tube：100 pcs.
- 2) 每箱数量：50000 只。  
Qty/ctn：50000 pcs.
- 3) 内包装：每盒 50 管。  
Inner packing：50 Tube/box.
- 4) 示意图 Schematic：

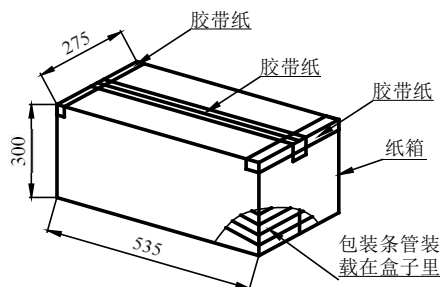

单位/Unit：mm

## 注意 Attention

- 奥特持续不断改进质量、可靠性、功能或设计，保留此文件更改的权利恕不另行通知。  
AOTE continuously improve quality, reliability, function and design. We reserve the right to change this document without prior notice.
- 请遵守产品规格书使用，奥特不对使用时不符合产品规格书条件而导致的质量问题负责。  
Please use in accordance with the product specification. AOTE is not responsible for the quality problems caused by non-compliance with the product specifications.
- 对于需要高可靠性或安全性的设备/装置需求，请联系我们的销售人员。  
For equipment/devices requiring high reliability or safety, please contact our sales representatives.
- 当需要用于任何“特定”应用时，请咨询我们的销售人员。  
When requiring a device for any “specific” application, please contact our sales in advice.
- 如对文件中表述的内容有疑问，欢迎联系我们。  
If you have any questions about the contents of the document, please contact us.

## X-ON Electronics

Largest Supplier of Electrical and Electronic Components

*Click to view similar products for [Transistor Output Optocouplers](#) category:*

*Click to view products by [AOTE](#) manufacturer:*

Other Similar products are found below :

[LTV-814S-TA](#) [LTV-852S](#) [66095-001](#) [PS2561-1-A](#) [PS2561A-1-W-A](#) [PS2561L1-1-A](#) [PS2561L-1-V-A](#) [PS2706-1-A](#) [PS2815-1-A](#) [MRF658](#)  
[ELD207\(TA\)](#) [ILD2-X006](#) [ILQ615-3X016](#) [LDA102S](#) [SFH615A-4XSM TR](#) [PS2561DL-1Y-F3-A](#) [PS2561L1-1-L-A](#) [PS2562-1-V-A](#) [PS2565L-](#)  
[1-A](#) [PS2581L2-A](#) [PS2701A-1-F3-P-A](#) [PS2711-1-A](#) [PS2801-1-F3-P-A](#) [PS2833-4-A](#) [PS2841-4A-AX](#) [LTV-702FS](#) [LTV-702V](#) [LTV-702VB](#)  
[LTV-816S-TA](#) [TCET2100](#) [TLP290-4\(E\(T](#) [IL215AT](#) [WPPC-A11066AA](#) [WPPC-A11066AD](#) [WPPC-A11084ASS](#) [WPPC-A21068AA](#) [WPPC-](#)  
[D11066AA](#) [WPPC-D21068ED](#) [WPPC-D410616EA](#) [WPPC-D410616ED](#) [X4IAC24A](#) [4N26-X001](#) [EL1010\(TA\)-VG](#) [SFH600-2X007](#)  
[TCMT1118](#) [VO206AT](#) [WPPC-D21068EA](#) [WPPC-D11064AD](#) [WPPC-A410616AD](#) [WPPC-A21068AD](#)