



晶体管光耦 Photo Transistor

AT827

Product Data Sheet

AOTE DCC
RELEASE

台湾奥特半导体科技有限公司

TAIWAN AOTE SEMICONDUCTOR TECHNOLOGY CO.,LTD

www.aotesemi.com

概述 Description

AT827是一款由发光二极管和光电晶体管组成的双通道光电耦合器。八引脚封装，两种形式（DIP、SMD）。
The AT827 is a dual channel photocoupler composed of light emitting diodes and phototransistors. It is packaged in a 8-pin package of two forms such as DIP、SMD.

特性 Features

- 电流转换比(CTR)范围: 80% ~600% ($I_f = 5\text{mA}$, $V_{CE} = 5\text{V}$, $T_a = 25^\circ\text{C}$)
Current transfer ratio: 80% ~600% ($I_f = 5\text{mA}$, $V_{CE} = 5\text{V}$, $T_a = 25^\circ\text{C}$)
- 输入-输出隔离电压 ($V_{ISO} = 5000 \text{ Vrms}$)
High isolation voltage between input and output ($V_{ISO} = 5000 \text{ Vrms}$)
- 集电极-发射极击穿电压 $BV_{CEO} \geq 80\text{V}$
Collector - emitter breakdown voltage $BV_{CEO} \geq 80\text{V}$
- 工作温度: $-55^\circ\text{C} \sim 110^\circ\text{C}$
Operating Temperature: $-55^\circ\text{C} \sim 110^\circ\text{C}$
- 符合加强绝缘标准
Meet reinforced insulation standards
- 符合安规标准: UL 1577, VDE DIN EN60747-5-5 (VDE 0884-5), CQC11-471543-2022
Meet safety standard approval: UL 1577, VDE DIN EN60747-5-5 (VDE 0884-5), CQC11-471543-2022

应用 Applications

- 开关电源, 智能电表
Switching power supply, intelligent meter
- 工业控制, 测量仪器
Industrial control, measuring instruments
- 办公设备, 比如复印机
Office equipment such as copiers
- 家用电器, 比如空调、风扇、热水器等
Household appliances: such as air conditioners, fans, water heaters, etc.

封装和原理图 Package and Schematic Diagram



SMD-8



DIP-8

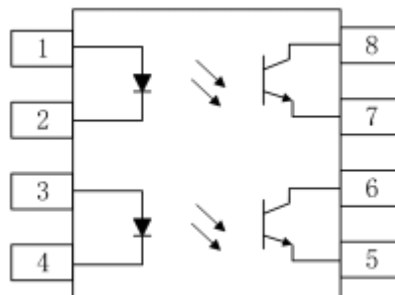

Pin Configuration

- 1. Anode
- 2. Cathode
- 7. Emitter
- 8. Collector



产品型号命名规则 Order Code

AT 827 - UN Y - W (V) (ZZ)

① ② ③ ④ ⑤ ⑥ ⑦

- ① 公司代码 Company Code (AT: 奥特 Aote)
- ② 产品系列 Product Series (827: 827)
- ③ 框架类型 Lead Frame (Cu: 铜框架 Copper, Fe: 铁框架 Ferrum)
- ④ 树脂类型 Epoxy Type (H: 无卤 Halogen-free)
- ⑤ 封装形式 Package (D:DIP, S:SMD)
- ⑥ 器件工作温度范围 Device Operating Temperature Range (特殊范围需填或者空白 Special Range need to be filled in or left blank)
- ⑦ 内部补充代码 Internal Supplementary Code (数字或者空白 Number or None)

印字信息 Marking Information

- 印字中 “” 为奥特品牌 LOGO
“” denotes LOGO
- 印字中的 “X” 代表产品分档：A、B、C、D 或空白
“X” denotes the classification：A、B、C、D or None
- 印字中 “Y” 代表年份；A(2018),B(2019),C(2020)
“Y” denotes YEAR：A(2018), B(2019), C(2020)
- 印字中 “WW” 代表周号
“WW” denotes Week’ s number
- 印字中 “E” 代表内部代码
“E” denotes Internal code
- 印字中的 “H” 代表无卤
“H” denotes Halogen-free



绝缘和安规信息 Insulation and Safety related specifications

| 项目 Item | 符号 Symbol | 数值 Value | 单位 Unit | 备注 Remark |
|---------------------------------------|--------------|-------------|------------|--|
| 爬电距离 Creepage Distance | L | > 7.0 | mm | 从输入端到输出端，沿本体最短距离路径 Measured from input terminals to output terminals, shortest distance path along body |
| 电气间隙 Clearance Distance | L | > 7.0 | mm | 从输入端到输出端，通过空气的最短距离 Measured from input terminals to output terminals, shortest distance through air |
| 绝缘距离 Insulation Thickness | DTI | > 0.4 | mm | 发射器和探测器之间的绝缘厚度 Insulation thickness between emitter and detector |
| 峰值隔离电压 Peak Isolation Voltage | V_{IORM} | 1500 | V_{peak} | DIN/EN/IEC EN60747-5-5 |
| 瞬态隔离电压 Transient isolation voltage | V_{IOTM} | 7000 | V_{peak} | DIN/EN/IEC EN60747-5-5 |
| 隔离电压 Isolation Voltage | V_{iso} | > 5000 | V_{rms} | For 1 min, RH < 60% |

极限参数 Absolute Maximum Ratings (Ta = 25°C)

| 参数 Parameter | | 符号 Symbol | 额定值 Rating | 单位 Unit |
|--------------------------------|--|--------------|---------------|------------|
| 发射端 Input | 正向电流 Forward Current | I_F | 60 | mA |
| | 反向电压 Reverse Voltage | V_R | 6 | V |
| | 功耗 Power Dissipation | P_D | 70 | mW |
| | 额定值降低因子(在 Ta = 100°C 以上) Power dissipation Derating factor (above Ta = 100°C) | P_{DD} | 2.0 | mW/°C |
| | 热阻(结-环境) Thermal Resistance Junction-Ambient | R_{thJ-A} | 325 | °C/W |
| | 热阻(结-壳) Thermal Resistance Junction-Case | R_{thJ-C} | 200 | °C/W |
| 接收端 output | 集电极功耗 Collector Power Dissipation | P_C | 150 | mW |
| | 集电极电流 Collector Current | I_C | 50 | mA |
| | 集电极-发射极电压 Collector-Emitter Voltage | V_{CEO} | 80 | V |
| | 发射极-集电极电压 Emitter - Collector Voltage | V_{ECO} | 6 | V |
| 总功耗 Total Power Dissipation | | P_{tot} | 200 | mW |
| 工作温度 Operating Temperature | | T_{opr} | -55 ~ +110 | °C |
| 存储温度 Storage Temperature | | T_{stg} | -55 ~ +125 | °C |
| 焊接温度 Soldering Temperature | | T_{sol} | 260 | °C |

产品特性参数 Electro-optical Characteristics (Ta = 25°C)

| 参数 Parameter | | 符号 Symbol | 条件 Condition | 最小 Min. | 典型 Typ. | 最大 Max. | 单位 Unit |
|-------------------------------------|---|---------------|---|--------------------|--------------------|------------|---------------|
| 发射端 Input | 正向电压 Forward Voltage | V_F | $I_F = 20\text{mA}$ | - | 1.2 | 1.4 | V |
| | 反向电流 Reverse Current | I_R | $V_R = 4\text{V}$ | - | - | 10 | μA |
| | 输入电容 Terminal Capacitance | C_t | $V=0, F=1\text{kHz}$ | - | 30 | 250 | pF |
| 接收端 Output | 集电极暗电流 Collector Dark Current | I_{CEO} | $V_{CE} = 20\text{V}$ | - | - | 100 | nA |
| | 集电极-发射极击穿电压 Collector-Emitter Breakdown Voltage | BV_{CEO} | $I_C = 0.1\text{mA}, I_F = 0$ | 80 | - | - | V |
| | 发射极-集电极击穿电压 Emitter-Collector Breakdown Voltage | BV_{ECO} | $I_E = 10\mu\text{A}, I_F = 0$ | 6 | - | - | V |
| 传输特性 Transfer Characteristics | 电流传输比 Current Transfer Ratio | CTR* | $I_F = 5\text{mA}, V_{CE} = 5\text{V}$ | 80 | - | 600 | % |
| | 集电极-发射极饱和压降 Collector-Emitter Saturation Voltage | $V_{CE(sat)}$ | $I_F = 20\text{mA}, I_C = 1\text{mA}$ | - | 0.1 | 0.2 | V |
| | 隔离电阻 Isolation Resistance | R_{ISO} | $V_{I-O} = \text{DC}500\text{V}$ 40 ~ 60%R.H. | 5×10^{10} | 1×10^{11} | - | Ω |
| | 隔离电容 Isolation capacitance | C_{ISO} | $V=0, F=1\text{MHz}$ | - | 0.6 | 1.0 | pF |
| | 截至频率 Cut-off Frequency | F_C | $V_{CE} = 5\text{V}, I_C = 2\text{mA},$ $R_L = 100\Omega, -3\text{dB}$ | - | 80 | - | KHz |
| | 上升时间 Rise Time | T_r | $V_{CE} = 2\text{V}, I_C = 2\text{mA},$ $R_L = 100\Omega$ | - | 3 | 18 | μs |
| | 下降时间 Fall Time | T_f | $V_{CE} = 2\text{V}, I_C = 2\text{mA},$ $R_L = 100\Omega$ | - | 4 | 18 | μs |

 注*：电流传输比= $I_C/I_F \times 100\%$ 。

 Note*：CTR= $I_C/I_F \times 100\%$ 。

电流传输比分档表 CTR Classification Table ($I_F = 5\text{mA}, V_{CE} = 5\text{V}, T_a = 25^\circ\text{C}$)

| 代码 Code | 最小值 Min. | 最大值 Max. |
|---------|----------|----------|
| None | 80 | 600 |
| A | 80 | 160 |
| B | 130 | 260 |
| C | 200 | 400 |
| D | 300 | 600 |

典型光电特性曲线 Typical Electro-Optical Characteristics Curves

Fig.1 Relative Current Transfer Ratio vs. Forward Current

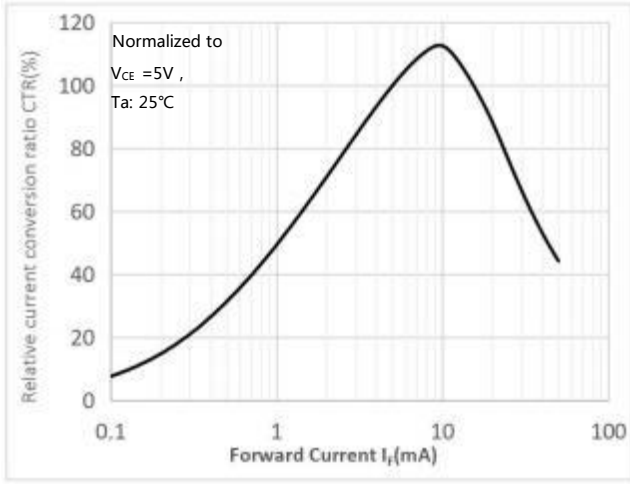

Fig.2 Forward Current vs. Forward Voltage

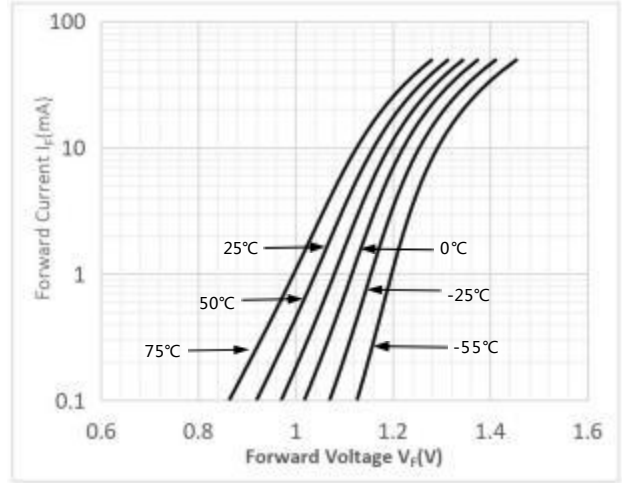

Fig.3 Collector Current vs. Collector-emitter Voltage

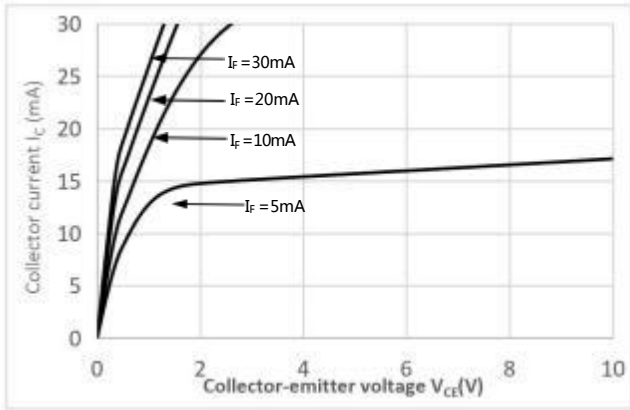

Fig.4 Relative Current Transfer Ratio vs. Ambient Temperature

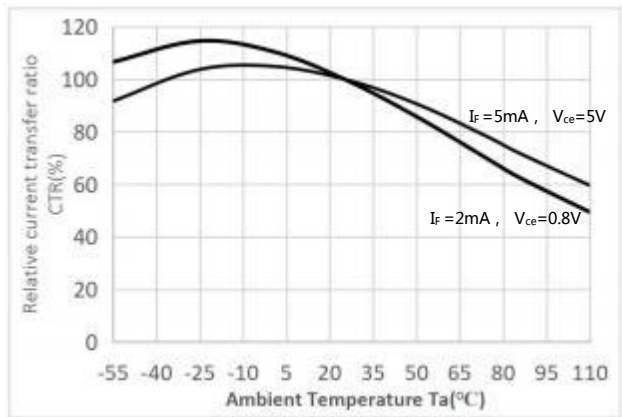

Fig.5 Collector-emitter Saturation Voltage vs. Ambient Temperature

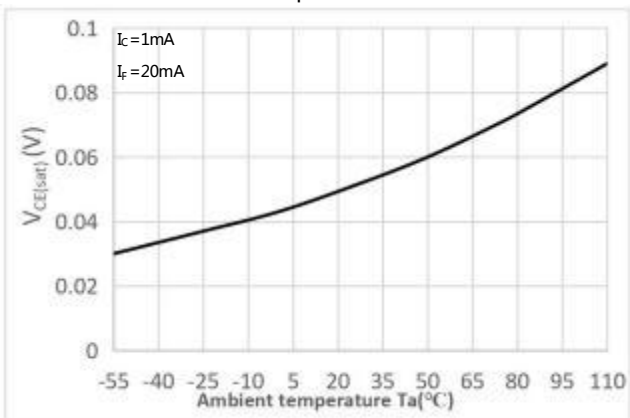

Fig.6 Collector Dark Current vs Ambient Temperature

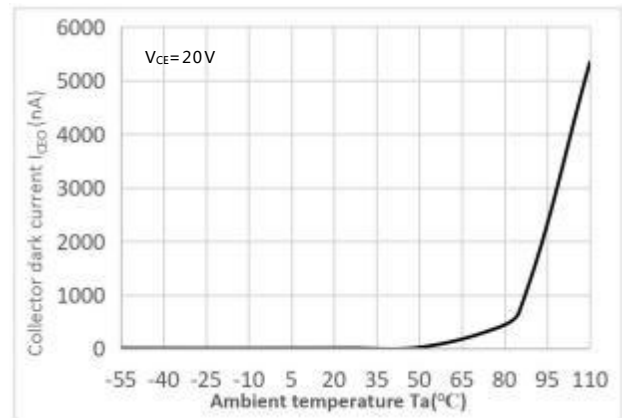

Fig.7 Response Time vs. Load Resistance

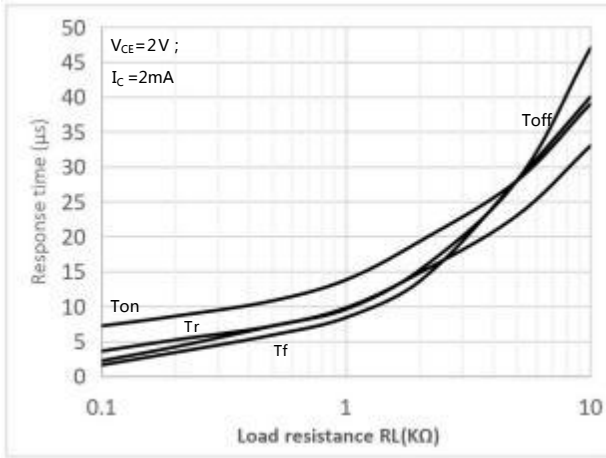

Fig.8 Frequency Response

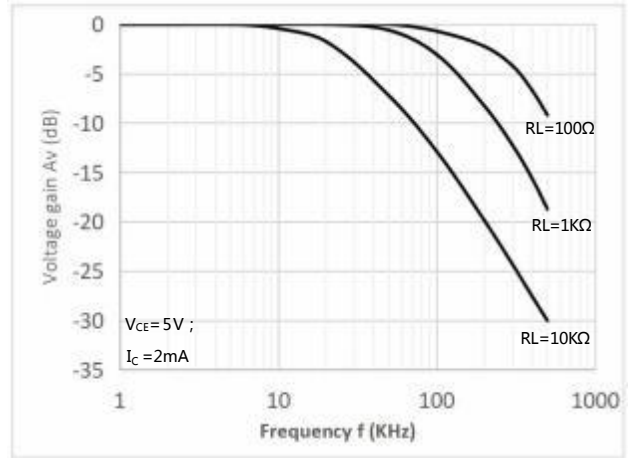

Fig.9 Frequency Response

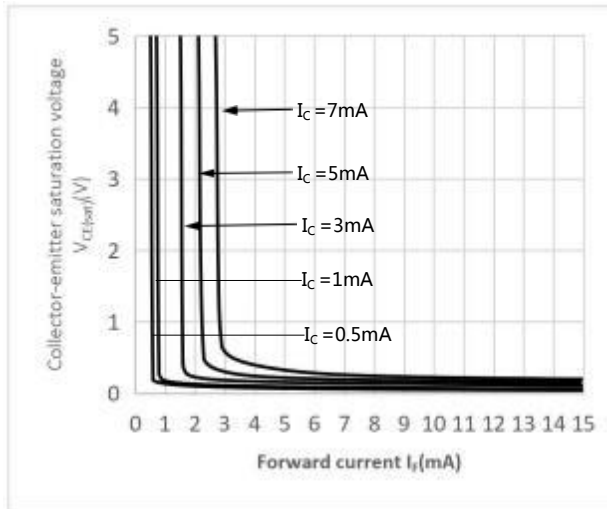
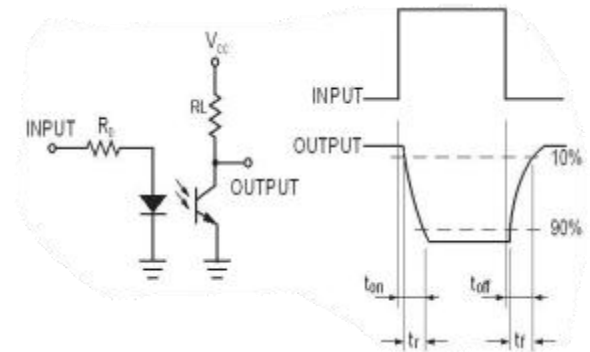
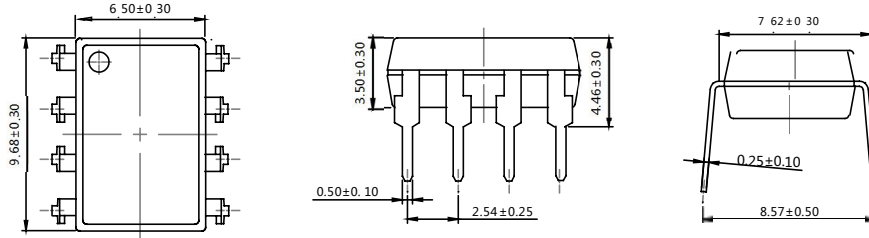

Fig.10 Switching Time Test Circuit & Waveforms



外形尺寸 Outline Dimensions

DIP8



SMD8

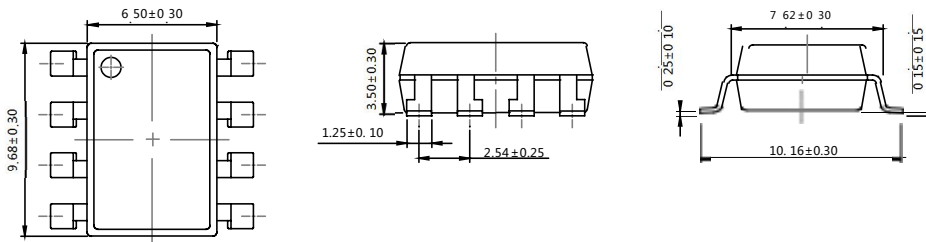

单位 Unit: mm

建议焊盘布局 Recommended Pad Layout

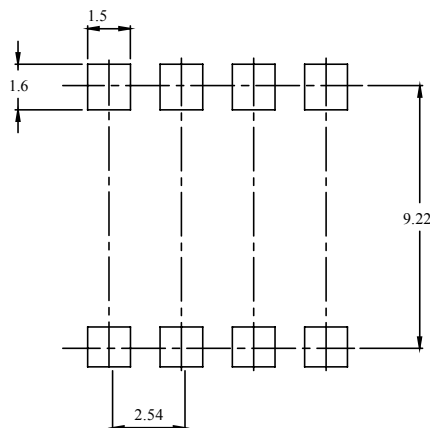

单位 Unit: mm

注：上图为产品正视图。

Note: The picture above is the front view of the product.

回流焊温度曲线图 Solder Reflow Profile



| 项目 Item | 符号 Symbol | 最小值 Min. | 最大值 Max. | 单位 Unit |
|---|----------------|-------------|-------------|------------|
| 预热温度 Preheat Temperature | Ts | 150 | 200 | °C |
| 预热时间 Preheat Time | ts | 60 | 120 | s |
| 升温速率 Ramp-Up Rate (T _L to T _p) | - | - | 3 | °C/s |
| 液相线温度 Liquidus Temperature | T _L | 217 | | °C |
| 时间高于 T _L Time Above T _L | t _L | 60 | 150 | s |
| 峰值温度 Peak Temperature | T _p | - | 260 | °C |
| Tc 在(T _p -5)和 T _p 之间的时间 Time During Which Tc Is Between (T _p -5) and T _p | t _p | - | 30 | s |
| 降温速率 Ramp-down Rate(T _p to T _L) | - | - | 6 | °C/s |

注 Note :

建议在所示的温度和时间条件下进行回流焊，最多不能超过三次；

Reflow soldering is recommended at the temperatures and times shown, no more than three times;

波峰焊温度曲线图 Wave Soldering Profile



手工烙铁焊接 Soldering with hand soldering iron

- A. 手工烙铁焊仅用于产品返修或样品测试；
Hand soldering iron is only used for product rework or sample testing;
- B. 手工烙铁焊要求：温度 $360^{\circ}\text{C} \pm 5^{\circ}\text{C}$ ，时间 $\leq 3\text{s}$ 。
Hand soldering iron requirements：Temperature： $360^{\circ}\text{C} \pm 5^{\circ}\text{C}$, within 3s.

包装 Packing

■ 汇总表 Summary table

| 封装形式 | 包装方式 | 盘数量 | 盒数量 | 箱数量 | 静电袋规格 | 盒规格 | 箱(双瓦楞)规格 | 备注 |
|--------------|-------------------------------|-------------------|------------------|---------------------|------------------------------|-------------------|----------------------|--|
| SMD8 | 卷盘 ($\phi 330$ mm 蓝盘) | 1000 只/盘 | 2 盘/盒 | 10 盒/箱 | 450*390*0.1mm | 340*60*340mm | 620*360*365mm | 首尾端空至少 200mm |
| DIP8 | 管装 (500*12*11mm) | 45 只/管 | 50 管/盒 | 10 盒/箱 | 不适用 | 525*128*56mm | 535*275*300mm | 每管使用蓝白胶 塞, 方向须一致 |
| Package Type | Packing Form | Quantity per Reel | Quantity per Box | Quantity per Carton | Antistatic Bag Specification | Box Specification | Carton Specification | Note |
| SMD8 | Reel ($\phi 330$ mm Blue) | 2000 pcs/reel | 2 reels/box | 10 boxes/ctn | 450*390*0.1mm | 340*60*340mm | 620*360*365mm | Guard band 200mm min. Endplug (blue) and Endplug (white) keep the direction |
| DIP8 | Tube (500*12*11mm) | 100 pcs /tube | 50 tubes/box | 10 boxes/ctn | NA | 525*128*56mm | 535*275*300mm | |

■ 编带包装 Tape & Reel

- 1) 每卷数量：2000 只。
Qty/reel：2000 pcs.
- 2) 每箱数量：40000 只。
Qty/ctn：40000 pcs.
- 3) 内包装：每盒 2 盘。
Inner packing：2 reels/box.
- 4) 示意图 Schematic：

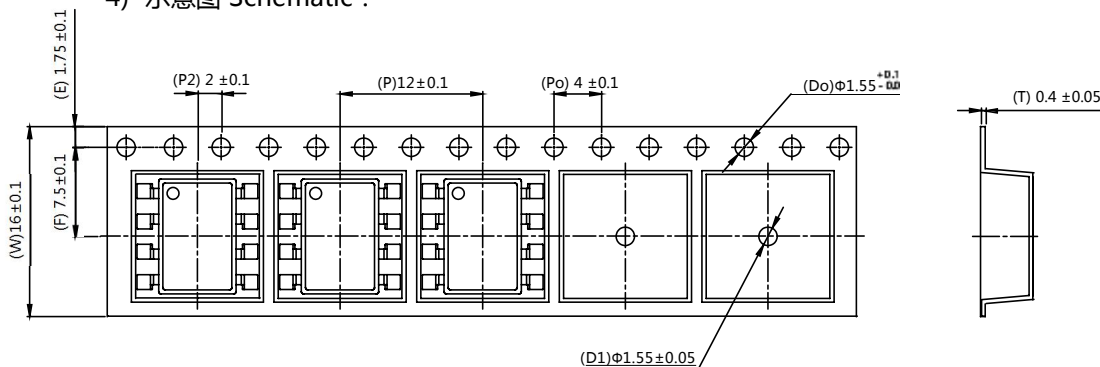

■ 管条包装 Tape & Tube

- 1) 每管数量：45 只。
Qty/Tube：45 pcs.
- 2) 每箱数量：22500 只。
Qty/ctn：22500 pcs.
- 3) 内包装：每盒 50 管。
Inner packing：50 Tube/box.
- 4) 示意图 Schematic：

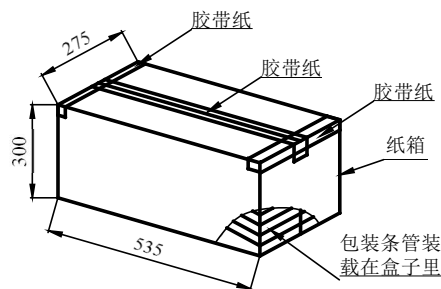

单位/Unit：mm

注意 Attention

- 奥特持续不断改进质量、可靠性、功能或设计，保留此文件更改的权利恕不另行通知。
AOTE continuously improve quality, reliability, function and design. We reserve the right to change this document without prior notice.
- 请遵守产品规格书使用，奥特不对使用时不符合产品规格书条件而导致的质量问题负责。
Please use in accordance with the product specification. AOTE is not responsible for the quality problems caused by non-compliance with the product specifications.
- 对于需要高可靠性或安全性的设备/装置需求，请联系我们的销售人员。
For equipment/devices requiring high reliability or safety, please contact our sales representatives.
- 当需要用于任何“特定”应用时，请咨询我们的销售人员。
When requiring a device for any “specific” application, please contact our sales in advice.
- 如对文件中表述的内容有疑问，欢迎联系我们。
If you have any questions about the contents of the document, please contact us.

X-ON Electronics

Largest Supplier of Electrical and Electronic Components

Click to view similar products for [Transistor Output Optocouplers](#) category:

Click to view products by [AOTE](#) manufacturer:

Other Similar products are found below :

[LTV-814S-TA](#) [LTV-852S](#) [66095-001](#) [PS2561-1-A](#) [PS2561A-1-W-A](#) [PS2561L1-1-A](#) [PS2561L-1-V-A](#) [PS2706-1-A](#) [PS2815-1-A](#) [MRF658](#)
[ELD207\(TA\)](#) [ILD2-X006](#) [ILQ615-3X016](#) [LDA102S](#) [SFH615A-4XSM TR](#) [PS2561DL-1Y-F3-A](#) [PS2561L1-1-L-A](#) [PS2562-1-V-A](#) [PS2565L-](#)
[1-A](#) [PS2581L2-A](#) [PS2701A-1-F3-P-A](#) [PS2711-1-A](#) [PS2801-1-F3-P-A](#) [PS2833-4-A](#) [PS2841-4A-AX](#) [LTV-702FS](#) [LTV-702V](#) [LTV-702VB](#)
[LTV-816S-TA](#) [TCET2100](#) [TLP290-4\(E\(T](#) [IL215AT](#) [WPPC-A11066AA](#) [WPPC-A11066AD](#) [WPPC-A11084ASS](#) [WPPC-A21068AA](#) [WPPC-](#)
[D11066AA](#) [WPPC-D21068ED](#) [WPPC-D410616EA](#) [WPPC-D410616ED](#) [X4IAC24A](#) [4N26-X001](#) [EL1010\(TA\)-VG](#) [SFH600-2X007](#)
[TCMT1118](#) [VO206AT](#) [WPPC-D21068EA](#) [WPPC-D11064AD](#) [WPPC-A410616AD](#) [WPPC-A21068AD](#)