

RoHS Comp.
Halogen Free

<h1>承認書</h1>
<h2>APPROVAL SHEET</h2>

Specifications description : CAP PL 470uF 16V ϕ 6.3*11.0 mm
DIP \pm 20%, 125°C 2000hrs

APAQ P/N : 160ARUP471M06A1E10

Customer P/N :

Date	Approved by	Checked by
	陳明宗	梁名琮

Approved by Customer
(Signing or stamping here) :

Approved Date :



鈺邦科技股份有限公司
APAQ TECHNOLOGY CO., LTD

竹南科學園區
苗栗縣竹南鎮科東三路 2&6 號 4 樓
4F., No. 2 & 6, Kedong 3rd Rd., Chunan
Science Park, Miaoli County 350,
Taiwan , (R.O.C.)

AP-CON ARUP SERIES SPECIFICATION

1. Application

This specification shall be specified to conductive polymer aluminum solid electrolytic capacitors of ARUP series.

2. Composition of part number

101 ARUP 471 M 10A2 EXX
 Rated voltage Series code Capacitance Cap tolerance Size code Special code

2.1 Rated voltage code

Table 1 Rated voltage and surge voltage

Rated voltage code	Rated voltage (V)	Surge voltage (V)
250	25	28.8
350	35	40.3
500	50	57.5
630	63	72.5
800	80	92

2.2 Capacitance code

Table 2 Rated capacitance

Capacitance code	Capacitance (uF)
3R3	3.3
100	10
471	470
122	1200

2.3 Capacitance tolerance code

Table 3 Capacitance tolerance

Cap tolerance code	Cap tolerance
M	±20%

THIS DRAWINGS AND SPECIFICATIONS ARE THE PROPERTY OF APAQ TECHNOLOGY CO. LTD AND SHALL NOT BE REPRODUCT OR USED AS THE BASIC FOR THE MANUFACTURE OR SALE OF APPARATUS OR DEVICES WITHOUT PERMISSION.



鈺邦科技股份有限公司

APAQ TECHNOLOGY CO., LTD

DESIGNED BY : 陳明宗

DRAWN BY : 呂姿儀

CHECKED BY : 梁名琮

APPROVED BY : 陳明宗

TITLE : AP-CON ARUP SERIES SPECIFICATION

DOCUMENT NO.

MES008947

REV

A0

2.4 Size code

Table 4 Dimension of radial type capacitors

Size code	Diameter (mm)	Case length (mm)
05X8	5	8
06X5	6.3	5
06X8	6.3	8
06A0	6.3	10
06A1	6.3	11
06A4	6.3	14
08X8	8	8
08A2	8	12
08A6	8	16
10A2	10	12
10A6	10	16

2.5 Special code

Size code	Remark
EXX	E10 : ESR 10 mΩ max

3. Rating

3.1 Category temperature range

-55 to +125 °C

3.2 Surge voltage

Rated voltage x 1.15

3.3 Rated ripple current

Rated ripple current shall be in accordance with standard ratings list. These current are rms values of sine wave of 100kHz at 125 °C.

THIS DRAWINGS AND SPECIFICATIONS ARE THE PROPERTY OF APAQ TECHNOLOGY CO. LTD AND SHALL NOT BE REPRODUCT OR USED AS THE BASIC FOR THE MANUFACTURE OR SALE OF APPARATUS OR DEVICES WITHOUT PERMISSION.



鈺邦科技股份有限公司

APAQ TECHNOLOGY CO., LTD

DESIGNED BY : 陳明宗

DRAWN BY : 呂姿儀

CHECKED BY : 梁名琮

APPROVED BY : 陳明宗

TITLE : AP-CON ARUP SERIES SPECIFICATION

DOCUMENT NO.

MES008947

REV

A0

3.4 Standard ratings

Table 5 Standard ratings

WV /Vdc (SV)	Cap (μ F)	Size Code	Leakage current (μ A)	$\tan\delta$	ESR ($m\Omega_{max}/20^{\circ}C$, 100k to 300kHz)	Rated ripple current (mA rms/100kHz)		Load life (125 $^{\circ}C$, Hours)	Part No.
						$\leq 105^{\circ}C$	105 $^{\circ}C <$ $\leq 125^{\circ}C$		
16 (18.4)	470	06A1	1,504	0.10	10	4,000	1,600	2,000	160ARUP471M06A1E10

3.5 Frequency correction factor of allowable ripple current

Frequency	120Hz $\leq f <$ 1kHz	1kHz $\leq f <$ 10kHz	10kHz $\leq f <$ 50kHz	50kHz $\leq f <$ 100kHz	100kHz $\leq f \leq$ 500kHz
Coefficient	0.05	0.3	0.7	0.85	1

THIS DRAWINGS AND SPECIFICATIONS ARE THE PROPERTY OF APAQ TECHNOLOGY CO. LTD AND SHALL NOT BE REPRODUCT OR USED AS THE BASIC FOR THE MANUFACTURE OR SALE OF APPARATUS OR DEVICES WITHOUT PERMISSION.



鈺邦科技股份有限公司

APAQ TECHNOLOGY CO., LTD

DESIGNED BY : 陳明宗

DRAWN BY : 呂姿儀

CHECKED BY : 梁名琮

APPROVED BY : 陳明宗

TITLE : AP-CON ARUP SERIES SPECIFICATION

DOCUMENT NO.

MES008947

REV

A0

4. Construction and dimensions.

4.1 Construction

Radial type capacitors shall be enclosed wound element, where anode and cathode foils with lead wire termination shall be wound together with separator, with conductive polymer electrolyte in a plastic coated aluminum case and sealed up tightly with rubber.

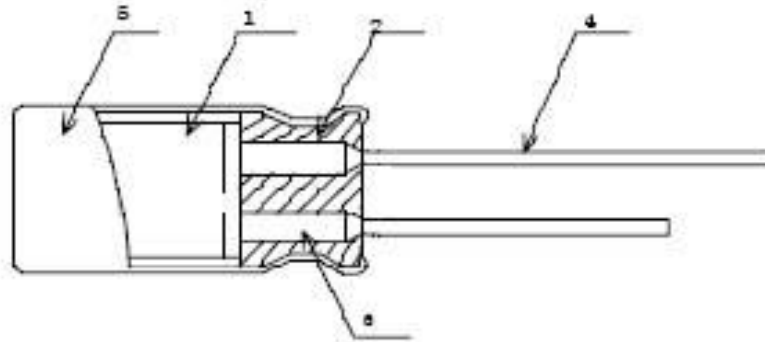

Fig. 1 Cross-section view

Table 6 Construction

Compositions		Materials
1	Anode foil	Aluminum
	Cathode foil	Aluminum
	Separator	Synthetic fiber
2	Seal	Rubber
3	Aluminum tab	Aluminum
4	Lead wire	Tinned Lead
5	Case	Plastic coated aluminum

4.2 Outer dimensions

Outer dimensions shall be in accordance with Fig. 2, and the dimensions in each size shall be specified on Table 7.

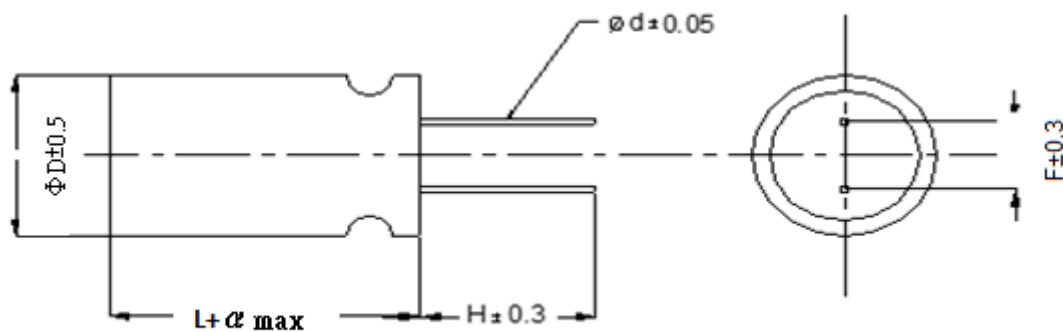

Fig. 2 Dimension

THIS DRAWINGS AND SPECIFICATIONS ARE THE PROPERTY OF APAQ TECHNOLOGY CO. LTD AND SHALL NOT BE REPRODUCE OR USED AS THE BASIC FOR THE MANUFACTURE OR SALE OF APPARATUS OR DEVICES WITHOUT PERMISSION.



鈺邦科技股份有限公司

APAQ TECHNOLOGY CO., LTD

DESIGNED BY : 陳明宗

DRAWN BY : 呂姿儀

CHECKED BY : 梁名琮

APPROVED BY : 陳明宗

TITLE : AP-CON ARUP SERIES SPECIFICATION

DOCUMENT NO.

MES008947

REV

A0

Table 7 Dimension

Size code	$\Phi D \pm 0.5$ (mm)	L (mm)	α (mm)	$\Phi d \pm 0.05$ (mm)	$F \pm 0.3$ (mm)	$H \pm 0.3$ (mm)
05X8	5	8	-0.5~1	0.5	2	3.2
06X5	6.3	5	-0.5~1	0.45	2.5	3.2
06X8	6.3	8	-0.5~1	0.6	2.5	3.2
06A0	6.3	10	-0.5~1	0.6	2.5	3.2
06A1	6.3	11	-0.5~1	0.6	2.5	3.2
06A4	6.3	14	-0.5~1	0.5	2.5	3.2
08X8	8	8	-0.5~1	0.6	3.5	3.2
08A2	8	12	-0.5~1	0.6	3.5	3.2
08A6	8	16	-0.5~1	0.6	3.5	3.2
10A2	10	12	-0.5~1	0.6	5	3.2
10A6	10	16	-0.5~1	0.6	5	3.2

5. Marking

The following items shall be marked on each capacitor, as showed in Fig. 3.

- (1) Polarity
- (2) Series
- (3) Year code: Z-2019,A-2020,B-2021
- (4) Production period code
- (5) Manufacturer's identification mark
- (6) Rated capacitance
- (7) Rated voltage
- (8) The color of marking ink is Red

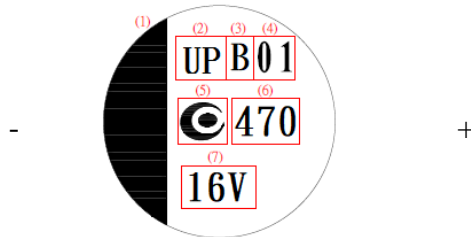

Figure 3 Marking

THIS DRAWINGS AND SPECIFICATIONS ARE THE PROPERTY OF APAQ TECHNOLOGY CO. LTD AND SHALL NOT BE REPRODUCT OR USED AS THE BASIC FOR THE MANUFACTURE OR SALE OF APPARATUS OR DEVICES WITHOUT PERMISSION.



鈺邦科技股份有限公司

APAQ TECHNOLOGY CO., LTD

DESIGNED BY : 陳明宗

DRAWN BY : 呂姿儀

CHECKED BY : 梁名琮

APPROVED BY : 陳明宗

TITLE : AP-CON ARUP SERIES SPECIFICATION

DOCUMENT NO.

MES008947

REV

A0

6. The electrical and mechanical performance and testing method

6.1 Measurement condition

Each measurement shall be conducted at a temperature of 15 to 35°C, and relative humidity of 45 to 85%. Furthermore, these measurements shall be preferably conducted at a temperature of 20±2 °C, and relative humidity of 60 to 70%, while the capacitors shall be kept enough time in the measuring temperature.

6.2 Voltage treatment

If leakage current is doubtful, measure it after performing voltage treatment, which shall contain the following steps:

- (1) Applied DC rated voltage to the capacitors for 60 minutes at 125±2 °C.
- (2) Cooled down to room temperature with applying voltage.
- (3) Discharged through a resistor of approximately 1Ω/V.

6.3 Electrical performance

6.3.1 Tolerance on rated capacitance

Rated capacitance shall meet within -20% to +20% (M) tolerance against the rated capacitance measured at 120Hz±10% at 20±2 °C.

6.3.2 Leakage current

DC rated voltage shall be applied between anode and cathode lead wire terminations of a capacitor through 1kΩ protective resistance, and the leakage current shall be less than or equal to the value listed in table 5 after 2 minutes with the voltage reaching the rated value at 20±2 °C.

If the value is doubtful, measure the leakage current after performing voltage treatment as described in section 6.2.

6.3.3 Tangent of loss angle (tanδ)

Tanδ values shall be less than or equal to 0.10 measured at 120Hz±10% at 20±2 °C.

6.3.4 Equivalent Series Resistance (ESR)

ESR at 100kHz measured under the following conditions listed in Table 8 shall be less than or equal to the value in Table 5.

THIS DRAWINGS AND SPECIFICATIONS ARE THE PROPERTY OF APAQ TECHNOLOGY CO. LTD AND SHALL NOT BE REPRODUCT OR USED AS THE BASIC FOR THE MANUFACTURE OR SALE OF APPARATUS OR DEVICES WITHOUT PERMISSION.



鈺邦科技股份有限公司

APAQ TECHNOLOGY CO., LTD

DESIGNED BY : 陳明宗

DRAWN BY : 呂姿儀

CHECKED BY : 梁名琮

APPROVED BY : 陳明宗

TITLE : AP-CON ARUP SERIES SPECIFICATION

DOCUMENT NO.

MES008947

REV

A0

Table 8 Measurement requirement of ESR

Equipment	Agilent Technology 4263B or equivalent
Test Fixture	Agilent Technology 16047E or equivalent
Compensation	Short and Open compensation would be required. Short correction is performed using the shorting plate made of 0.5 thickness copper plate with gold coating.
Signal Level	500mV
Frequency	100kHz
Measurement Point	Point of lead wire within 1mm form the body

6.3.5 Impedance at high and low temperature

Impedance at 100kHz at -55±3 °C or 125±2 °C shall meet the values listed in Table 9.

Table 9 Impedance at low or high temperature

Impedance ratio	Performance
Z(-55 °C)/Z(+20 °C)	≤ 1.25
Z(125 °C)/Z(+20 °C)	≤ 1.25

6.4 Mechanical performance

6.4.1 Pull strength of lead wire terminations

With the body of a capacitor fixed, the load listed in Table 10 shall be applied to the lead wire termination in its draw out direction, gradually up to the specified value and held for 10±1 seconds. After this test, that capacitor shall not appear any change defective in use.

Table 10 Pull strength load of lead wire terminations

Lead wire diameter (mm)	Load strength (N)	Load strength (kgf)
0.35<d ≤ 0.5	5	0.51
0.5<d ≤ 0.8	10	1.0

THIS DRAWINGS AND SPECIFICATIONS ARE THE PROPERTY OF APAQ TECHNOLOGY CO. LTD AND SHALL NOT BE REPRODUCT OR USED AS THE BASIC FOR THE MANUFACTURE OR SALE OF APPARATUS OR DEVICES WITHOUT PERMISSION.



鈺邦科技股份有限公司

APAQ TECHNOLOGY CO., LTD

DESIGNED BY : 陳明宗

DRAWN BY : 呂姿儀

CHECKED BY : 梁名琮

APPROVED BY : 陳明宗

TITLE : AP-CON ARUP SERIES SPECIFICATION

DOCUMENT NO.

MES008947

REV

A0

6.4.2 Bending strength of lead wire terminations

Bending strength load listed in Table 11 shall be hung at the end of the lead wire termination, and the body of a capacitor shall be bent 90° and return to its original position. This operation shall be performed around 2 to 3 seconds. Then the body shall be bent 90° at the opposite direction and return to its original position at same speed. At this test, that capacitor shall no appear any change defective in use.

Table 11 Bending strength load of lead wire terminations

Lead wire diameter (mm)	Load strength (N)	Load strength (kgf)
$0.35 < d \leq 0.5$	2.5	0.255
$0.5 < d \leq 0.8$	5	0.51

6.4.3 Solderability

A lead wire termination shall be dipped for 2 ± 0.5 seconds in the flux of ethanol or isopropylalcohol solution ($25 \pm 2\%$) of colophonium. Then that lead wire terminations shall be immersed to a solder (H60A, H60S or H63A) of 235 ± 5 oC and up to the point 1.5 to 2.0mm from the body and kept for 2 ± 0.5 seconds, and pulling it out. After this test, at least 95% of circumferential surface of the dipped portion of termination shall be covered with new solder..

6.4.4 Resistance to soldering heat

A Capacitor shall be inserted to a printed circuit board having a thickness of 1.6mm up to the point 1.5 to 2.0mm from the body. Then the lead wire termination shall be dipped for 5 to 10 seconds in the flux of ethanol solution ($25 \pm 2\%$) of colophonium. And then the lead wire termination shall be immersed to the solder (H60A, H60S or H63A) of 260 ± 5 °C and up to the point of the Printed circuit board and kept for 10 ± 1 seconds, and pulling it out. After this test, characteristics shall meet the value in Table 12.

Table12 Soldering heat resistance

Characteristics	Performance
Capacitance change	Within $\pm 5\%$ of the value before test
$\tan \delta$	Not exceed than the value in Table 5
Leakage current	Not exceed than the value in Table 5
Visual	No remarkable abnormality

THIS DRAWINGS AND SPECIFICATIONS ARE THE PROPERTY OF APAQ TECHNOLOGY CO. LTD AND SHALL NOT BE REPRODUCT OR USED AS THE BASIC FOR THE MANUFACTURE OR SALE OF APPARATUS OR DEVICES WITHOUT PERMISSION.



鈺邦科技股份有限公司

APAQ TECHNOLOGY CO., LTD

DESIGNED BY : 陳明宗

DRAWN BY : 呂姿儀

CHECKED BY : 梁名琮

APPROVED BY : 陳明宗

TITLE : AP-CON ARUP SERIES SPECIFICATION

DOCUMENT NO.

MES008947

REV

A0

6.4.5 Resistance to solvent

A Capacitor shall be immersed for 30±5 seconds in isopropylalcohol at 20 to 25°C and then pull it out. After this test, marking and visual shall meet the requirement in Table 13.

Table 13 Solvent resistance

Characteristics	Performance
Marking	Easily readable
Appearance	Not appear any abnormality

6.5 Environmental performance

6.5.1 Damp heat, steady state

A capacitor shall be subjected to a temperature of 60±2 °C and relative humidity of 90 to 95% without voltage applied for a period of 1000+24/-0 hours. Then that capacitor shall be take out from the above condition to a temperature of 20 °C and it shall meet the characteristics in Table 14.

Table 14 Damp heat performance

Characteristics	Performance
Appearance	No significant damage
Capacitance change	≤ ±20% of the initial value
tanδ	≤ 200% of the initial specified value
ESR	≤ 200% of the initial specified value
Leakage current	≤ the initial specified value

6.5.2 Endurance

A capacitor shall be subjected to a temperature of 125±2 °C with test voltage applied for a period of 2,000+72/-0 hours and take out from the above condition to a temperature of 20 °C. After this test, that capacitor shall meet the characteristics in Table 15.

Besides, the applied voltage shall increase up from 0V to test voltage step by step (maximum 5 minutes), and the impedance of the source shall be equal to about 3Ω/V.

Table 15 Endurance performance

Characteristics	Performance
Appearance	No significant damage
Capacitance change	≤ ±20% of the initial value
tanδ	≤ 200% of the initial specified value
ESR	≤ 200% of the initial specified value
Leakage current	≤ the initial specified value

THIS DRAWINGS AND SPECIFICATIONS ARE THE PROPERTY OF APAQ TECHNOLOGY CO. LTD AND SHALL NOT BE REPRODUCT OR USED AS THE BASIC FOR THE MANUFACTURE OR SALE OF APPARATUS OR DEVICES WITHOUT PERMISSION.



鈺邦科技股份有限公司

APAQ TECHNOLOGY CO., LTD

DESIGNED BY : 陳明宗

DRAWN BY : 呂姿儀

CHECKED BY : 梁名琮

APPROVED BY : 陳明宗

TITLE : AP-CON ARUP SERIES SPECIFICATION

DOCUMENT NO.

MES008947

REV

A0

6.5.3 Surge voltage

The following specifications in Table 16 shall be satisfied when the capacitors are restored to +20 °C after the surge voltage is applied at a cycle of 360 seconds which consists charge for 30±5 seconds through a protective resistor of 1kΩ and discharge for 330 seconds, for 2000 cycles at 125±2 °C.

Table 16 Surge voltage performance

Characteristics	Performance
Appearance	No significant damage
Capacitance change	≤ ±20% of the initial value
tanδ	≤ 200% of the initial specified value
ESR	≤ 200% of the initial specified value
Leakage current	≤ the initial specified value

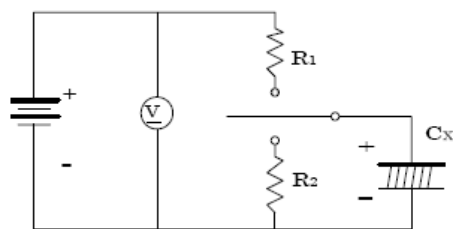

- Ⓟ :DC voltmeter
- R1 :Protective resistor 1kΩ
- R2 :Discharging resistor 1kΩ
- C_x :Capacitor under test

Fig. 5 Surge voltage circuit

6.5.4 Rapid temperature change

The characteristics of a capacitor kept under the temperature cycle indicated in Figure 6 for 5 cycles and followed the voltage treatment as described in section 6.2 shall meet the characteristics in Table 17.

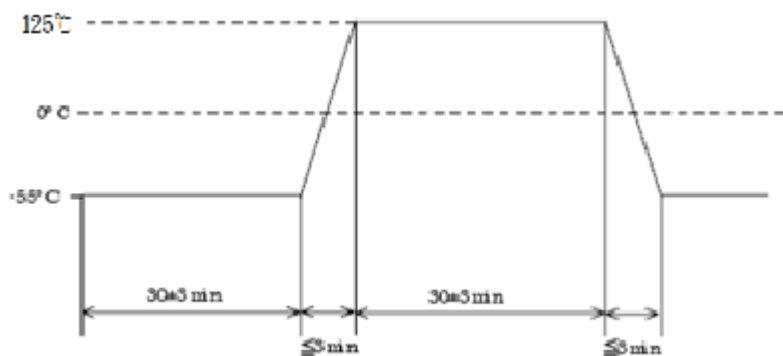

Fig. 6 Rapid temperature change profile

THIS DRAWINGS AND SPECIFICATIONS ARE THE PROPERTY OF APAQ TECHNOLOGY CO. LTD AND SHALL NOT BE REPRODUCT OR USED AS THE BASIC FOR THE MANUFACTURE OR SALE OF APPARATUS OR DEVICES WITHOUT PERMISSION.



鈺邦科技股份有限公司

APAQ TECHNOLOGY CO., LTD

DESIGNED BY : 陳明宗

DRAWN BY : 呂姿儀

CHECKED BY : 梁名琮

APPROVED BY : 陳明宗

TITLE : AP-CON ARUP SERIES SPECIFICATION

DOCUMENT NO.

MES008947

REV

A0

Table 17 Rapid temperature change performance

Characteristics	Performance
Appearance	No significant damage
Capacitance change	$\leq \pm 10\%$ of the initial value
$\tan\delta$	\leq the initial specified value
ESR	\leq the initial specified value
Leakage current	\leq the initial specified value

7. Instructions of Capacitors

7.1 Cautions on use of Capacitor

7.1.1 Polarity

Solid electrolytic capacitors are polarized capacitors. Use capacitors after verifying their positive and negative polarities. If these capacitors are installed in the reverse polarity, its life may shorten because of increasing leakage current or short circuit.

7.1.2 Types of circuits in which capacitors are prohibited from being used ARUP series may be heated by soldering to increase in its leakage current slightly. This may have some influence on the characteristics capacitors in the following circuits.

- (1) Time constant circuit
- (2) Coupling circuit
- (3) High impedance voltage holding circuit
- (4) Connection of two or more capacitors in series for higher withstand voltage.

7.1.3 Over voltage

If ARUP series is applied a voltage higher than the rated voltage for an instantaneous period, it may be defected due to short circuit. Note that the voltage over the rated voltage must not be applied to capacitors.

7.1.4 Repeat of rapid charging and discharging

If ARUP series is used in a rapid charging and discharging circuit or receive the flow of excess rush current, its life may shorten by large leakage current or short circuit. The charging and discharging current through ARUP series should be less than 10A.

7.1.5 Soldering

Capacitors should be soldered under the soldering conditions defined in the delivery specifications. Some improper soldering condition may cause the leakage current of capacitors to increase or other parameters to change.

THIS DRAWINGS AND SPECIFICATIONS ARE THE PROPERTY OF APAQ TECHNOLOGY CO. LTD AND SHALL NOT BE REPRODUCT OR USED AS THE BASIC FOR THE MANUFACTURE OR SALE OF APPARATUS OR DEVICES WITHOUT PERMISSION.



鈺邦科技股份有限公司

APAQ TECHNOLOGY CO., LTD

DESIGNED BY : 陳明宗

DRAWN BY : 呂姿儀

CHECKED BY : 梁名琮

APPROVED BY : 陳明宗

TITLE : AP-CON ARUP SERIES SPECIFICATION

DOCUMENT NO.

MES008947

REV

A0

7.1.6 Use of capacitors for industrial equipment

When capacitors are used for industrial equipment, the circuits should be designed to have sufficient margins in the ratings of capacitors including capacitance and impedance. Without sufficient margins in the characteristics, the reliability of the capacitors may be reduced by their shorter life. Always contact us if you want to use capacitors for equipment affecting human lives such as space, aviation, atomic power, and medical devices. Never use capacitors for the used without our prior approval.

7.2 Notes on circuit designs for capacitors

7.2.1 Rating and performance

Use capacitors within the rating and performance ranges defined in the brochures and delivery specification of capacitors after checking the operating and installation environments.

7.2.2 Operating temperature

If ARUP series is used at a temperature higher than the upper specified temperature (125°C), its life may be remarkably shortened or the leakage current may increase to cause defective.

7.2.3 Ripple current

Never make current larger than the rated ripple current through ARUP series. If excess ripple current flows through ARUP series, internal heat may be generated largely to make its life shortened or cause it to be defected due to short circuit.

7.2.4 Leakage current

Depending on the soldering conditions, the leakage current of ARUP series may increase slightly. The application of DC voltage enables the capacitors to be repaired by itself. This leads the leakage current to be smaller gradually. The leakage current can be reduced fast if the DC voltage, which is less than the rating voltage, is applied at the temperature close to the upper specified temperature.

7.2.5 Applied voltage

- (1) To secure the reliability of capacitors, it is recommended that the voltage applied to them should be less than 80% of the rated voltage.
- (2) The peak value of the ripple voltage superimposed with the DC voltage should be less than the rated voltage.

THIS DRAWINGS AND SPECIFICATIONS ARE THE PROPERTY OF APAQ TECHNOLOGY CO. LTD AND SHALL NOT BE REPRODUCT OR USED AS THE BASIC FOR THE MANUFACTURE OR SALE OF APPARATUS OR DEVICES WITHOUT PERMISSION.		 鈺邦科技股份有限公司 APAQ TECHNOLOGY CO., LTD	
DESIGNED BY : 陳明宗	DRAWN BY : 呂姿儀	CHECKED BY : 梁名琮	APPROVED BY : 陳明宗
TITLE : AP-CON ARUP SERIES SPECIFICATION		DOCUMENT NO. MES008947	REV A0

7.2.6 Failure mode

ARUP series contains a conductive polymer as material of cathode electrode. Therefore, like other solid electrolyte capacitors, the life ends mostly due to random failure mode, mainly short circuit. If a current continuously flow through the capacitor due to short circuit, the capacitor would be overheated higher than 300 °C and then aluminum case of the capacitor would be removed by increasing internal pressure due to the vaporization of materials.

7.2.7 Insulation

- (1) Plastic coated case of capacitors is not secured to insulate. Do not use capacitors in ARUPs requiring insulation.
- (2) Isolate the case of ARUP series from the positive and negative terminals and adjacent circuit patterns.

7.2.8 Design of printed circuit board

Take note on the following subjects when capacitors are installed on printed circuit boards:

- (1) Verify that the lead spacing fit hole pitches on printed circuit board.
- (2) Do not place heating components on boards to be close to capacitors or in the backside of them.
- (3) If capacitors are mounted on a double-sided PC board, design the board so that extra or through holes may not be opened below them.

7.2.9 Parallel connection

If ARUP series is connected with another type of a capacitor in parallel, larger ripple current may flow through one of capacitors. Take the current balance among them into account in circuit designs.

THIS DRAWINGS AND SPECIFICATIONS ARE THE PROPERTY OF APAQ TECHNOLOGY CO. LTD AND SHALL NOT BE REPRODUCT OR USED AS THE BASIC FOR THE MANUFACTURE OR SALE OF APPARATUS OR DEVICES WITHOUT PERMISSION.		 鈺邦科技股份有限公司 APAQ TECHNOLOGY CO., LTD	
DESIGNED BY : 陳明宗	DRAWN BY : 呂姿儀	CHECKED BY : 梁名琮	APPROVED BY : 陳明宗
TITLE : AP-CON ARUP SERIES SPECIFICATION		DOCUMENT NO. MES008947	REV A0

7.3 Notes on installation of capacitors

7.3.1 Notes on pre-installation of capacitors

- (1) Do not reuse capacitors installed in a unit with the power supply turned on for another unit. No used capacitors shall be reused excluding those removed to measure their electric characteristics in periodical inspection.
- (2) If ARUP series stored for a long period may often increase in its leakage current, connect a resistor of approximately $1k\Omega$ to the capacitors for voltage treatment.

7.3.2 Notes at installation of capacitors

- (1) Install capacitors in a unit after confirming that their ratings (rated capacitance and rated voltages) meet the conditions of the unit.
- (2) Install capacitors in the correct polarities.
- (3) Take care not to drop capacitors on floors. Do not use capacitors dropped on floors.
- (4) Do not deform capacitors to install them in units.
- (5) Install ARUP series on a printed circuit board after confirming that its lead pitch is equivalent to the corresponding hole pitch.
- (6) At the picking, mounting, and locating by an automatic inserter or the cutting of the leads of ARUP series by an automatic mounter, some stress may be applied to the ARUP series. Take note on the shock.
- (7) Do not apply any excess force with the terminals of capacitors.

7.3.3 Heating

In preheating or heating for adhesion and fixing of other electronic components, the temperature put to capacitors should be less than $120\text{ }^{\circ}\text{C}$. The total heating period should be shorter the 90 seconds.

7.3.4 Soldering by soldering iron

- (1) Capacitors should be soldered under the conditions as follows:
The iron tip at the temperature of $400\pm 10\text{ }^{\circ}\text{C}$ or less may be put to each lead of ARUP series for shorter than 3+1 seconds.
- (2) The lead wire terminations of capacitors may be required to be processed because the distance between the terminals is not equivalent to that of corresponding holes on the printed circuit board. Process the terminations so that no stress may be applied to the capacitors itself before soldering.
- (3) Do not make the tip of a soldering iron be in contact with capacitors themselves.

THIS DRAWINGS AND SPECIFICATIONS ARE THE PROPERTY OF APAQ TECHNOLOGY CO. LTD AND SHALL NOT BE REPRODUCT OR USED AS THE BASIC FOR THE MANUFACTURE OR SALE OF APPARATUS OR DEVICES WITHOUT PERMISSION.



鈺邦科技股份有限公司

APAQ TECHNOLOGY CO., LTD

DESIGNED BY : 陳明宗

DRAWN BY : 呂姿儀

CHECKED BY : 梁名琮

APPROVED BY : 陳明宗

TITLE : AP-CON ARUP SERIES SPECIFICATION

DOCUMENT NO.

MES008947

REV

A0

- (4) The leakage current of soldered capacitors may increase slightly depending on several conditions including pre-heating, soldering temperature and period, and board material and thickness. However, the leakage current decreases gradually by the self-repair characteristic of capacitors when they are used with voltage application.

7.3.5 Flow soldering

- (1) Do not dip capacitors themselves into melted solder in soldering. Only provide soldering for the board surface in the backside of the surface on which the capacitors are mount
- (2) Solder capacitors under the soldering conditions as follows.
 - (a) Pre-heat condition: atmosphere temperature 120°C or less for up to 90 seconds
 - (b) Soldering condition: solder temperature 260°C or less for up to 10 seconds.
- (3) Note that flux may not adhere to any substances except lead wires.
- (4) Do not make any other components fallen at capacitors in soldering.

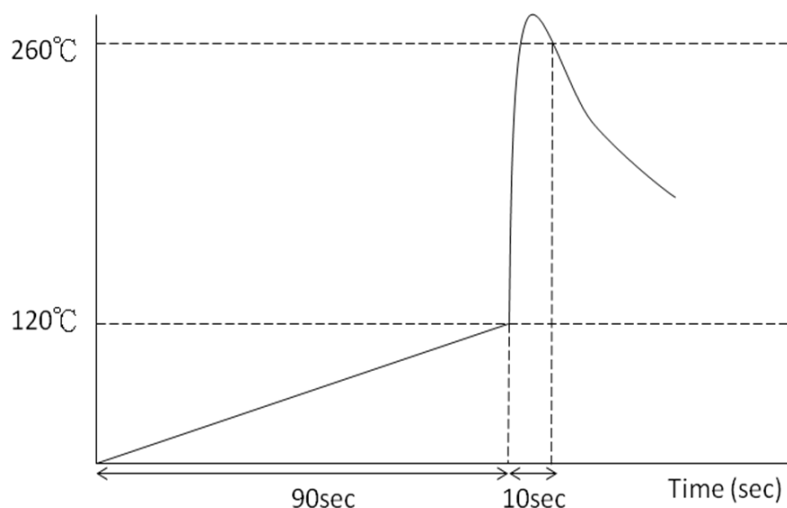

Figure 7 Flow Curve

7.3.6 Handling of capacitors after soldering

- (1) Do not incline, bend, and twist capacitors.
- (2) Do not grab capacitors as a handle to carry the printed circuit board.
- (3) Do not hit objects against capacitors. When printed circuit boards are piled up, do not make them and/or other components be in contact with capacitors.
- (4) Do not drop printed circuit boards with capacitors installed.

THIS DRAWINGS AND SPECIFICATIONS ARE THE PROPERTY OF APAQ TECHNOLOGY CO. LTD AND SHALL NOT BE REPRODUCT OR USED AS THE BASIC FOR THE MANUFACTURE OR SALE OF APPARATUS OR DEVICES WITHOUT PERMISSION.



鈺邦科技股份有限公司

APAQ TECHNOLOGY CO., LTD

DESIGNED BY : 陳明宗

DRAWN BY : 呂姿儀

CHECKED BY : 梁名琮

APPROVED BY : 陳明宗

TITLE : AP-CON ARUP SERIES SPECIFICATION

DOCUMENT NO.

MES008947

REV

A0

7.3.7 Cleaning of printed circuit board

As long as the cleaning agents prescribed in the catalogue or the specification sheet are used, the cleaning does not give the capacitors any damage. For CFCs substitutions and other cleaning agents, consult us before actual use.

7.3.8 Fixing and coating materials

Contact us for fixing and coating materials appropriate for capacitors and their heat curing conditions.

7.4 Notes on use of capacitors in unit

- (1) Never make your fingers contact with the lead wire terminations of capacitors.
- (2) Do not make lead wire terminations of ARUP series to be in contact with each other through an conductor. Do not put conductive liquid such as acid and alkali solutions on capacitors.
- (3) Confirm that the unit including capacitors is placed in proper conditions. Do not place the unit in the following ARUPs:
 - (a) ARUP in which they are directly exposed to water, brine, or oil or in condensation status.
 - (b) ARUP filled with poisonous gases including hydrogen sulfide, sulfurous acid, nitrous acid, chlorine and ammonia.
 - (c) ARUP to which ultraviolet and/or radial rays are radiated
- (4) Provide aging for a unit containing capacitors within the period defined for them.
- (5) It is recommended to use a unit containing capacitors in the normal temperature range of 15°C to 35°C and the normal humidity range of 75% or less.

7.5 Action at emergency

- (1) At the occurrence of short circuit in ARUP series, some heat is generated from it if the short-current rather small. If the short current exceeds the above value, the capacitor is heated excessively. If so, turn off the power of the unit without your face and hands being close to the capacitors.
- (2) Never lick the electrolyte of conductive polymer in capacitors. If the electrolyte is put on your skin, wash it away carefully with soap.
- (3) The materials of seal rubber used for capacitors are flammable. If an adjacent component is burned, seal rubber of the capacitors may burn. Take sufficient note on the installation procedures and locations of capacitors and the pattern designs of printed circuit boards.

THIS DRAWINGS AND SPECIFICATIONS ARE THE PROPERTY OF APAQ TECHNOLOGY CO. LTD AND SHALL NOT BE REPRODUCT OR USED AS THE BASIC FOR THE MANUFACTURE OR SALE OF APPARATUS OR DEVICES WITHOUT PERMISSION.



鈺邦科技股份有限公司

APAQ TECHNOLOGY CO., LTD

DESIGNED BY : 陳明宗

DRAWN BY : 呂姿儀

CHECKED BY : 梁名琮

APPROVED BY : 陳明宗

TITLE : AP-CON ARUP SERIES SPECIFICATION

DOCUMENT NO.

MES008947

REV

A0

7.6 Storage

- (1) Store capacitors in an ARUP in the temperature range between 15 °C to 35 °C and the relative humidity of 75% or less without direct sunshine. In addition, store them in the package states if possible.
- (2) Capacitors should be stored for up to three years to maintain their good soldering features and characteristics.
- (3) Capacitors are recommended that you shall open the bag just before use and capacitors shall be used up. If some quantity was not need, please seal it with adhesive tape.
- (4) Never store capacitors in any ARUP in which they are directly exposed to water, brine, or oil or in condensation status.
- (5) Never store capacitors in any ARUP filled with poisonous gases including hydrogen sulfide, sulfurous acid, nitrous acid, chlorine, and ammonia.
- (6) Never store capacitors in any ARUP to which ultraviolet and/or radial rays are radiated.

7.7 Exhaustion of capacitors

Capacitors are composed of organic compounds, resins and metals. Request an industrial dispose company to dispose of used Capacitors.

8. Export Trade Control Ordinance

Item 41-4 in Section 2 of Appendix Table 1 (Section 49 in Chapter 1 of MITI' s Ordinance) and Item 7 in Section 7 of Appendix Table 1 (Section 6 in Chapter 6 of MITI' s Ordinance) state export regulations on pulse use capacitors (750V of higher) and high voltage use capacitors (5,000V or higher).

However, aluminum electrolytic capacitors are less than 750V in their voltage range, so that the regulations do not apply to the aluminum electrolytic capacitors.

THIS DRAWINGS AND SPECIFICATIONS ARE THE PROPERTY OF APAQ TECHNOLOGY CO. LTD AND SHALL NOT BE REPRODUCT OR USED AS THE BASIC FOR THE MANUFACTURE OR SALE OF APPARATUS OR DEVICES WITHOUT PERMISSION.		 鈺邦科技股份有限公司 APAQ TECHNOLOGY CO., LTD	
DESIGNED BY : 陳明宗	DRAWN BY : 呂姿儀	CHECKED BY : 梁名琮	APPROVED BY : 陳明宗
TITLE : AP-CON ARUP SERIES SPECIFICATION		DOCUMENT NO. MES008947	REV A0

9. Package

The capacitors should be packed in the following quantities listed in Table 18.

Table 18 Quantity of package

Case size	PE bag	inner box	outer box
$\phi 5$	500 PCS	8 bags (4,000 PCS)	5 inner boxes (20,000 PCS)
06X5	500 PCS	12 bags (6,000 PCS)	5 inner boxes (30,000 PCS)
06X8	500 PCS	8 bags (4,000 PCS)	5 inner boxes (20,000 PCS)
06A0	500 PCS	6 bags (3,000 PCS)	5 inner boxes (15,000 PCS)
06A1	500 PCS	6 bags (3,000 PCS)	5 inner boxes (15,000 PCS)
06A4	500 PCS	6 bags (3000 PCS)	5 inner boxes (15000 PCS)
08X8	500 PCS	6 bags (3,000 PCS)	5 inner boxes (15,000 PCS)
08A2	500 PCS	4 bags (2,000 PCS)	5 inner boxes (10,000 PCS)
08A6	500 PCS	4 bags (2,000 PCS)	5 inner boxes (10,000 PCS)
10A2	500 PCS	4 bags (2,000 PCS)	5 inner boxes (10,000 PCS)
10A6	400 PCS	4 bags (1,600 PCS)	5 inner boxes (8,000 PCS)

THIS DRAWINGS AND SPECIFICATIONS ARE THE PROPERTY OF APAQ TECHNOLOGY CO. LTD AND SHALL NOT BE REPRODUCE OR USED AS THE BASIC FOR THE MANUFACTURE OR SALE OF APPARATUS OR DEVICES WITHOUT PERMISSION.



鈺邦科技股份有限公司

APAQ TECHNOLOGY CO., LTD

DESIGNED BY : 陳明宗

DRAWN BY : 呂姿儀

CHECKED BY : 梁名琮

APPROVED BY : 陳明宗

TITLE : AP-CON ARUP SERIES SPECIFICATION

DOCUMENT NO.

MES008947

REV

A0

X-ON Electronics

Largest Supplier of Electrical and Electronic Components

Click to view similar products for [Aluminium Organic Polymer Capacitors](#) category:

Click to view products by [APAQ](#) manufacturer:

Other Similar products are found below :

[750-1809](#) [SEAU0A0102G](#) [MPP104K6130714LC](#) [MPP223J5130508LC](#) [MPP104K6130612LC](#) [MPP684K4241219LC](#) [PPS333KD241017LC](#)
[MPP472K4130408LC](#) [PCZ1V221MCL1GS](#) [HHXD500ARA470MHA0G](#) [NPXB1001B271MF](#) [NPXB1101B391MF](#) [NPXC0571B221MF](#)
[NPXC0701B331MF](#) [NPXB0901B391MF](#) [NPXD0701A471MF](#) [HHXD630ARA330MJA0G](#) [HHXD350ARA270MF61G](#)
[HHXD350ARA220ME61G](#) [HHXD350ARA101MHA0G](#) [HHXD350ARA680MF80G](#) [APXJ200ARA151MF61G](#) [RS81C271MDN1CG](#)
[APSF6R3ELL821MF08S](#) [PM101M016E058PTR](#) [PM101M025E077PTR](#) [SPZ1EM221E10P25RAXXX](#) [APSE2R5ETD821MF08S](#)
[SPZ1EM681F14O00RAXXX](#) [SPZ1AM102F11000RAXXX](#) [SPV1VM471G13O00RAXXX](#) [SPZ1VM821G18O00RAXXX](#)
[SPV1HM331G15O00RAXXX](#) [SVZ1EM221E09E00RAXXX](#) [PM101M035E077PTR](#) [HV1A227M0605PZ](#) [HV1C107M0605PZ](#)
[HV1C227M0607PZ](#) [HV1H107M0810PZ](#) [HV1E107M0607PZ](#) [HV1V106M0605PZ](#) [HV1V476M0605PZ](#) [HV1H227M1010PZ](#)
[HV0J337M0607PZ](#) [HV1A477M0607PZ](#) [HV1E566M0605PZ](#) [HV1V227M0810PZ](#) [HV0J108M0810PZ](#) [M2101M035C070RT](#)
[SVZ1EM471FBRE00RAXXX](#)